

2-CHANNEL ELECTRONIC VOLUME

■ GENERAL DESCRIPTION

The NJU72344 is a 2 channels electronic volume IC.

The NJU72344 has many characteristics that are useful in audio application, such as low noise, low distortion, and wide operating voltage range.

All functions are controlled by 2-wired serial BUS interface.

■ PACKAGE OUTLINE

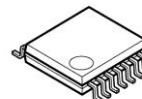

NJU72344V

■ FEATURES

- Operating Voltage ±4.5 to ±7.5V
- Volume 0 to -95dB/1dBstep, Mute
0, +3, +6, +12, +18, +24dB
- Low Distortion 0.001% typ.
- Low Noise -114dBV typ.
- External Mute Control
- Zero Cross Detection
- 2-wired serial BUS Control
- CMOS Technology
- Package SSOP14

■ BLOCK DIAGRAM

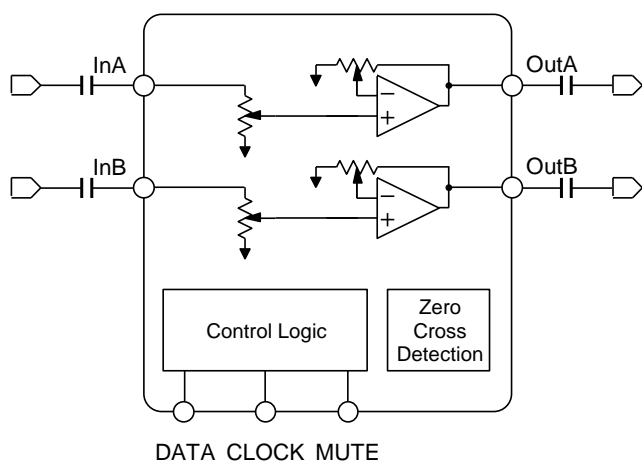

■ PIN CONFIGURATION

No.	Symbol	Function
1	NC	No Connect
2	NC	No Connect
3	InA	Ach Input Terminal
4	InB	Bch Input Terminal
5	MUTE	Mute Control Terminal
6	DATA	Control Data Signal Input Terminal
7	CLOCK	Clock Signal Input Terminal
8	V+	Power Supply (+)
9	REF	Reference Voltage Terminal
10	V-	Power Supply (-)
11	OutB	Bch Output Terminal
12	OutA	Ach Output Terminal
13	NC	No Connect
14	NC	No Connect

■ABSOLUTE MAXIMUM RATING (Ta=25°C)

PARAMETER	SYMBOL	RATING	UNIT
Supply Voltage	V ⁺ /V ⁻	±8	V
Maximum Input Voltage	V _{IM}	V ⁺ /V ⁻	V
Power Dissipation	P _D	450 NOTE: EIA/JEDEC STANDARD Test board (76.2x114.3x1.6mm, 2layer, FR-4) mounting	mW
Operating Temperature Range	Topr	-40 to +85	°C
Storage Temperature Range	Tstg	-40 to +125	°C

■RECOMMENDED OPERATING VOLTAGE RANGE (Ta=25°C unless otherwise specified)

PARAMETER	SYMBOL	TEST CONDITION	MIN.	TYP.	MAX.	UNIT
Operating Voltage	V ⁺ /V ⁻		±4.5	±7.0	±7.5	V

■ELECTRICAL CHARACTERISTICS

(Ta=25°C, V⁺/V⁻=±7V, R_L=47kΩ, V_{IN}=2Vrms, f=1kHz, Gain=0dB, Volume=0dB unless otherwise specified)

◆DC CHARACTERISTICS

PARAMETER	SYMBOL	TEST CONDITION	MIN.	TYP.	MAX.	UNIT
Supply Current 1	I _{DD}	No signal (V ⁺)	-	3	5	mA
Supply Current 2	I _{SS}	No signal (V ⁻)	-	3	5	mA

◆AC CHARACTERISTICS

PARAMETER	SYMBOL	TEST CONDITION	MIN.	TYP.	MAX.	UNIT
Maximum Input Voltage	V _{IM}	Volume=-20dB, THD=1%	4.7	-	-	Vrms
Maximum Output Voltage	V _{OM}	THD=1%	3.6	4.2	-	Vrms
Voltage Gain 1	G _{V1}	Gain=6dB, V _{IN} =100mVrms	+4	+6	+8	dB
Voltage Gain 2	G _{V2}		-1.5	0	+1.5	dB
Voltage Gain Error	ΔG _V		-1	0	+1	dB
Maximum Attenuation	A _{TT}	Volume=Mute, A-weight	-	-108	-	dB
Total Harmonic Distortion	THD	V _{IN} =1Vrms, BW=400Hz~30kHz	-	0.001	0.01	%
Output Noise Voltage	V _{NO}	R _g =0Ω, A-weight	-	-114 (2μ)	-103 (7μ)	dBV (Vrms)
Channel Separation	CS	R _g =0Ω, Bandpass	-	-110	-90	dB

■LOGIC CONTROL CHARACTERISTICS (Ta=25°C, unless otherwise specified)

PARAMETER	SYMBOL	TEST CONDITION	MIN.	TYP.	MAX.	UNIT
High Level Input Voltage 1	V _{IH1}	MUTE terminal	2.5	-	V ⁺	V
Low Level Input Voltage 1	V _{IL1}	MUTE terminal	0	-	1.0	V
High Level Input Voltage 2	V _{IH2}	DATA, CLOCK terminal	2.5	-	5.5	V
Low Level Input Voltage 2	V _{IL2}	DATA, CLOCK terminal	0	-	1.0	V

■ TERMINAL DESCRIPTION

Terminal	SYMBOL	FUNCTION	EQUIVALENT CIRCUIT	VOLTAGE
3 4	InA InB	Ach Input Bch Input		0V
5	MUTE	Mute Control		0V
6 7	DATA CLOCK	Control DATA Signal Input Clock Signal Input		-
9	REF	Reference Voltage		0V
11 12	OutB OutA	Bch Output Ach Output		0V

NJU72344

TEST CIRCUIT

◆ I_{DD}/I_{SS}

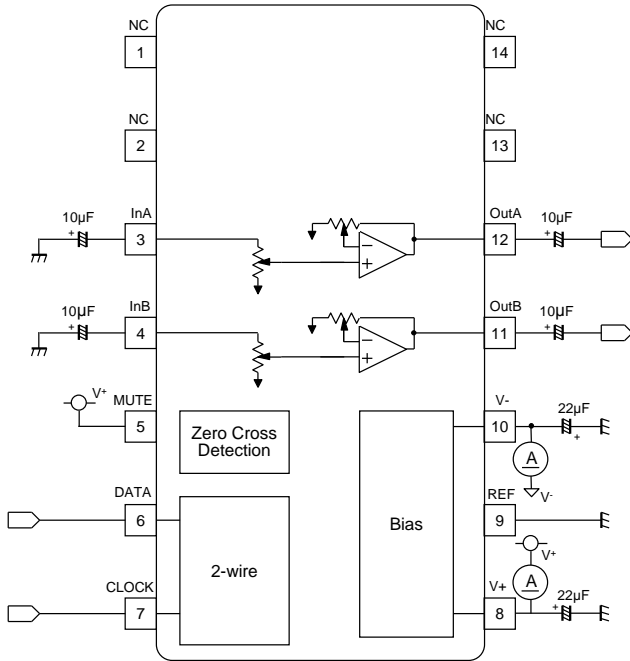

◆ V_{NO}

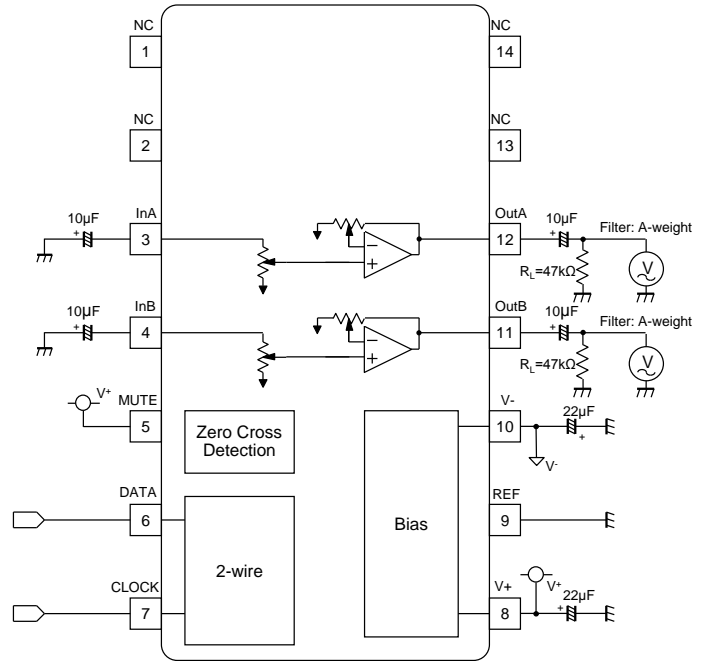

◆THD

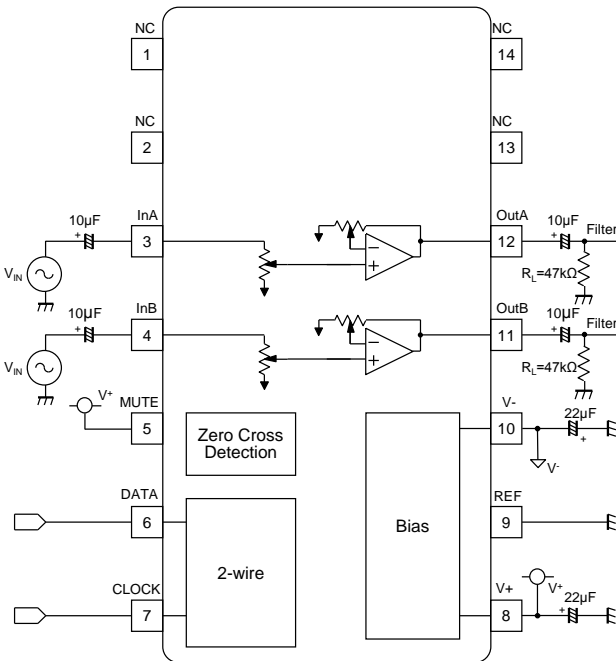

◆CS

Ex) Input=InB -> Measure=OutA
Input=InA -> Measure=OutB

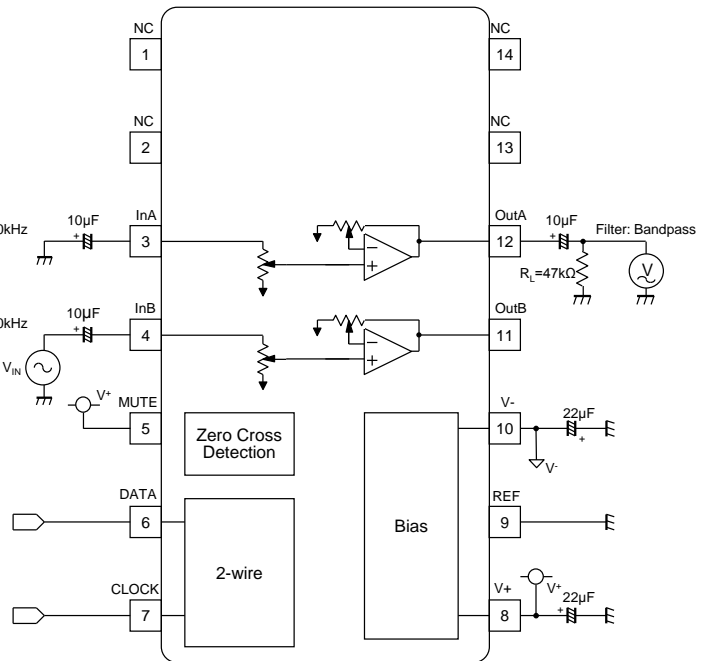

APPLICATION CIRCUIT

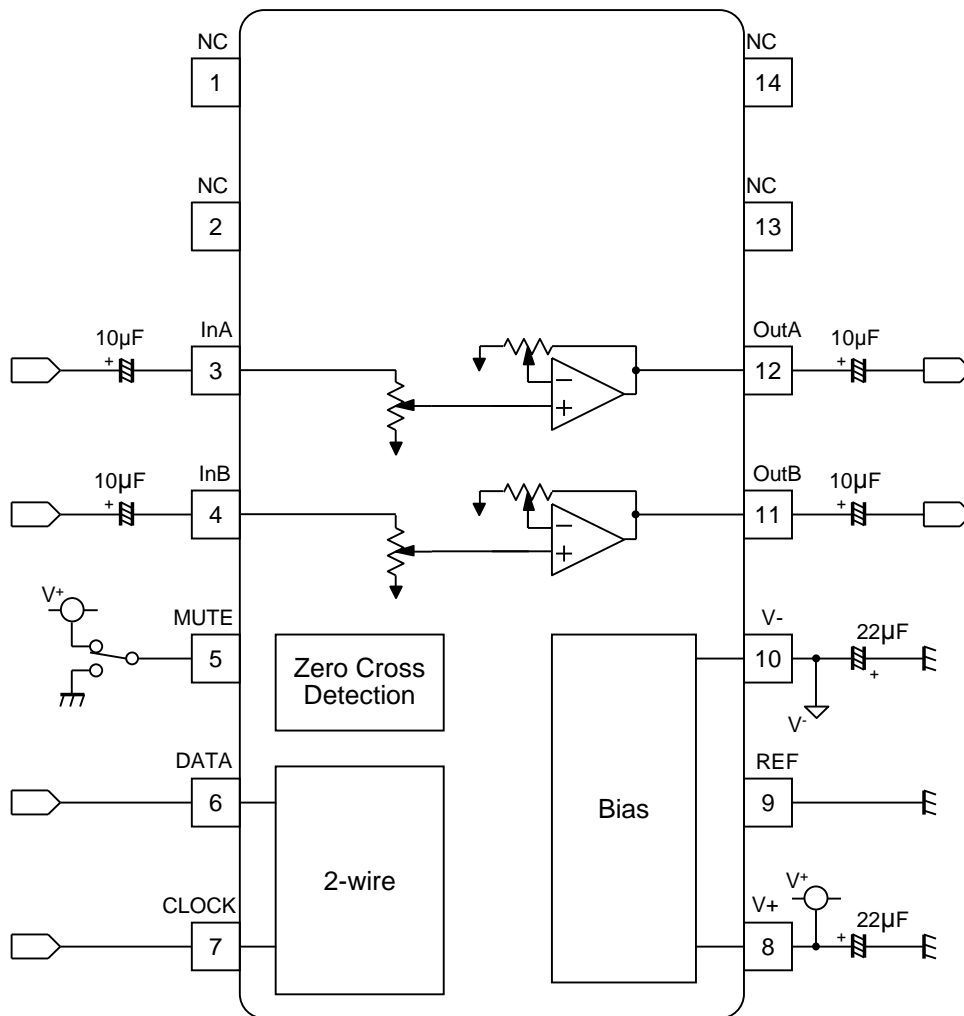

■TIMING ON 2-wire SERIAL BUS CONTROL (DATA, CLOCK)

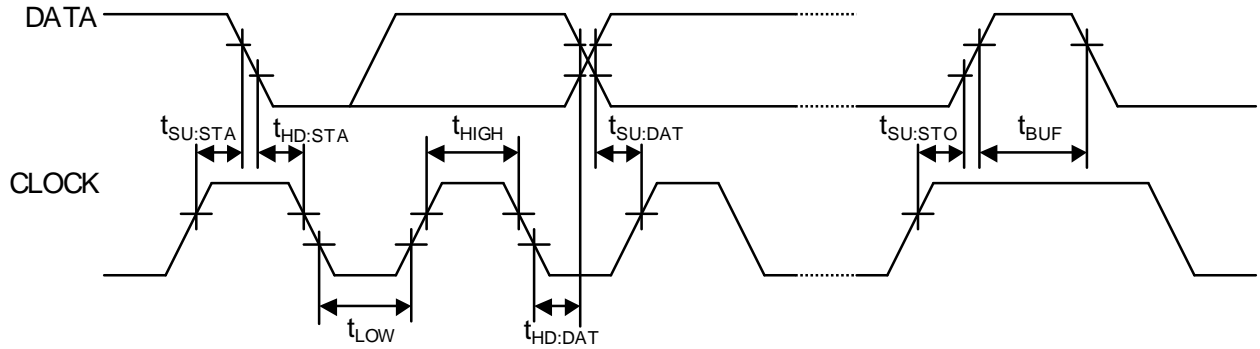

■CHARACTERISTICS OF I/O STAGES FOR 2-wire SERIAL BUS (DATA,CLOCK)

PARAMETER	SYMBOL	MIN.	TYP.	MAX.	UNIT
t_{HD_STA}	Hold time (repeated) START condition.	4	-	-	μs
t_{LOW}	Low period of the CLOCK clock	2	-	-	μs
t_{HIGH}	High period of the CLOCK clock	2	-	-	μs
t_{SU_STA}	Set-up time for a repeated START condition	2	-	-	μs
t_{HD_DAT}	Data hold time	1	-	-	μs
t_{SU_DAT}	Data set-up time	1	-	-	μs
t_{SU_STO}	Set-up time for STOP condition	2	-	-	μs
t_{BUF}	Bus free time between a STOP and START condition	4	-	-	μs

■RECOMMENDED POWER-UP SEQUENCE

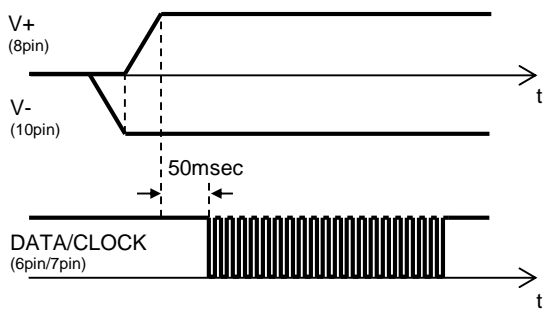

■ CONTROL DATA

◆ 2-wire SERIAL BUS FORMAT

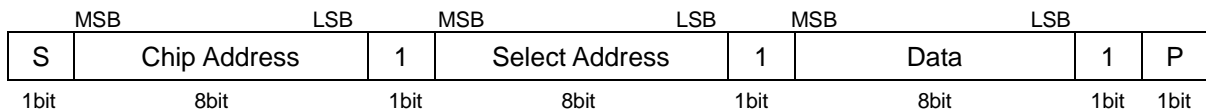

S: Starting Term

P: Ending Term

◆ Chip Address

Chip Address								Hex
MSB							LSB	-
1	0	0	0	0	1	0	0	88(h)

◆ Select Address

The select address sets each function (Gain, Volume, Zero Cross).

The auto increment function cycles the select address as follows.

00H→01H→02H→00H

	MSB							LSB
Select Address	Data							
	D7	D6	D5	D4	D3	D2	D1	D0
00H	*	*	*	*	*	GAIN		
01H	ZERO A		VOLUME A					
02H	ZERO B		VOLUME B					

*: Don't Care

◆ Hardware Mute

The mute function can be controlled externally. If the MUTE terminal (5pin) is switched to Low, outputs are muted immediately.

External mute control terminal (MUTE: 5pin)	Setting
Low	Mute
High	Mute Cancellation

■ INITIAL CONDITION OF CONTROL REGISTER

	MSB							LSB
Select Address	Data							
	D7	D6	D5	D4	D3	D2	D1	D0
00H	0	0	0	0	0	0	0	0
01H	0	0	0	0	0	0	0	0
02H	0	0	0	0	0	0	0	0

Note.) This product starts up by MUTE setting in power "ON". Use it after removing MUTE of each setting.

If any audio signal is inputted in input signal terminal before power "ON", it may cause initial condition abnormality.

In conditions of use such as the above, it prevents that abnormality by setting MUTE before power "OFF"

■ DEFINITION OF RESISTOR

◆ **GAIN:** 0, +3, +6, +12, +18, +24dB. Ach and Bch are simultaneous control.

Select Address	Data						D2	D1	D0
	D7	D6	D5	D4	D3	D2			
00H	*	*	*	*	*	GAIN			

<GAIN Control Data>

Data			Setting
D2	D1	D0	
0	0	0	0dB (*)
0	0	1	+3dB
0	1	0	+6dB
0	1	1	+12dB
1	0	0	+18dB
1	0	1	+24dB

*: Default Value

- ◆ **ZERO A/B:** Ach/Bch Zero Cross Detection ON/OFF setting.
- ◆ **VOLUME A/B:** Volume A/B setting 0 to -95 dB (1dB/Step) / Mute. Each volume is controlled independently.

Select Address	MSB	Data						LSB
	D7	D6	D5	D4	D3	D2	D1	D0
01H	ZERO A	VOLUME A						
02H	ZERO B	VOLUME B						

<ZERO A/B Control Data>

Data D7	Setting
0	OFF (*)
1	ON

*: Default Value

< VOLUME Control Data >

Data							Setting
D6	D5	D4	D3	D2	D1	D0	
1	1	1	1	1	1	1	Mute
...							...
1	1	1	1	0	0	0	Mute
1	1	1	0	1	1	1	0dB
1	1	1	0	1	1	0	-1dB
1	1	1	0	1	0	1	-2dB
1	1	1	0	1	0	0	-3dB
1	1	1	0	0	1	1	-4dB
1	1	1	0	0	1	0	-5dB
1	1	1	0	0	0	1	-6dB
...							...
0	0	1	1	1	0	1	-90dB
0	0	1	1	1	0	0	-91dB
0	0	1	1	0	1	1	-92dB
0	0	1	1	0	1	0	-93dB
0	0	1	1	0	0	1	-94dB
0	0	1	1	0	0	0	-95dB
0	0	1	0	1	1	1	Mute
...							...
0	0	0	0	0	0	0	Mute(*)

(*)Initial Setting

TYPICAL CHARACTERISTICS

Supply Current 1 vs Supply Voltage
No signal, No load

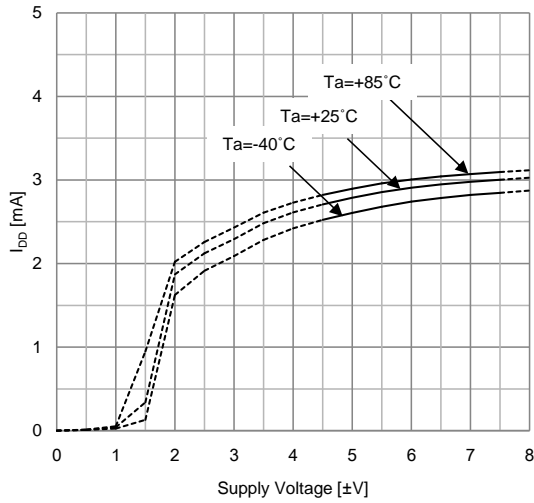

Supply Current 2 vs Supply Voltage
No signal, No load

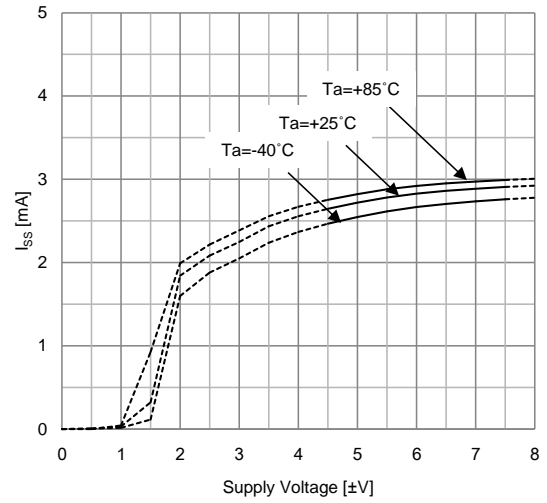

Maximum Output Voltage vs Supply Voltage
f=1kHz, THD=1%

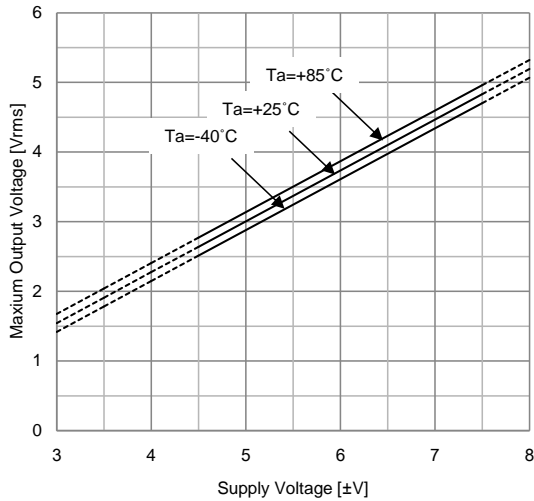

Output Voltage vs Load Resistance
V=±7V, f=1kHz, Vin=4.2Vrms

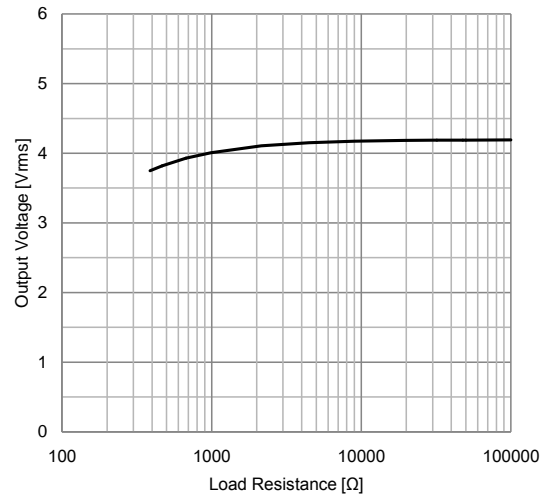

Output Voltage Gain vs Frequency

V=±7V, Vin=2Vrms(VOL=0,-50,-95dB,Mute),
Vin=0.1Vrms(VOL=+12,+24dB), Bandpass

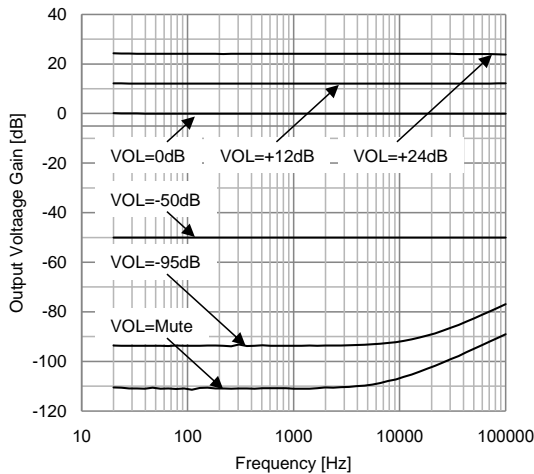

Output Voltage Gain vs Volume Setting

V=±7V, Vin=2Vrms(VOL=0,-50,-95dB,Mute),
Vin=0.1Vrms(VOL=+12,+24dB), Bandpass

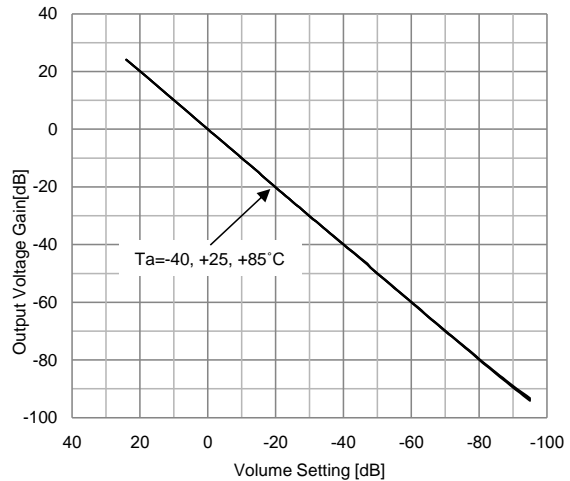

TYPICAL CHARACTERISTICS

THD+N vs Input Voltage
 $V = \pm 7V$, BW: 22Hz-30kHz

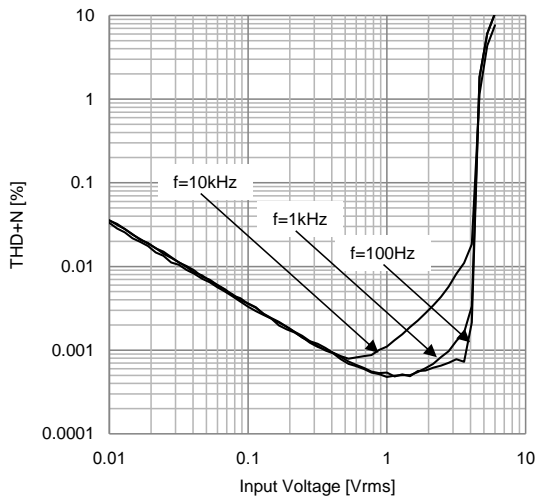

THD+N vs Input Voltage
 $V = \pm 7V$, $f = 1kHz$, BW: 400Hz-30kHz

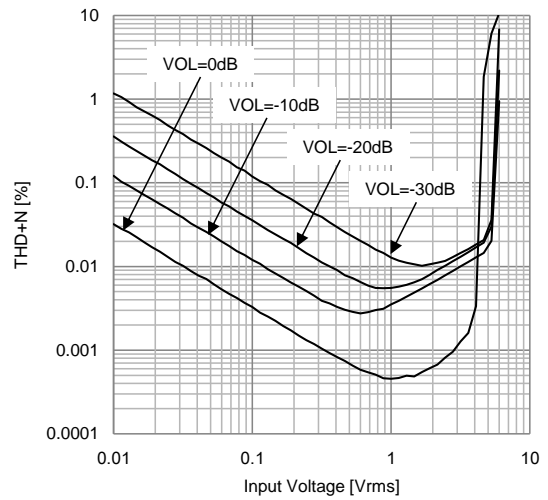

THD+N vs Frequency
 $V = \pm 7V$, BW: 22Hz-80kHz

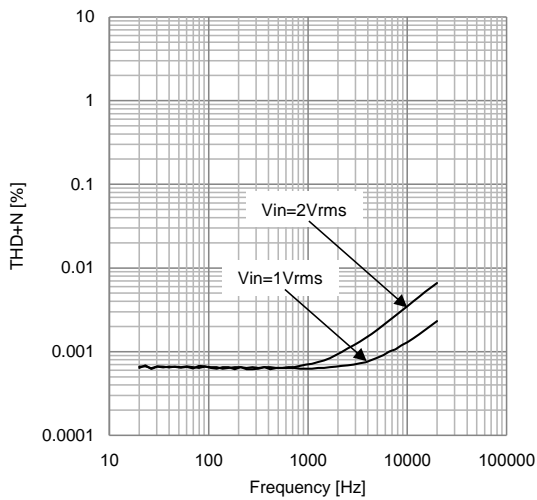

Channel Separation vs Frequency
 $V = \pm 7V$, $V_{in} = 2V_{rms}$, Bandpass,
 $I/O = InB-OutA$, $R_g = InA$

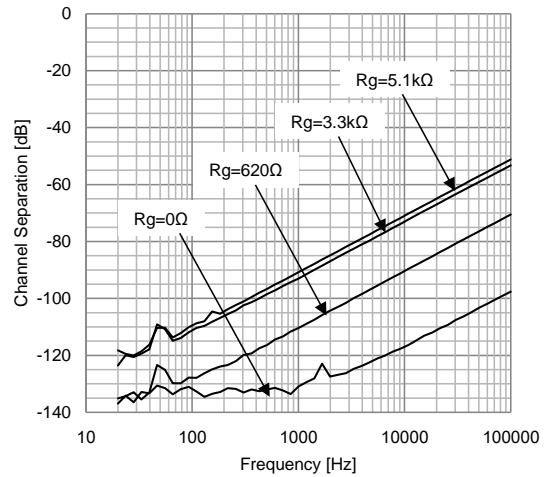

Output Voltage vs Mute Terminal Voltage
 $V = \pm 7V$, $f = 1kHz$, $V_{in} = 1V_{rms}$

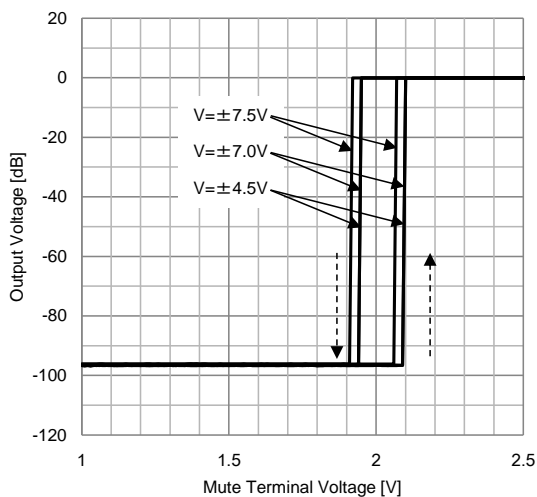

Output Voltage vs Mute Terminal Voltage
 $V = \pm 7V$, $f = 1kHz$, $V_{in} = 1V_{rms}$

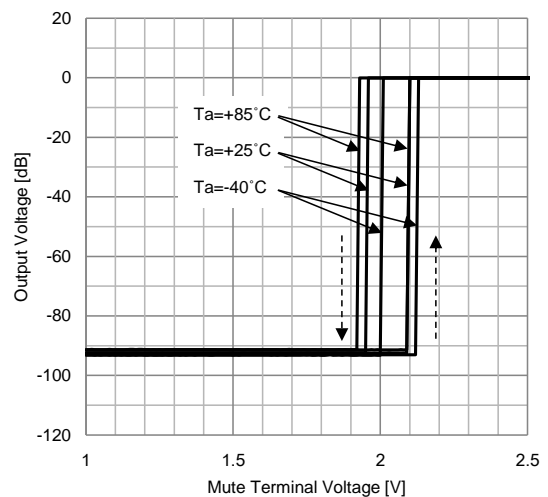

[CAUTION]
The specifications on this databook are only given for information, without any guarantee as regards either mistakes or omissions. The application circuits in this databook are described only to show representative usages of the product and not intended for the guarantee or permission of any right including the industrial rights.