

Internal 60V, 3A MOSFET Step-Up / Flyback Switching Regulator IC

■ GENERAL DESCRIPTION

NJU7678 is Step-up/Fly back type switching regulator IC with PWM control. Internal soft-start function, dead time control and timer latch function are included, requiring no external components. All parameters can be optimized by additional external components for design flexibility.

■ PACKAGE OUTLINE

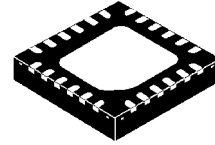

Bottom View

NJU7678MLK

■ FEATURES

- Drain to Source Voltage 60V max.
- Drain to Source Current 3A max.
- PWM switching control
- Operating Voltage Range 2.5V to 7.0V
- Oscillating Frequency Range 300kHz to 1MHz
- Maximum Duty Cycle 90% typ.
- Soft-Start Function Internal fixed value: 4ms typ.
or adjustable by external part
- Dead Time Control
- Timer Latch for Short Circuit Protection
- Package Outline NJU7678MLK: EQFN24

■ PIN CONFIGURATION

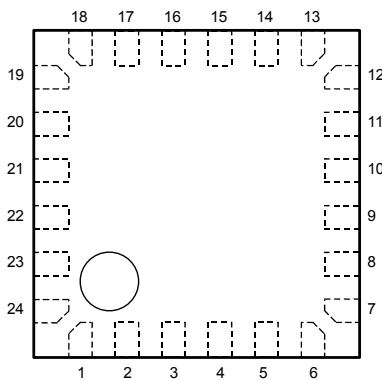

(Top View)

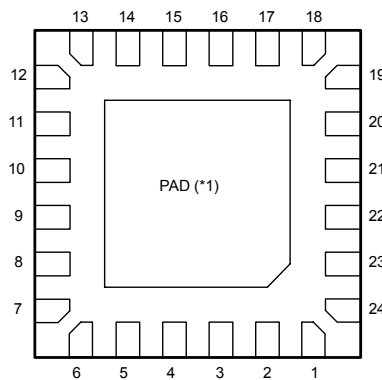

(Bottom View)

PIN FUNCTION

- | | |
|----------|--------------------|
| 1. FB | 13. N.C. |
| 2. IN- | 14. SOURCE |
| 3. N.C. | 15. SOURCE |
| 4. SCP | 16. SOURCE |
| 5. N.C. | 17. SOURCE |
| 6. DTC | 18. N.C. |
| 7. N.C. | 19. DRAIN |
| 8. RT | 20. DRAIN |
| 9. N.C. | 21. DRAIN |
| 10. GND | 22. N.C. |
| 11. N.C. | 23. V ⁺ |
| 12. N.C. | 24. N.C. |

NJU7678MLK

(*1): Exposed Pad connected to Internal FET Drain

NJU7678

■BLOCK DIAGRAM

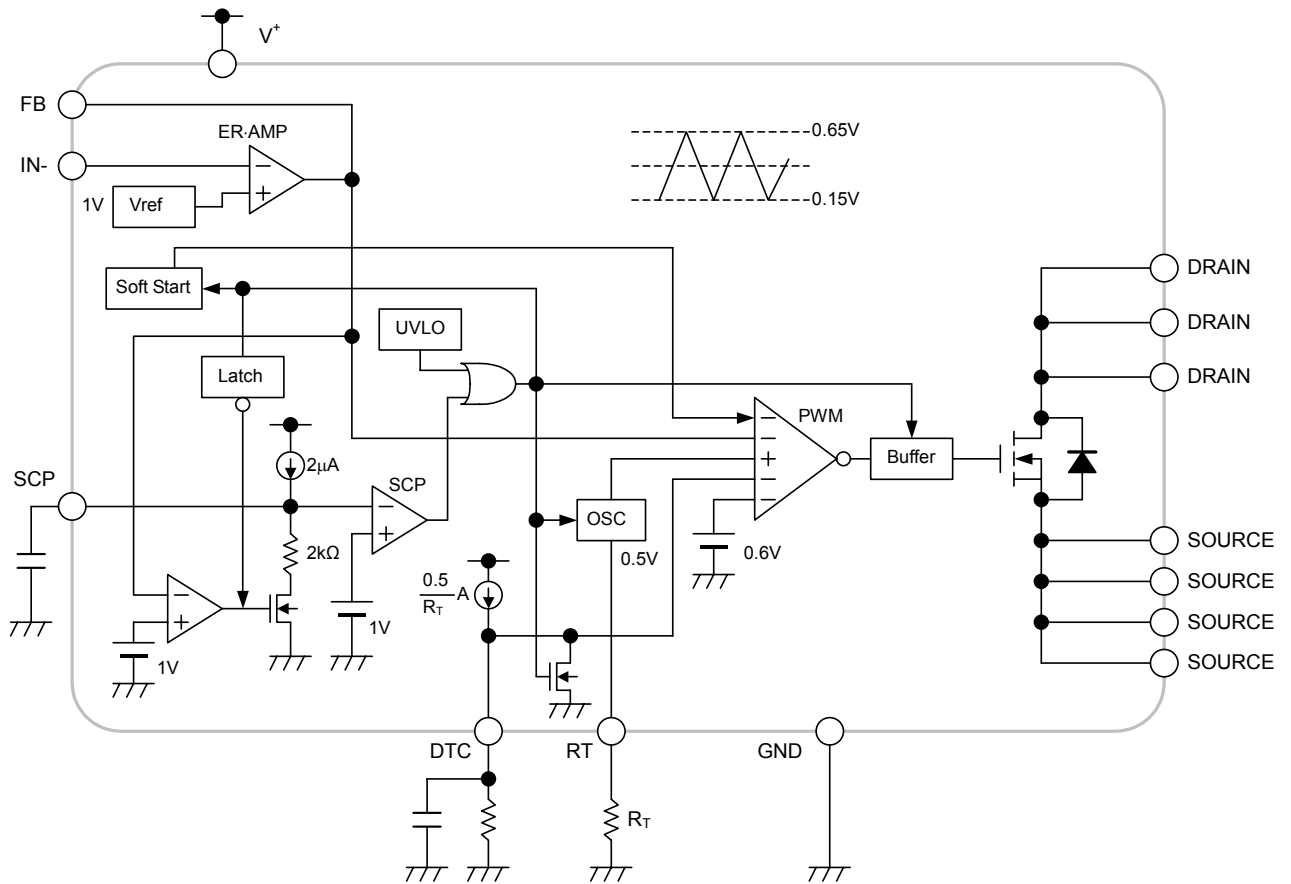

- The initial soft start time is 4msec. The soft start time can be adjusted by connecting the capacitor with the DTC pin. The charging current is calculated by $0.5/R_T$.
- The MaxDuty is 90%@700kHz. MaxDuty can be adjusted by connecting resistance with the DTC pin. MaxDuty is calculated by $(R_{DTC} / R_T) \times 86 - 24$.
- The short-circuit protection circuit is a timer latch type. The protection Delay time can be adjusted with the capacitor connected with the SCP pin. To release the latch mode, it should do reclosing the power supply (below the UVLO detection voltage) or the SCP pin down to GND level.

■ ABSOLUTE MAXIMUM RATINGS (Ta=25°C)

PARAMETER	SYMBOL	MAXIMUM RATINGS	UNIT
Supply Voltage	V ⁺	+8	V
Drain to Source Voltage	V _{DS}	66	V
Drain to Source Current	I _{DS}	3	A
Power Dissipation	P _D	660 (*2) 1,400 (*3)	mW
Operating Temperature Range	T _{OPR}	-40 ~ +85	°C
Storage Temperature Range	T _{STG}	-40 ~ +125	°C

(*2): Mounted on glass epoxy board based on EIA/JEDEC. (101.5 × 114.5 × 1.6mm: 2 Layers FR-4)

(*3): Mounted on glass epoxy board. (101.5 × 114.5 × 1.6mm: 4 Layers FR-4, copper area 99.5 × 99.5mm)

■ RECOMMENDED OPERATING CONDITIONS

PARAMETER	SYMBOL	MIN.	TYP.	MAX.	UNIT
Operating Voltage	V ⁺	2.5	—	7	V
Drain to Source Voltage	V _{DS}	—	—	60	V
Oscillator Timing Resistor	R _T	30	47	120	kΩ
Oscillation Frequency	f _{OSC}	300	700	1,000	kHz

■ PACKAGE THERMAL RESISTANCE

PARAMETER	SYMBOL	THERMAL RESISTANCE	UNIT
Junction-to-Ambient Temperature	θ _{ja}	152 (*2) 71 (*3)	°C/W
Junction-to-Case	ψ _{jt}	15.1 (*2) 9.7 (*3)	°C/W

(*2): Mounted on glass epoxy board based on EIA/JEDEC. (101.5 × 114.5 × 1.6mm: 2 Layers FR-4)

(*3): Mounted on glass epoxy board. (101.5 × 114.5 × 1.6mm: 4 Layers FR-4, copper area 99.5 × 99.5mm)

NJU7678

■ ELECTRICAL CHARACTERISTICS ($V^+=3.3V$, $R_T=47k\Omega$, $T_a=25^\circ C$)

PARAMETER	SYMBOL	TEST CONDITION	MIN.	TYP.	MAX.	UNIT
Under Voltage Lockout Block						
ON Threshold Voltage	V_{T_ON}	$V^+ = L \rightarrow H$	1.6	1.7	1.8	V
OFF Threshold Voltage	V_{T_OFF}	$V^+ = H \rightarrow L$	1.5	1.6	1.7	V
Hysteresis Voltage	V_{HYS}		60	100	–	mV
Soft Start Block						
Soft Start Time	T_{SS}	$V_{T_ON} \rightarrow \text{Duty}=80\%$	2	4	8	ms
Short Circuit Protection Block						
Input Threshold Voltage	V_{T_PC}	FB Pin	0.95	1.00	1.05	V
Charge Current	I_{CHG}	$V_{SCP}=0V$	1.5	2	2.5	μA
Latch Mode ON Threshold Voltage	V_{T_LA}	SCP Pin	0.90	1.00	1.10	V
Latch Mode OFF Threshold Voltage	V_{T_LAOFF}	SCP Pin	0.35	0.6	0.85	V
Oscillator Block						
RT Pin Voltage	V_{RT}		-8%	0.5	+8%	V
Oscillation Frequency	f_{OSC}		630	700	770	kHz
Oscillate Supply Voltage Fluctuations	f_{DV}	$V^+=2.5V$ to $7V$	–	1	–	%
Oscillate Temperature Fluctuations	f_{DT}	$T_a=-40^\circ C$ to $+85^\circ C$	–	3	–	%
Error Amplifier Block						
Reference Voltage	V_B		-1.0%	1.00	+1.0%	V
Input Bias Current	I_B		-0.1	–	0.1	μA
Open Loop Gain	A_V		–	80	–	dB
Gain Bandwidth Product	G_B		–	1	–	MHz
Output Source Current	I_{OM+}	$V_{FB}=1V$, $V_{IN-}=0.9V$	20	35	50	μA
Output Sink Current	I_{OM-}	$V_{FB}=1V$, $V_{IN-}=1.1V$	1.0	4.0	12	mA
PWM Comparator Block						
Input Threshold Voltage	V_{T_0}	Duty=0%	0.10	0.16	0.22	V
	V_{T_50}	Duty=50%	0.36	0.42	0.48	V
Maximum Duty Cycle	$M_{AX}D_{UTY_1}$	$V_{FB}=0.9V$	85	90	95	%
	$M_{AX}D_{UTY_2}$	$V_{FB}=0.9V$, $R_{DTC}=43k\Omega$	45	55	65	%
Output Block						
Drain to Source ON Resistance	$R_{DS(ON)}$	$I_O=3A$	–	0.060	0.080	Ω
	$R_{DS(ON)_2.5}$	$I_O=3A$, $V^+=2.5V$	–	0.065	0.085	Ω
Drain to Source Leak Current	I_{DS_LEAK}	$V_{DS}=60V$, $V_{IN-}=1.1V$	–	–	0.1	μA
General Characteristic						
Quiescent Current	I_{DD}	$V_{IN-}=1.1V$, $V_{FB}=0.5V$	–	6.5	7.5	mA

■ TYPICAL APPLICATIONS

< Step-up Circuit >

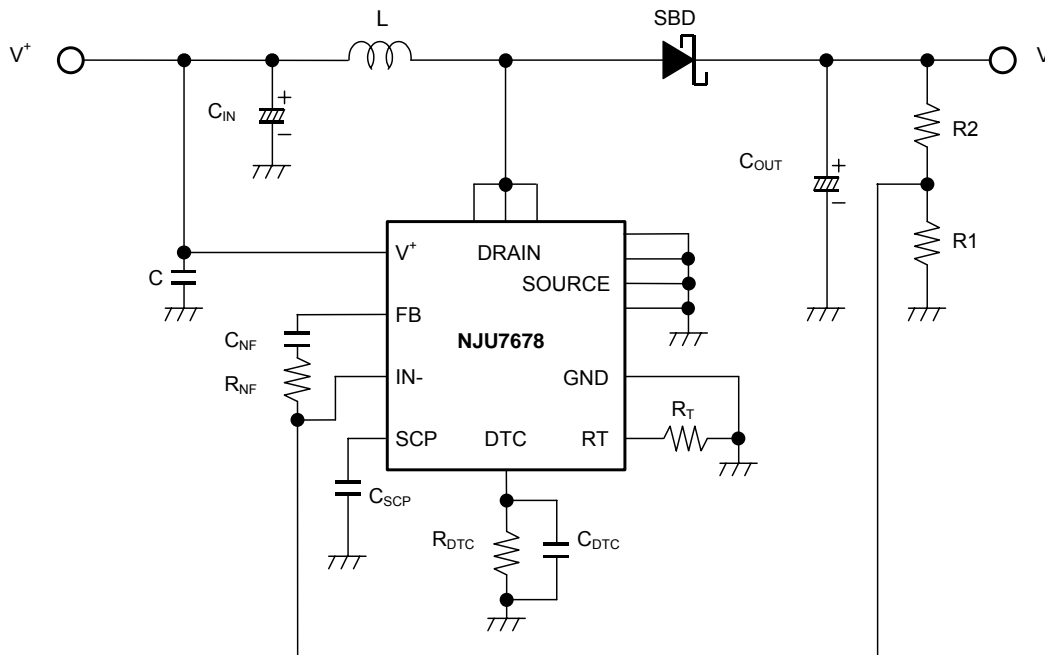

< Fly Back Circuit >

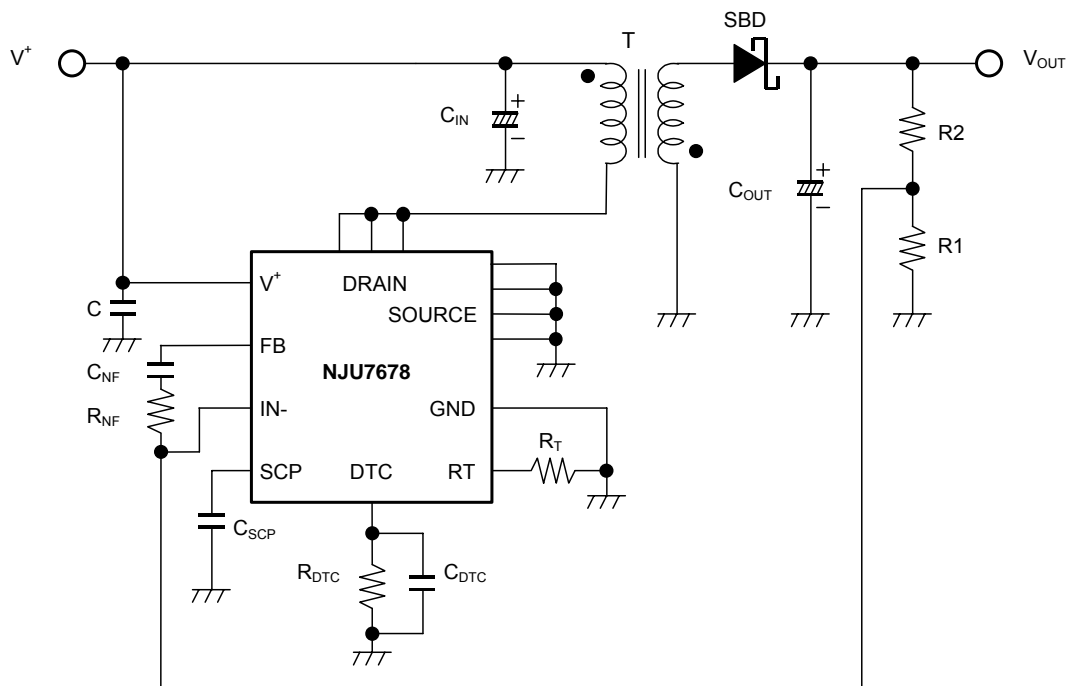

■ TYPICAL CHARACTERISTICS

Oscillation Frequency vs. Timing Resistance
($V^+ = 3.3V, T_a = 25^\circ C$)

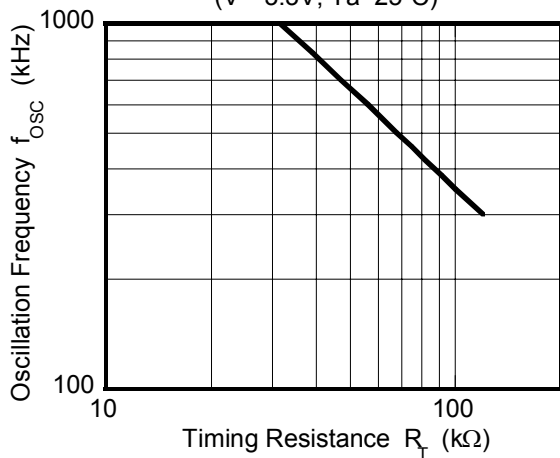

Maximum Duty Cycle vs. Oscillator Frequency
($V^+ = 3.3V, T_a = 25^\circ C$)

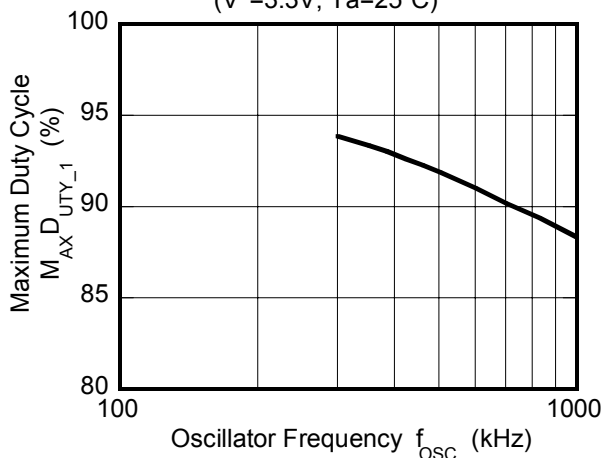

Oscillation Frequency vs. Operating Voltage
($R_T = 47k\Omega, T_a = 25^\circ C$)

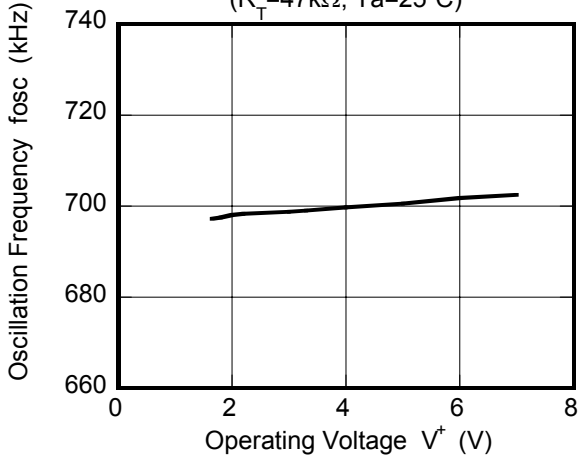

Duty Cycle vs. R_{DTC}

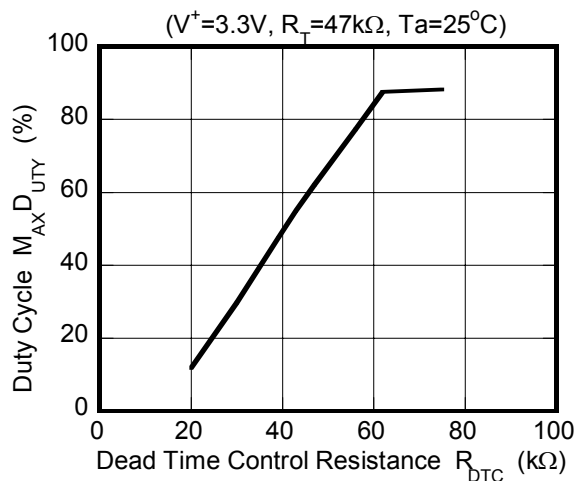

Reference Voltage vs. Operating Voltage
($T_a = 25^\circ C$)

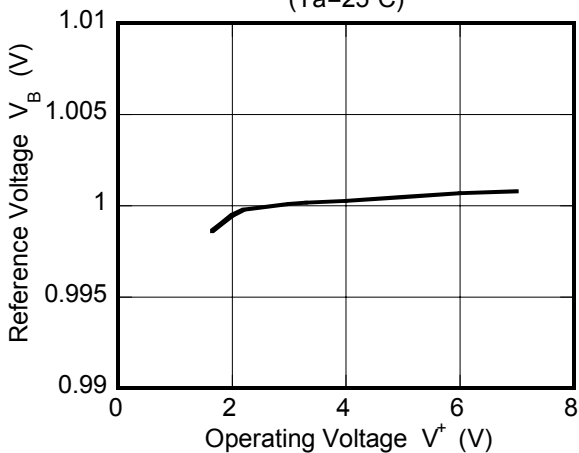

Quiescent Current vs. Operating Voltage

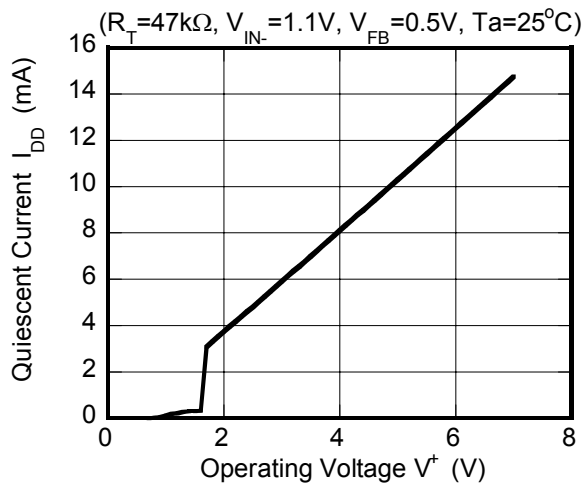

■ TYPICAL CHARACTERISTICS

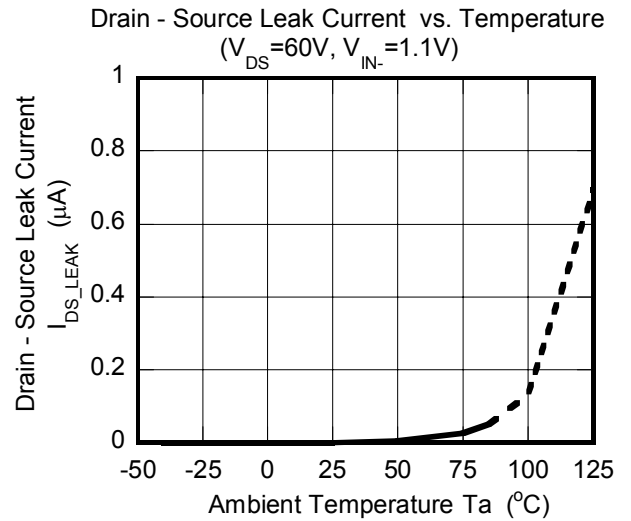
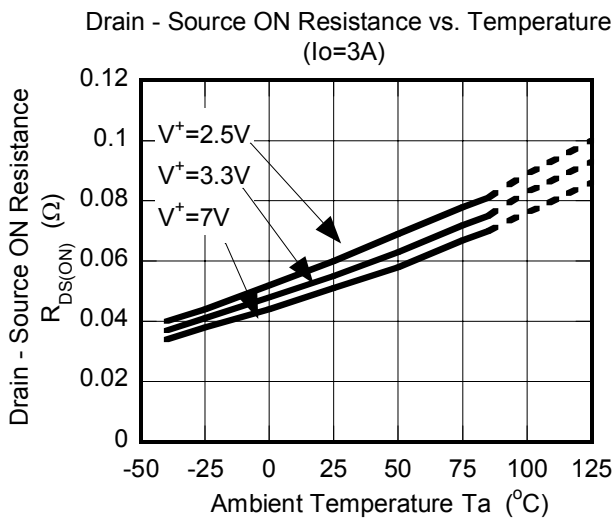
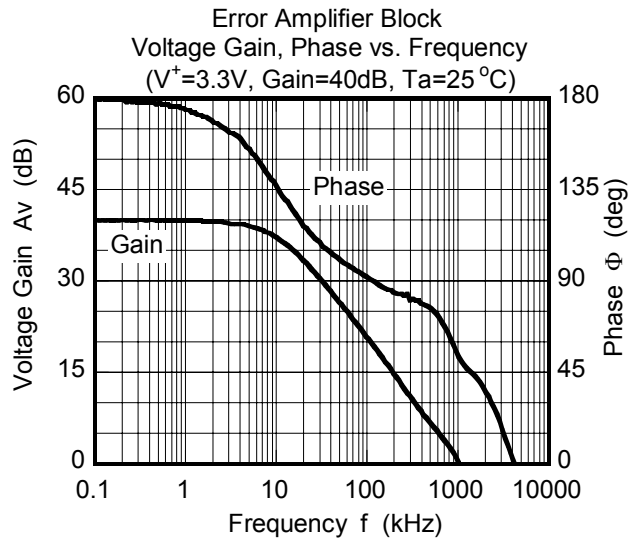

■ TYPICAL CHARACTERISTICS

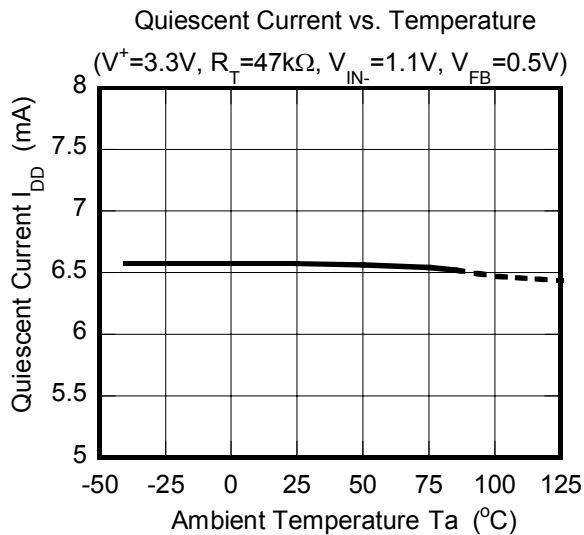
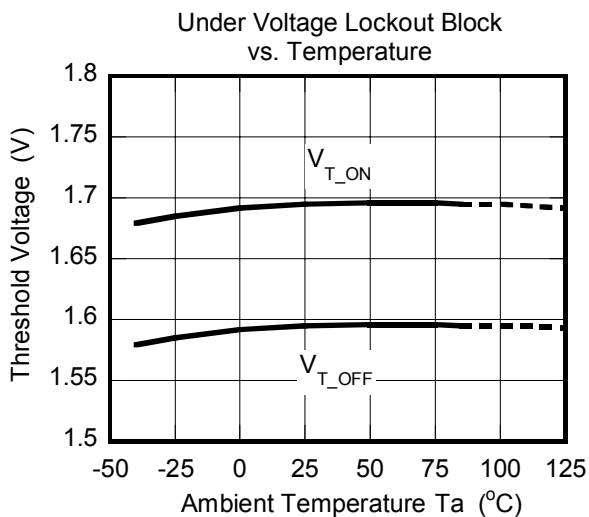
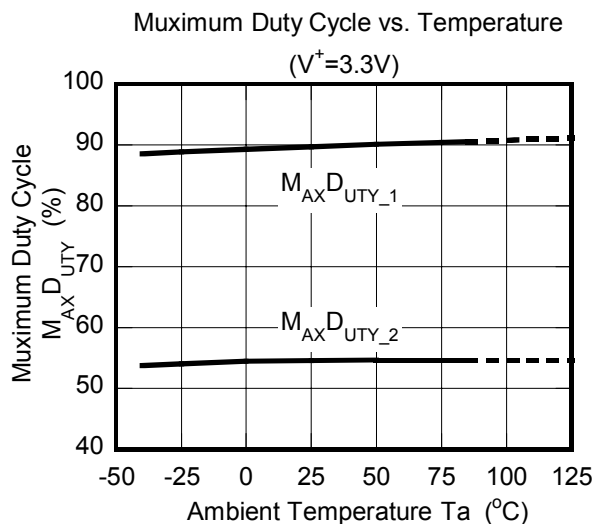
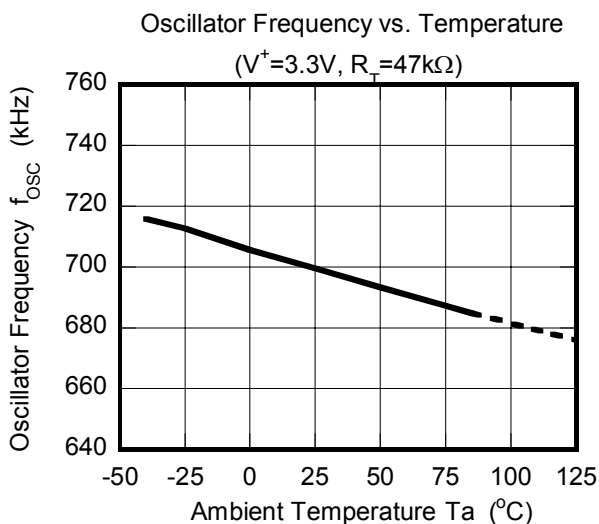
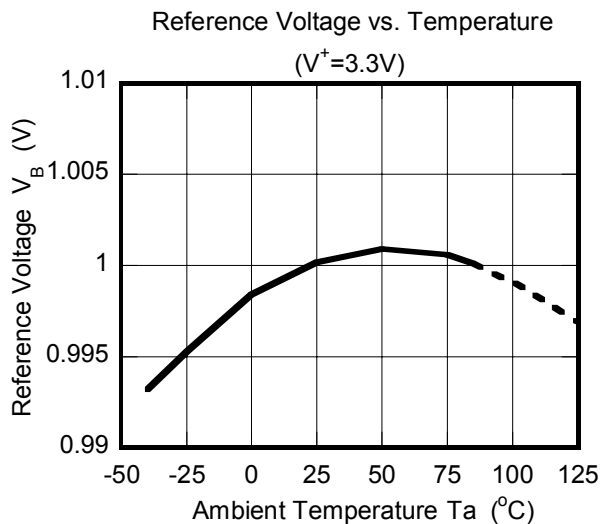
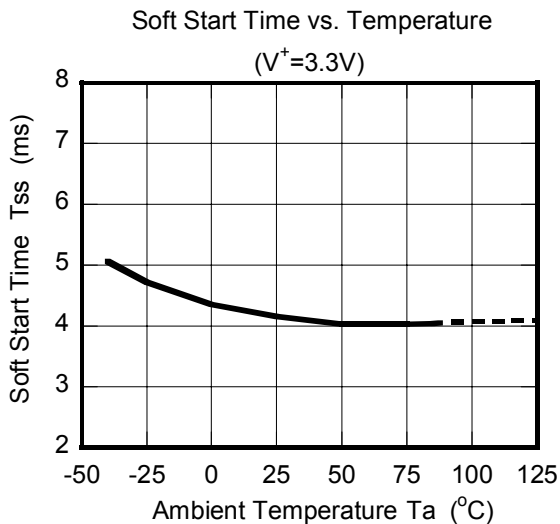

MEMO

[CAUTION]

The specifications on this databook are only given for information, without any guarantee as regards either mistakes or omissions. The application circuits in this databook are described only to show representative usages of the product and not intended for the guarantee or permission of any right including the industrial rights.