

3.1/2 DIGIT SINGLE CHIP DIGITAL MULTIMETER LSI

■ GENERAL DESCRIPTION

The NJU9212 is 3.1/2 digit single chip digital multi-meter LSI with auto-ranging function. It consists of 3.1/2 digit dual-slope A/D converter, voltage reference, controller, oscillator, battery-life detector and LCD driver.

The NJU9212 provides the optimized functions for battery operated pencil or pocket type digitized multi-meter like as low operating voltage (3V), auto-ranging, LCD display direct driving, piezo buzzer direct driving and battery life indicator.

■ PACKAGE OUTLINE

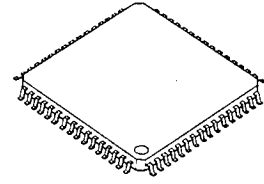

NJU9212F

■ FEATURES

- Low Operating Current
- Low Operating Voltage (3V)
- Dual-slope A/D Converter
- Auto-ranging
- LCD Display Direct Driving
- Voltage Doubler for LCD Driver On-chip
- Voltage Regulator for LCD Driving
- Piezo Buzzer Direct Driving
- Power-on Initialize
- Battery-life Detector
- Package Outline -- QFP64/Chip
- C-MOS Technology

■ PIN CONFIGURATION

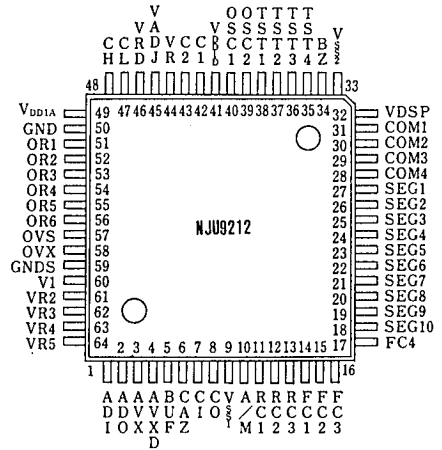

■ BLOCK DIAGRAM

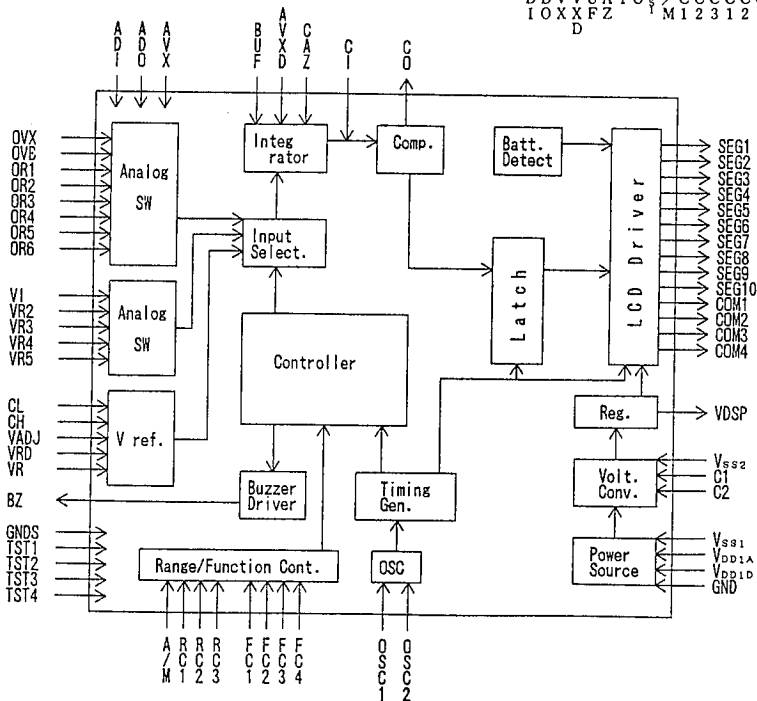

■ TERMINAL DESCRIPTION

NO.	SYMBOL	F U N C T I O N
1 2	AD1 ADO	AC → DC Conversion Input Terminal AC → DC Conversion Output Terminal
3 4	AVX AVXD	ADC "+" Input Terminal in AC Voltage Input ADC "-" Input Terminal in AC Voltage Input
5	BUF	Buffer Amplifier Output
6 7 8	CAZ CI CO	Auto-Zero Capacitor Connecting Terminal Integral Capacitor Connecting Terminal Comparator Output Terminal
10	A/M	Auto/Manual Selecting Input Terminal H Level: Auto L Level: Manual
11-13	RC1-RC3	Range Selecting Terminals (Note 1)
14-17	FC1-FC4	Function Selecting Terminals (Note 1)
18-27 28-31 32	SEG1-10 COM1-4 VDSP	LCD Segment Driver Output Terminals LCD Common Driver Output Terminals LCD Driving Voltage Monitor Terminal
34	BZ	Piezo Buzzer Driving Output Terminal
39,40	OSC2, OSC1	Quartz Crystal Connecting Terminals
42,43	C1,C2	Voltage Doubler Capacitor Connecting Terminals
44 45 46	VR VADJ VRD	Reference Voltage Output Terminal Reference Voltage Adjustment Terminal Reference Voltage Monitor Terminal
47,48	CL,CH	Reference Capacitor Connecting Terminals
51-56 57 58	OR1-6 OVS OVX	Reference Resistor Connecting Terminals for Resistance Measurement Reference Voltage Input Terminal for Resistance Measurement Measuring Voltage Input Terminal for Resistance Measurement
60	VI	Voltage Measurement Input Terminal
61-64	VR2-VR5	Bleeder Resistor Connecting Terminals
35-38	TST1-TST4	Test Terminals 1~4 (Normally Open)
9 33 41 49 50 59	V _{SS1} V _{SS2} V _{DD1D} V _{DD1A} GND GNDS	Analog, Digital GND Terminal 0V LCD Driving Voltage Supply Terminal -3V Digital Block Voltage Supply Terminal +3V Analog Block Voltage Supply Terminal +3V Analog Block Center point Voltage Supply Terminal +1.5V GND Sensing Terminal in Integral Operation

5

(Note 1) With Pull-Up resistance except the A/M terminal.

FUNCTIONAL DESCRIPTION
(1) MEASUREMENT FUNCTION

Measurement Function	Range	Auto or Manual
DC Voltage	200mV~400V 5-Range	Auto/Manual Range
AC Voltage	2V ~ 400V 4-Range	Auto/Manual Range
Resistance	100Ω~20MΩ 6-Range	Auto/Manual Range
Diode Check		
Continuity Check		

(2) MEASUREMENT FUNCTION SELECTION (By the FC1 ~ FC4 terminals input)

FUNCTION	FC1	FC2	FC3	FC4
DCV	H	H	H	H
ACV	L	H	H	H
Ω	H	H	L	H
▶	H	L	L	H
CONTI	H	H	H	L

(3) MEASUREMENT FUNCTION SELECTION SWITCH

The mechanical lock type or rotary type switch is required.

(4) THE KEY INPUT CONFIRMATION SOUND OF SWITCH OPERATION / SYSTEM RESET

Piezo buzzer driving signal for the key input confirmation sound and the system reset signal are output, when the switch is operated.

a) THE KEY INPUT CONFIRMATION SOUND SIGNAL(2kHz)

2kHz clock is output from BZ terminal about 31.25mS period at the rising or falling edge of input signals to the FC1 ~ FC4 terminals. This signal can drive a Piezo Buzzer directly.

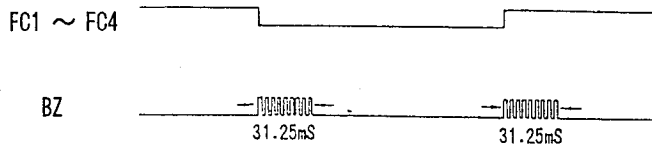

b) SYSTEM RESET SIGNAL

The range-set, counter-reset and auto-reset are performed synchronizing the rising or falling edge of input signals to the FC1 ~ FC4 terminals.

[Range-Set]

When the function was changed in the auto-range mode, the range is set as follows:

FUNCTION	RANGE	POINT
DCV	200mV	P1
ACV	2 V	P3
Ω	200 Ω	P1
	2 V	P3
CONT I	2k Ω	P3

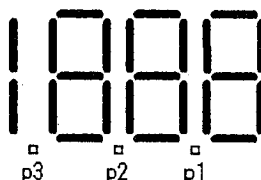
5
[COUNTER RESET]

When the function is changed even if the A/D conversion period, the counter reset signal is output internally and the LSI is initialized. Afterward, the A/D conversion is start from auto-zero cycle.

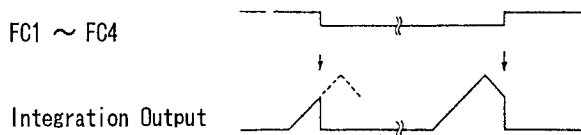
(5) CONTINUITY CHECK FUNCTION

When select continuity check function, 200 Ω range of Ω function is set automatically. If the measured value is less than 190 Ω , the buzzer sound is output continuously and the measured resistor value is displayed.

(6) DIODE CHECK FUNCTION

When select diode check function, 2k Ω range of k Ω function is set automatically and measured a diode forward voltage by supplied 1.5V. If the input terminals are open, the voltage corresponding to the battery voltage is displayed.

(7) FULL AUTO-RANGE FUNCTION (A/M=H Level)

① The following flow is performed by range control terminal (RC1):

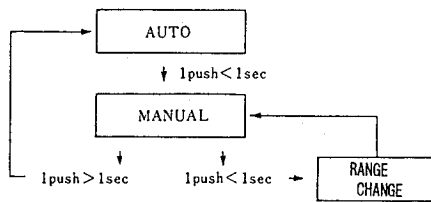

Apply the Momentary-type switch for the range control.

FUNCTION	A U T O		M A N U A L		RANGE CONTROL
		1 PUSH	1 PUSH (<1sec.)		
D C V	RNG1 ~ RNG5	→ HOLD	RNG _i → RNG _{i+1} (RNG5 → RNG1)		200mV ~ 400V
A C V	RNG1 ~ RNG4	→ HOLD	RNG _i → RNG _{i+1} (RNG4 → RNG1)		2V ~ 400V
Ω	RNG1 ~ RNG6	→ HOLD	RNG _i → RNG _{i+1} (RNG6 → RNG1)		200Ω ~ 20MΩ

② AUTO-RETURN FUNCTION

When the range selecting terminal is kept L level over than 1 sec or a function is changed by FC1~FC4 terminals, the range can be changed a function to auto range from any fixed range.

③ THE RANGE SELECTING CONFIRMATION SIGNAL

2kHz clock is output on BZ terminal about 31.25mS period at the falling edge of the RC1 terminal input. This signal can drive a Piezo Buzzer directly.

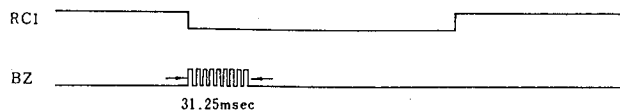

(8) MANUAL RANGE FUNCTION (A/M=L Level)

① Manual range is selected by RC1~RC3 as follows:

RC1	RC2	RC3	DCV	ACV	DCI, ACI	Ω
H	H	H	RNG2, 2V	RNG1, 2V	RNG1, 2mA	RNG2, 2K Ω
L	H	H	RNG3, 20V	RNG2, 20V	RNG2, 20mA	RNG3, 20K Ω
H	L	H	RNG4, 200V	RNG3, 200V	RNG3, 200mA	RNG4, 200K Ω
L	L	H	RNG5, 400V	RNG4, 400V	RNG4, 2000mA	RNG5, 2000K Ω
H	H	L	RNG5, 400V	RNG4, 400V	RNG5, 20A	RNG6, 20M Ω
L	H	L	RNG1, 200mV	RNG1, 2V	RNG1, 2mA	RNG1, 200 Ω

② MODE CHANGE OPERATION CONFIRMATION SOUND SIGNAL(2kHz)

2kHz clock is output on BZ terminal about 31.25mS period at the rising or falling edge of RC1 ~ FC3 terminals input. This signal can drive a Piezo Buzzer directly.

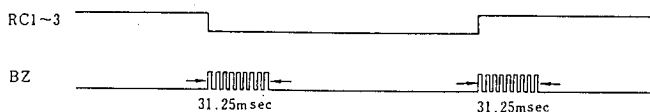

(9) CHATTER-FREE FUNCTION

All input terminals for control are build with the chatter-free circuits which eliminate chattering input less than 62.5mS

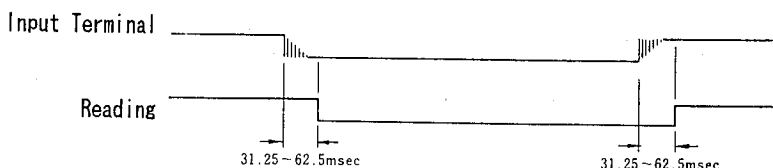

(10) BUZZER DRIVING SIGNAL

Adding to the switch operation confirmation signal output by FC1 ~ FC4 and RC1 ~ RC3, the buzzer driving signals is also output at the following conditions.

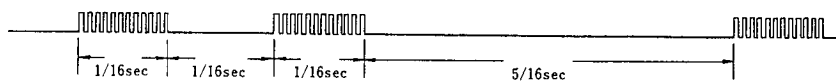
 ① Alarm sound for over range (except Ω)

② Confirmation for continuity



(11) LCD DISPLAY FUNCTION

- LCD Display pattern

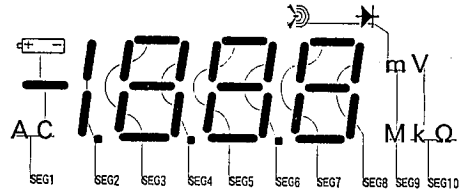
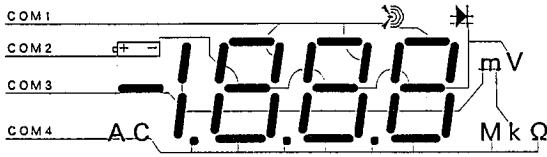



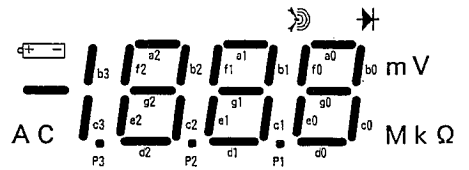



5



- Segment Assignment

	SEG1	SEG2	SEG3	SEG4	SEG5	SEG6	SEG7	SEG8	SEG9	SEG10
COM 1			a2	b2	a1	b1	a0	b0	>·)))	
COM 2	BATT		f2	g2	f1	g1	f0	g0	→+	V
COM 3	-	b3/c3	e2	c2	e1	c1	e0	c0	m	K
COM 4	AC	p3	d2	p2	d1	p1	d0		M	Ω

• Display Mark Explanation

- ① [BATT MARK] ()
[] is displayed when either the V_{DD} or V_{SS} becomes lower than 1.1V~1.3V.
- ② [-]
[-] is displayed when the DCV input is "-".
- ③ [AC]
[AC] is displayed when the ACV mode is selected.
- ④ []
[] is displayed when the continuity check function is selected.
- ⑤ []
[] is displayed when the diode check function is selected.
- ⑥ [mV]
[mV] is displayed when 200mV range of DCV is selected.
- ⑦ [V]
[V] is displayed when 2V, 20V, 200V and 400V range of DCV and ACV is selected.
- ⑧ [Ω]
[Ω] is displayed when the 200Ω range and continuity function is selected.
- ⑨ [kΩ]
[kΩ] is displayed when 2kΩ, 20kΩ, 200kΩ and 2000kΩ range is selected.
- ⑩ [MΩ]
[MΩ] is displayed when the 20MΩ range is selected.

(12) Power-On Initialization

When turn on the power, the power-on-initialization circuits performs

- All LCD Display ON
- Piezo buzzer driving signal output (about 62.5mS)
- Initializing the internal circuits.

■ ABSOLUTE MAXIMUM RATINGS

(Ta=25°C)

PARAMETER		SYMBOL	RATINGS	UNIT
Supply Voltage		$V_{DD1}-V_{SS1}$	4.0	V
		GND $-V_{SS1}$	2.0	
Control Terminal Input Voltage		V_{ID}	$V_{DD1} \sim V_{SS1}$	V
Analog Terminal Input Voltage		V_{IA}	$V_{DD1} \sim V_{SS1}$	V
Soldering Temperature		T_{SOL}	260	°C
Soldering Time		t_{SOL}	10	sec
Operating Temperature Range		T_{opr}	0 ~ + 50	°C
Storage Temperature Range		T_{stg}	- 40 ~ +125	°C
Input Current	Power Supply Term.	I_{DD}, I_{GND}, I_{SS}	± 50	mA
	ORI Terminal	I_{ORI}	± 50	
	Oth. Terminals	I_I, I_O	± 10	

5

■ ELECTRICAL CHARACTERISTICS

 (Ta=25°C, $V_{DD1}=3.0V$, GND=1.5V, DC 200mV Range)

PARAMETER	SYMBOL	CONDITIONS		MIN	TYP	MAX	UNIT
Operating Voltage	V_{DD1}	* 1		1.8	3.0	3.6	V
	GND			0.9	1.5	1.8	
Operating Current	I_{DD}					1.0	mA
Sampling Time	T_s				100		ms
Sampling Rate	N_r				2		Times/ sec
Linearity	L_{in}	R1=10MΩ R1=series input resistor				±0.2	%F.S
Rollover Error	E_p					±0.1	
Zero Input Reading	Zero			0	0	0	
Step Up Voltage	V_{SS2}	V_{SS2} Terminal			- 2.8		V
Input Voltage	V_{IH}	FC1~FC4, RC1~RC4,		2.45			V
	V_{IL}	A/M Terminals				0.55	V
Input Pull-up Resistance	R_I	FC1~FC4, RC1~RC4 Terminals		100	300	500	kΩ
Buzzer Driving Current	I_{OH}	BZ Terminal	$V_{OH}=2.7V$	0.25	0.75		mA
	I_{OL}		$V_{OL}=0.3V$	0.25	0.75		mA
Open-circuit Voltage for OHM Measurements	V_{Ω}	200Ω~20MΩ			0.43		V
Output Voltage	V_H	COM1~COM4			-1.03		V
	V_L	SEG1~SEG10			-2.07		
	V_{DSP}	(LCD driving waveform)			-3.10		
Input Leakage Current	I_{IL}	VI Terminal	$V_{in}=0mV$			± 10	pA
			$V_{in}=\pm 200mV$			±100	pA

 * 1) V_{DD1A} and V_{DD1D} are same voltage, so V_{DD1} is a generic term.

■ LCD Driving Waveform
(1/4duty, DC200mV Range, $V_{in}=0mV$)

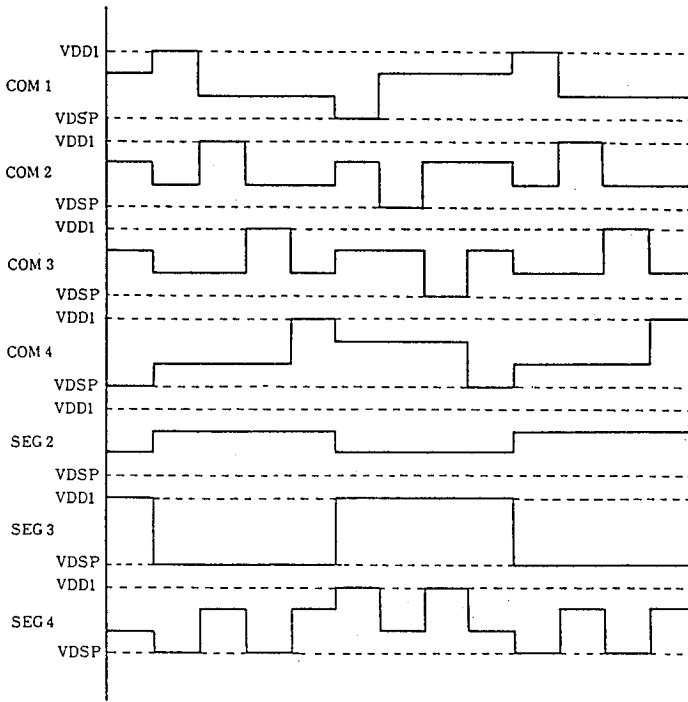

■ APPLICATION CIRCUIT (Auto-Range DMM)

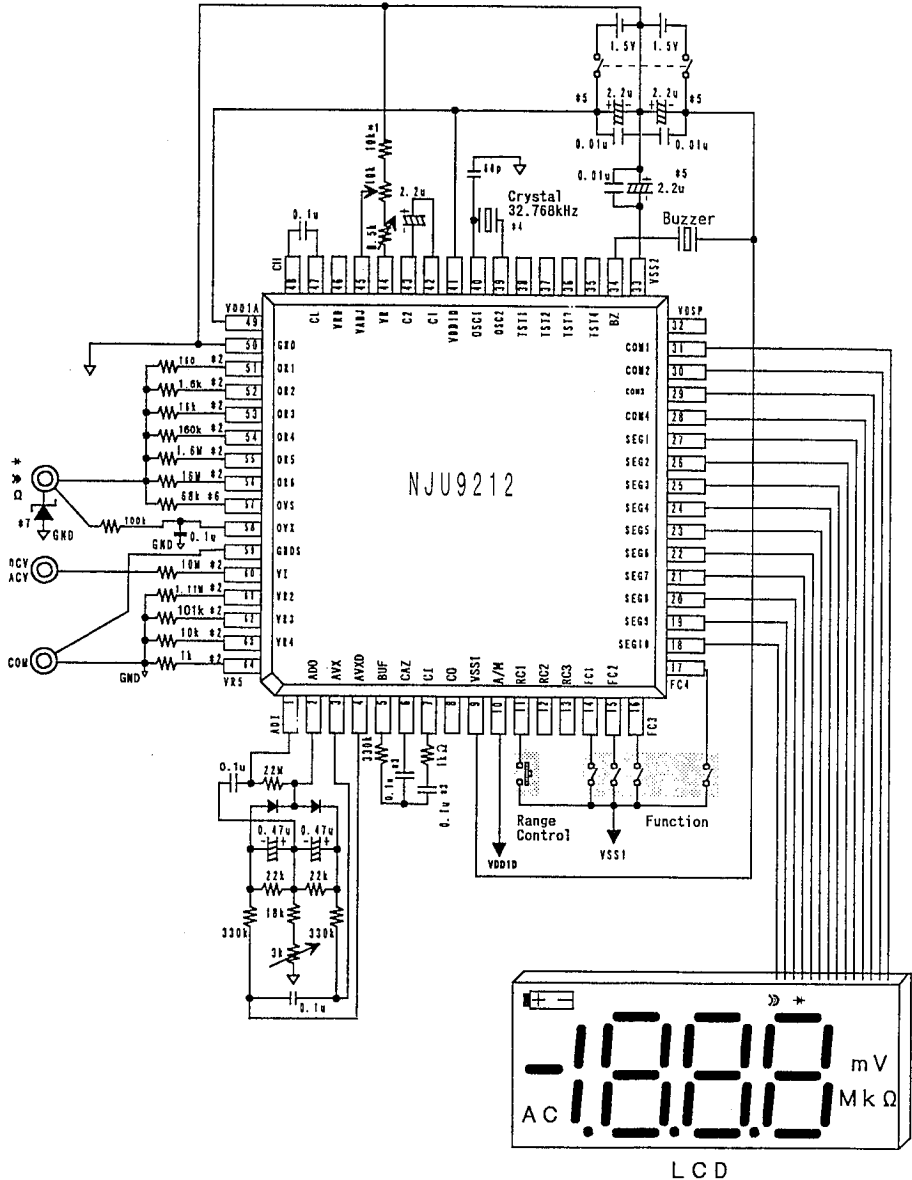

- *1 : Accuracy : less than $\pm 0.2\%$
The relative error of temperature characteristics : less than $\pm 50\text{ppm}$.
- *2 : Accuracy : less than $\pm 0.5\%$
No mentioned resistor : less than $\pm 1.0\%$
- *3 : Polypropylene film capacitor
- *4 : Quartz Crystal : 32.768kHz, $C1 \leq 30\text{k}\Omega$
- *5 : Decoupling Capacitor should be connected between V_{DD} and GND, V_{SS1} and GND, V_{SS2} and GND.
- *6 : Diode-check-function, if you demand to indicate at accuracy when input-terminal is released ,replace resistance of $68\text{k}\Omega$ with variable-resistance and regulate it.
- *7 : Surely, connect Zenner-diode for input protection.
- *8 : If you demand to high level accuracy, regulate resistance for attenuator.

MEMO

[CAUTION]

The specifications on this databook are only given for information, without any guarantee as regards either mistakes or omissions. The application circuits in this databook are described only to show representative usages of the product and not intended for the guarantee or permission of any right including the industrial rights.