

## AUDIO PROCESSOR

### ■ GENERAL DESCRIPTION

The NJW1141 is a sound processor includes all of the functions required to process the audio signal for TV, such as tone control, balance, volume, mute, and AGC functions.

All of the internal status and variables are controlled by I<sup>2</sup>C BUS interface.

### ■ PACKAGE OUTLINE

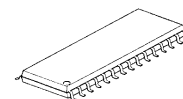
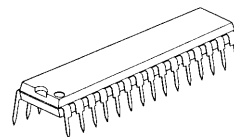

### ■ FEATURES

- Operating Voltage 8 to 10V
- I<sup>2</sup>C BUS Interface
- Internal 4 Input Audio Selectors and Monitor Output
- Low Noise VCA
- Variable AGC Compression Level via I<sup>2</sup>C (4-levels)
- Bi-CMOS Technology
- Package Outline SDIP30, SDMP30

NJW1141L

NJW1141M

### ■ BLOCK DIAGRAM

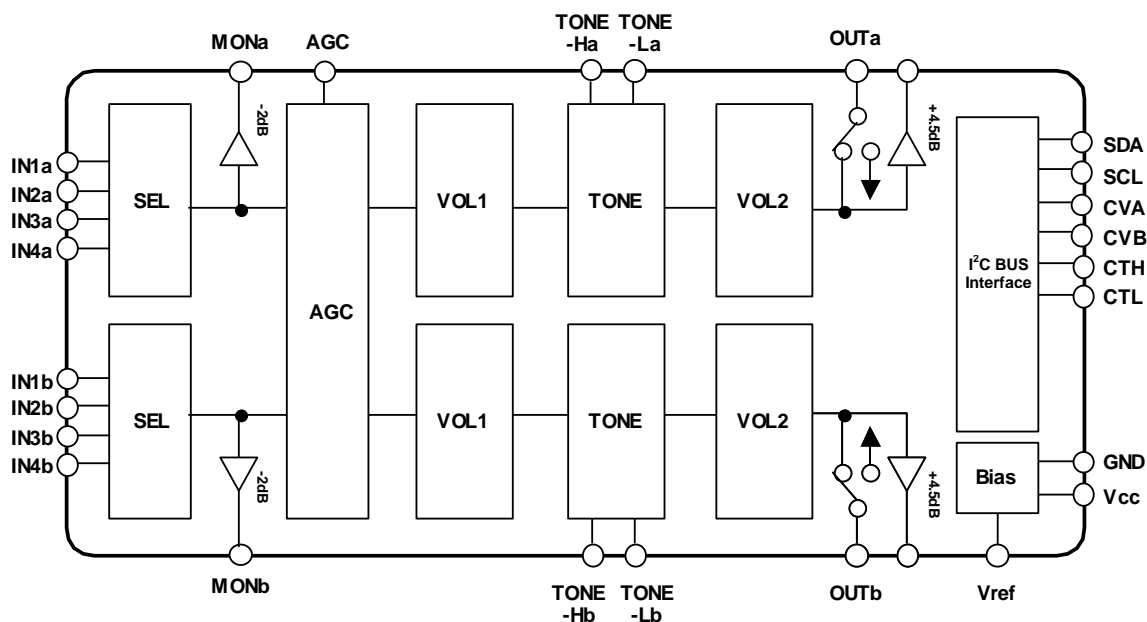

# NJW1141

## ■ PIN CONFIGURATION

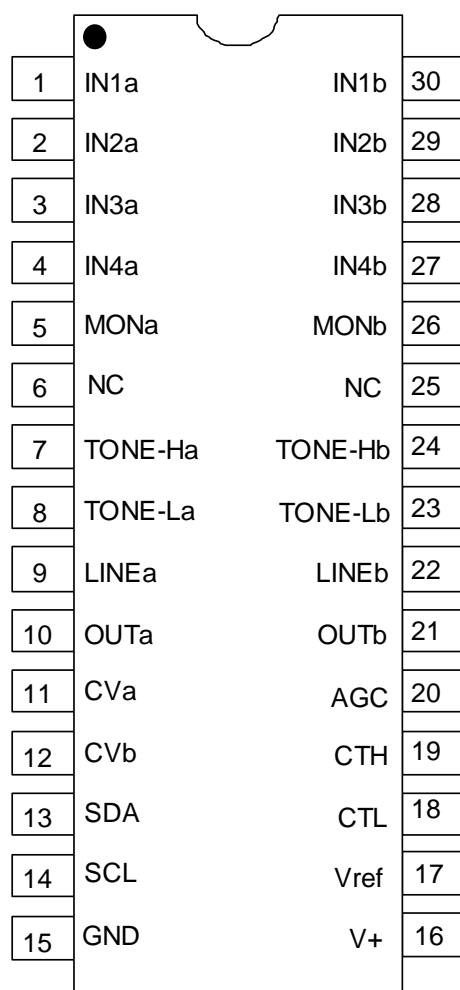

No.	Symbol	Function	Symbol	Function	
1	IN1a	Ach Input1	16	V+	Power Supply Terminal
2	IN2a	Ach Input2	17	Vref	Reference Voltage
3	IN3a	Ach Input3	18	CTL	Pop Noise reduction for Bass Control
4	IN4a	Ach Input4	19	CTH	Pop Noise reduction for Treble Control
5	MONa	Ach Monitor Output	20	AGC	AGC Filter
6	NC	No Connect	21	OUTb	Bch Output
7	TONE-Ha	Ach Treble Filter	22	LINEb	Bch LINE Output (+4.5dB)
8	TONE-La	Ach Bass Filter	23	TONE-Lb	Bch Bass Filter
9	LINEa	Ach LINE Output (+4.5dB)	24	TONE-Hb	Bch Treble Filter
10	OUTa	Ach Output	25	NC	No Connect
11	CVB	DAC Output for Bch Volume & Balance	26	MONb	Bch Monitor Output
12	CVA	DAC Output for Ach Volume & Balance	27	IN4b	Bch Input4
13	SDA	SDA Data Input (I <sup>2</sup> C BUS)	28	IN3b	Bch Input3
14	SCL	SCL Clock Input (I <sup>2</sup> C BUS)	29	IN2b	Bch Input2
15	GND	GND Terminal	30	IN1b	Bch Input1

### ■ ABSOLUTE MAXIMUM RATING (Ta=25°C)

PARAMETER	SYMBOL	RATING	UNIT
Supply Voltage	V <sup>+</sup>	12	V
Power Dissipation	P <sub>D</sub>	700	mW
Operating Temperature Range	T <sub>opr</sub>	-20 to +75	°C
Storage Temperature Range	T <sub>stg</sub>	-40 to +125	°C

### ■ ELECTRICAL CHARACTERISTICS ( Ta=25°C, V<sup>+</sup>=9V, R<sub>g</sub>=600Ω, R<sub>L</sub>=47kΩ, Vin=100mVrms/1kHz)

PARAMETER	SYMBOL	TEST CONDITION	MIN.	TYP.	MAX.	UNIT
Operating Voltage	V <sup>+</sup>		8.0	9.0	10.0	V
Supply Current	I <sub>CC</sub>	No Signal	-	8.0	25.0	mA
Reference Voltage	V <sub>REF</sub>	No Signal	4.0	4.5	5.0	V
Maximum Input Voltage	V <sub>IM</sub>	VOL=-20dB, THD=3%	2.8	3.0	-	Vrms
Maximum Output Voltage1	V <sub>OM1</sub>	OUTPUT VOL=0dB, THD=1%	-	2.5	-	Vrms
Maximum Output Voltage2	V <sub>OM2</sub>	LINEOUT VOL=0dB, THD=1%	-	2.5	-	Vrms
MON OUT Gain	G <sub>VMON</sub>	MON OUT	-	-2.0	-	dB
LINEOUT Gain	G <sub>VLINE</sub>	LINEOUT, VOL=0dB	2.5	4.5	6.5	dB
Maximum Gain	G <sub>VMAX</sub>	VOL=0dB	-2.0	0.0	2.0	dB
Minimum Gain	G <sub>VMIN</sub>	VOL=Mute, Vin=1Vrms BW=400Hz to 30kHz	-	-	-70	dB
Channel Balance	G <sub>CB</sub>	VOL=0dB	-1.5	0.0	1.5	dB
Balance Boost A	BA <sub>BST</sub>	CHS="0",BAL="11111"	-2.0	0.0	2.0	dB
Balance Cut A	BA <sub>CUT</sub>	CHS="1",BAL="11111" Vin = 1Vrms BW=400Hz to 30kHz	-	-	-70	dB
Balance Boost B	BB <sub>BST</sub>	CHS="1",BAL="11111"	-2.0	0.0	2.0	dB
Balance Cut B	BB <sub>CUT</sub>	CHS="0",BAL="11111" Vin = 1Vrms BW=400Hz to 30kHz	-	-	-70	dB
Total Harmonic Distortion	THD	Vo=0.5Vrms BW=400Hz to 30kHz	-	-	0.5	%
Input Selector Cross Talk	CT	Vin=1Vrms BW=400Hz to 30kHz	-	-	-70	dB
Channel Separation	CS	Vin=1Vrms BW=400Hz to 30kHz	-	-	-70	dB
Output Noise 1	V <sub>NO1</sub>	VOL=0dB BW=400Hz to 30kHz	-	-90 (31.6)	-85 (56.2)	dBV (μVrms)
Output Noise 2	V <sub>NO2</sub>	VOL=Mute BW=400Hz to 30kHz	-	-106 (5.0)	-96 (15.8)	dBV (μVrms)
Output Noise 3	V <sub>NO3</sub>	LINEOUT, VOL=0dB BW=400Hz to 30kHz	-	-85 (56.2)	-80 (100)	dBV (μVrms)
Output Noise 4	V <sub>NO4</sub>	LINEOUT, VOL=Mute BW=400Hz to 30kHz	-	-101 (8.9)	-91 (28.2)	dBV (μVrms)

# NJW1141

## ■ ELECTRICAL CHARACTERISTICS ( Ta=25°C, V<sup>+</sup>=9V, R<sub>g</sub>=600Ω, R<sub>L</sub>=47kΩ, V<sub>in</sub>=100mVrms/1kHz)

### ● TONE CONTROL (Tone Control-ON)

PARAMETER	SYMBOL	TEST CONDITION	MIN.	TYP.	MAX.	UNIT
High Frequency Boost	HF <sub>BST</sub>	TREBLE=+15dB, f=10kHz	12.5	15.0	17.5	dB
High Frequency Flat	HF <sub>FLT</sub>	TRBE=0dB, f=10kHz	-2.0	0.0	2.0	dB
High Frequency Cut	HF <sub>CUT</sub>	TREBLE=-15dB, f=10kHz	-17.5	-15.0	-12.5	dB
Low Frequency Boost	LF <sub>BST</sub>	BASS=+15dB, f=100Hz	12.5	15.0	17.5	dB
Low Frequency Flat	LF <sub>FLT</sub>	BASS=0dB, f=100Hz	-2.0	0.0	2.0	dB
Low Frequency Cut	LF <sub>CUT</sub>	BASS=-15dB, f=100Hz	-17.5	-15.0	-12.5	dB

### ● SUB-TONE CONTROL (Sub-Tone Control-ON)

PARAMETER	SYMBOL	TEST CONDITION	MIN.	TYP.	MAX.	UNIT
High Frequency Boost	SHF <sub>BST</sub>	SUB-TREBLE=+3dB, f=10kHz	2.0	3.0	4.0	dB
High Frequency Flat	SHF <sub>FLT</sub>	SUB-TREBLE=0dB, f=10kHz	-2.0	0.0	2.0	dB
High Frequency Cut	SHF <sub>CUT</sub>	SUB-TREBLE=-3dB, f=10kHz	-4.0	-3.0	-2.0	dB
Low Frequency Boost	SLF <sub>BST</sub>	SUB-BASS=+3dB, f=100Hz	2.0	3.0	4.0	dB
Low Frequency Flat	SLF <sub>FLT</sub>	SUB-BASS=0dB, f=100Hz	-2.0	0.0	2.0	dB
Low Frequency Cut	SLF <sub>CUT</sub>	SUB-BASS=-3dB, f=100Hz	-4.0	-3.0	-2.0	dB

### ● AGC (AGC-ON)

PARAMETER	SYMBOL	TEST CONDITION	MIN.	TYP.	MAX.	UNIT
AGC BOOST	AGC <sub>BST</sub>	V <sub>in</sub> =50mVrms	1.5	3.5	5.5	dB
AGC FLAT 1	AGC <sub>FLT1</sub>	V <sub>in</sub> =300mVrms	-2.5	0.0	2.5	dB
AGC FLAT 2	AGC <sub>FLT2</sub>	V <sub>in</sub> =400mVrms	-2.5	0.0	2.5	dB
AGC FLAT 3	AGC <sub>FLT3</sub>	V <sub>in</sub> =500mVrms	-2.5	0.0	2.5	dB
AGC FLAT 4	AGC <sub>FLT4</sub>	V <sub>in</sub> =600mVrms	-2.5	0.0	2.5	dB
AGC CUT	AGC <sub>CUT</sub>	V <sub>in</sub> =2Vrms	-14	-10	-6.0	dB

### ■ I<sup>2</sup>C BUS BLOCK CHARACTERISTICS (SDA,SCL)

PARAMETER	SYMBOL	MIN.	TYP.	MAX.	UNIT
High Level Input Voltage	V <sub>IH</sub>	3.0	-	5.0	V
Low Level Input Voltage	V <sub>IL</sub>	0	-	1.5	V
High Level Input Current	I <sub>IH</sub>	-	-	10	μA
Low Level Input Current	I <sub>IL</sub>	-	-	10	μA
Low Level Output Voltage (3mA at SDA pin)	V <sub>OL</sub>	0	-	0.4	V
Maximum Output Current	I <sub>OL</sub>	-3.0	-	-	mA
Maximum Clock Frequency	f <sub>SCL</sub>	-	-	100	kHz
Data Change Minimum Waiting Time	t <sub>BUF</sub>	4.7	-	-	μs
Data Transfer Start Minimum Waiting Time	t <sub>HD:STA</sub>	4.0	-	-	μs
Low Level Clock Pulse Width	t <sub>LOW</sub>	4.7	-	-	μs
High Level Clock Pulse Width	t <sub>HIGH</sub>	4.0	-	-	μs
Minimum Start Preparation Waiting Time	t <sub>SU:STA</sub>	4.7	-	-	μs
Minimum Data Hold Time	t <sub>HD:DAT</sub>	0	-	3.45	μs
Minimum Data Preparation Time	t <sub>SU:DAT</sub>	250	-	-	ns
Rise Time	t <sub>R</sub>	-	-	1.0	μs
Fall Time	t <sub>F</sub>	-	-	300	ns
Minimum Stop Preparation Waiting Time	t <sub>SU:STO</sub>	4.0	-	-	μs

I<sup>2</sup>C BUS Load Condition: Pull up resistance 4kΩ (Connected to +5V)  
Load capacitance 200pF (Connected to GND)

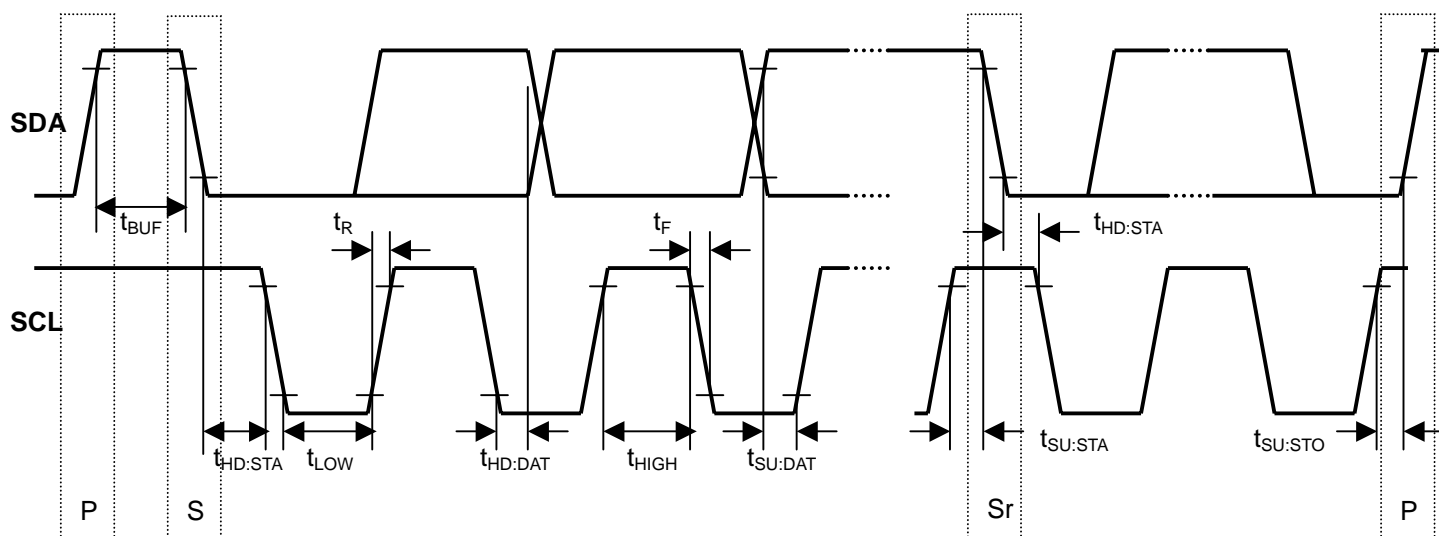

# NJW1141

## ■ TERMINAL DESCRIPTION

No.	SYMBOL	FUNCTION	EQUIVALENT CIRCUIT	VOLTAGE
1 2 3 4 27 28 29 30	IN1a IN2a IN3a IN4a IN4b IN3b IN2b IN1b	Ach Input 1 Ach Input 2 Ach Input 3 Ach Input 4 Bch Input 4 Bch Input 3 Bch Input 2 Bch Input 1		V+/2
5 9 10 21 22 26	MONa LINEa OUTa OUTb LINEb MONb	Ach Monitor Output (-2dB) Ach LINE Output (4.5dB) Ach Output (0dB) Bch Output (0dB) Bch LINE Output (4.5dB) Bch Monitor Output (-2dB)		V+/2
7 24	TONE-Ha TONE-Hb	Ach Treble Filter Bch Treble Filter		V+/2
8 23	TONE-La TONE-Lb	Ach Bass Filter Bch Bass Filter		V+/2
20	AGC	AGC Filter		0.6V

### ■TERMINAL DESCRIPTION

No.	SYMBOL	FUNCTION	EQUIVALENT CIRCUIT	VOLTAGE
11 12	CVa CVb	Pop Noise Reduction for Ach Volume & Balance Pop Noise Reduction for Bch Volume & Balance		$V+/2 - 0.7V$
13 14	SDA SCL	SDA Data Input (I <sup>2</sup> C BUS) SCL Clock Input (I <sup>2</sup> C BUS)		-
15	GND	GND Terminal	—	0V
16	V+	Power Supply Terminal	—	V+
17	Vref	Reference Voltage		$V+/2$
18 19	CTL CTH	Pop Noise reduction for Bass Control Pop Noise reduction for Treble Control		$V+/2 - 0.7V$

# NJW1141

## APPLICATION CIRCUIT

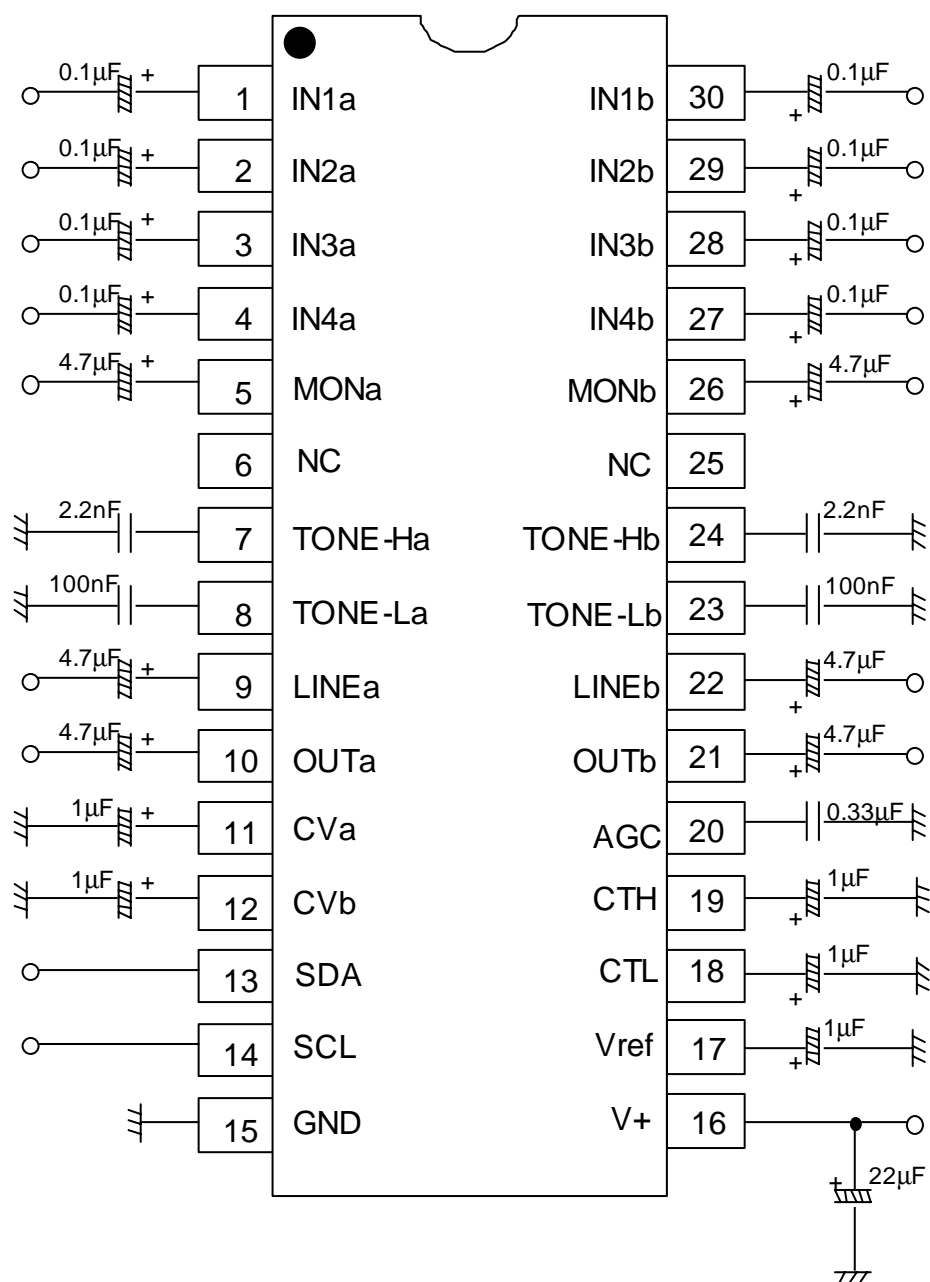

### (NOTE)

1. Separate the I<sup>2</sup>C bus line from the following terminals for avoiding digital noise problem.

Pin No.	Symbol	Pin No.	Symbol
7	TONE-Ha	23	TONE-Lb
8	TONE-La	24	TONE-Hb



## ■ DEFINITION OF I<sup>2</sup>C REGISTER

### ◆ I<sup>2</sup>C BUS FORMAT

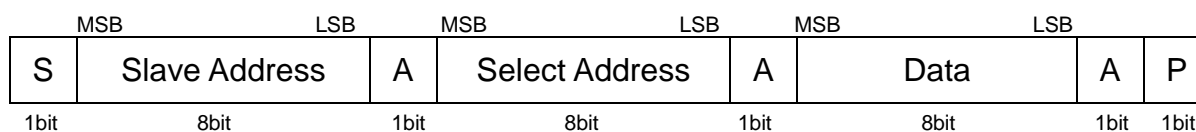

S: Starting Term

A: Acknowledge Bit

P: Ending Term

### ◆ SLAVE ADDRESS

MSB							LSB
1	0	0	0	0	0	1	R/W

$\overline{R/W}=0$ : Write mode for register setting

$\overline{R/W}=1$ : Not available

### ◆ CONTROL REGISTER TABLE

The select address sets each function (Volume, Balance, AGC, Surround, Tone Control, AUX).

The auto increment function cycles the select address as follows.

00H→01H→02H→03H→04H→05H→00H

Select Address	BIT							
	D7	D6	D5	D4	D3	D2	D1	D0
00H	VOL							
01H	CHS	BAL					Don't Care	
02H	BCB	BASS			BCSB	SUB-BASS		
03H	BCT	TREB			BCST	SUB-TREB		
04H	Don't Care							
05H	OUT	SEL			AGC1	AGC0	AGC	Don't Care

### ◆ CONTROL REGISTER DEFAULT VALUE

Control register default value is all "0".

Select Address	BIT							
	D7	D6	D5	D4	D3	D2	D1	D0
00H	0	0	0	0	0	0	0	0
01H	0	0	0	0	0	0	0	0
02H	0	0	0	0	0	0	0	0
03H	0	0	0	0	0	0	0	0
04H	0	0	0	0	0	0	0	0
05H	0	0	0	0	0	0	0	0

# NJW1141

## ■ I<sup>2</sup>C CONTROL COMMAND DESCRIPTION

### ● MASTER VOLUME CONTROL

Select Address	BIT							
	D7	D6	D5	D4	D3	D2	D1	D0
00H	VOL							

The volume control for both Ach and Bch (0.33dB/step).

The volume is consisted of volume1 and volume2 and the level is divided into half to each volume1 and volume2.

### ● BALANCE, AGC AND SURROUND SETTING

Select Address	BIT							
	D7	D6	D5	D4	D3	D2	D1	D0
01H	CHS	BAL					Don't Care	

- CHS: Channel select for balance control

“0”: Ach “Bch is attenuated”

“1”: Bch “Ach is attenuated”

- BAL: Balance control for both Ach and Bch (1dB/Step)

The balance is consisted of volume1 and volume2 and the level is divided into half to each volume1 and volume2.

### ● TONE CONTROL BASS SETTING

Select Address	BIT							
	D7	D6	D5	D4	D3	D2	D1	D0
02H	BCB	BASS				BCSB	SUB-BASS	

- BCB: Boost cut select for Bass control

“0”: Cut

“1”: Boost

- BASS: BASS control

Cut Level: -15dB to 0dB (1dB/Step)

Boost Level: 0dB to +15dB (1dB/Step)

- BCSB: Boost cut select for SUB-BASS control

“0”: Cut

“1”: Boost

- SUB-BASS: SUB- BASS control (1dB/Step)

Sub-Cut Level: -3dB to 0dB (1dB/Step)

Sub-Boost Level: 0dB to +3dB (1dB/Step)

### ●TONE CONTROL TREBLE SETTING

Select Address	BIT							
	D7	D6	D5	D4	D3	D2	D1	D0
03H	BCT	TREB				BCST	SUB-TREB	

- BCT: Boost cut select for Treble control  
 "0": Cut  
 "1": Boost
- TREB: Treble control (1dB/step)  
 Cut Level: -15dB to 0dB (1dB/Step)  
 Boost Level: 0dB to +15dB (1dB/Step)
- BCST: Boost cut select for Sub-Treble control  
 "0": Cut  
 "1": Boost
- SUB-TREB: Sub-Treble control (1dB/step)  
 Sub-Cut Level: -3dB to 0dB (1dB/Step)  
 Sub-Boost Level: 0dB to +3dB (1dB/Step)

### ●OUTPUT AND AUXILIARY SETTING

Select Address	BIT							
	D7	D6	D5	D4	D3	D2	D1	D0
05H	OUT	SEL			AGC1	AGC0	AGC	Don't Care

- OUT: ON/OFF Switch for OUTPUT  
 "0": OFF (MUTE)  
 "1": ON

- SEL: Input Selector

Input Select	SEL		
	D6	D5	D4
IN1a and IN1b	0	1	0
IN2a and IN2b	0	1	1
IN3a and IN3b	1	0	0
IN4a and IN4b	1	0	1

- AGC1: AGC Level Setting

AGC Level	AGC1 (D3)	AGC0 (D2)	AGC (D1)
300mVrms	0	0	1
400mVrms	0	1	1
500mVrms	1	0	1
600mVrms	1	1	1
AGC Off	*	*	0

\* Don't Care

# NJW1141

## ■MASTER VOLUME (Select Address: 00H)

		VOL							
Gain (dB)	HEX	D7	D6	D5	D4	D3	D2	D1	D0
0	FF	1	1	1	1	1	1	1	1
-1	FC	1	1	1	1	1	1	0	0
-2	F9	1	1	1	1	1	0	0	1
-3	F6	1	1	1	1	0	1	1	0
-4	F3	1	1	1	1	0	0	1	1
-5	F0	1	1	1	1	0	0	0	0
-6	ED	1	1	1	0	1	1	0	1
-7	EA	1	1	1	0	1	0	1	0
-8	E7	1	1	1	0	0	1	1	1
-9	E4	1	1	1	0	0	1	0	0
-10	E1	1	1	1	0	0	0	0	1
-11	DE	1	1	0	1	1	1	1	0
-12	DB	1	1	0	1	1	0	1	1
-13	D8	1	1	0	1	1	0	0	0
-14	D5	1	1	0	1	0	1	0	1
-15	D2	1	1	0	1	0	0	1	0
-16	CF	1	1	0	0	1	1	1	1
-17	CC	1	1	0	0	1	1	0	0
-18	C9	1	1	0	0	1	0	0	1
-19	C6	1	1	0	0	0	1	1	0
-20	C3	1	1	0	0	0	0	1	1
-21	C0	1	1	0	0	0	0	0	0
-22	BD	1	0	1	1	1	1	0	1
-23	BA	1	0	1	1	1	0	1	0
-24	B7	1	0	1	1	0	1	1	1
-25	B4	1	0	1	1	0	1	0	0
-26	B1	1	0	1	1	0	0	0	1
-27	AE	1	0	1	0	1	1	1	0
-28	AB	1	0	1	0	1	0	1	1
-29	A8	1	0	1	0	1	0	0	0
-30	A5	1	0	1	0	0	1	0	1
-31	A2	1	0	1	0	0	0	1	0
-32	9F	1	0	0	1	1	1	1	1
-33	9C	1	0	0	1	1	1	0	0
-34	99	1	0	0	1	1	0	0	1
-35	96	1	0	0	1	0	1	1	0
-36	93	1	0	0	1	0	0	1	1
-37	90	1	0	0	1	0	0	0	0
-38	8D	1	0	0	0	1	1	0	1
-39	8A	1	0	0	0	1	0	1	0
-40	87	1	0	0	0	0	1	1	1
-41	84	1	0	0	0	0	1	0	0
-42	81	1	0	0	0	0	0	0	1

## ■MASTER VOLUME (Cont'd)

		VOL							
Gain (dB)	HEX	D7	D6	D5	D4	D3	D2	D1	D0
-43	7E	0	1	1	1	1	1	1	0
-44	7B	0	1	1	1	1	0	1	1
-45	78	0	1	1	1	1	0	0	0
-46	75	0	1	1	1	0	1	0	1
-47	72	0	1	1	1	0	0	1	0
-48	6F	0	1	1	0	1	1	1	1
-49	6C	0	1	1	0	1	1	0	0
-50	69	0	1	1	0	1	0	0	1
-51	66	0	1	1	0	0	1	1	0
-52	63	0	1	1	0	0	0	1	1
-53	60	0	1	1	0	0	0	0	0
-54	5D	0	1	0	1	1	1	0	1
-55	5A	0	1	0	1	1	0	1	0
-56	57	0	1	0	1	0	1	1	1
-57	54	0	1	0	1	0	1	0	0
-58	51	0	1	0	1	0	0	0	1
-59	4E	0	1	0	0	1	1	1	0
-60	4B	0	1	0	0	1	0	1	1
-61	48	0	1	0	0	1	0	0	0
-62	45	0	1	0	0	0	1	0	1
-63	42	0	1	0	0	0	0	1	0
-64	3F	0	0	1	1	1	1	1	1
-65	3C	0	0	1	1	1	1	0	0
-66	39	0	0	1	1	1	0	0	1
-67	36	0	0	1	1	0	1	1	0
-68	33	0	0	1	1	0	0	1	1
-69	30	0	0	1	1	0	0	0	0
-70	2D	0	0	1	0	1	1	0	1
-71	2A	0	0	1	0	1	0	1	0
-72	27	0	0	1	0	0	1	1	1
-73	24	0	0	1	0	0	1	0	0
-74	21	0	0	1	0	0	0	0	1
-75	1E	0	0	0	1	1	1	1	0
-76	1B	0	0	0	1	1	0	1	1
-77	18	0	0	0	1	1	0	0	0
-78	15	0	0	0	1	0	1	0	1
-79	12	0	0	0	1	0	0	1	0
-80	0F	0	0	0	0	1	1	1	1
-81	0C	0	0	0	0	1	1	0	0
-82	09	0	0	0	0	1	0	0	1
-83	06	0	0	0	0	0	1	1	0
-84	03	0	0	0	0	0	0	1	1
Mute	00	0	0	0	0	0	0	0	0

# NJW1141

## ■BALANCE (Select Address: 01H)

Channel Select (CHS)	D7
Ach (Bch is attenuated)	0
Bch (Ach is attenuated)	1

Gain (dB)	BAL				
	D6	D5	D4	D3	D2
0	0	0	0	0	0
-1	0	0	0	0	1
-2	0	0	0	1	0
-3	0	0	0	1	1
-4	0	0	1	0	0
-5	0	0	1	0	1
-6	0	0	1	1	0
-7	0	0	1	1	1
-8	0	1	0	0	0
-9	0	1	0	0	1
-10	0	1	0	1	0
-11	0	1	0	1	1
-12	0	1	1	0	0
-13	0	1	1	0	1
-14	0	1	1	1	0
-15	0	1	1	1	1
-16	1	0	0	0	0
-17	1	0	0	0	1
-18	1	0	0	1	0
-19	1	0	0	1	1
-20	1	0	1	0	0
-21	1	0	1	0	1
-22	1	0	1	1	0
-23	1	0	1	1	1
-24	1	1	0	0	0
-25	1	1	0	0	1
-26	1	1	0	1	0
-27	1	1	0	1	1
-28	1	1	1	0	0
-29	1	1	1	0	1
-30	1	1	1	1	0
Mute	1	1	1	1	1

**■TONE CONTROL BASS (Select Address: 02H)**

Bass Cut or Boost	BCB
	D7
Cut	0
Boost	1

		BASS			
		D6	D5	D4	D3
Cut Gain (dB)	Boost Gain (dB)				
-15	15	1	1	1	1
-14	14	1	1	1	0
-13	13	1	1	0	1
-12	12	1	1	0	0
-11	11	1	0	1	1
-10	10	1	0	1	0
-9	9	1	0	0	1
-8	8	1	0	0	0
-7	7	0	1	1	1
-6	6	0	1	1	0
-5	5	0	1	0	1
-4	4	0	1	0	0
-3	3	0	0	1	1
-2	2	0	0	1	0
-1	1	0	0	0	1
0	0	0	0	0	0

**■TONE CONTROL SUB-BASS (Select Address: 02H)**

Sub-Bass Cut or Boost	BCSB
	D2
Cut	0
Boost	1

		SUB-BASS	
		D1	D0
Cut Gain (dB)	Boost Gain (dB)		
-3	3	1	1
-2	2	1	0
-1	1	0	1
0	0	0	0

# NJW1141

## ■TONE CONTROL TREBLE (Select Address: 03H)

Treble Cut or Boost	BCT
	D7
Cut	0
Boost	1

Cut Gain (dB) / Boost Gain (dB)		TREB			
		D6	D5	D4	D3
-15	15	1	1	1	1
-14	14	1	1	1	0
-13	13	1	1	0	1
-12	12	1	1	0	0
-11	11	1	0	1	1
-10	10	1	0	1	0
-9	9	1	0	0	1
-8	8	1	0	0	0
-7	7	0	1	1	1
-6	6	0	1	1	0
-5	5	0	1	0	1
-4	4	0	1	0	0
-3	3	0	0	1	1
-2	2	0	0	1	0
-1	1	0	0	0	1
0	0	0	0	0	0

## ■TONE CONTROL SUB-TREBLE (Select Address: 03H)

Sub-Treble Cut or Boost	BCST
	D2
Cut	0
Boost	1

Cut Gain (dB) / Boost Gain (dB)		SUB-TREB	
		D1	D1
-3	3	1	1
-2	2	1	0
-1	1	0	1
0	0	0	0



## ■ TYPICAL CHARACTERISTICS

**Supply Current vs Supply Voltage**

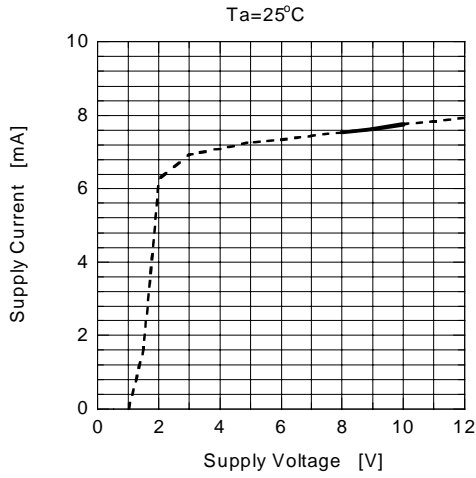

**Supply Current vs Temperature**

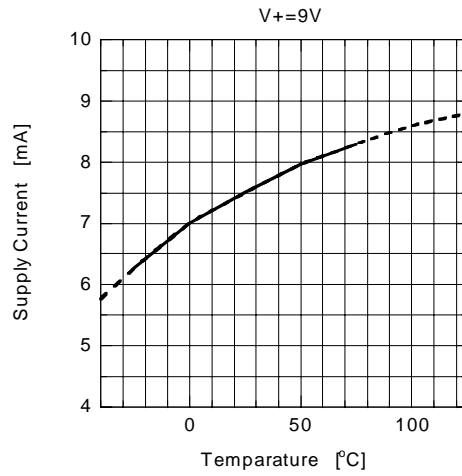

**Gain vs Volume Control**

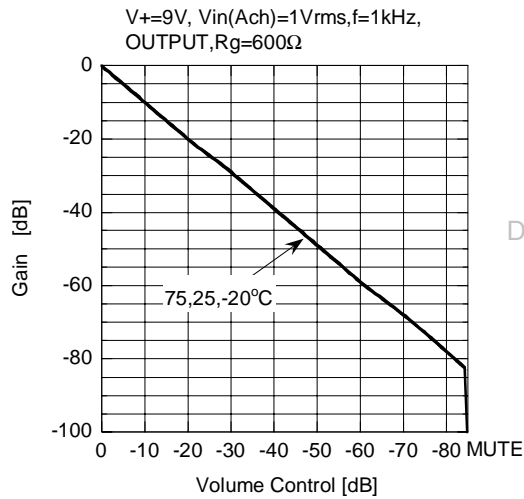

**Gain vs Balance Control**

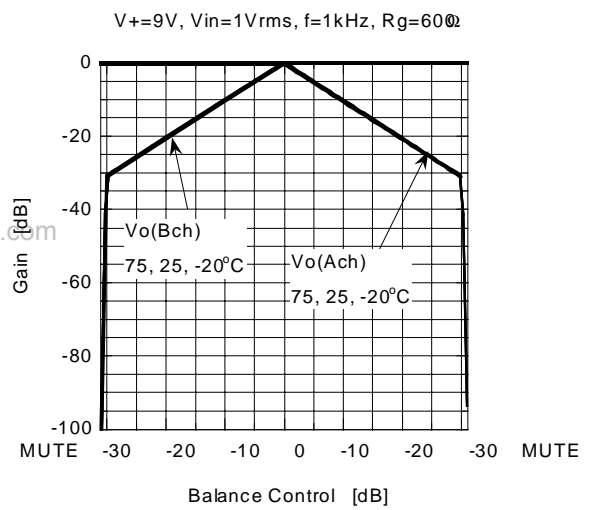

**Output Noise vs Volume Control**

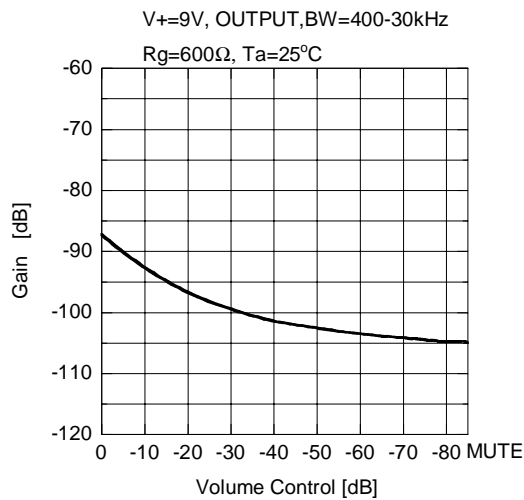

**Output Noise vs Temperature**

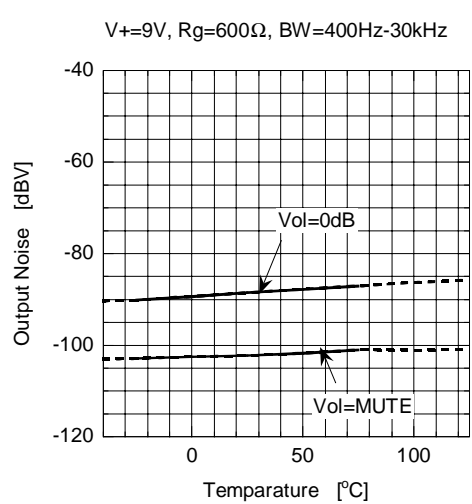

# NJW1141

## TYPICAL CHARACTERISTICS

**THD+N vs Input Voltage**

$V_{+}=9V$ ,  $V_{in}(Ach)$ ,  $f=1kHz$ ,  $V_{o}(Ach)OUTPUT$   
 $R_g=600\Omega$ ,  $BW=400Hz-30kHz$ ,  $T_a=25^{\circ}C$

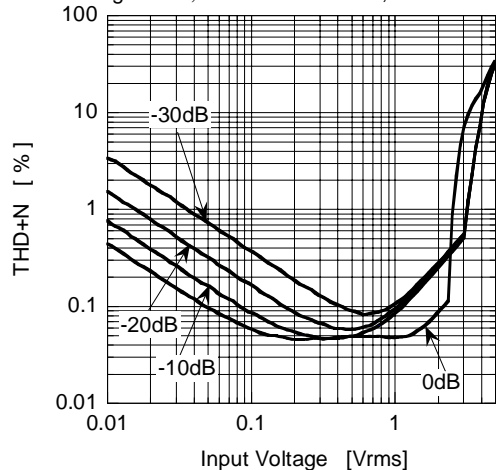

**THD+N vs Input Voltage**

$V_{+}=9V$ ,  $V_{in}(Ach)$ ,  $f=1kHz$ ,  $V_{o}(Ach)OUTPUT$   
 $R_g=600\Omega$ ,  $BW=400Hz-30kHz$ ,  $V_{ol}=-20dB$

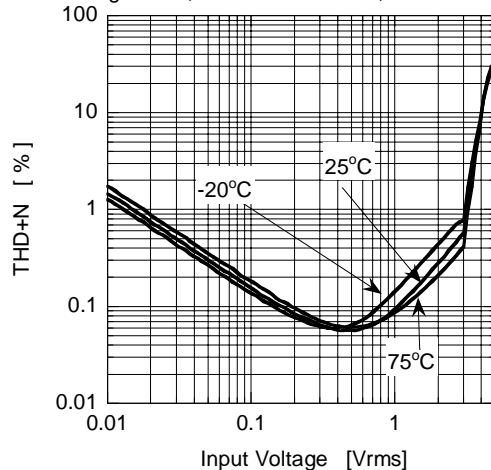

**THD+N vs Output Voltage**

$V_{+}=9V$ ,  $V_{in}(Ach)$ ,  $f=1kHz$ ,  $V_{o}(Ach)OUTPUT$   
 $BW=400Hz-30kHz$ ,  $R_g=600\Omega$ ,  $T_a=25^{\circ}C$

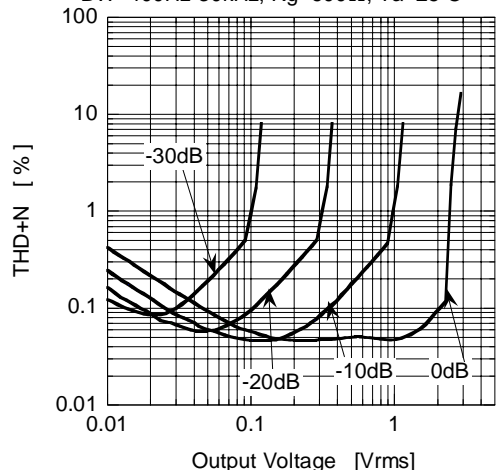

**THD+N vs Output Voltage**

$V_{+}=9V$ ,  $V_{in}(Ach)$ ,  $f=1kHz$ ,  $V_{o}(Ach)OUTPUT$   
 $R_g=600\Omega$ ,  $BW=400Hz-30kHz$ ,  $V_{ol}=0dB$

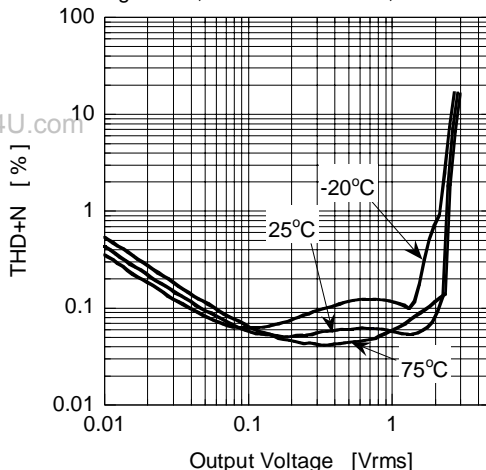

**MUTE Level vs Frequency**

$V_{+}=9V$ ,  $V_{in}(Ach)=1V_{rms}$ ,  $V_{ol}=MUTE$   
 $V_{o}(Ach)OUTPUT$ ,  $R_g=600\Omega$ ,  $T_a=25^{\circ}C$

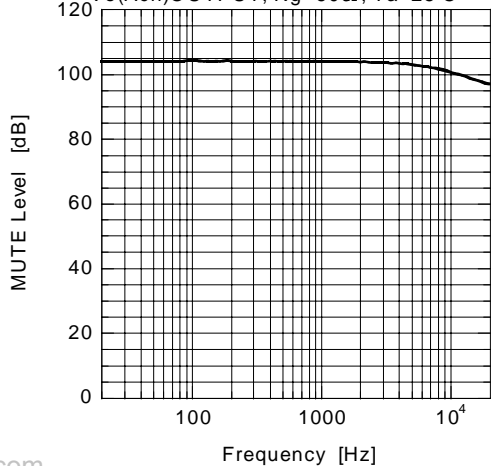

**Channel Separation vs Frequency**

$V_{+}=9V$ ,  $V_{in}=1V_{rms}$ ,  $f=1kHz$ ,  $V_{o}=OUTPUT$   
 $R_g=600\Omega$ ,  $V_{ol}=0dB$ ,  $T_a=25^{\circ}C$

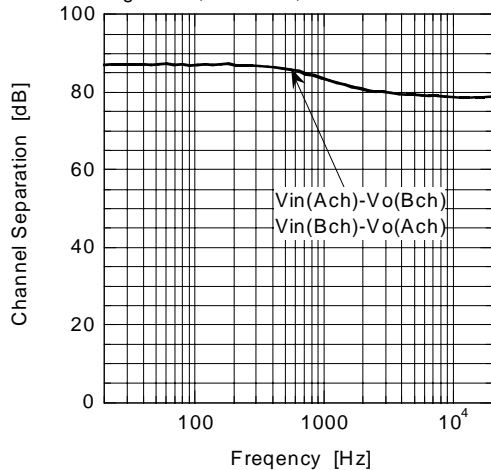

## ■ TYPICAL CHARACTERISTICS

### Gain vs Frequency (TONE)

$V_+ = 9V$ ,  $V_{in(Ach)} = 0.1V_{rms}$ ,  $G_v: 3dB$  steps  
 $V_o(Ach)$ ,  $R_g = 600\Omega$ ,  $T_a = 25^\circ C$

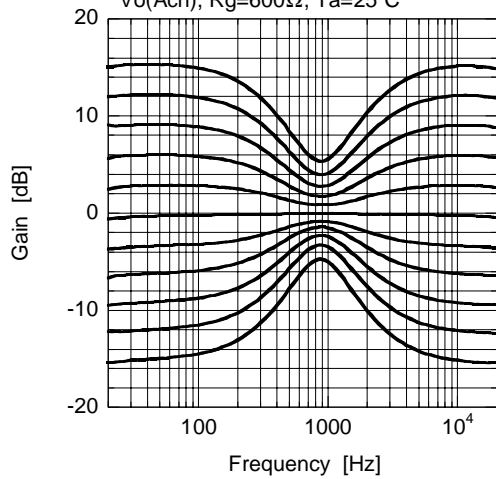

### AGC Control

$V_+ = 9V$ ,  $V_{in(Ach+Bch)}$ ,  $f = 1kHz$ ,  $V_o(Ach)$  OUTPUT  
 $R_g = 600\Omega$ ,  $T_a = 25^\circ C$

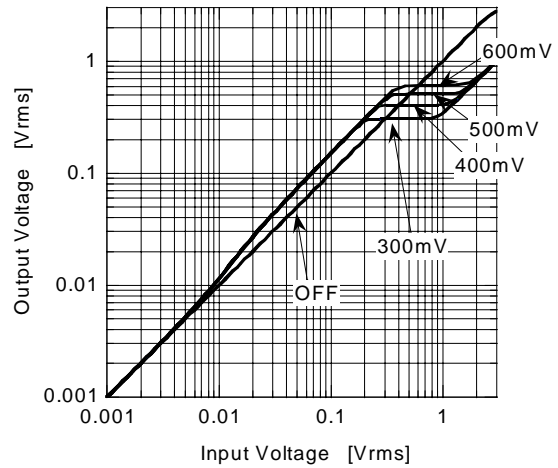

### AGC Attack Time (C:20pin=0.33μF)

$V_+ = 9V$ ,  $V_{in(Ach+Bch)} = 1V_{rms}$ ,  $f = 20kHz$ ,  $V_o(Ach)$  OUTPUT  
 AGC level = 0.3V,  $R_g = 600\Omega$ ,  $T_a = 25^\circ C$

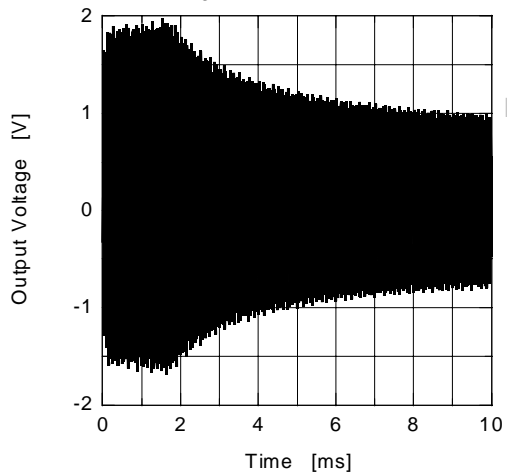

### AGC Recovery Time (C:20pin=0.33μF)

$V_+ = 9V$ ,  $V_{in(Ach+Bch)} = 1V_{rms}$ ,  $f = 10kHz$ ,  $V_o(Ach)$  OUTPUT  
 AGC level = 0.3V,  $R_g = 600\Omega$ ,  $T_a = 25^\circ C$

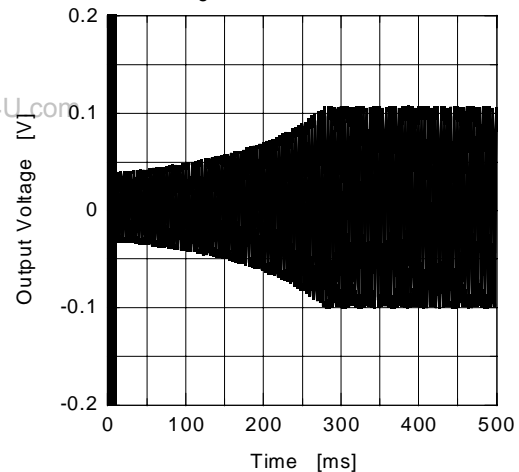

# NJW1141

---

et4U.com

DataSheet4U.com

**[CAUTION]**

The specifications on this databook are only given for information, without any guarantee as regards either mistakes or omissions. The application circuits in this databook are described only to show representative usages of the product and not intended for the guarantee or permission of any right including the industrial rights.