

SOUND PROCESSOR with SOUND ENHANCEMENT

■ GENERAL DESCRIPTION

The **NJW1152** is a sound processor with sound enhancement (BBE). It includes all of functions processing audio signal for TV, such as tone control, balance, volume, mute, and AGC functions.

Also the **NJW1152** performs surround and sound enhancement. The sound enhancement regenerates high definitive and nearly real sound.

All of internal status and variables are controlled by I²C BUS Interface.

■ PACKAGE OUTLINE

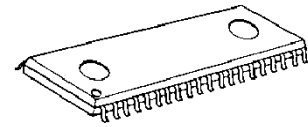

NJW1152G

■ FEATURES

- Operating Voltage 8 to 13V
- I²C BUS Interface
- Low Noise Master Volume
- BBE Sound Enhancement (Low Boost and High Boost: 12dB max.)
- AGC circuit.
- Original 3D Surround/Simulated Stereo
- Bi-CMOS Technology
- Package Outline SOP40

■ BLOCK DIAGRAM

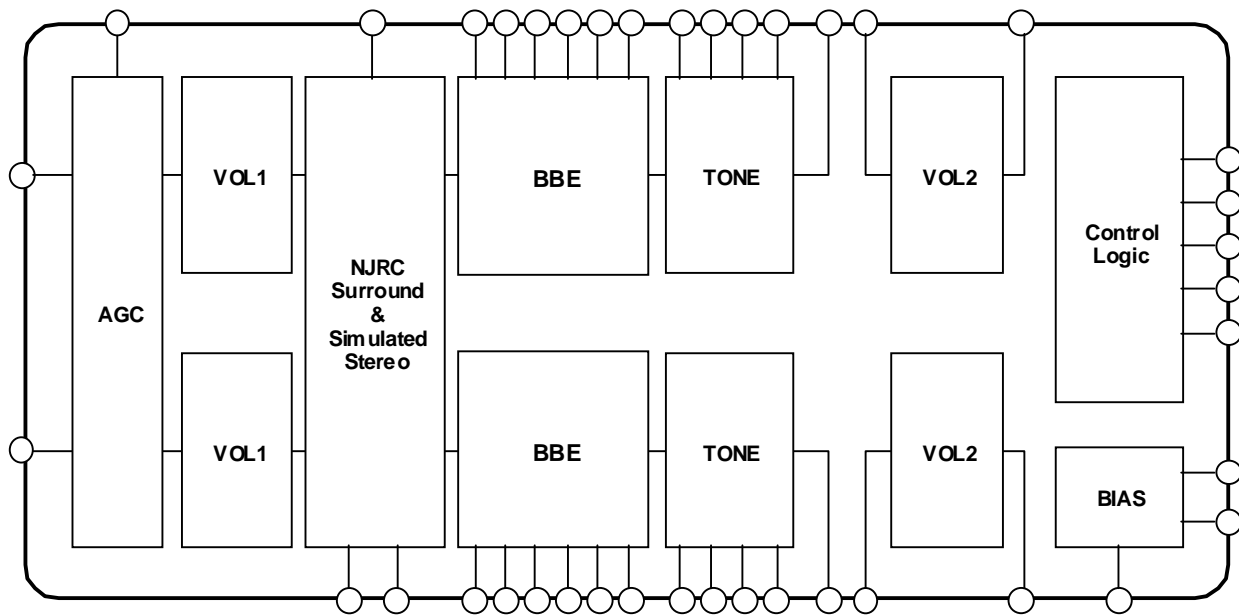

■ PIN FUNCTION

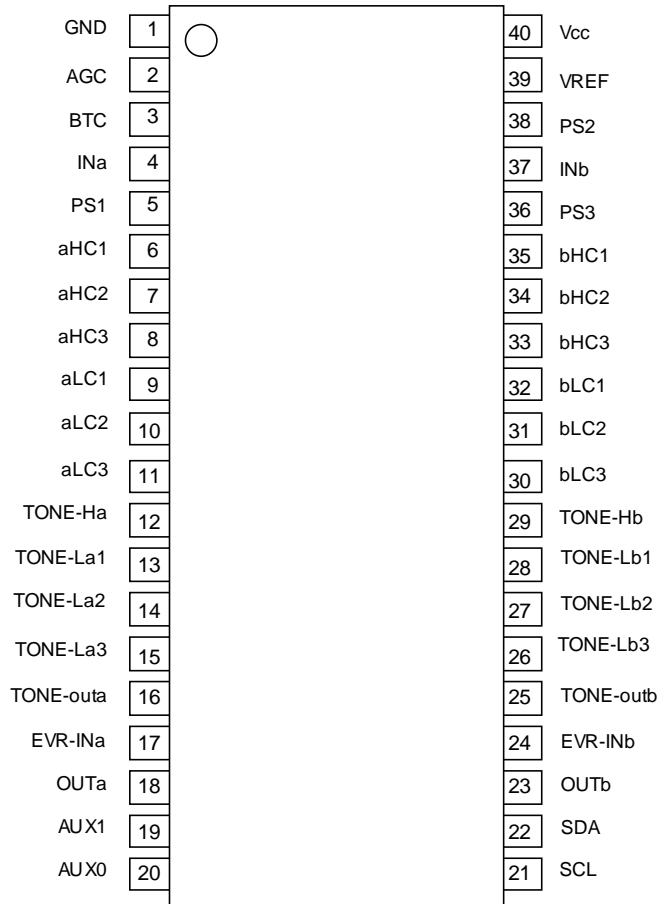

No.	Symbol	Function	No.	Symbol	Function
1	GND	GND	21	SCL	I ² C BUS Clock Terminal
2	AGC	AGC Response Control Terminal	22	SDA	I ² C BUS Data Terminal
3	BTC	BBE Filter Terminal	23	OUTa	Bch Output
4	INa	Ach Input Terminal	24	EVR-INb	Bch VOL2 Input Terminal
5	PS1	Surround Filter Terminal	25	TONE-outb	Bch Tone Control Output
6	aHC1	BBE Filter Terminal	26	TONE-Lb3	Tone Control (Bass) Filter Terminal
7	aHC2	BBE Filter Terminal	27	TONE-Lb2	Tone Control (Bass) Filter Terminal
8	aHC3	BBE Filter Terminal	28	TONE-Lb1	Tone Control (Bass) Filter Terminal
9	aLC1	BBE Filter Terminal	29	TONE-Hb	Tone Control (Treble) Filter Terminal
10	aLC2	BBE Filter Terminal	30	bLC3	BBE Filter Terminal
11	aLC3	BBE Filter Terminal	31	bLC2	BBE Filter Terminal
12	TONE-Ha	Tone Control (Treble) Filter Terminal	32	bLC1	BBE Filter Terminal
13	TONE-La1	Tone Control (Bass) Filter Terminal	33	bHC3	BBE Filter Terminal
14	TONE-La2	Tone Control (Bass) Filter Terminal	34	bHC2	BBE Filter Terminal
15	TONE-La3	Tone Control (Bass) Filter Terminal	35	bHC1	BBE Filter Terminal
16	TONE-outa	Ach Tone Control Output	36	PS3	Surround Filter Terminal
17	EVR-INa	Ach VOL2 Input Terminal	37	INb	Bch Input Terminal
18	OUTa	Ach Output	38	PS2	Surround Filter Terminal
19	AUX1	Auxiliary Output Terminal	39	VREF	Reference Voltage Terminal
20	AUX0	Auxiliary Output Terminal	40	Vcc	Voltage Terminal

■ ABSOLUTE MAXIMUM RATING (Ta=25°C)

PARAMETER	SYMBOL	RATING	UNIT
Supply Voltage	V ⁺	14	V
Power Dissipation	P _D	700	mW
Operating Temperature Range	T _{opr}	-40 to +85	°C
Storage Temperature Range	T _{stg}	-40 to +125	°C

■ ELECTRICAL CHARACTERISTICS

(Ta=25°C, V+=9V, Rg=600Ω, RL=47kΩ, Vin=100mVrms/1kHz, Vol1/Vol2a/Vol2b=0dB, AGC=OFF, BBE=0dB, TONE=0dB, Surround=OFF unless otherwise specified)

PARAMETER	SYMBOL	TEST CONDITION	MIN.	TYP.	MAX.	UNIT
Operating Voltage	V+		8.0	9.0	13.0	V
Supply Current	I _{CC}	No Signal	-	25	40	mA
Reference Voltage	V _{REF}	No Signal	4.0	4.5	5.0	V
Maximum Input Voltage	V _{IM}	Vol1=-20dB, Vol2a/2b=0dB, THD=1%	2.6	2.8	-	Vrms
Maximum Output Voltage	V _{OM1}	OUTPUT THD=1%	2.2	2.5	-	Vrms
Maximum Gain	G _{VMAX}		-2.0	0.0	2.0	dB
Minimum Gain	G _{VMIN}	Vol1/Vol2a/Vol2b= -40dB	-84	-80	-76	dB
Channel Balance	G _{CB}		-1.5	0.0	1.5	dB
Total Harmonic Distortion	THD	Vo=0.5Vrms BW=400Hz to 30kHz	-	0.01	0.05	%
Mute Level	MUTE	Vol1/Vol2a/Vol2b= Mute	-	-	-90	dB
Channel Separation	CS	Vin=2Vrms	-	-80	-70	dB
Output Noise 1	V _{NO1}	BW=400Hz to 30kHz	-	-100 (10.0)	-	dBV (μVrms)
Output Noise 2	V _{NO2}	Vol1/Vol2a/Vol2b= Mute BW=400Hz to 30kHz	-	-110 (3.2)	-100 (10.0)	dBV (μVrms)

● TONE CONTROL

PARAMETER	SYMBOL	TEST CONDITION	MIN.	TYP.	MAX.	UNIT
High Frequency Boost	HF _{BST}	TREBE=12dB, f=20kHz	10	12.0	14.0	dB
High Frequency Flat	HF _{FLT}	TRBE=0dB, f=20kHz	-2.0	0.0	2.0	dB
High Frequency Cut	HF _{CUT}	TREBLE=-12dB, f=20kHz	-14	-12.0	-10.0	dB
Low Frequency Boost	LF _{BST}	BASS=12dB, f=50Hz	10.0	12.0	14.0	dB
Low Frequency Flat	LF _{FLT}	BASS=0dB, f=50Hz	-2.0	0.0	2.0	dB
Low Frequency Cut	LF _{CUT}	BASS=-12dB, f=50Hz	-14.0	-12.0	-10.0	dB

● AGC CONTROL: AGC= H (AGC-ON)

PARAMETER	SYMBOL	TEST CONDITION	MIN.	TYP.	MAX.	UNIT
AGC BOOST	AGC _{BST}	Vin=50mVrms	2.0	3.0	4.0	dB
AGC FLAT L	AGC _{FLTL}	Vin=100mVrms AGCLVL=" 1"	-2.5	0.0	2.5	dB
AGC FLAT M	AGC _{FLTM}	Vin=200mVrms AGCLVL=" 2"	-2.5	0.0	2.5	dB
AGC FLAT H	AGC _{FLTH}	Vin=400mVrms AGCLVL=" 3"	-2.5	0.0	2.5	dB
AGC CUT 3	AGC _{CUT3}	Vin=2Vrms AGCLVL=" 3"	-16	-12	-8.0	dB

● SURROUND CONTROL (SURROUND-ON)

PARAMETER	SYMBOL	TEST CONDITION	MIN.	TYP.	MAX.	UNIT
SURROUND Gain 1	G _{VSUR1}	Ain → Aout, f=100Hz Surround="Sur1 "	6.5	8.5	10.5	dB
SURROUND Gain 2	G _{VSUR2}	Ain → Bout, f=100Hz Surround="Sur1 "	2.5	4.5	6.5	dB
SURROUND Gain 3	G _{VSUR3}	Ain → Aout, f=100Hz Surround="Sur2 "	10	12	14	dB
SURROUND Gain 4	G _{VSUR4}	Ain → Bout, f=100Hz Surround="Sur2 "	7.5	9.5	11.5	dB
Simulated Stereo Gain1	G _{VSST1}	Ain+Bin → Aout, Surround="SST"	1.0	3.0	5.0	dB
Simulated Stereo Gain2	G _{VSST2}	Ain+Bin → Bout, Surround="SST"	1.0	3.0	5.0	dB

● BBE (BBE ON)

PARAMETER	SYMBOL	TEST CONDITION	MIN.	TYP.	MAX.	UNIT
BBE low Frequency Boost Range	BBE _{LOW}	BBE-Low=12dB	-	12.0	-	dB
BBE High Frequency Boost Range	BBE _{HIGH}	BBE-High=12dB	-	12.0	-	dB

● AUXILIARY OUTPUT

PARAMETER	SYMBOL	TEST CONDITION	MIN.	TYP.	MAX.	UNIT
Low level Output Voltage	V _{OL}	I _{OL} =1mA	-	0.5	1.5	V
High level Output Voltage	V _{OH}	I _{OH} =1mA	3.5	4.5	-	V

■ I²C BUS BLOCK CHARACTERISTICS (SDA,SCL)

PARAMETER	SYMBOL	MIN.	TYP.	MAX.	UNIT
High Level Input Voltage	V _{IH}	3.0	-	5.0	V
Low Level Input Voltage	V _{IL}	0	-	1.5	V
High Level Input Current	I _{IH}	-	-	10	μA
Low Level Input Current	I _{IL}	-	-	10	μA
Low Level Output Voltage (3mA at SDA pin)	V _{OL}	0	-	0.4	dB
Maximum Output Current	I _{OL}	-3.0	-	-	mA
Maximum Clock Frequency	f _{SCL}	0	-	100	kHz
Data Change Minimum Waiting Time	t _{BUF}	4.7	-	-	μs
Data Transfer Start Minimum Waiting Time	t _{HD:STA}	4.0	-	-	μs
Low Level Clock Pulse Width	t _{LOW}	4.7	-	-	μs
High Level Clock Pulse Width	T _{HIGH}	4.0	-	-	μs
Minimum Start Preparation Waiting Time	t _{SU:STA}	4.7	-	-	μs
Minimum Data Hold Time	t _{HD:DAT}	5.0	-	-	μs
Minimum Data Preparation Time	t _{SU:DAT}	250	-	-	ns
Rise Time	t _R	-	-	1.0	μs
Fall Time	t _F	-	-	300	ns
Minimum Stop Preparation Waiting Time	t _{SU:STO}	4.7	-	-	μs

I²C BUS Load Condition: Pull up resistance 4kΩ (Connected to +5V)
Load capacitance 200pF (Connected to GND)

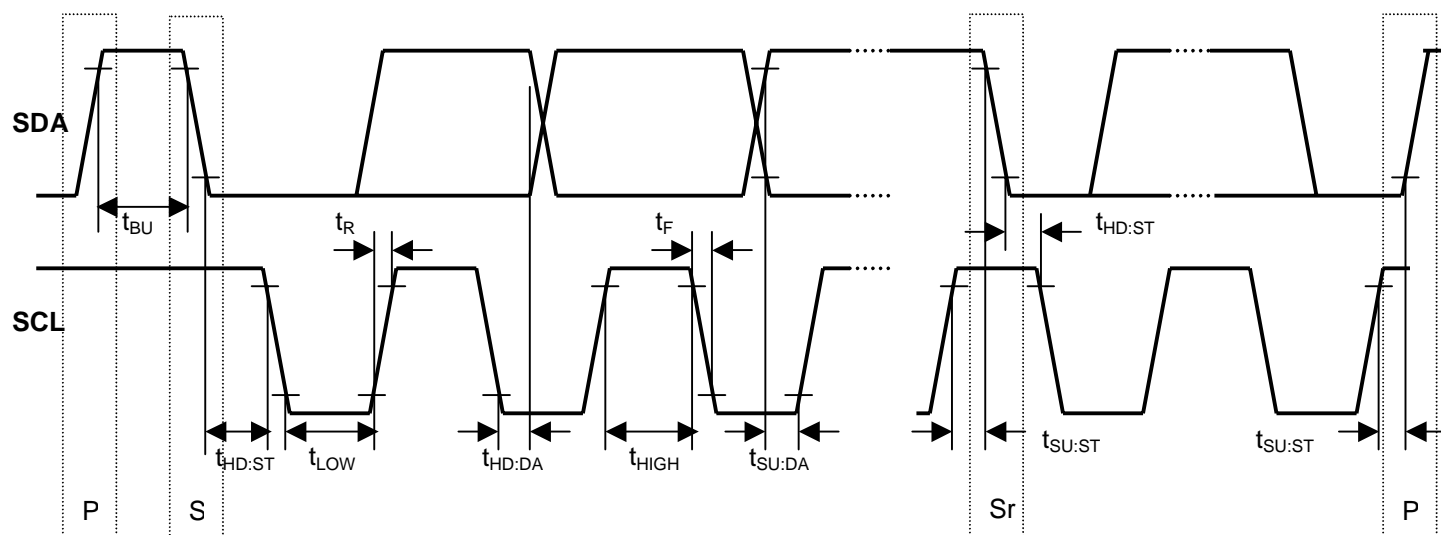

■TERMINAL DESCRIPTION

No.	SYMBOL	FUNCTION	EQUIVALENT CIRCUIT	VOLTAGE
1 40	GND Vcc	Power Supply		-
2	AGC	AGC Response Control		1.4V
3	BTC	Terminal for BBE		Vcc/2
4 37	Ina Inb	a/b ch Input Terminal		Vcc/2
5	PS1	Filter for Surround		Vcc/2

■TERMINAL DESCRIPTION

No.	SYMBOL	FUNCTION	EQUIVALENT CIRCUIT	VOLTAGE
6 35	aHC1 bHC1	Filter for BBE		$V_{cc}/2$
7 34	aHC2 bHC2	Filter for BBE		$V_{cc}/2$
8 11 30 33	aHC3 aLC3 bLC3 bHC3	Filter for BBE		$V_{cc}/2$
9 32	aLC1 bLC1	Filter for BBE		$V_{cc}/2$
10 31	aLC2 bLC2	Filter for BBE		$V_{cc}/2$

■TERMINAL DESCRIPTION

No.	SYMBOL	FUNCTION	EQUIVALENT CIRCUIT	VOLTAGE
12 29	TONE-Ha TONE-Hb	Filter for TONE Control		$V_{cc}/2$
13 28	TONE-La1 TONE-Lb1	Filter for TONE Control		$V_{cc}/2$
14 15 26 27	TONE-La2 TONE-La3 TONE-Lb3 TONE-Lb2	Filter for TONE Control		$V_{cc}/2$
16 25	TONE-outa TONE-outb	Output		$V_{cc}/2$
17 24	EVR-INa EVR-INb	Input terminal		$V_{cc}/2$

■TERMINAL DESCRIPTION

No.	SYMBOL	FUNCTION	EQUIVALENT CIRCUIT	VOLTAGE
18 23	OUTa OUTb	Output		Vcc/2
19 20	AUX1 AUX0	Auxiliary Output		L=0V H=5V
21	SCL	I ² C Bus Clock Input		L=0V H=5V
22	SDA	I ² C Bus Data Input		L=0V H=5V
36	PS3	Filter for Surround		Vcc/2

■TERMINAL DESCRIPTION

No.	SYMBOL	FUNCTION	EQUIVALENT CIRCUIT	VOLTAGE
38	PS2	Filter for Surround		-
39	VREF	Reference Voltage		$V_{cc}/2$

APPLICATION CIRCUIT

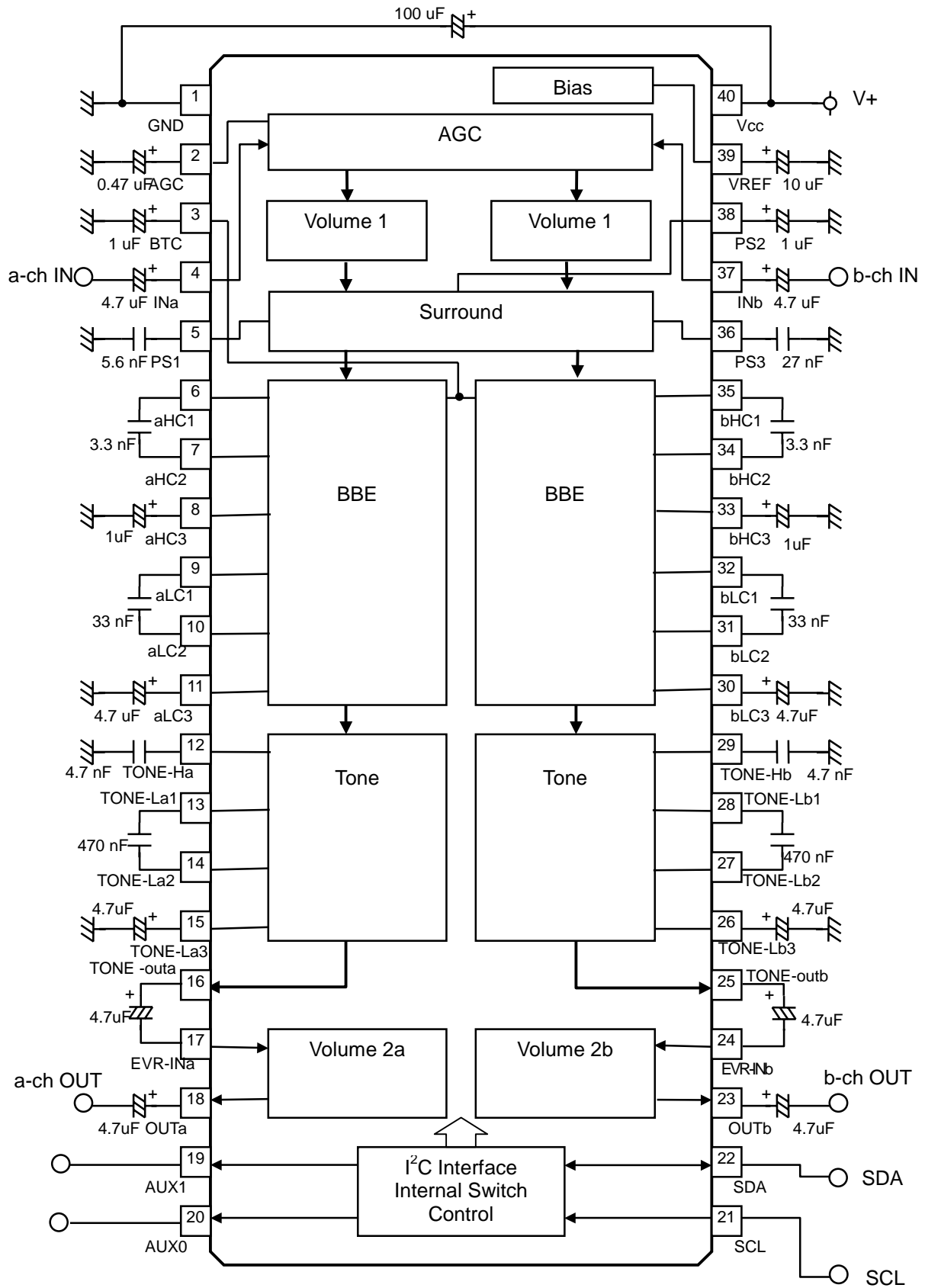

■ DEFINITION OF I²C REGISTER

● I²C BUS FORMAT

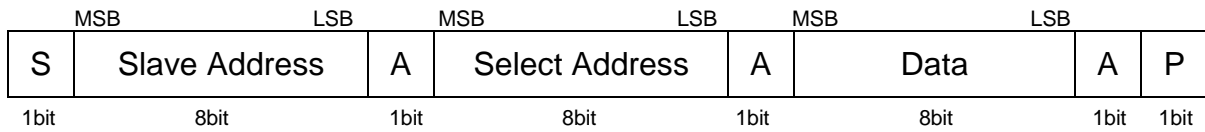

S: Starting Term
 A: Acknowledge Bit
 P: Ending Term

● SLAVE ADDRESS

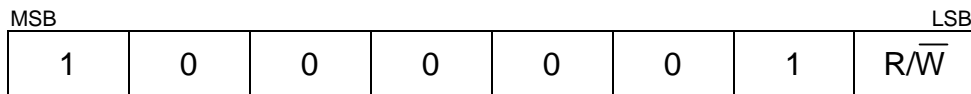

R/W=0: Receive Only
 R/W=1: No Output Data

● CONTROL REGISTER TABLE

Select Address	BIT							
	D7	D6	D5	D4	D3	D2	D1	D0
00H	Volume 1							
01H	*	Volume 2a						
02H	Volume 2b							
03H	TONE (Treble)				TONE(Bass)			
04H	BBE-Low				BBE-High			
05H	*	AUX1	AUX0	Surround		AGC Gain		AGC
06H	TEST mode (Normally not available. Set 00H.)							

* : Don't Care

Auto Increment : The selected Address is incremented with the number of Data.

0H → 1H → 2H → 3H → 4H → 5H → 6H



● CONTROL REGISTER DEFAULT VALUE

Select Address	BIT							
	D7	D6	D5	D4	D3	D2	D1	D0
00H	0	0	0	0	0	0	0	0
01H	0	0	0	0	0	0	0	0
02H	0	0	0	0	0	0	0	0
03H	0	0	0	0	0	0	0	0
04H	0	0	0	0	0	0	0	0
05H	0	0	0	0	0	0	0	0
06H	0	0	0	0	0	0	0	0

■ Volume1/2a/2b (Select Address = 00H,01H,02H)

Gain (dB)	VOL1/2a/2b							
	D7	D6	D5	D4	D3	D2	D1	D0
0			1	1	1	1	1	1
-1			1	1	1	1	1	0
-2			1	1	1	1	0	1
-3			1	1	1	1	0	0
-4			1	1	1	0	1	1
-5			1	1	1	0	1	0
-6			1	1	1	0	0	1
-7			1	1	1	0	0	0
-8			1	1	0	1	1	1
-9			1	1	0	1	1	0
-10			1	1	0	1	0	1
-11			1	1	0	1	0	0
-12			1	1	0	0	1	1
-13			1	1	0	0	1	0
-14			1	1	0	0	0	1
-15			1	1	0	0	0	0
-16			1	0	1	1	1	1
-17			1	0	1	1	1	0
-18			1	0	1	1	0	1
-19			1	0	1	1	0	0
-20			1	0	1	0	1	1
-21	*		1	0	1	0	1	0
-22			1	0	1	0	0	1
-23			1	0	1	0	0	0
-24			1	0	0	1	1	1
-25			1	0	0	1	1	0
-26			1	0	0	1	0	1
-27			1	0	0	1	0	0
-28			1	0	0	0	1	1
-29			1	0	0	0	1	0
-30			1	0	0	0	0	1
-31			1	0	0	0	0	0
-32			0	1	1	1	1	1
-33			0	1	1	1	1	0
-34			0	1	1	1	0	1
-35			0	1	1	1	0	0
-36			0	1	1	0	1	1
-37			0	1	1	0	1	0
-38			0	1	1	0	0	1
-39			0	1	1	0	0	0
-40			0	1	0	1	1	1
Mute			0	0	0	0	0	0

* : Don't Care

■ TONE Control(Treble / Bass ,Select Address = 03H)

Boost/Cut Gain(dB)	TREBLE				BASS			
	D7	D6	D5	D4	D3	D2	D1	D0
12	1	1	1	0	1	1	1	0
10	1	1	0	1	1	1	0	1
8	1	1	0	0	1	1	0	0
6	1	0	1	1	1	0	1	1
4	1	0	1	0	1	0	1	0
2	1	0	0	1	1	0	0	1
0	1	0	0	0	1	0	0	0
0	0	0	0	0	0	0	0	0
-2	0	0	0	1	0	0	0	1
-4	0	0	1	0	0	0	1	0
-6	0	0	1	1	0	0	1	1
-8	0	1	0	0	0	1	0	0
-10	0	1	0	1	0	1	0	1
-12	0	1	1	0	0	1	1	0

■ BBE Lo Contour / Process , Select Address = 04H)

Boost Gain(dB)	Process				Lo Contour			
	D7	D6	D5	D4	D3	D2	D1	D0
12	1	1	0	0	1	1	0	0
11	1	0	1	1	1	0	1	1
10	1	0	1	0	1	0	1	0
9	1	0	0	1	1	0	0	1
8	1	0	0	0	1	0	0	0
7	0	1	1	1	0	1	1	1
6	0	1	1	0	0	1	1	0
5	0	1	0	1	0	1	0	1
4	0	1	0	0	0	1	0	0
3	0	0	1	1	0	0	1	1
2	0	0	1	0	0	0	1	0
1	0	0	0	1	0	0	0	1
0	0	0	0	0	0	0	0	0

■ Auxiliary Port Control

	D6 AUX1	D5 AUX0
High	1	1
Low	0	0

■ AGC Function Control

	D0
ON	0
OFF	1

■ Surround Control

	D4	D3
OFF	0	0
Simulated STEREO	0	1
Surround 1	1	0
Surround 2	1	1

■ AGC Level Control

	D2	D1
Level 1	0	0
Level 2	0	1
Level 3	1	0

■NOTE

The **NJW1152** is manufactured by New Japan Radio Co., Ltd. under license from BBE Sound Inc.

BBE is a registered trademark of BBE Sound Inc.

A license from BBE Sound Inc. is required before the **NJW1152** can be purchased from New Japan Radio Co.,Ltd.

BBE Sound, Inc.
 5381 Production Drive
 Huntington Beach, CA 92649
 Tel:(714)897-6766
 Fax:(714)896-0736

Purchase of I²C components of New Japan Radio Co., Ltd or one of its sublicensed Associated Companies conveys a license under the Philips I²C Patent Rights to use these components in an I²C system, provided that the system conforms to the I²C Standard Specification as defined by Philips.

[CAUTION]
 The specifications on this databook are only given for information, without any guarantee as regards either mistakes or omissions. The application circuits in this databook are described only to show representative usages of the product and not intended for the guarantee or permission of any right including the industrial rights.