

## 6-CHANNEL ELECTRONIC VOLUME WITH INPUT SELECTOR

### GENERAL DESCRIPTION

NJW1153 is a 6-channel electronic volume IC. It includes Input selector, tone control, volume, mute, input selector gain control, volume output gain control and 3 REC outputs. Each mode and conditions are set by the 3-wired serial control data.

### PACKAGE OUTLINE

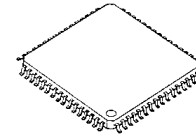

NJW1153FG1

### FEATURES

- Operating Voltage
- 3-Wired Serial Control
- Input Selector (x 8)
- REC Output (x 3)
- Input Selector Gain Control
- Volume Output Gain Control
- Volume
- Tone Control
- Subwoofer output addition to L, R channel output
- Subwoofer output ON/OFF control
- Bi-CMOS Technology
- Package Outline

±4.5 to ±7.5V

Gain : 0/-3/-6/-9/-12dB

Gain : 0/+3/+6/+9/+12/+15/+18dB

0 to -100dB/1dBstep, MUTE

0 to ±10dB/1dBstep

QFP64 - G1

### BLOCK DIAGRAM

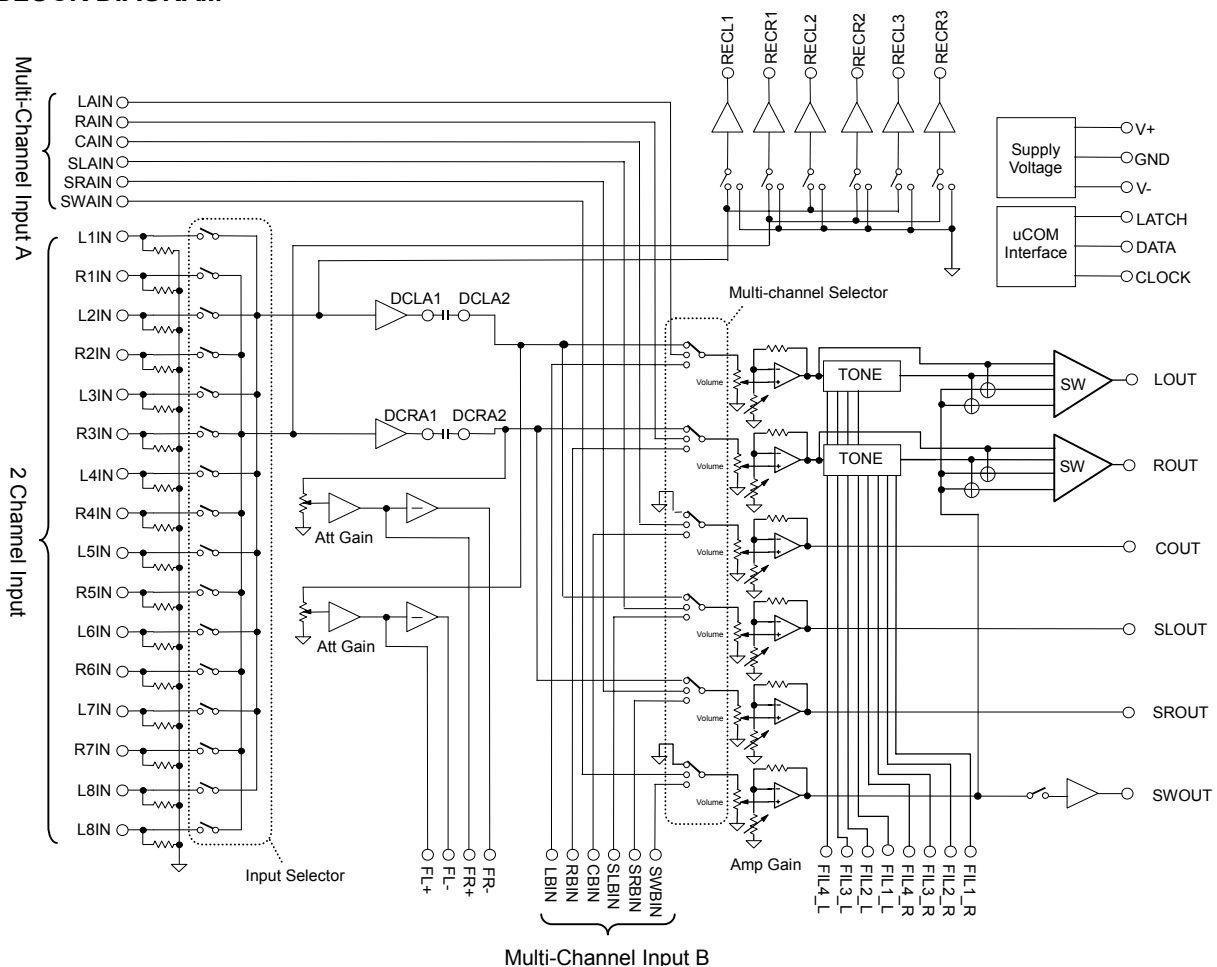

## ■ PIN FUNCTION

www.datasheet4u.com

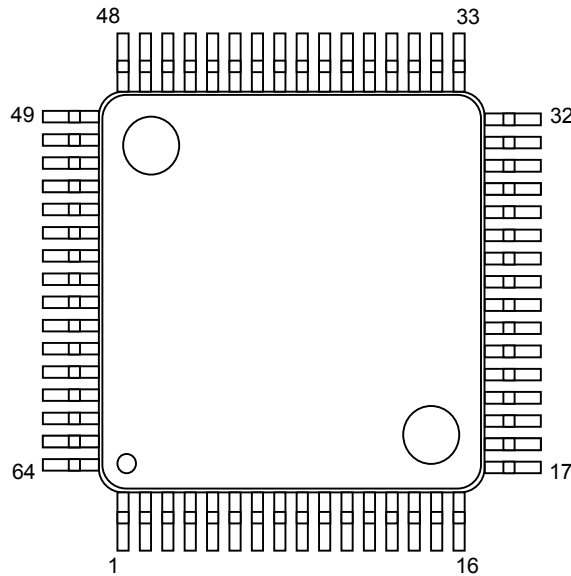

No.	SYMBOL	FUNCTION	No.	SYMBOL	FUNCTION
1	FIL2_R	Rch Bass filter terminal	33	RAIN	Multi-channel Rch input A
2	FIL3_R	Rch Bass filter DC cut capacitor output terminal	34	CAIN	Multi-channel Cch input A
3	FIL4_R	Rch Bass filter DC cut capacitor input terminal	35	SLAIN	Multi-channel SLch input A
4	GND	Ground	36	SRAIN	Multi-channel SRch input A
5	FL+	"Input selector gain control" Lch no-inverted output	37	SWAIN	Multi-channel SWch input A
6	FL-	"Input selector gain control" Lch inverted output	38	LBIN	Multi-channel Lch input B
7	FR+	"Input selector gain control" Rch no-inverted output	39	RBIN	Multi-channel Rch input B
8	FR-	"Input selector gain control" Rch inverted output	40	CBIN	Multi-channel Cch input B
9	DCLA1	"Input selector" Lch output	41	SLBIN	Multi-channel Lch input B
10	DCLA2	"Multi-channel selector" Lch input	42	SRBIN	Multi-channel SRch input B
11	DCRA1	"Input selector" Rch output	43	SWBIN	Multi-channel SWch input B
12	DCRA2	"Multi-channel selector" Rch input	44	SurTC	Switching noise rejection capacitor
13	L1IN	"Input selector" Lch input 1	45	FIL4_L	Lch Bass filter DC cut capacitor input terminal
14	R1IN	"Input selector" Rch input 1	46	FIL3_L	Lch Bass filter DC cut capacitor output terminal
15	L2IN	"Input selector" Lch input 2	47	FIL2_L	Lch Bass filter terminal
16	R2IN	"Input selector" Rch input 2	48	FIL1_L	Lch Treble filter terminal
17	L3IN	"Input selector" Lch input 3	49	LOUT	Lch output
18	R3IN	"Input selector" Rch input 3	50	ROUT	Rch output
19	L4IN	"Input selector" Lch input 4	51	COUT	Cch output
20	R4IN	"Input selector" Rch input 4	52	SLOUT	SLch output
21	L5IN	"Input selector" Lch input 5	53	SROUT	SRch output
22	R5IN	"Input selector" Rch input 5	54	SWOUT	SWch output
23	L6IN	"Input selector" Lch input 6	55	V+	+ Power supply voltage input
24	R6IN	"Input selector" Rch input 6	56	GND	Ground
25	L7IN	"Input selector" Lch input 7	57	V-	- Power supply voltage input
26	R7IN	"Input selector" Rch input 7	58	RECL1	"Input selector" Lch REC output 1
27	L8IN	"Input selector" Lch input 8	59	RECR1	"Input selector" Rch REC output 1
28	R8IN	"Input selector" Rch input 8	60	RECL2	"Input selector" Lch REC output 2
29	DATA	Control data signal input	61	RECR2	"Input selector" Rch REC output 2
30	CLOCK	Clock signal input	62	RECL3	"Input selector" Lch REC output 3
31	LATCH	Latch signal input	63	RECR3	"Input selector" Rch REC output 3
32	LAIN	Multi-channel Lch input A	64	FIL1_R	Rch Treble filter terminal

## ■ ABSOLUTE MAXIMUM RATING (Ta=25°C)

PARAMETER	SYMBOL	RATING	UNIT
Power Supply Voltage	V <sub>+</sub> /V <sub>-</sub>	+7.5/-7.5	V
Maximum Input Voltage	V <sub>IM</sub>	V <sub>+</sub> /V <sub>-</sub>	V
Power Dissipation	P <sub>D</sub>	700	mW
Operating Temperature Range	Topr	-40 to +85	°C
Storage Temperature Range	Tstg	-40 to +125	°C

## ■ ELECTRICAL CHARACTERISTICS (Ta=25°C, V<sub>+</sub>/V<sub>-</sub>=±7V)

PARAMETER	SYMBOL	TEST CONDITION	MIN.	TYP.	MAX.	UNIT
-----------	--------	----------------	------	------	------	------

### ◆ Power Supply

Operating Voltage 1	V <sub>+</sub>		4.5	7.0	7.5	V
Operating Voltage 2	V <sub>-</sub>		-7.5	-7.0	-4.5	V
Supply Current 1	I <sub>CC</sub>	No signal	-	20	34	mA
Supply Current 2	I <sub>EE</sub>	No signal	-	20	34	mA

### ◆ Input/Output Characteristics (Output)

Maximum Output Voltage	V <sub>OM</sub>	f=1KHz, THD=1% Volume=0dB	3.0	4.0	-	V <sub>rms</sub>
Voltage Gain	G <sub>V</sub>	V <sub>IN</sub> =1V <sub>rms</sub> , f=1kHz Volume=0dB	-0.5	0	0.5	dB
Voltage Gain Error	ΔG <sub>V</sub>	V <sub>IN</sub> =1V <sub>rms</sub> , f=1kHz Volume=0dB	-0.5	0	0.5	dB
Maximum Attenuation	A <sub>TT</sub>	f=1KHz, V <sub>IN</sub> =1V <sub>rms</sub> Volume=Mute	-	-110	-	dB
Attenuation Error	ΔA <sub>TT</sub>	f=1KHz, V <sub>IN</sub> =1V <sub>rms</sub> Volume=-60dB	-1	0	1	dB
Output Noise	V <sub>NO</sub>	Volume=0dB, Rg=0, A-weight	-	-110 (3.2μ)	-100 (10μ)	dBV (V <sub>rms</sub> )
Total Harmonic Distortion	T.H.D	f=1KHz, V <sub>o</sub> =1V <sub>rms</sub> , Volume=0dB	-	0.005	0.05	%
Channel Separation	CS	f=1KHz, V <sub>o</sub> =1V <sub>rms</sub> , A-weight Volume=0dB	-	-100	-90	dB

### ◆ Input/Output Characteristics (REC output)

REC Out Voltage Gain	G <sub>VREC</sub>	V <sub>IN</sub> =1V <sub>rms</sub> , f=1kHz	-0.5	0	0.5	dB
REC Out Total Harmonic Distortion	T.H.D <sub>REC</sub>	f=1KHz, V <sub>o</sub> =1V <sub>rms</sub> ,	-	0.005	0.05	%

### ◆ Input Selector Gain Control Characteristics

Input Selector Gain Control Voltage Gain 1	G <sub>VINC1</sub>	Input Selector Gain = 0dB	-0.5	0	+0.5	dB
Input Selector Gain Control Voltage Gain 2	G <sub>VINC2</sub>	Input Selector Gain = -6dB	-6.5	-6.0	-5.5	dB
Input Selector Gain Control Voltage Gain 3	G <sub>VINC3</sub>	Input Selector Gain = -12dB	-12.5	-12.0	-11.5	dB

## ■ ELECTRICAL CHARACTERISTICS (Ta=25°C, V<sup>+</sup>/V<sup>-</sup>=±7V)

PARAMETER	SYMBOL	TEST CONDITION	MIN.	TYP.	MAX.	UNIT
<b>◆Tone Control Characteristics</b>						
Treble Voltage Gain 1	G <sub>VTREB1</sub>	Vo=1Vrms, f=10KHz Volume=0dB Treble=0dB	-2.0	0	2.0	dB
Treble Voltage Gain 2	G <sub>VTREB2</sub>	Vo=1Vrms, f=10KHz Volume=0dB Treble=10dB	8.0	10.0	12.0	dB
Treble Voltage Gain 3	G <sub>VTREB3</sub>	Vo=1Vrms, f=10KHz Volume=0dB Treble=-10dB	-12.0	-10.0	-8.0	dB
Bass Voltage Gain 1	G <sub>VBASS1</sub>	Vo=1Vrms, f=100Hz Volume=0dB Bass=0dB	-2.0	0	2.0	dB
Bass Voltage Gain 2	G <sub>VBASS2</sub>	Vo=1Vrms, f=100Hz Volume=0dB Bass=10dB	8.0	10.0	12.0	dB
Bass Voltage Gain 3	G <sub>VBASS3</sub>	Vo=1Vrms, f=100Hz Volume=0dB Bass=-10dB	-12.0	-10.0	-8.0	dB
<b>◆Volume Output Gain Control Characteristics</b>						
Volume Output Gain Control Voltage Gain 1	G <sub>VOUTC1</sub>	Volume=0dB Volume Output Gain=3dB	2.0	3.0	4.0	dB
Volume Output Gain Control Voltage Gain 2	G <sub>VOUTC2</sub>	Volume =0dB Volume Output Gain =9dB	8.0	9.0	10.0	dB
Volume Output Gain Control Voltage Gain 3	G <sub>VOUTC3</sub>	Volume =0dB Volume Output Gain =18 dB	17.0	18.0	19.0	dB
<b>◆Logic Control Characteristics</b>						
High Level Input Voltage	V <sub>IH</sub>		2.9	-	5.5	V
Low Level Input Voltage	V <sub>IL</sub>		0	-	1.5	V

## ■ TERMINAL DESCRIPTION

PIN NO.	SYMBOL	FUNCTION	EQUIVALENT CIRCUIT	TERMINAL DC VOLTAGE
1 47	FIL2_R FIL2_L	Rch Bass filter terminal Lch Bass filter terminal		0
2 46	FIL3_R FIL3_L	Rch Bass filter DC cut capacitor output terminal Lch Bass filter DC cut capacitor output terminal		0
3 45	FIL4_R FIL4_L	Rch Bass filter DC cut capacitor input terminal Lch Bass filter DC cut capacitor input terminal		0
5 7 9 11 58 59 60 61 62 63	FL+ FR+ DCLA_1 DCRA_1 RECL1 RECR1 RECL2 RECR2 RECL3 RECR3	"Input Selector Gain Control" Lch Non Inverted Output "Input Selector Gain Control" Rch Non Inverted Output "Input selector" Lch output "Input selector" Rch output "Input selector" Lch REC output 1 "Input selector" Rch REC output 1 "Input selector" Lch REC output 2 "Input selector" Rch REC output 2 "Input selector" Lch REC output 3 "Input selector" Rch REC output 3		0

## ■ TERMINAL DESCRIPTION

PIN NO.	SYMBOL	FUNCTION	EQUIVALENT CIRCUIT	TERMINAL DC VOLTAGE
6 8	FL- FR-	"Input Selector Gain Control" Lch Inverted Output "Input Selector Gain Control" Rch Inverted Output		0
10 12 13 14 15 16 17 18 19 20 21 22 23 24 25 26 27 28	DCLA_2 DCRA_2 L1IN R1IN L2IN R2IN L3IN R3IN L4IN R4IN L5IN R5IN L6IN R6IN L7IN R7IN L8IN R8IN	"Multi Channel Selector" Lch Input "Multi Channel Selector" Rch Input "Input selector" Lch Input 1 "Input selector" Rch Input 1 "Input selector" Lch Input 2 "Input selector" Rch Input 2 "Input selector" Lch Input 3 "Input selector" Rch Input 3 "Input selector" Lch Input 4 "Input selector" Rch Input 4 "Input selector" Lch Input 5 "Input selector" Rch Input 5 "Input selector" Lch Input 6 "Input selector" Rch Input 6 "Input selector" Lch Input 7 "Input selector" Rch Input 7 "Input selector" Lch Input 8 "Input selector" Rch Input 8		0
29 30 31	DATA CLOCK LATCH	Control Data Signal Input Clock Signal Input Latch Signal Input		0

## ■ TERMINAL DESCRIPTION

PIN NO.	SYMBOL	FUNCTION	EQUIVALENT CIRCUIT	TERMINAL DC VOLTAGE
32 33 34 35 36 37 38 39 40 41 42 43	LAIN RAIN CAIN SLAIN SRAIN SWAIN LBIN RBIN CBIN SLBIN SRBIN SWBIN	Multi Channel Lch Input A Multi Channel Rch Input A Multi Channel Cch Input A Multi Channel SLch Input A Multi Channel SRch Input A Multi Channel SWch Input A Multi Channel Lch Input B Multi Channel Rch Input B Multi Channel Cch Input B Multi Channel SLch Input B Multi Channel SRch Input B Multi Channel SWch Input B		0
44	SurTC	Switching Noise Rejection Capacitor		V-
48 64	FIL1_L FIL1_R	Lch Treble Filter Terminal Rch Treble Filter Terminal		0
49 50	LOUT ROUT	Lch Output Rch Output		0

# NJW1153

## ■ TERMINAL DESCRIPTION

PIN NO.	SYMBOL	FUNCTION	EQUIVALENT CIRCUIT	TERMINAL DC VOLTAGE
51 52 53 54	COOUT SLOUT SROUT SWOUT	Cch Output SLch Output SRch Output SWch Output		0
55	V+	+Power Supply Voltage Input		V+
4 56	GND	Ground		0



## APPLICATION CIRCUIT

www.datasheet4u.com

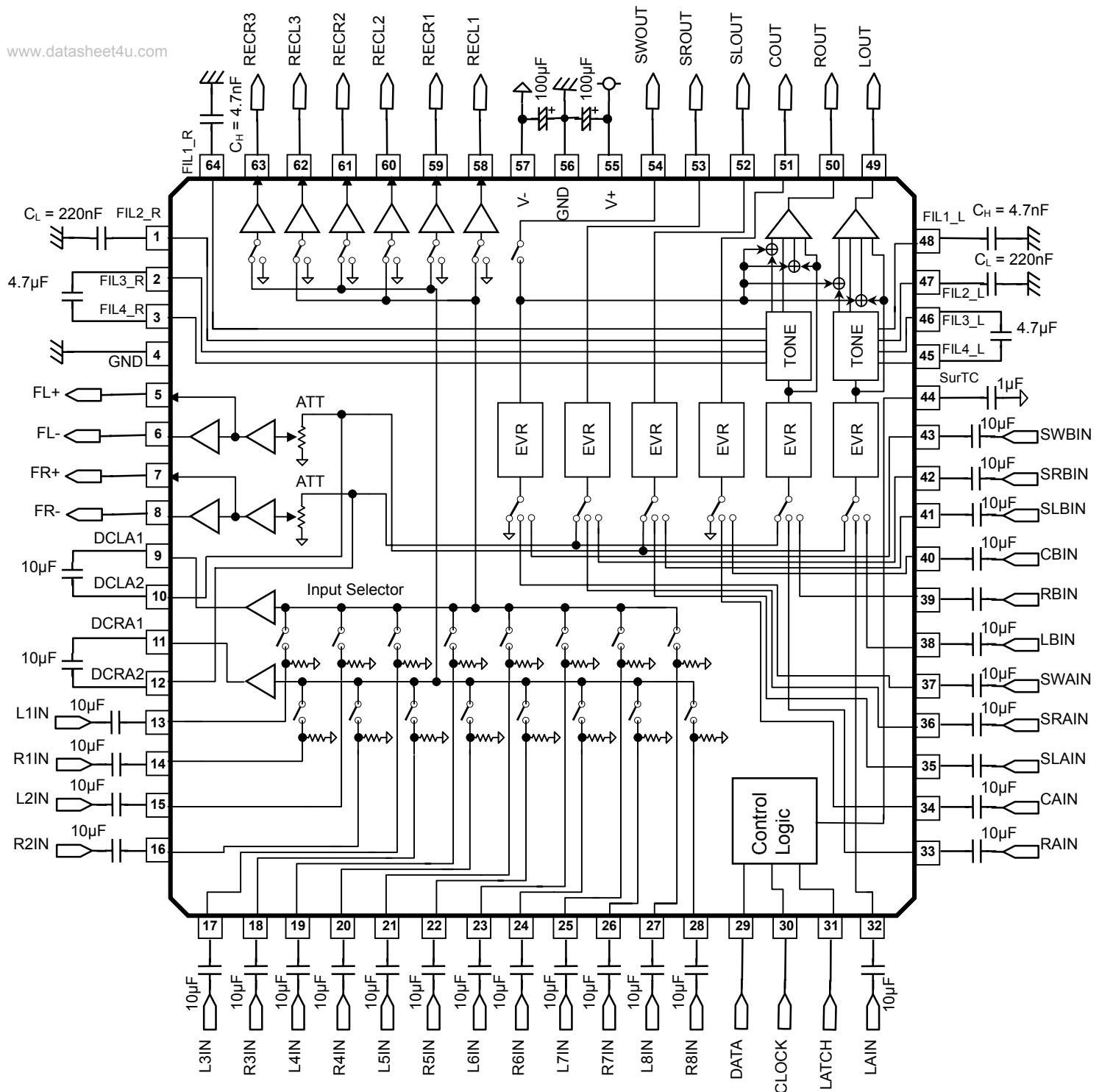

### < TONE filter setting >

TONE cut off frequency is adjusted by the external capacitors and given by the following functions.

$$\text{TREBLE ; } f_{c_H} = \frac{1}{2\pi \times 3.75k \times C_H} \text{ (Hz)}$$

$$\text{BASS ; } f_{c_L} = \frac{1}{2\pi \times 8k \times C_L} \text{ (Hz)}$$

## ■ CONTROL DATA FORMAT

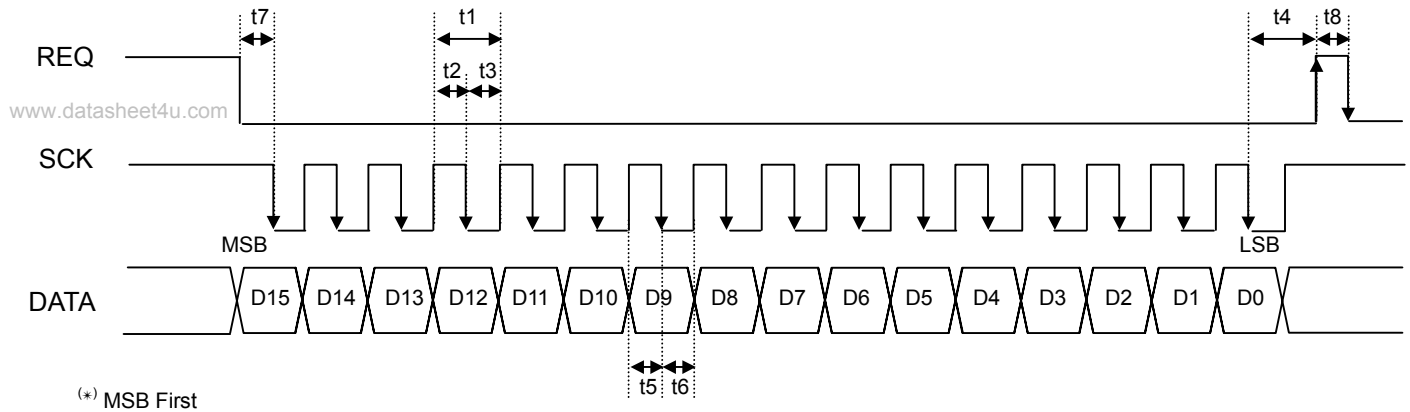

SYMBOL	PARAMETER	MIN	TYP	MAX	UNIT
t1	SCK Clock Width	2	-	-	μsec
t2	SCK Pulse Width (High)	0.8	-	-	μsec
t3	SCK Pulse Width (Low)	0.8	-	-	μsec
t4	REQ Rise Hold Time	1.6	-	-	μsec
t5	DATA Setup Time	0.8	-	-	μsec
t6	DATA Hold Time	0.8	-	-	μsec
t7	SCK Setup Time	0.8	-	-	μsec
t8	REQ High Pulse Width	1.6	-	-	μsec

## ■ CONTROL DATA

NJW1153 control data is constructed with 16bits.

MSB

LSB

D15	D14	D13	D12	D11	D10	D9	D8	D7	D6	D5	D4	D3	D2	D1	D0
Data								Select Address				Chip Address			

www.datasheet4u.com

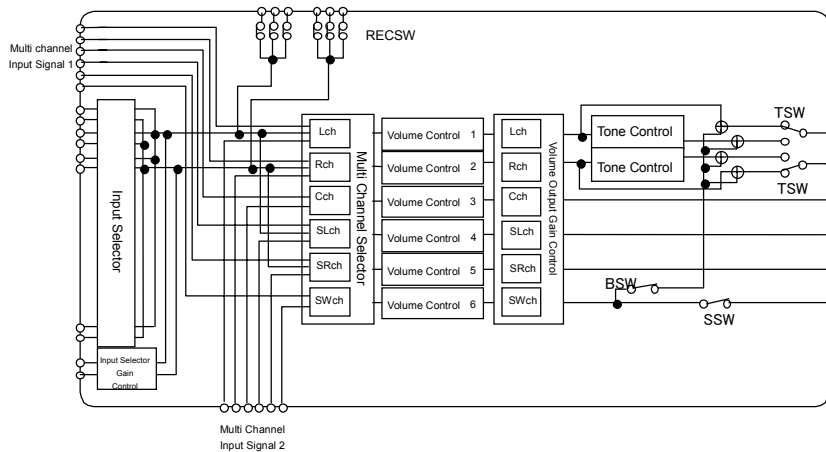

MSB

LSB

D15	D14	D13	D12	D11	D10	D9	D8	D7	D6	D5	D4	D3	D2	D1	D0
Volume Control 1							Don't Care	0	0	0	0	0	1	0	1
Volume Control 2							Don't Care	0	0	0	1	0	1	0	1
Volume Control 3							Don't Care	0	0	1	0	0	1	0	1
Volume Control 4							Don't Care	0	0	1	1	0	1	0	1
Volume Control 5							Don't Care	0	1	0	0	0	1	0	1
Volume Control 6							Don't Care	0	1	0	1	0	1	0	1
Input Selector Gain Control			Volume Output Gain Control			BSW	SSW	0	1	1	0	0	1	0	1
C/B	Tone Control Treble				TSW	Don't Care	Don't Care	0	1	1	1	0	1	0	1
C/B	Tone Control Bass				Don't Care	Don't Care	Don't Care	1	0	0	0	0	1	0	1
Input Selector			Multi Channel Selector		REC2	REC1	REC0	1	0	0	1	0	1	0	1

## ■ INITIAL CONDITION

MSB

LSB

D15	D14	D13	D12	D11	D10	D9	D8	D7	D6	D5	D4	D3	D2	D1	D0
1	1	1	1	1	1	1	1	0	0	0	0	0	1	0	1
1	1	1	1	1	1	1	1	0	0	0	1	0	1	0	1
1	1	1	1	1	1	1	1	0	0	1	0	0	1	0	1
1	1	1	1	1	1	1	1	0	0	1	1	0	1	0	1
1	1	1	1	1	1	1	1	0	1	0	0	0	1	0	1
1	1	1	1	1	1	1	1	0	1	0	1	0	1	0	1
0	0	0	0	0	0	0	0	0	1	1	0	0	1	0	1
0	0	0	0	0	0	0	0	0	1	1	1	0	1	0	1
0	0	0	0	0	0	0	0	1	0	0	0	0	1	0	1
0	0	0	0	0	0	0	0	1	0	0	1	0	1	0	1

## ■ DEFINITION OF RESISTOR

◆Volume Control 1 – 6 : 0dB to -100dB in 1dB/step.

D15	D14	D13	D12	D11	D10	D9	D8	D7	D6	D5	D4	D3	D2	D1	D0
Volume Control 1							Don't Care	0	0	0	0	0	1	0	1
Volume Control 2							Don't Care	0	0	0	1	0	1	0	1
Volume Control 3							Don't Care	0	0	1	0	0	1	0	1
Volume Control 4							Don't Care	0	0	1	1	0	1	0	1
Volume Control 5							Don't Care	0	1	0	0	0	1	0	1
Volume Control 6							Don't Care	0	1	0	1	0	1	0	1

< Volume Control 1 – 6 Data >

Data							Setting
D15	D14	D13	D12	D11	D10	D9	
0	0	0	0	0	0	0	0dB
0	0	0	0	0	0	1	-1dB
0	0	0	0	0	1	0	-2dB
0	0	0	0	0	1	1	-3dB
0	0	0	0	1	0	0	-4dB
0	0	0	0	1	0	1	-5dB
0	0	0	0	1	1	0	-6dB
0	0	0	0	1	1	1	-7dB
0	0	0	1	0	0	0	-8dB
0	0	0	1	0	0	1	-9dB
0	0	0	1	0	1	0	-10dB
0	0	0	1	0	1	1	-11dB
0	0	0	1	1	0	0	-12dB
0	0	0	1	1	0	1	-13dB
0	0	0	1	1	1	0	-14dB
0	0	0	1	1	1	1	-15dB
0	0	1	0	0	0	0	-16dB
0	0	1	0	0	0	1	-17dB
0	0	1	0	0	1	0	-18dB
0	0	1	0	0	1	1	-19dB
0	0	1	0	1	0	0	-20dB
0	0	1	0	1	0	1	-21dB
0	0	1	0	1	1	0	-22dB
0	0	1	0	1	1	1	-23dB
0	0	1	1	0	0	0	-24dB
0	0	1	1	0	0	1	-25dB
...							...
1	1	0	0	0	0	1	-97dB
1	1	0	0	0	1	0	-98dB
1	1	0	0	0	1	1	-99dB
1	1	0	0	1	0	0	-100dB
1	1	1	1	1	1	1	MUTE <sup>(*)</sup>

(\*)Initial Setting

◆ **Input Selector Gain Control:** Adjust the gain of selected signal at the Input Selector.

**Volume Output Gain Control** : Adjust the gain of volume output.

**BSW** : Add the SW channel output to the L/R channel output.

**SSW** : Select the SW output ON/OFF.

D15	D14	D13	D12	D11	D10	D9	D8	D7	D6	D5	D4	D3	D2	D1	D0
Input Selector Gain Control			Volume Output Gain Control			BSW	SSW	0	1	1	0	0	1	0	1

< Input Selector Gain Control Data >

Data			Setting
D15	D14	D13	
0	0	0	0dB <sup>(*)</sup>
0	0	1	-3dB
0	1	0	-6dB
0	1	1	-9dB
1	0	0	-12dB

< Volume Output Gain Control Data >

Data			Setting
D12	D11	D10	
0	0	0	0dB <sup>(*)</sup>
0	0	1	+3dB
0	1	0	+6dB
0	1	1	+9dB
1	0	0	+12dB
1	0	1	+15dB
1	1	0	+18dB

Note; Fix the volume output gain in your application to avoid switching noise.

< BSW : SWch Output add to L/Rch Output >

D9	Setting
0	OFF <sup>(*)</sup>
1	Add

< SSW : SW Output ON/OFF >

D8	Setting
0	SW Output ON <sup>(*)</sup>
1	SW Output OFF

<sup>(\*)</sup>Initial Setting

- ◆C/B : Set the treble cut or boost of the tone control.
- Tone Control Treble** : Set the treble gain of the tone control.
- TSW** : Select by-pass or effect of the tone control.

D15	D14	D13	D12	D11	D10	D9	D8	D7	D6	D5	D4	D3	D2	D1	D0
C/B	Tone Control Treble				TSW	Don't Care	Don't Care	0	1	1	1	0	1	0	1

< C/B : Treble Cut / Boost >

D15	Setting
0	Cut <sup>(*)</sup>
1	Boost

< Tone Control Treble : Treble Gain >

Data				Cut	Boost
D14	D13	D12	D11		
0	0	0	0	0dB <sup>(*)</sup>	0dB
0	0	0	1	-1dB	1dB
0	0	1	0	-2dB	2dB
0	0	1	1	-3dB	3dB
0	1	0	0	-4dB	4dB
0	1	0	1	-5dB	5dB
0	1	1	0	-6dB	6dB
0	1	1	1	-7dB	7dB
1	0	0	0	-8dB	8dB
1	0	0	1	-9dB	9dB
1	0	1	0	-10dB	10dB

< Tone Control By-pass Switch >

D10	Setting
0	Tone Control OFF <sup>(*)</sup>
1	Tone Control ON

<sup>(\*)</sup>Initial Setting

- ◆C/B : Set the bass cut or boost of the tone control.
- Tone Control Bass** : Set the bass gain of the tone control.

D15	D14	D13	D12	D11	D10	D9	D8	D7	D6	D5	D4	D3	D2	D1	D0
C/B	Tone Control Bass				Don't Care	Don't Care	Don't Care	1	0	0	0	0	1	0	1

< C/B : Bass Cut / Boost >

D15	Setting
0	Cut <sup>(*)</sup>
1	Boost

<Tone Control Bass : Bass Gain >

Data				Cut	Boost
D14	D13	D12	D11		
0	0	0	0	0dB <sup>(*)</sup>	0dB
0	0	0	1	-1dB	1dB
0	0	1	0	-2dB	2dB
0	0	1	1	-3dB	3dB
0	1	0	0	-4dB	4dB
0	1	0	1	-5dB	5dB
0	1	1	0	-6dB	6dB
0	1	1	1	-7dB	7dB
1	0	0	0	-8dB	8dB
1	0	0	1	-9dB	9dB
1	0	1	0	-10dB	10dB

<sup>(\*)</sup>Initial Setting

- ◆ **Input Selector** : Select the stereo inputs.
- ◆ **Multi Channel Selector** : Select the 2ch Input signal, multi channel input signal A, or multi channel input signal B.
- ◆ **REC2/REC1/REC0** : Switch the 3 REC outputs.

D15	D14	D13	D12	D11	D10	D9	D8	D7	D6	D5	D4	D3	D2	D1	D0
Input Selector			Multi Channel Selector		REC2	REC1	REC0	1	0	0	1	0	1	0	1

< Input Selector >

Data			Setting
D15	D14	D13	
0	0	0	Input1 <sup>(*)</sup>
0	0	1	Input2
0	1	0	Input3
0	1	1	Input4
1	0	0	Input5
1	0	1	Input6
1	1	0	Input7
1	1	1	Input8

< Multi Channel Selector >

Data		Setting
D12	D11	
0	0	Input Selector Output Signal <sup>(*)</sup>
0	1	Multi channel Input Signal A
1	0	Multi channel Input Signal B

In "Input Selector Output Signal" setting, the SLch and SRch output the signal same as the Lch and Rch, and the Cch and SWch output are set mute condition.

< REC2,REC1,REC0 ON/OFF >

Data		Setting
D10 - D8		
0		REC Output 2 - 0 OFF <sup>(*)</sup>
1		REC Output 2 - 0 ON

<sup>(\*)</sup>Initial Setting

## TYPICAL CHARACTERISTICS

Operating Current vs. Power Supply Vpitage  
Ta=25°C

www.datasheet4u.com

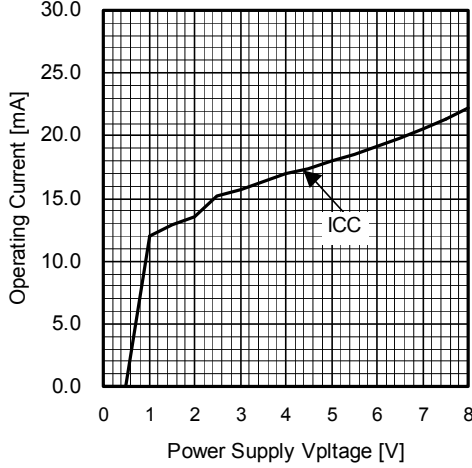

Operating Current vs. Power Supply Vpitage  
Ta=25°C

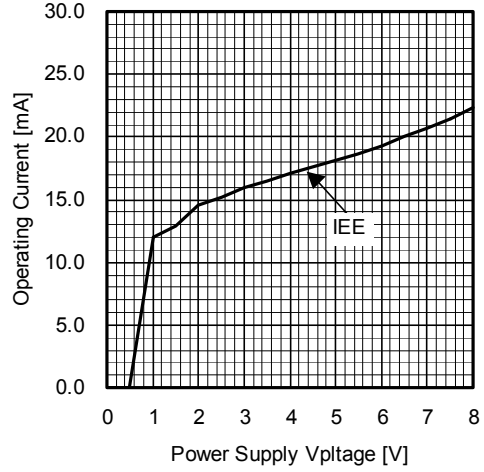

Voltage Gain vs. Attenuator Set Level  
V+=7V V-=-7V Vin=0dBV f=1kHz RL=10kΩ Ta=25°C

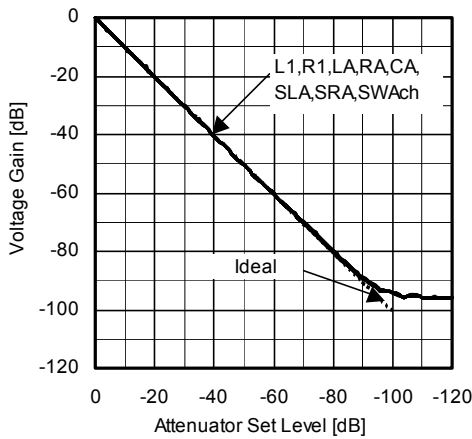

Voltage Gain vs. Output Gain Set Level  
V+=7V V-=-7V Vin=0dBV f=1kHz RL=10kΩ Ta=25°C

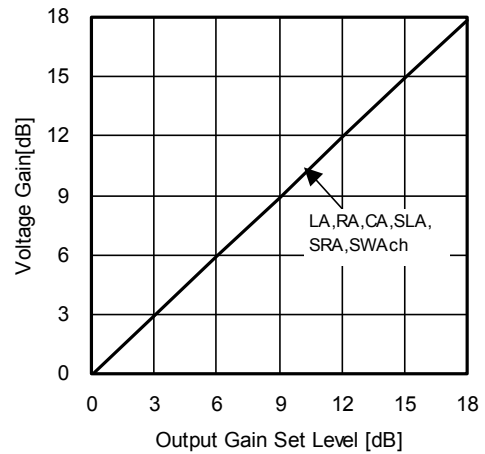

Input Selector Output Gain vs. Gain Set Level  
V+=7V V-=-7V Vin=0dBV f=1kHz RL=10kΩ Ta=25°C

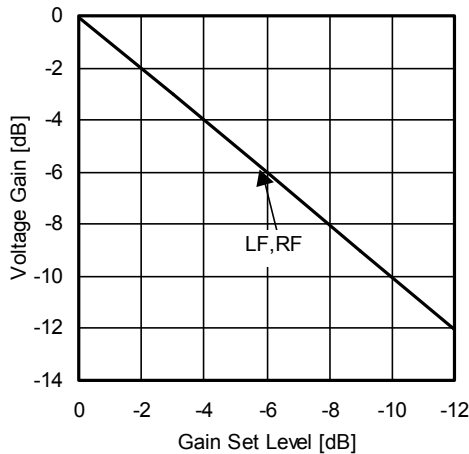

Tone Control Output Level vs. Frequency  
V+=7V V-=-7V Vin=0dBV RL=10kΩ, LAch. Ta=25°C

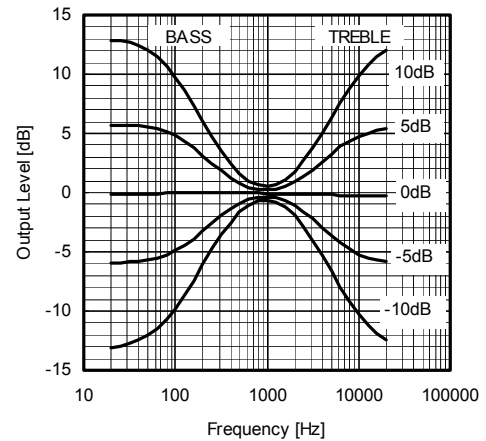



## TYPICAL CHARACTERISTICS

www.datasheet4u.com

Volume THD+N vs. Input Level  
 INPUT:LAIN OUTPUT:L.OUT  
 V+=7V V-=-7V RL=10kΩ 0dB setting  
 BW=10Hz-80kHz Ta=25°C

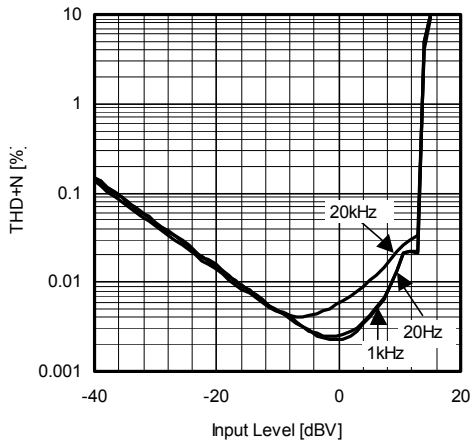

Volume THD+N vs. Input Level  
 INPUT:LAIN OUTPUT:L.OUT f=1kHz  
 V+=7V V-=-7V BW=10Hz-80kHz Ta=25°C

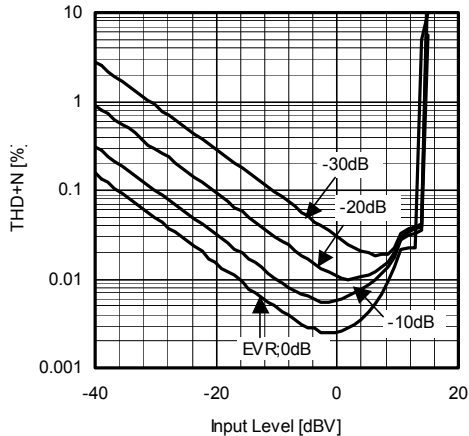

Volume THD+N vs. Input Level  
 INPUT:L1IN OUTPUT:REC1L  
 V+=7V V-=-7V RL=10kΩ BW=10Hz-80kHz Ta=25°C

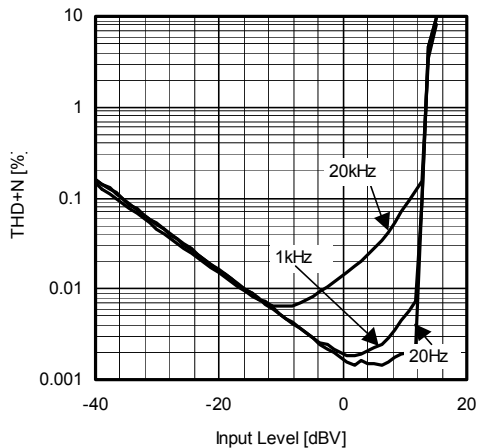

Volume THD+N vs. Input Level  
 INPUT:LAIN OUTPUT:L.OUT  
 TONEon BW=10Hz-80kHz Ta=25°C

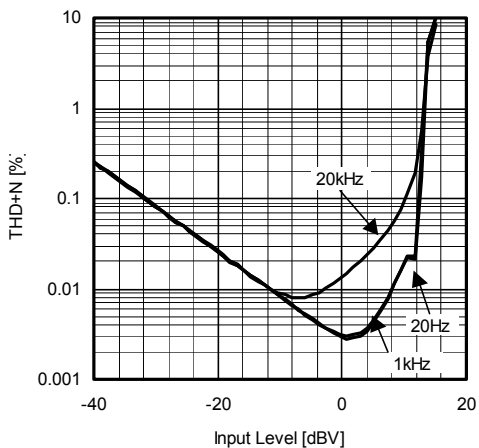

Operating Current vs. Ambient Temperature  
 ICC V+=7V V-=-7V

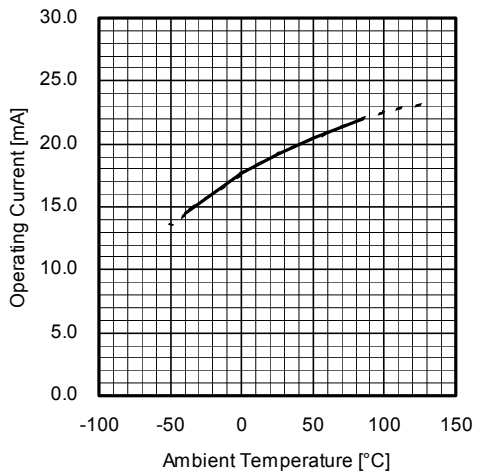

Operating Current vs. Ambient Temperature  
 IEE V+=7V V-=-7V

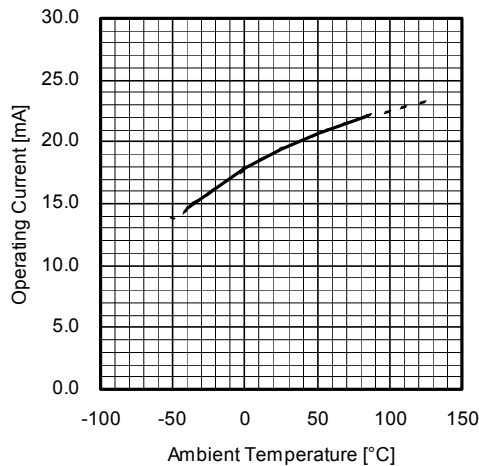

## TYPICAL CHARACTERISTICS

www.datasheet4u.com

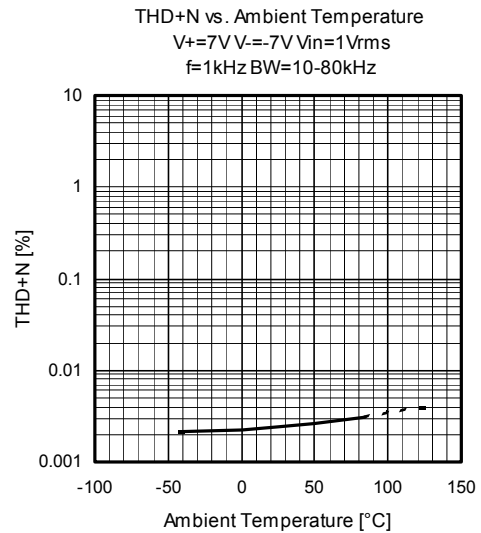
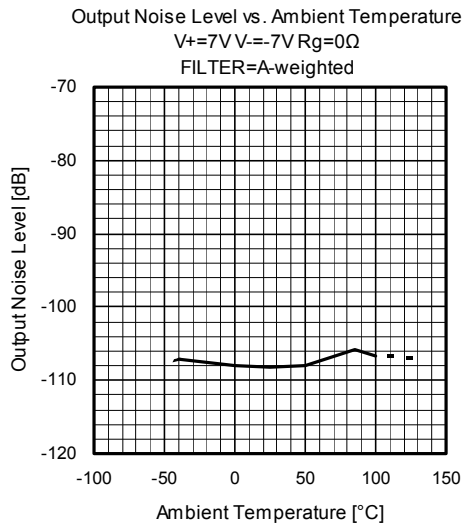
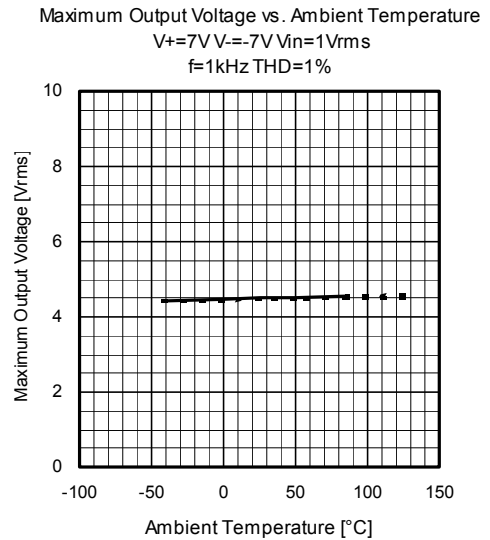
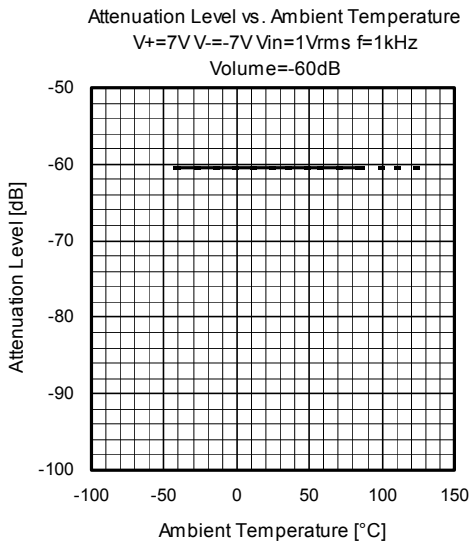
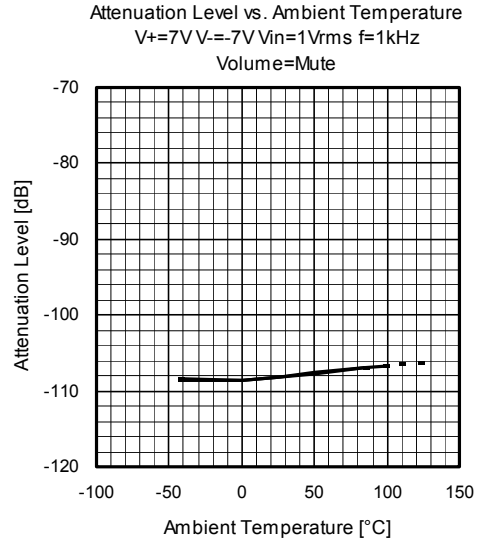
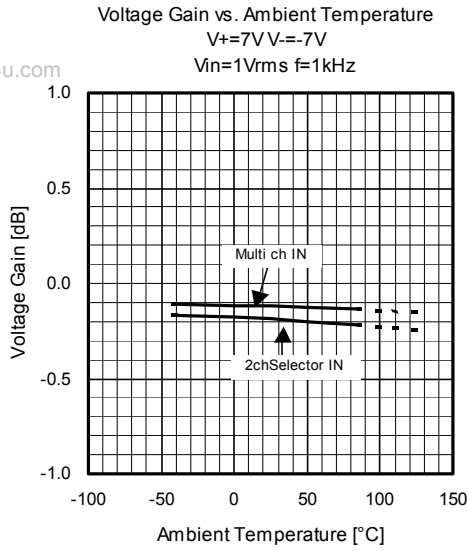

## TYPICAL CHARACTERISTICS

www.datasheet4u.com

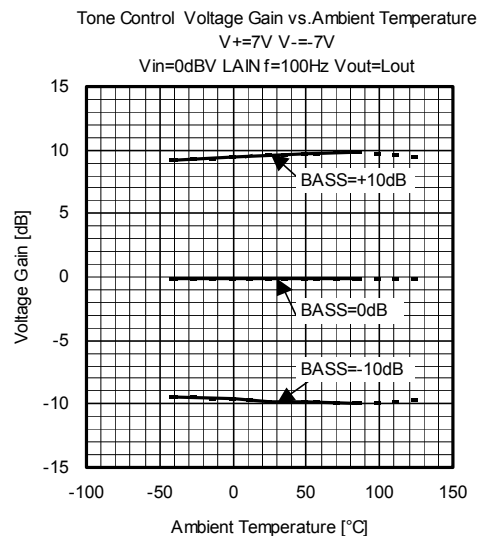
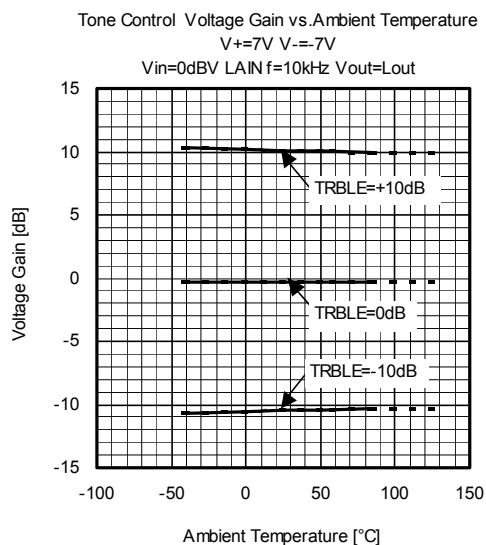
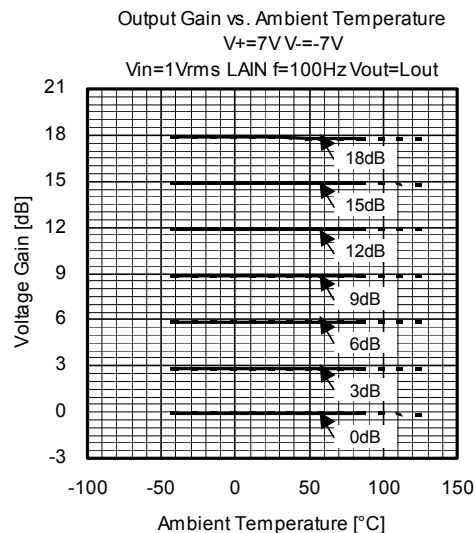
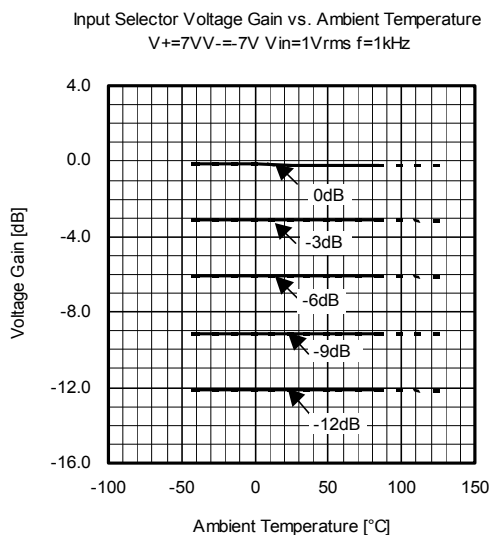
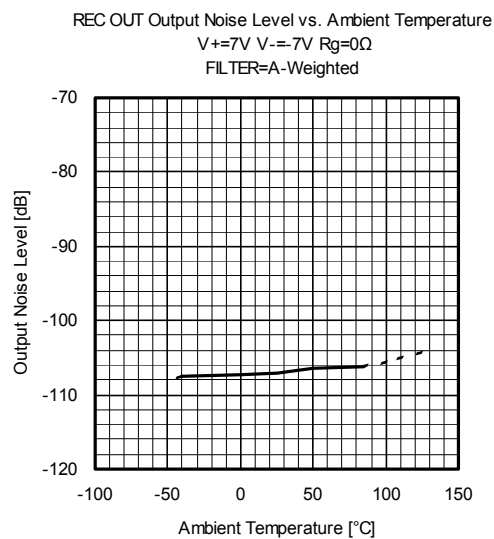
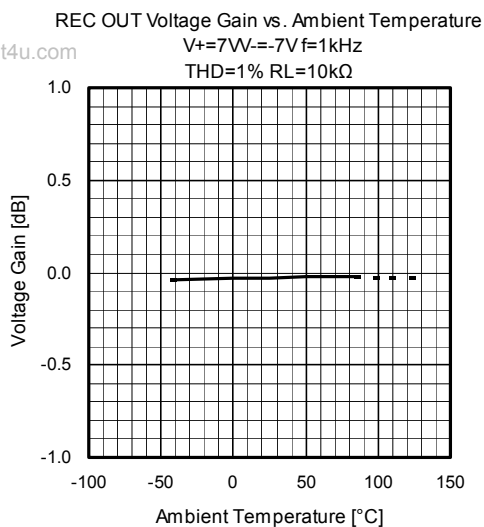

[CAUTION]  
The specifications on this databook are only given for information, without any guarantee as regards either mistakes or omissions. The application circuits in this databook are described only to show representative usages of the product and not intended for the guarantee or permission of any right including the industrial rights.