



## AUDIO PROCESSOR with BBE

www.datasheet4u.com

### ■ GENERAL DESCRIPTION

The **NJW1164** is a TV audio processor with sound enhancement (BBE).

The **NJW1164** contains all necessary functions to process TV audio signal such as volume control, tone control, balance, mute, AGC and NJRC's proprietary surround sound process, eala. The eala reproduces a natural surround sound with clear vocal orientation.

The total modes and variables are controlled by the I<sup>2</sup>C bus interface.

### ■ PACKAGE OUTLINE

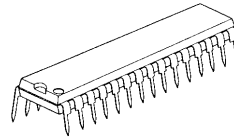

NJW1164L

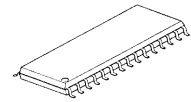

NJW1164M

### ■ FEATURES

- Operating Voltage            7.5 to 13V
- I<sup>2</sup>C BUS Interface
- BBE Sound Enhancement (Low Boost and High Boost: 15dB max.)
- eala (NJRC Original Surround)
- AGC Circuit (It reduces volume difference among input sources.)
- Simulated Surround
- Bi-CMOS Technology
- Package Outline            SDIP30, SDMP30

### ■ BLOCK DIAGRAM

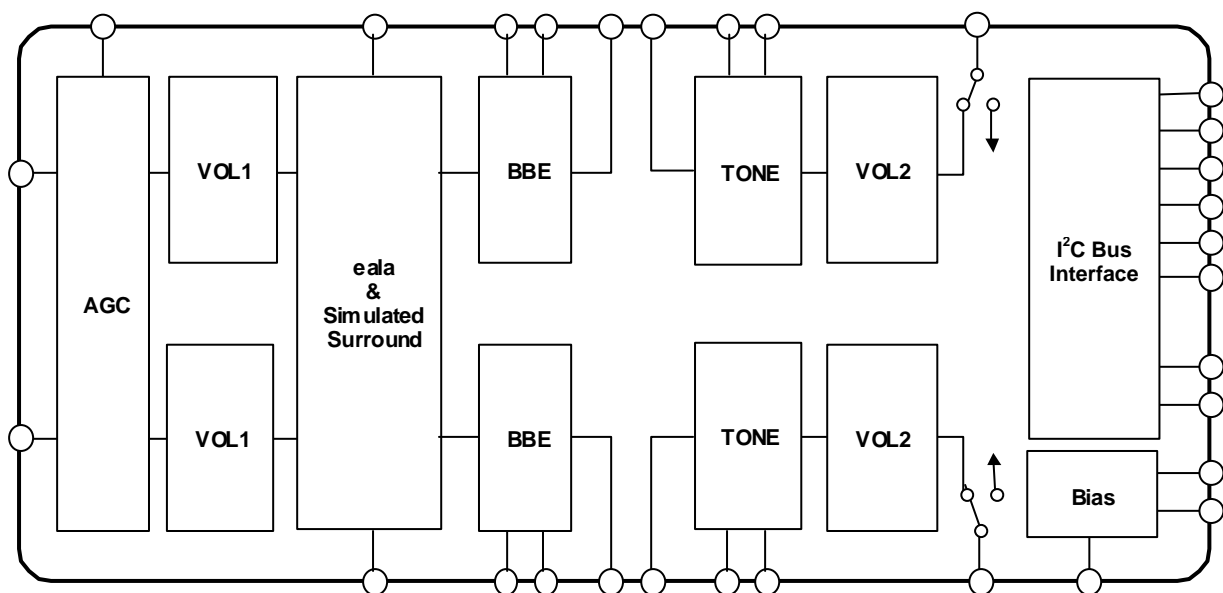

■ PIN FUNCTION

www.datasheet4u.com

1	INa	INb	30
2	BBE1a	BBE1b	29
3	BBE2a	BBE2b	28
4	BBEOUTa	BBEOUTb	27
5	TONE INa	TONE INb	26
6	TONE-Ha	TONE-Hb	25
7	TONE-La	TONE-Lb	24
8	OUTa	OUTb	23
9	AGC	SR-FIL	22
10	SS-FIL	VREF	21
11	CVB	CTH	20
12	CVA	CTL	19
13	SDA	AUX0	18
14	SCL	AUX1	17
15	GND	Vcc	16

No.	Symbol	Function	No	Symbol	Function
1	INa	Ach Input	16	Vcc	Power Supply Pin
2	BBE1a	Ach BBE Filter1 (Process)	17	AUX1	Auxiliary Output1
3	BBE2a	Ach BBE Filter2 (Lo Contour)	18	AUX0	Auxiliary Output0
4	BBE OUTa	Ach Output for the Other Accessories	19	CTL	Pop Noise reduction for Bass Control
5	TONE INa	Ach Input From the Other Accessories	20	CTH	Pop Noise reduction for Treble Control
6	TONE-Ha	Ach Treble Filter	21	VREF	Reference Voltage
7	TONE-La	Ach Bass Filter	22	SR-FIL	Surround Filter
8	OUTa	Ach Output	23	OUTb	Bch Output
9	AGC	AGC Filter	24	TONE-Lb	Bch Bass Filter
10	SS-FIL	Simulated Stereo Filter	25	TONE-Hb	Bch Treble Filter
11	CVB	Pop Noise Reduction for Volume & Balance	26	TONE INb	Bch Input from the Other Accessories
12	CVA	Pop Noise Reduction for Volume & Balance	27	BBE OUTb	Bch Output for the Other Accessories
13	SDA	SDA Data Input (I <sup>2</sup> C BUS)	28	BBE2b	Bch BBE Filter2 (Process)
14	SCL	SCL Data Input (I <sup>2</sup> C BUS)	29	BBE1b	Bch BBE Filter1 (Lo Contour)
15	GND	GND	30	INb	Bch Input

■ **ABSOLUTE MAXIMUM RATING** (Ta=25°C)

PARAMETER	SYMBOL	RATING	UNIT
Supply Voltage	V <sup>+</sup>	15	V
Power Dissipation	P <sub>D</sub>	700	mW
Operating Temperature Range	T <sub>opr</sub>	-20 to +75	°C
Storage Temperature Range	T <sub>stg</sub>	-40 to +125	°C

■ **ELECTRICAL CHARACTERISTICS**

(Ta=25°C, V+=9V, Rg=600Ω, RL=47kΩ, Vin=100mVrms/1kHz unless otherwise specified)

PARAMETER	SYMBOL	TEST CONDITION	MIN.	TYP.	MAX.	UNIT
Operating Voltage	V <sup>+</sup>		7.5	9.0	13.0	V
Supply Current	I <sub>CC</sub>	No Signal	-	13	25	mA
Reference Voltage	V <sub>REF</sub>	No Signal	4.0	4.5	5.0	V
Maximum Input Voltage	V <sub>IM</sub>	VOL=-20dB, THD=1%	2.8	3.0	-	Vrms
Maximum Output Voltage	V <sub>OM</sub>	OUTPUT VOL=0dB, THD=1%	-	2.5	-	Vrms
Channel Balance	G <sub>CB</sub>	VOL=0dB	-1.5	0.0	1.5	dB
Balance Boost A	BA <sub>BST</sub>	CHS="0", BAL="11111"	-2.0	0.0	2.0	dB
Balance Cut A	BA <sub>CUT</sub>	CHS="1", BAL="11111" Vin = 1Vrms	-	-	-70	dB
Balance Boost B	BB <sub>BST</sub>	CHS="1", BAL="11111"	-2.0	0.0	2.0	dB
Balance Cut B	BB <sub>CUT</sub>	CHS="0", BAL="11111" Vin = 1Vrms	-	-	-70	dB
Total Harmonic Distortion	THD	Vo=0.5Vrms BW=400Hz to 30kHz	-	-	0.5	%
Maximum Gain	G <sub>VMAX</sub>	VOL= 0dB	-2.0	0.0	2.0	dB
Minimum Gain	G <sub>VMIN</sub>	VOL= MUTE	-	-	-70	dB
Channel Separation	CS	Vin = 2Vrms Ain → Bout, Bin → Aout	-	-	-70	dB
Output Noise 1	V <sub>NO1</sub>	VOL = 0dB BW=400Hz to 30kHz	-	-90 (31.6)	-85 (56.2)	dBV (μVrms)
Output Noise 2	V <sub>NO2</sub>	VOL = MUTE BW = 400Hz to 30kHz	-	-106 (5.0)	-96 (15.8)	dBV (μVrms)
AUX Output Voltage	V <sub>AUX</sub>	Logic Output: High	4.5	-	5.0	V
		Logic Output: Low	0	-	0.3	

BW: Band Width

◆ TONE CONTROL

PARAMETER	SYMBOL	TEST CONDITION	MIN.	TYP.	MAX.	UNIT
High Frequency Boost	HF <sub>BST</sub>	BCT="1", TREB="1111", f=10kHz	12.5	15.0	17.5	dB
High Frequency Flat	HF <sub>FLT</sub>	TRBE="0000", f=10kHz	-2.0	0.0	2.0	dB
High Frequency Cut	HF <sub>CUT</sub>	BCT="0", TRBE="1111", f=10kHz	-17.5	-15.0	-12.5	dB
Low Frequency Boost	LF <sub>BST</sub>	BCB="1", BASS="1111", f=100Hz	12.5	15.0	17.5	dB
Low Frequency Flat	LF <sub>FLT</sub>	BASS="0000", f=100Hz	-2.0	0.0	2.0	dB
Low Frequency Cut	LF <sub>CUT</sub>	BCB="0", BASS="1111", f=100Hz	-17.5	-15.0	-12.5	dB

◆ SUB-TONE CONTROL

PARAMETER	SYMBOL	TEST CONDITION	MIN.	TYP.	MAX.	UNIT
High Frequency Boost	SHF <sub>BST</sub>	BCST="1", SUB-TREB="11", f=10kHz	2.0	3.0	4.0	dB
High Frequency Cut	SHF <sub>CUT</sub>	BCST="0", SUB-TREB="11", f=10kHz	-4.0	-3.0	-2.0	dB
Low Frequency Boost	SLF <sub>BST</sub>	BCSB="1", SUB-BASS="11", f=100Hz	2.0	3.0	4.0	dB
Low Frequency Cut	SLF <sub>CUT</sub>	BCSB="0", SUB-BASS="11", f=100Hz	-4.0	-3.0	-2.0	dB

◆ AGC CONTROL

PARAMETER	SYMBOL	TEST CONDITION	MIN.	TYP.	MAX.	UNIT
AGC Boost	AGC <sub>BST</sub>	Vin=50mVrms, f=1kHz	1.5	3.5	5.5	dB
AGC Flat1	AGC <sub>FLT1</sub>	Vin=150mVrms, f=1kHz	-2.5	0.0	2.5	dB
AGC Flat2	AGC <sub>FLT2</sub>	Vin=300mVrms, f=1kHz	-2.5	0.0	2.5	dB
AGC Flat3	AGC <sub>FLT3</sub>	Vin=400mVrms, f=1kHz	-2.5	0.0	2.5	dB
AGC Flat4	AGC <sub>FLT4</sub>	Vin=540mVrms, f=1kHz	-2.5	0.0	2.5	dB
AGC Cut	AGC <sub>CUT</sub>	Vin=2Vrms, f=1kHz	-14	-10	-6.0	dB

◆ BBE

PARAMETER	SYMBOL	TEST CONDITION	MIN.	TYP.	MAX.	UNIT
BBE Low Frequency Boost Range	BBE <sub>LOW</sub>	BBE-Low="1111", f = 50Hz	-	15.0	-	dB
BBE High Frequency Boost Range	BBE <sub>HIGH</sub>	BBE-High="1111", f = 10KHz	-	15.0	-	dB

◆ SURROUND (SURROUND-ON)

PARAMETER	SYMBOL	TEST CONDITION	MIN.	TYP.	MAX.	UNIT
Surround Gain1	SR <sub>GAIN1</sub>	Ain→Aout, f=100Hz SUR0="0", SUR="1"	6.0	8.0	10.0	dB
Surround Gain2	SR <sub>GAIN2</sub>	Ain→Bout, f=100Hz SUR0="0", SUR="1"	1.6	3.6	5.6	dB
Surround Gain3	SR <sub>GAIN3</sub>	Ain→Aout, f=100Hz SUR0="1", SUR="1"	10.7	12.7	14.7	dB
Surround Gain4	SR <sub>GAIN 4</sub>	Ain→Bout, f=100Hz SUR0="1", SUR="1"	8.4	10.4	12.4	dB
Simulated Surround Gain1	SR <sub>SIM1</sub>	Ain+Bin→Aout, f=1kHz SUR0="1", SUR="0"	1.0	3.0	5.0	dB
Simulated Surround Gain2	SR <sub>SIM2</sub>	Ain+Bin→Bout, f=1kHz SUR0="1", SUR="0"	1.0	3.0	5.0	dB

**■ I<sup>2</sup>C BUS BLOCK CHARACTERISTICS (SDA, SCL)**

PARAMETER	SYMBOL	MIN.	TYP.	MAX.	UNIT
High Level Input Voltage	$V_{IH}$	2.5	-	5.0	V
Low Level Input Voltage	$V_{IL}$	0	-	1.5	V
High Level Input Current	$I_{IH}$	-	-	10	$\mu A$
Low Level Input Current	$I_{IL}$	-	-	10	$\mu A$
Low Level Output Voltage (3mA at SDA pin)	$V_{OL}$	0	-	0.4	V
Maximum Output Current	$I_{OL}$	-3.0	-	-	mA
Maximum Clock Frequency	$f_{SCL}$	-	-	100	kHz
Data Change Minimum Waiting Time	$t_{BUF}$	4.7	-	-	$\mu s$
Data Transfer Start Minimum Waiting Time	$t_{HD:STA}$	4.0	-	-	$\mu s$
Low Level Clock Pulse Width	$t_{LOW}$	4.7	-	-	$\mu s$
High Level Clock Pulse Width	$T_{HIGH}$	4.0	-	-	$\mu s$
Minimum Start Preparation Waiting Time	$t_{SU:STA}$	4.7	-	-	$\mu s$
Minimum Data Hold Time	$t_{HD:DAT}$	5.0	-	-	$\mu s$
Minimum Data Preparation Time	$t_{SU:DAT}$	250	-	-	ns
Rise Time	$t_R$	-	-	1.0	$\mu s$
Fall Time	$t_F$	-	-	300	ns
Minimum Stop Preparation Waiting Time	$t_{SU:STO}$	4.0	-	-	$\mu s$

I<sup>2</sup>C BUS Load Condition: Pull up resistance 4k $\Omega$  (Connected to +5V)  
Load capacitance 200pF (Connected to GND)

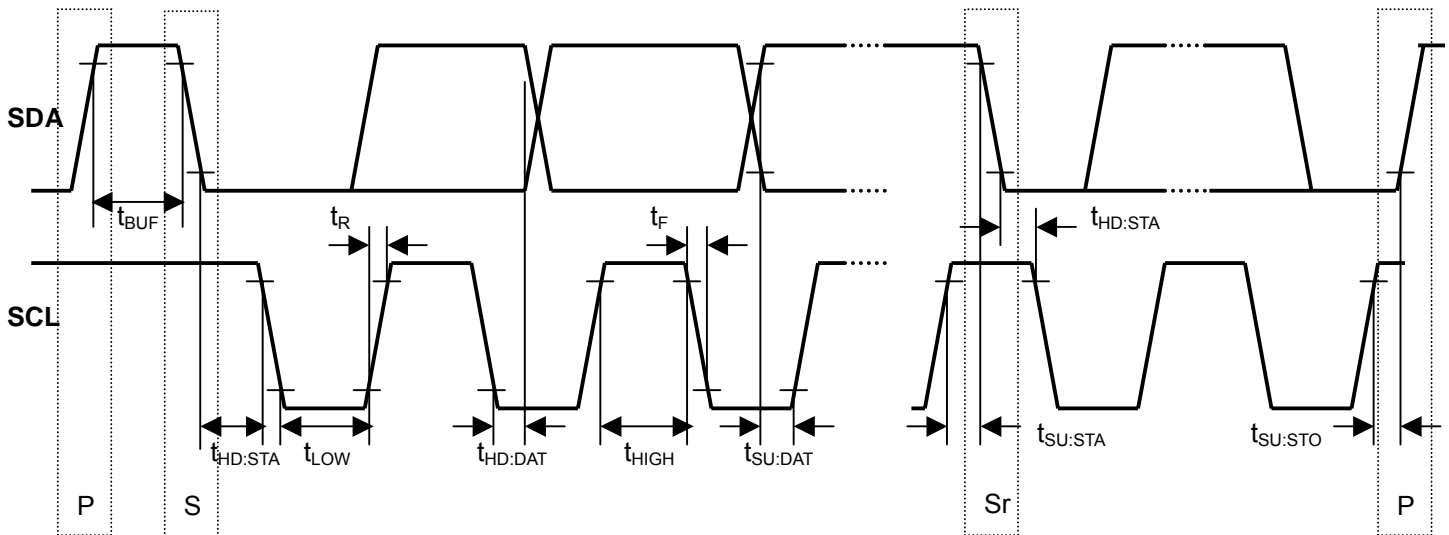

■TERMINAL DESCRIPTION

No.	SYMBOL	FUNCTION	EQUIVALENT CIRCUIT	VOLTAGE
1 30	INa INb	Ach Input terminal Bch Input terminal		V+/2
4 8 23 27	BBE OUTa OUTa OUTb BBE OUTb	Ach Output for the Other Accessories Ach Output Bch Output Bch Output for the Other Accessories		V+/2
10	SS-FIL	Simulated Stereo Filter terminal		V+/2
2 3 28 29	BBE1a BBE2a BBE2b BBE1b	Ach BBE Filter1 (Process) Ach BBE Filter2 (Lo Contour) Bch BBE Filter2 (Lo Contour) Bch BBE Filter1 (Process)		V+/2
6 25	TONE-Ha TONE-Hb	Treble (tone control) filter terminal		V+/2

www.datasheet4u.com

■ **TERMINAL DESCRIPTION**

No.	SYMBOL	FUNCTION	EQUIVALENT CIRCUIT	VOLTAGE
7 24	TONE-La TONE-Lb	Bass (tone control) filter terminal		V+/2
9	AGC	Capacitor connection terminal for AGC attack and recovery time setting		-
11 12	CVB CVA	Pop Noise Reduction for Volume & Balance		-
13	SDA	I <sup>2</sup> C data terminal		-
14	SCL	I <sup>2</sup> C clock terminal		-

■ TERMINAL DESCRIPTION

No.	SYMBOL	FUNCTION	EQUIVALENT CIRCUIT	VOLTAGE
5 26	TONE INa TONE INb	Ach Input from the Other Accessories Bch Input from the Other Accessories		V+/2
21	Vref	Reference voltage terminal		V+/2
17 18	AUX0 AUX1	Auxiliary 2 values voltage output terminal		0/5V
20 19	CTH CTL	Pop Noise reduction for Bass Control Pop Noise reduction for Treble Control		-
22	SR-FIL	Surround filter terminal		V+/2
15 16	V+ GND	Ground terminal Supply voltage terminal	-	-

www.datasheet4u.com



APPLICATION CIRCUIT

www.datasheet4u.com

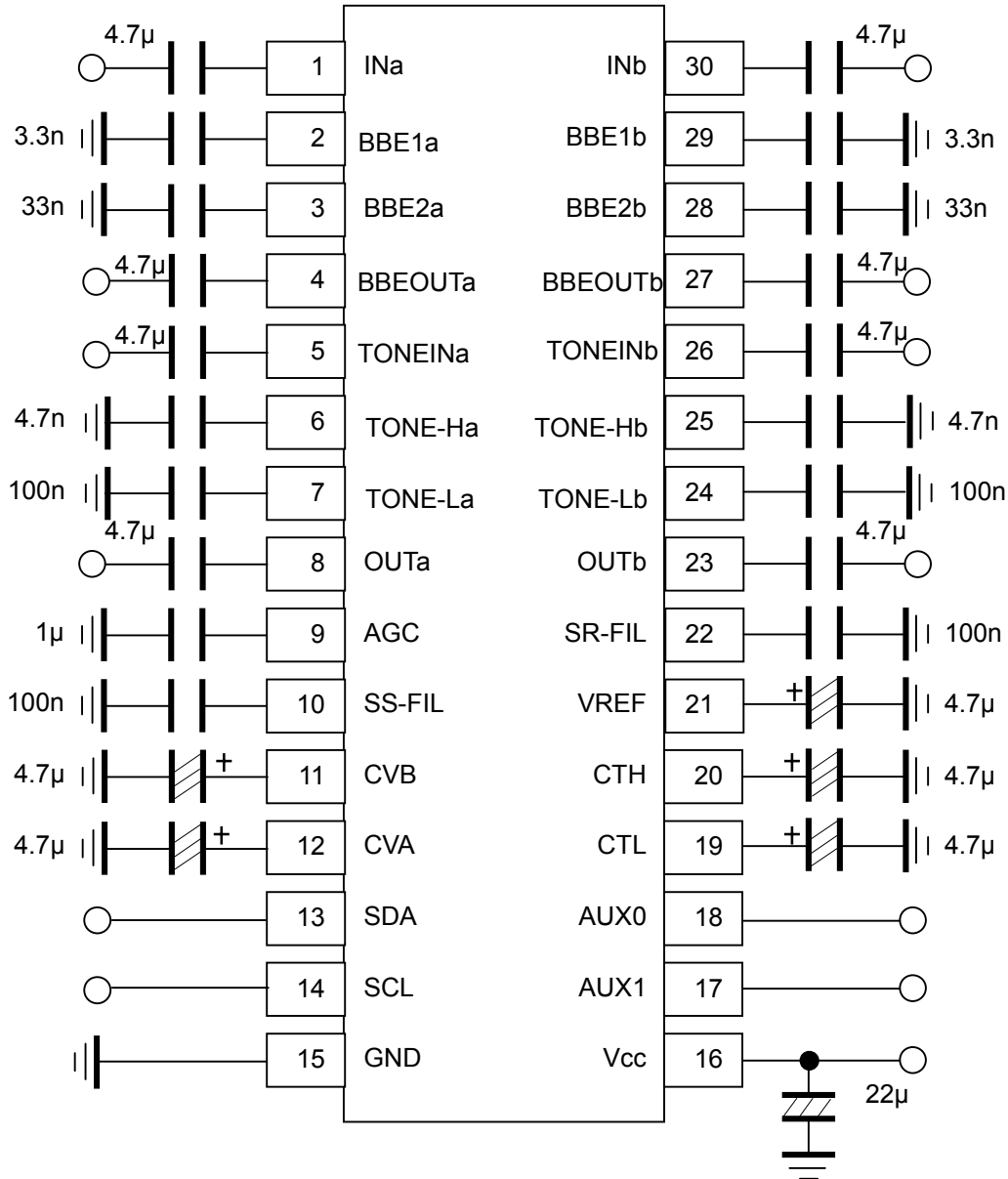

(NOTE)

1. Separate the I<sup>2</sup>C bus line from the following terminals for avoiding digital noise problem.

Pin No.	Symbol	Pin No.	Symbol	Pin No.	Symbol	Pin No.	Symbol	Pin No.	Symbol
2	BBE1a	6	TONE-Ha	10	SS FIL	24	TONE-Lb	28	BBE2b
3	BBE2a	7	TONE-La	22	SR FIL	25	TONE-Hb	29	BBE1b

2. The constant of capacitors connected to the terminals No.2, 3, 28 and 29 are designated by BBE Sound Inc. Do not change the constant of these capacitors without the approval of BBE Sound Inc.

■ APPLICATION NOTE

1. AGC (Auto Gain Control) Circuit

AGC circuit adjusts the input signal level with Boost/Attenuate circuit. AGC boost the low input signal level and attenuate high input signal level automatically.

The AGC flat levels (150mV, 300mV, 400mV and 540mV) are selectable via I<sup>2</sup>C bus. (Refer to the following figure.)

AGC Control

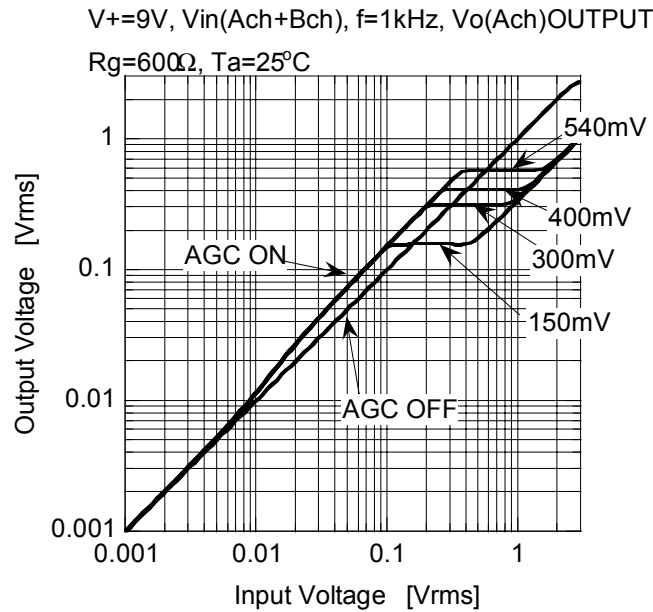

Attack-Recovery

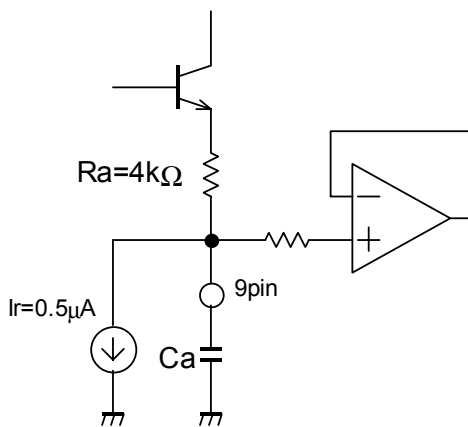

Smoothing circuit of Attenuate

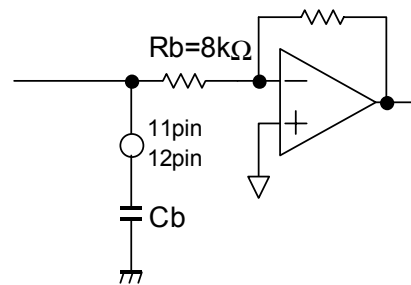

Smoothing circuit of Boost

Attack and recovery time in the attenuation processing depends on external part Ca, and it in the boost processing depends on external part Cb. They become longer as the capacity bigger and become shorter as it gets smaller. (Recommendation value: Ca=1μF, Cb=4.7μF)

Reducing the capacity of Ca may cause the distortion. As for Cb, since it serves as the click noise prevention, reducing the capacity may cause the click noise upon volume changing.

2. Tone Control

a) Bass: Setting the Cut-off frequency

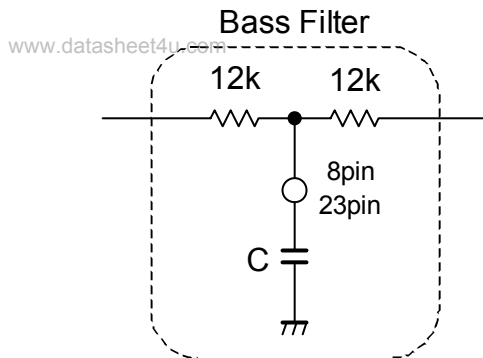

$$f_c = \frac{M}{2\pi \times C \times 12k}$$

M changes by gain setting of Tone.

- M ≈ 2.65 (±15dB)
- M ≈ 3.45 (±10dB)
- M ≈ 8.10 (±5dB)

b) Treble: Setting the Cut-off frequency

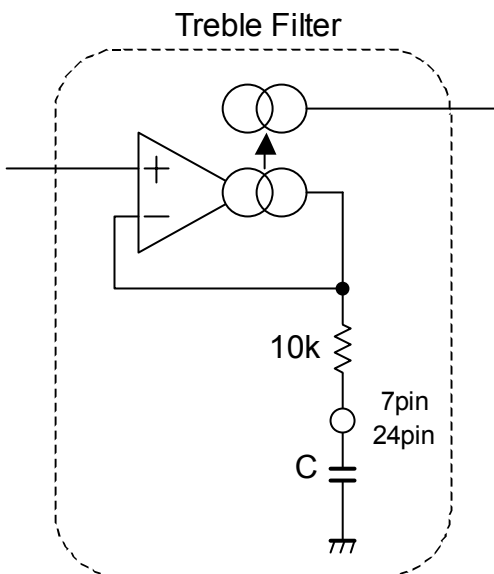

$$f_c = \frac{N}{2\pi \times C \times 10k}$$

N changes by gain setting of Tone.

- N ≈ 0.76 (±15dB)
- N ≈ 0.58 (±10dB)
- N ≈ 0.25 (±5dB)

3. BBE, Surround mode and "OUT" switch settings

The click noise may be generated by changing the BBE, Surround mode setting and "OUT" switch. Provide the external circuit for avoiding the click noise on above condition.

4. External parts for BBE circuits

The constant of capacitors connected to the terminals No.2, 3, 28 and 29 are designated by BBE Sound Inc. Do not change the constant of these capacitors without the approval of BBE Sound Inc.

5. AUX1, AUX0 Terminal

AUX1/0 are enable to control external logic circuit is

- Source current : 1mA typ. (Ta=25°C)
- Sink current : 0.5mA typ. (Ta=25°C)

6. Capacitor for Reference Voltage (21pin)

22μF should be recommended for ripple filter connected to Vref terminal (21pin).

Reducing this capacity may cause to reduce the maximum attenuation level and to increase the output noise.

■ DEFINITION OF I<sup>2</sup>C REGISTER

◆ I<sup>2</sup>C BUS FORMAT

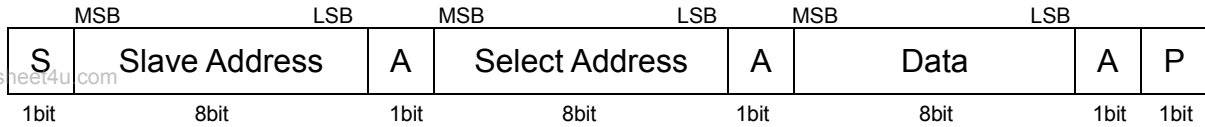

S: Starting Term  
 A: Acknowledge Bit  
 P: Ending Term

◆ SLAVE ADDRESS

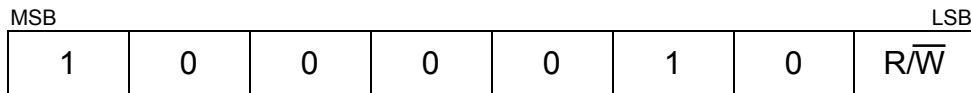

R/W=0: Receive Only  
 R/W=1: No Output Data

◆ CONTROL REGISTER TABLE

The select address sets each function (Volume, Balance, AGC, Surround, Tone Control, BBE, AUX).  
 The auto increment function cycles the select address as follows.  
 00H→01H→02H→03H→04H→05H→00H

Select Address	BIT							
	D7	D6	D5	D4	D3	D2	D1	D0
00H	VOL							
01H	CHS	BAL				AGC	SUR	
02H	BCB	BASS			BCSB	SUB-BASS		
03H	BCT	TREB			BCST	SUB-TREB		
04H	BBE (Lo Contour)				BBE (Process)			
05H	OUT	Don't care	Don't care	SUR0	AGC1	AGC0	AUX1	AUX0

◆ CONTROL REGISTER DEFAULT VALUE

Control register default value is all "0".

Select Address	BIT							
	D7	D6	D5	D4	D3	D2	D1	D0
00H	0	0	0	0	0	0	0	0
01H	0	0	0	0	0	0	0	0
02H	0	0	0	0	0	0	0	0
03H	0	0	0	0	0	0	0	0
04H	0	0	0	0	0	0	0	0
05H	0	0	0	0	0	0	0	0

■ INSTRUCTION CODE

a) MASTER VOLUME SETTING

Select Address	BIT							
	D7	D6	D5	D4	D3	D2	D1	D0
00H	VOL							

The volume control for both Ach and Bch (0.33dB/step).

The volume is consisted of volume1 and volume2 and the level is divided into half to each volume1 and volume2.

b) BALANCE, AGC AND SURROUND SETTING

Select Address	BIT							
	D7	D6	D5	D4	D3	D2	D1	D0
01H	CHS	BAL					AGC	SUR

- CHS: Channel select for balance control

"0": Ach "Bch is attenuated"

"1": Bch "Ach is attenuated"

- BAL: Balance control for both Ach and Bch (1dB/Step)

The balance is consisted of volume1 and volume2 and the level is divided into half to each volume1 and volume2.

- AGC: AGC switch

"0": AGC OFF

"1": AGC ON

- SUR: Surround mode switch

"0": Surround OFF

"1": Surround ON

NOTE) The click noise may be generated by changing the Surround mode setting.  
Provide the external circuit for avoiding the click noise on above condition.

c) TONE CONTROL BASS SETTING

Select Address	BIT							
	D7	D6	D5	D4	D3	D2	D1	D0
02H	BCB	BASS				BCSB	SUB-BASS	

- BCB: Boost cut select for Bass control

"0": Cut

"1": Boost

- BASS: BASS control

Cut Level : -15dB to 0dB(1dB/Step)

Boost Level : 0dB to +15dB(1dB/Step)

- BCSB: Boost cut select for SUB-BASS control

"0": Cut

"1": Boost

- SUB-BASS: SUB- BASS control (1dB/Step)

Sub-Cut Level : -3dB to 0dB(1dB/Step)

Sub-Boost Level : 0dB to +3dB(1dB/Step)

**d) TONE CONTROL TREBLE SETTING**

Select Address	BIT							
	D7	D6	D5	D4	D3	D2	D1	D0
<b>03H</b>	<b>BCT</b>	<b>TREB</b>				<b>BCST</b>	<b>SUB-TREB</b>	

- BCT: Boost cut select for Treble control  
 "0": Cut  
 "1": Boost
- TREB: Treble control (1dB/step)  
 Cut Level : -15dB to 0dB(1dB/Step)  
 Boost Level : 0dB to +15dB(1dB/Step)
- BCST: Boost cut select for Sub-Treble control  
 "0": Cut  
 "1": Boost
- SUB-TREB: Sub-Treble control (1dB/step)  
 Sub-Cut Level : -3dB to 0dB(1dB/Step)  
 Sub-Boost Level : 0dB to +3dB(1dB/Step)

**e) BBE Boost Level Setting**

Select Address	BIT							
	D7	D6	D5	D4	D3	D2	D1	D0
<b>04H</b>	<b>BBE (Lo Contour)</b>				<b>BBE (Process)</b>			

- BBE Lo Contour : 0dB to 15dB(1dB/step)
- BBE Process : 0dB to 15dB (1dB/step)

When all bits are "0"(=00H), BBE becomes off

NOTE) The click noise may be generated by changing the BBE setting.  
 Provide the external circuit for avoiding the click noise on above condition.

**f) OUTPUT AND AUXILIARY SETTING**

Select Address	BIT							
	D7	D6	D5	D4	D3	D2	D1	D0
<b>05H</b>	<b>OUT</b>	Don't Care	Don't Care	<b>SUR0</b>	<b>AGC1</b>	<b>AGC0</b>	<b>AUX1</b>	<b>AUX0</b>

- OUT: ON/OFF Switch for OUTPUT  
 "0" : OFF  
 "1" : ON

NOTE) The click noise may be generated by changing the "OUT" switch.  
 Provide the external circuit for avoiding the click noise on above condition.

•Surround Setting

Surround Function	SUR0(05H:D4)	SUR(01H:D0),	Remarks
Surround OFF	0	0	Input through
Surround Effect1	0	1	Surround Effect Small ( 8.0dB typ. )
Surround Effect2	1	1	Surround Effect Large (12.7dB typ. )
Simulated Stereo	1	0	For monaural signal input only

NOTE) The click noise may be generated by changing the Surround mode setting.  
 Provide the external circuit for avoiding the click noise on above condition.

•AGC Level Setting

AGC Level	AGC1(D3)	AGC0(D2)
150mVrms	0	0
300mVrms	0	1
400mVrms	1	0
540mVrms	1	1

www.datasheet4u.com

•AUX1/AUX0: Auxiliary port High/Low

“0”: Logic output ”Low”

“1”: Logic output ”High”

■MASTER VOLUME (Select Address: 00H)

		VOL							
Gain (dB)	HEX	D7	D6	D5	D4	D3	D2	D1	D0
0	FF	1	1	1	1	1	1	1	1
-1	FC	1	1	1	1	1	1	0	0
-2	F9	1	1	1	1	1	0	0	1
-3	F6	1	1	1	1	0	1	1	0
-4	F3	1	1	1	1	0	0	1	1
-5	F0	1	1	1	1	0	0	0	0
-6	ED	1	1	1	0	1	1	0	1
-7	EA	1	1	1	0	1	0	1	0
-8	E7	1	1	1	0	0	1	1	1
-9	E4	1	1	1	0	0	1	0	0
-10	E1	1	1	1	0	0	0	0	1
-11	DE	1	1	0	1	1	1	1	0
-12	DB	1	1	0	1	1	0	1	1
-13	D8	1	1	0	1	1	0	0	0
-14	D5	1	1	0	1	0	1	0	1
-15	D2	1	1	0	1	0	0	1	0
-16	CF	1	1	0	0	1	1	1	1
-17	CC	1	1	0	0	1	1	0	0
-18	C9	1	1	0	0	1	0	0	1
-19	C6	1	1	0	0	0	1	1	0
-20	C3	1	1	0	0	0	0	1	1
-21	C0	1	1	0	0	0	0	0	0
-22	BD	1	0	1	1	1	1	0	1
-23	BA	1	0	1	1	1	0	1	0
-24	B7	1	0	1	1	0	1	1	1
-25	B4	1	0	1	1	0	1	0	0
-26	B1	1	0	1	1	0	0	0	1
-27	AE	1	0	1	0	1	1	1	0
-28	AB	1	0	1	0	1	0	1	1
-29	A8	1	0	1	0	1	0	0	0
-30	A5	1	0	1	0	0	1	0	1
-31	A2	1	0	1	0	0	0	1	0
-32	9F	1	0	0	1	1	1	1	1
-33	9C	1	0	0	1	1	1	0	0
-34	99	1	0	0	1	1	0	0	1
-35	96	1	0	0	1	0	1	1	0
-36	93	1	0	0	1	0	0	1	1
-37	90	1	0	0	1	0	0	0	0
-38	8D	1	0	0	0	1	1	0	1
-39	8A	1	0	0	0	1	0	1	0
-40	87	1	0	0	0	0	1	1	1
-41	84	1	0	0	0	0	1	0	0
-42	81	1	0	0	0	0	0	0	1



■MASTER VOLUME (Select Address: 00H)

		VOL							
Gain (dB)	HEX	D7	D6	D5	D4	D3	D2	D1	D0
-43	7E	0	1	1	1	1	1	1	0
-44	7B	0	1	1	1	1	0	1	1
-45	78	0	1	1	1	1	0	0	0
-46	75	0	1	1	1	0	1	0	1
-47	72	0	1	1	1	0	0	1	0
-48	6F	0	1	1	0	1	1	1	1
-49	6C	0	1	1	0	1	1	0	0
-50	69	0	1	1	0	1	0	0	1
-51	66	0	1	1	0	0	1	1	0
-52	63	0	1	1	0	0	0	1	1
-53	60	0	1	1	0	0	0	0	0
-54	5D	0	1	0	1	1	1	0	1
-55	5A	0	1	0	1	1	0	1	0
-56	57	0	1	0	1	0	1	1	1
-57	54	0	1	0	1	0	1	0	0
-58	51	0	1	0	1	0	0	0	1
-59	4E	0	1	0	0	1	1	1	0
-60	4B	0	1	0	0	1	0	1	1
-61	48	0	1	0	0	1	0	0	0
-62	45	0	1	0	0	0	1	0	1
-63	42	0	1	0	0	0	0	1	0
-64	3F	0	0	1	1	1	1	1	1
-65	3C	0	0	1	1	1	1	0	0
-66	39	0	0	1	1	1	0	0	1
-67	36	0	0	1	1	0	1	1	0
-68	33	0	0	1	1	0	0	1	1
-69	30	0	0	1	1	0	0	0	0
-70	2D	0	0	1	0	1	1	0	1
-71	2A	0	0	1	0	1	0	1	0
-72	27	0	0	1	0	0	1	1	1
-73	24	0	0	1	0	0	1	0	0
-74	21	0	0	1	0	0	0	0	1
-75	1E	0	0	0	1	1	1	1	0
-76	1B	0	0	0	1	1	0	1	1
-77	18	0	0	0	1	1	0	0	0
-78	15	0	0	0	1	0	1	0	1
-79	12	0	0	0	1	0	0	1	0
-80	0F	0	0	0	0	1	1	1	1
-81	0C	0	0	0	0	1	1	0	0
-82	09	0	0	0	0	1	0	0	1
-83	06	0	0	0	0	0	1	1	0
-84	03	0	0	0	0	0	0	1	1
Mute	00	0	0	0	0	0	0	0	0

### ■BALANCE (Select Address: 01H)

Channel Select (CHS)	D7
Ach (Bch is attenuated)	0
Bch (Ach is attenuated)	1

Gain (dB)	BAL				
	D6	D5	D4	D3	D2
0	0	0	0	0	0
-1	0	0	0	0	1
-2	0	0	0	1	0
-3	0	0	0	1	1
-4	0	0	1	0	0
-5	0	0	1	0	1
-6	0	0	1	1	0
-7	0	0	1	1	1
-8	0	1	0	0	0
-9	0	1	0	0	1
-10	0	1	0	1	0
-11	0	1	0	1	1
-12	0	1	1	0	0
-13	0	1	1	0	1
-14	0	1	1	1	0
-15	0	1	1	1	1
-16	1	0	0	0	0
-17	1	0	0	0	1
-18	1	0	0	1	0
-19	1	0	0	1	1
-20	1	0	1	0	0
-21	1	0	1	0	1
-22	1	0	1	1	0
-23	1	0	1	1	1
-24	1	1	0	0	0
-25	1	1	0	0	1
-26	1	1	0	1	0
-27	1	1	0	1	1
-28	1	1	1	0	0
-29	1	1	1	0	1
-30	1	1	1	1	0
Mute	1	1	1	1	1

■TONE CONTROL BASS (Select Address: 02H)

Bass Cut or Boost	BCB
	D7
Cut	0
Boost	1

www.datasheet4u.com

		BASS			
		D6	D5	D4	D3
Cut Gain (dB)	Boost Gain (dB)				
-15	15	1	1	1	1
-14	14	1	1	1	0
-13	13	1	1	0	1
-12	12	1	1	0	0
-11	11	1	0	1	1
-10	10	1	0	1	0
-9	9	1	0	0	1
-8	8	1	0	0	0
-7	7	0	1	1	1
-6	6	0	1	1	0
-5	5	0	1	0	1
-4	4	0	1	0	0
-3	3	0	0	1	1
-2	2	0	0	1	0
-1	1	0	0	0	1
0	0	0	0	0	0

■TONE CONTROL SUB-BASS (Select Address: 02H)

Sub-Bass Cut or Boost	BCSB
	D2
Cut	0
Boost	1

		SUB-BASS	
		D1	D0
Cut Gain (dB)	Boost Gain (dB)		
-3	3	1	1
-2	2	1	0
-1	1	0	1
0	0	0	0

■TONE CONTROL TREBLE (Select Address: 03H)

Treble Cut or Boost	BCT
	D7
Cut	0
Boost	1

www.datasheet4u.com

		TREB			
		D6	D5	D4	D3
Cut Gain (dB)	Boost Gain (dB)				
-15	15	1	1	1	1
-14	14	1	1	1	0
-13	13	1	1	0	1
-12	12	1	1	0	0
-11	11	1	0	1	1
-10	10	1	0	1	0
-9	9	1	0	0	1
-8	8	1	0	0	0
-7	7	0	1	1	1
-6	6	0	1	1	0
-5	5	0	1	0	1
-4	4	0	1	0	0
-3	3	0	0	1	1
-2	2	0	0	1	0
-1	1	0	0	0	1
0	0	0	0	0	0

■TONE CONTROL SUB-TREBLE (Select Address : 03H)

Sub-Treble Cut or Boost	BCST
	D2
Cut	0
Boost	1

		SUB-TREB	
		D1	D1
Cut Gain (dB)	Boost Gain (dB)		
-3	3	1	1
-2	2	1	0
-1	1	0	1
0	0	0	0

■BBE (Lo Contour) / (Process) Gain Code (Select Address: 04H)

www.dash

Gain (dB)	Lo Contour				Process			
	D7	D6	D5	D4	D3	D2	D1	D0
15	1	1	1	1	1	1	1	1
14	1	1	1	0	1	1	1	0
13	1	1	0	1	1	1	0	1
12	1	1	0	0	1	1	0	0
11	1	0	1	1	1	0	1	1
10	1	0	1	0	1	0	1	0
9	1	0	0	1	1	0	0	1
8	1	0	0	0	1	0	0	0
7	0	1	1	1	0	1	1	1
6	0	1	1	0	0	1	1	0
5	0	1	0	1	0	1	0	1
4	0	1	0	0	0	1	0	0
3	0	0	1	1	0	0	1	1
2	0	0	1	0	0	0	1	0
1	0	0	0	1	0	0	0	1
0	0	0	0	0	0	0	0	0

## ■ TYPICAL CHARACTERISTICS

**Supply Current vs Supply Voltage**

Ta=25°C

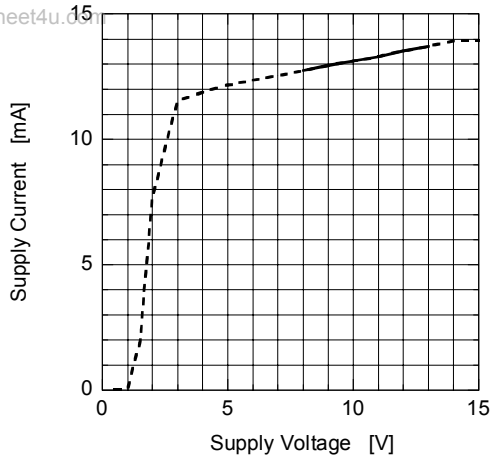

**Supply Current vs Temperature**

V+=9V

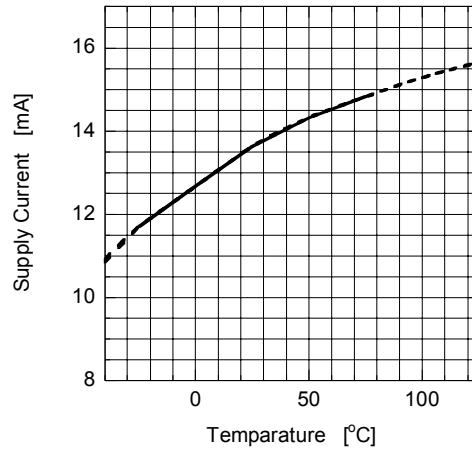

**Gain vs Volume Control**

V+=9V, Vin(Ach)=1Vrms, f=1kHz, OUTPUT, Rg=600Ω

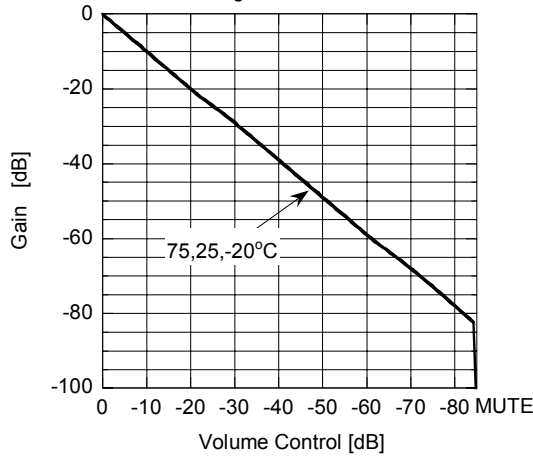

**Gain vs Balance Control**

V+=9V, Vin=1Vrms, f=1kHz, Rg=600Ω

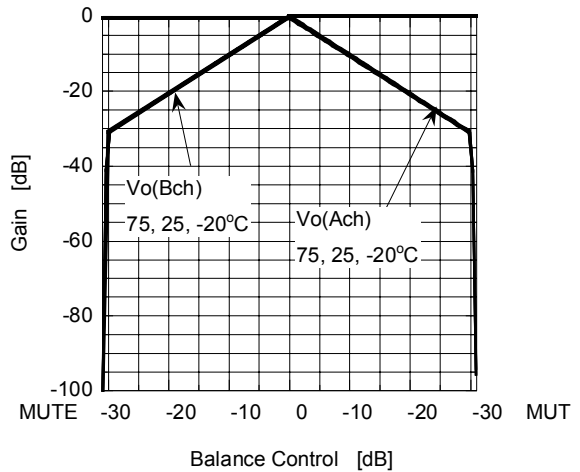

**Output Noise vs Volume Control**

V+=9V, OUTPUT, BW=400-30kHz, Rg=600Ω, Ta=25°C

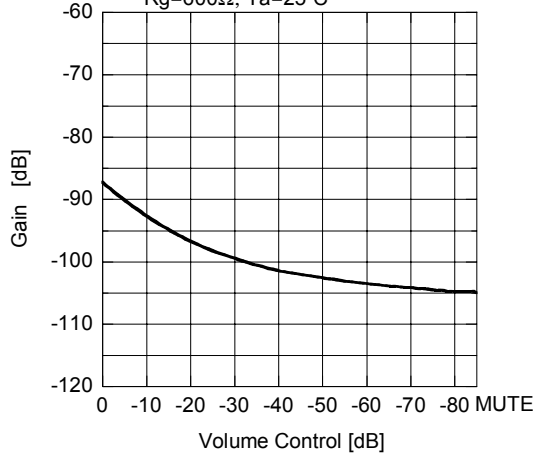

**Output Noise vs Temperature**

V+=9V, Rg=600Ω, BW=400Hz-30kHz

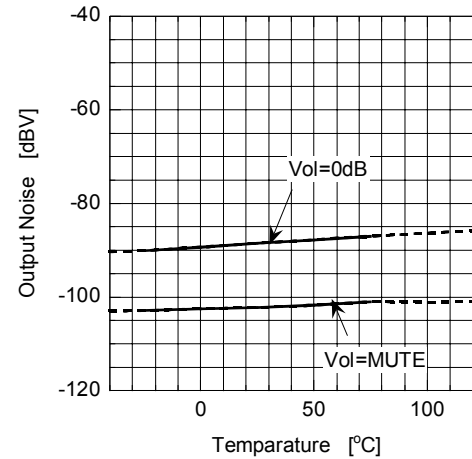

■TYPICAL CHARACTERISTICS

**THD+N vs Input Voltage**

V+=9V, Vin(Ach), f=1kHz, Vo(Ach)OUTPUT  
Rg=600Ω, BW=400Hz-30kHz, Ta=25°C

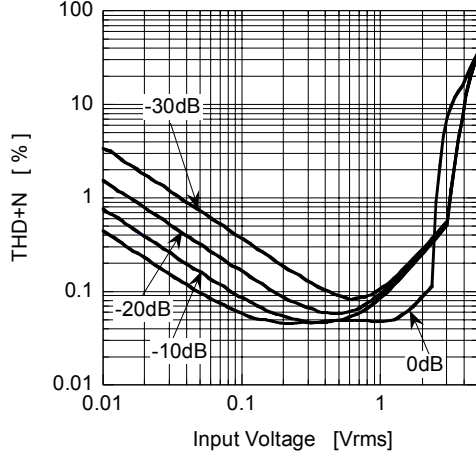

**THD+N vs Input Voltage**

V+=9V, Vin(Ach), f=1kHz, Vo(Ach)OUTPUT  
Rg=600Ω, BW=400Hz-30kHz, Vol=-20dB

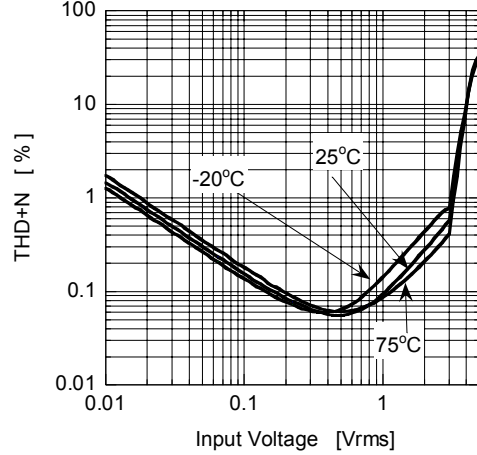

**THD+N vs Output Voltage**

V+=9V, Vin(Ach), f=1kHz, Vo(Ach)OUTPUT  
BW=400Hz-30kHz, Rg=600Ω, Ta=25°C

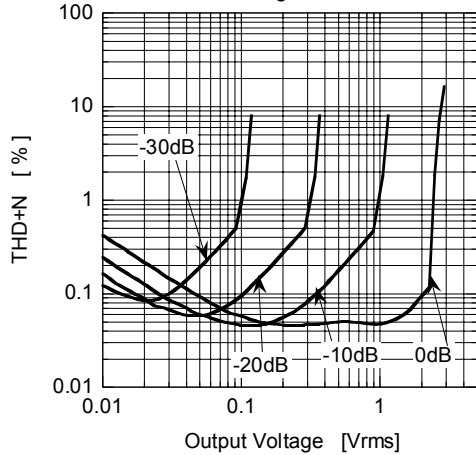

**THD+N vs Output Voltage**

V+=9V, Vin(Ach), f=1kHz, Vo(Ach)OUTPUT  
Rg=600Ω, BW=400Hz-30kHz, Vol=0dB

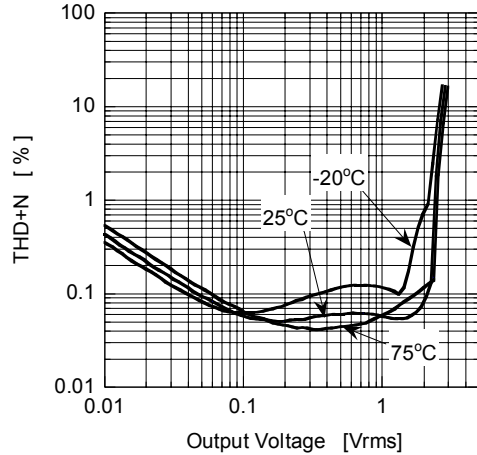

**MUTE Level vs Frequency**

V+=9V, Vin(Ach)=1Vrms, Vol=MUTE  
Vo(Ach)OUTPUT, Rg=600Ω, Ta=25°C

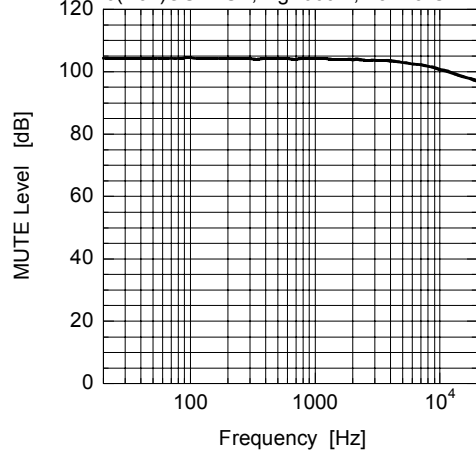

**Channel Separation vs Frequency**

V+=9V, Vin=2Vrms, f=1kHz, Vo=OUTPUT  
Rg=600Ω, Vol=0dB, Ta=25°C

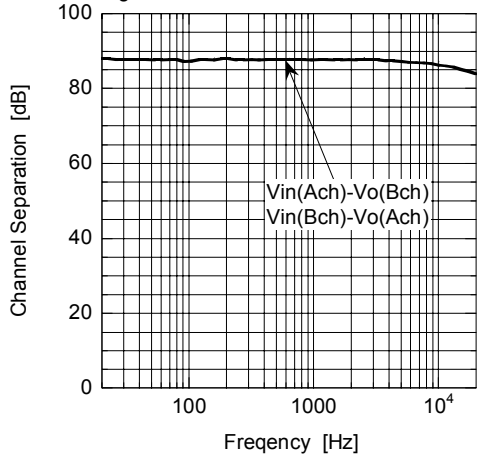

■TYPICAL CHARACTERISTICS

Gain vs Frequency (TONE)

V+=9V, Vin(Ach)=0.1Vrms, Gv:3dB steps  
Vo(Ach), Rg=600Ω, Ta=25°C

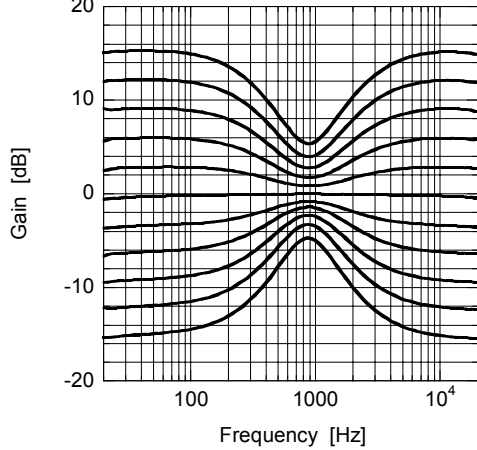

Gain vs Frequency (TONE)

V+=9V, Vin(Ach)=0.1Vrms, Gv= +/-15dB  
Vo(Ach), Rg=600Ω, Ta=25°C

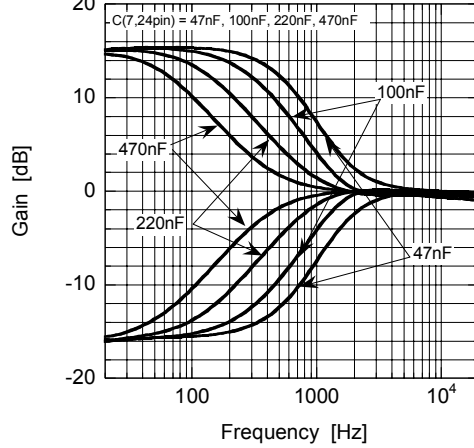

Gain vs Frequency (TONE)

V+=9V, Vin(Ach)=0.1Vrms, Gv= +/-15dB  
Vo(Ach), Rg=600Ω, Ta=25°C

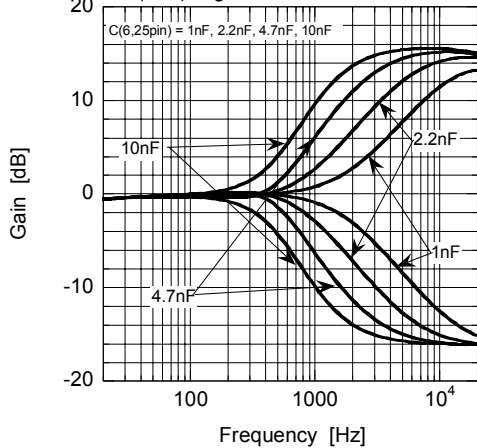

AGC Control

V+=9V, Vin(Ach+Bch), f=1kHz, Vo(Ach)OUTPUT  
Rg=600Ω, Ta=25°C

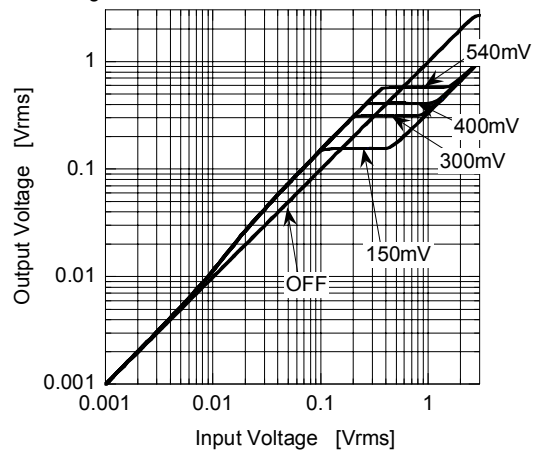

AGC Attack Time (C:9pin=1μF)

V+=9V, Vin(Ach+Bch)=1Vrms, f=20kHz, Vo(Ach)OUTPUT  
AGC level=0.15V, Rg=600Ω, Ta=25°C

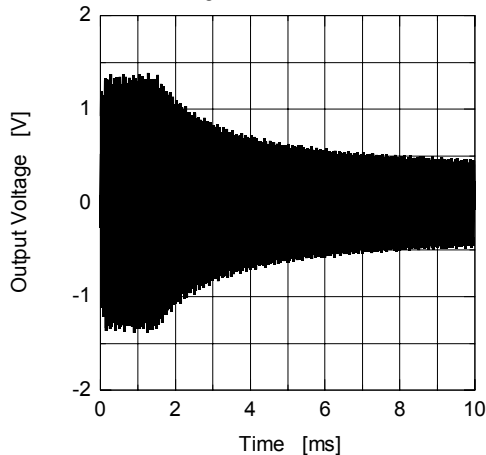

AGC Recovery Time (C:9pin=1μF)

V+=9V, Vin(Ach+Bch)=1Vrms, f=10kHz, Vo(Ach)OUTPUT  
AGC level=0.15V, Rg=600Ω, Ta=25°C

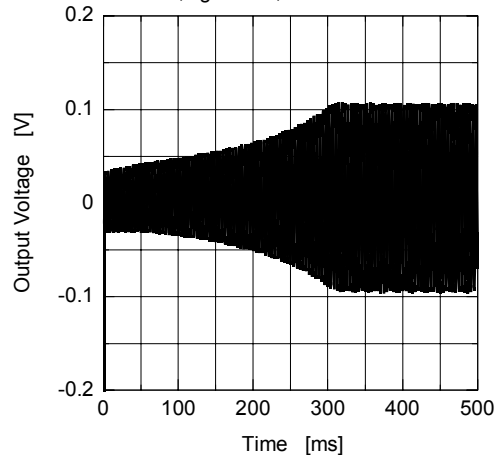



■TYPICAL CHARACTERISTICS

**AGC Attack Time (C:9pin=2.2 μF)**

V+=9V, Vin(Ach+Bch)=1Vrms, f=20kHz, Vo(Ach)OUTPUT  
 AGC level=0.15V, Rg=600Ω, Ta=25°C

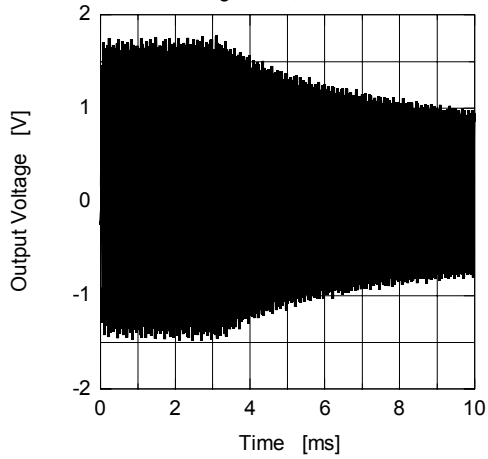

**AGC Recovery Time (C:9pin=2.2 μF)**

V+=9V, Vin(Ach+Bch)=1 to 0.05Vrms, f=10kHz,  
 Vo(Ach)OUTPUT, AGC level=0.15V, Rg=600Ω, Ta=25°C

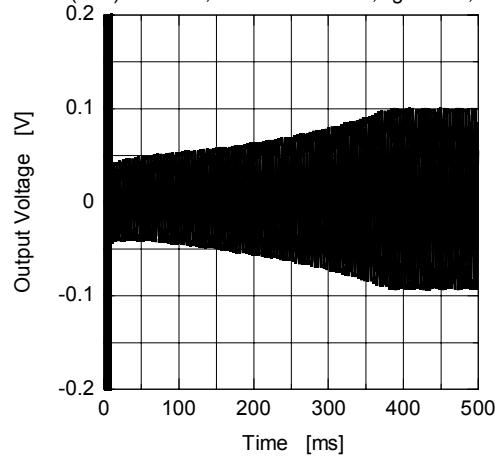

**AGC Attack Time (C:9pin=0.47 μF)**

V+=9V, Vin(Ach+Bch)=1Vrms, f=20kHz, Vo(Ach)OUTPUT  
 AGC level=0.15V, Rg=600Ω, Ta=25°C

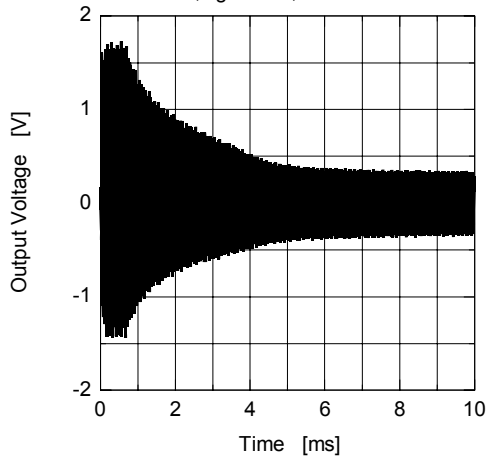

**AGC Recovery Time (C:9pin=0.47 μF)**

V+=9V, Vin(Ach+Bch)=1 to 0.05Vrms, f=10kHz,  
 Vo(Ach)OUTPUT, AGC level=0.15V, Rg=600Ω, Ta=25°C

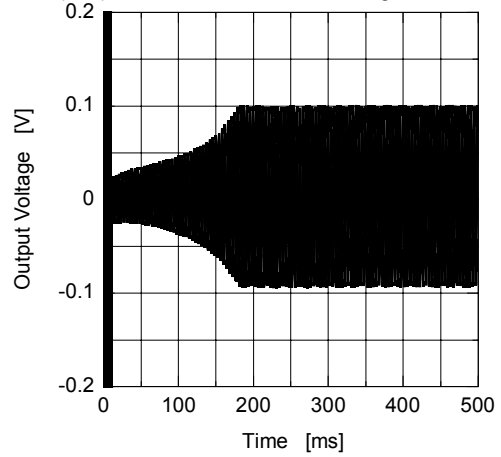

■ TYPICAL CHARACTERISTICS

**Gain vs Frequency (eala&Simulated)**

V+=9V, Vin=0.1Vrms, OUTPUT, Rg=600Ω, Ta=25°C

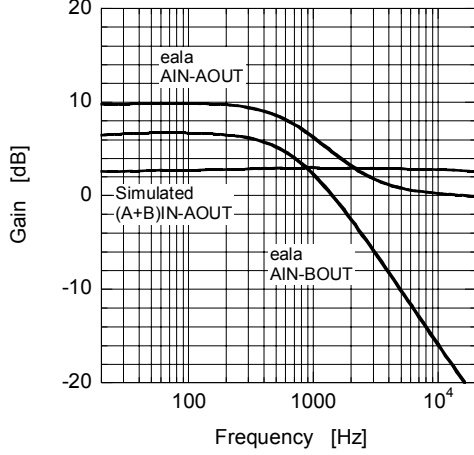

**Phase vs Frequency (Simulated)**

V+=9V, Vin(A+Bch)=0.1Vrms, Rg=600Ω, Ta=25°C

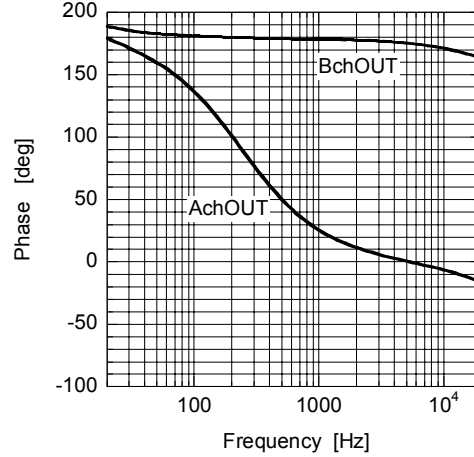

**Gain vs Frequency (BBE)**

V+=9V, Vin(Ach)=0.1Vrms, Gv=3dB steps OUTPUT, Rg=600Ω, Ta=25°C

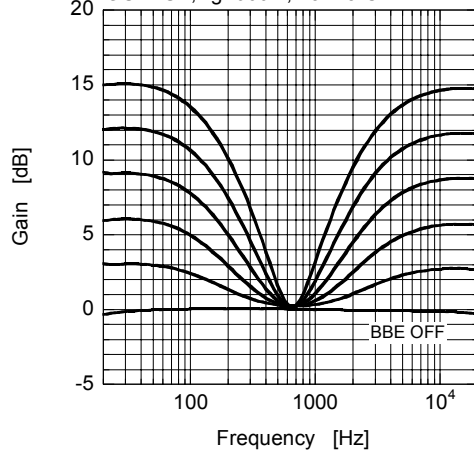

**Phase vs Frequency (BBE)**

V+=9V, Vin(Ach)=0.1Vrms, Vo(Ach) Gv:3dB steps, Rg=600Ω, Ta=25°C

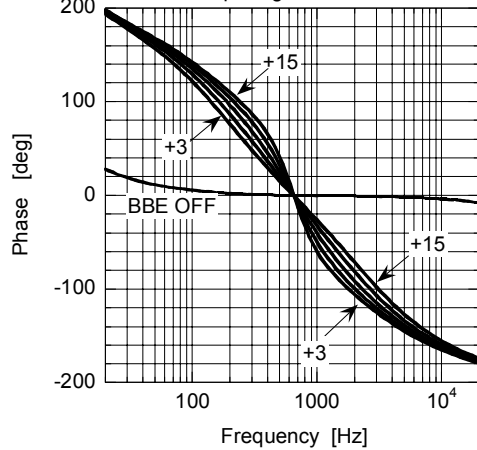

■NOTE

The **NJW1164** is manufactured by New Japan Radio Co., Ltd. under license from BBE Sound Inc. A license from BBE Sound Inc. is required before the **NJW1164** can be purchased from New Japan Radio Co., Ltd.

[www.datasheet4u.com](http://www.datasheet4u.com)

BBE Sound, Inc.  
5381 Production Drive  
Huntington Beach, CA 92649  
Tel:(714) 897-6766  
Fax:(714) 896-0736

Purchase of I<sup>2</sup>C components of New Japan Radio Co., Ltd or one of its sublicensed Associated Companies conveys a license under the Philips I<sup>2</sup>C Patent Rights to use these components in an I<sup>2</sup>C system, provided that the system conforms to the I<sup>2</sup>C Standard Specification as defined by Philips.

[CAUTION]

The specifications on this databook are only given for information, without any guarantee as regards either mistakes or omissions. The application circuits in this databook are described only to show representative usages of the product and not intended for the guarantee or permission of any right including the industrial rights.