



## AUDIO PROCESSOR with BBE ViVA+

### ■ GENERAL DESCRIPTION

The **NJW1175** is a TV audio processor with BBE ViVA+ High Definition 3D Sound process. BBE's traditional sound clarity enhancement technology is combined with the Mach3BASS process to bass enhancement and the new ViVA 3D process to create an authentic and exciting spatial effect.

The **NJW1175** contains all necessary functions to process TV audio signal such as volume control, tone control, balance, mute and AGC function.

### ■ PACKAGE OUTLINE

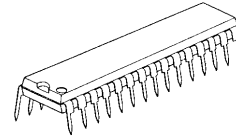

NJW1175L



NJW1175V

### ■ FEATURES

- Operating Voltage        7.5 to 13V
- I<sup>2</sup>C BUS Interface
- BBE Sound Enhancement (Low Boost and High Boost: 15dB max.)
- BBE ViVA HD3D Sound
- BBE Mach3BASS
- eala(NJRC Surround)/Simulated Stereo
- AGC Circuit (Selectable 4-stage compression level by I<sup>2</sup>C BUS)
- Bi-CMOS Technology
- Package Outline        SDIP30, SSOP32

### ■ BLOCK DIAGRAM

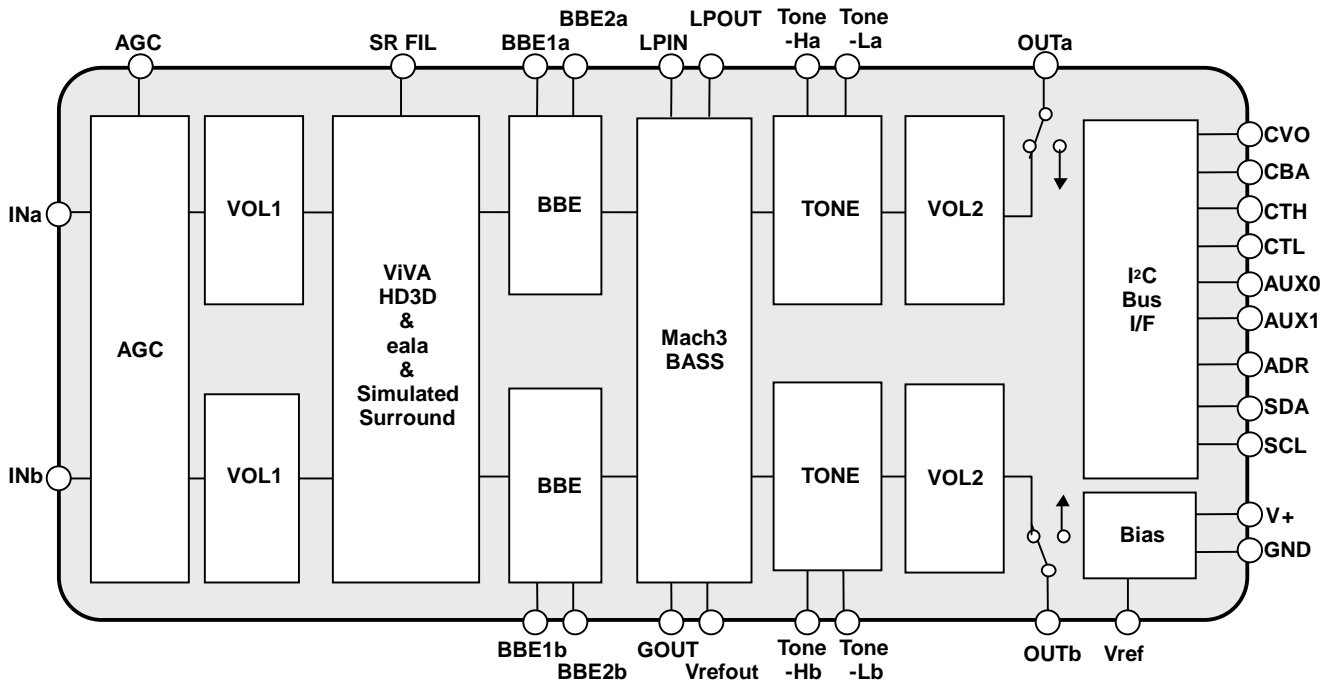

## ■ PIN FUNCTION (SDIP30)

1	INa	INb	30
2	BBE1a	BBE1b	29
3	BBE2a	BBE2b	28
4	GOUT	LPIN	27
5	Vrefout	LPOUT	26
6	TONE-Ha	TONE-Hb	25
7	TONE-La	TONE-Lb	24
8	OUTa	OUTb	23
9	AGC	SR-FIL	22
10	ADR	VREF	21
11	CBA	CTH	20
12	CVO	CTL	19
13	SDA	AUX0	18
14	SCL	AUX1	17
15	GND	V+	16

No.	Symbol	Function	No	Symbol	Function
1	INa	Ach Input	16	V+	Power Supply Terminal
2	BBE1a	Ach BBE Filter1 (Process)	17	AUX1	Auxiliary Output1
3	BBE2a	Ach BBE Filter2 (Lo Contour)	18	AUX0	Auxiliary Output0
4	GOUT	BBE Mach3BASS Filter	19	CTL	Pop Noise reduction for Bass Control
5	Vrefout	BBE Mach3BASS Filter	20	CTH	Pop Noise reduction for Treble Control
6	TONE-Ha	Ach Treble Filter	21	VREF	Reference Voltage
7	TONE-La	Ach Bass Filter	22	SR-FIL	Surround Filter
8	OUTa	Ach Output	23	OUTb	Bch Output
9	AGC	AGC Filter	24	TONE-Lb	Bch Bass Filter
10	ADR	Slave address setting terminal	25	TONE-Hb	Bch Treble Filter
11	CBA	Pop Noise Reduction for Balance	26	LPOUT	BBE Mach3BASS Filter
12	CVO	Pop Noise Reduction for Volume	27	LPIN	BBE Mach3BASS Filter
13	SDA	SDA Data Input (I <sup>2</sup> C BUS)	28	BBE2b	Bch BBE Filter2 (Process)
14	SCL	SCL Data Input (I <sup>2</sup> C BUS)	29	BBE1b	Bch BBE Filter1 (Lo Contour)
15	GND	Ground Terminal	30	INb	Bch Input

### ■ PIN FUNCTION (SSOP32)

1	INa	INb	32
2	BBE1	BBE1	31
3	BBE2	BBE2	30
4	GOUT	LPIN	29
5	Vrefout	LPOUT	28
6	TONE-Ha	TONE-Hb	27
7	TONE-La	TONE-Lb	26
8	NC	NC	25
9	OUTa	OUTb	24
10	AGC	SR-FIL	23
11	ADR	VREF	22
12	CBA	CTH	21
13	CVO	CTL	20
14	SDA	AUX0	19
15	SCL	AUX1	18
16	GND	V+	17

No.	Symbol	Function		Symbol	Function
1	INa	Ach Input	17	V+	Power Supply Terminal
2	BBE1a	Ach BBE Filter1 (Process)	18	AUX1	Auxiliary Output1
3	BBE2a	Ach BBE Filter2 (Lo Contour)	19	AUX0	Auxiliary Output0
4	GOUT	BBE Mach3BASS Filter	20	CTL	Pop Noise reduction for Bass Control
5	Vrefout	BBE Mach3BASS Filter	21	CTH	Pop Noise reduction for Treble Control
6	TONE-Ha	Ach Treble Filter	22	VREF	Reference Voltage
7	TONE-La	Ach Bass Filter	23	SR-FIL	Surround Filter
8	NC	No Connection	24	OUTb	Bch Output
9	OUTa	Ach Output	25	NC	No Connection
10	AGC	AGC Filter	26	TONE-Lb	Bch Bass Filter
11	ADR	Slave address setting terminal	27	TONE-Hb	Bch Treble Filter
12	CBA	Pop Noise Reduction for Balance	28	LPOUT	BBE Mach3BASS Filter
13	CVO	Pop Noise Reduction for Volume	29	LPIN	BBE Mach3BASS Filter
14	SDA	SDA Data Input (I <sup>2</sup> C BUS)	30	BBE2b	Bch BBE Filter2 (Process)
15	SCL	SCL Data Input (I <sup>2</sup> C BUS)	31	BBE1b	Bch BBE Filter1 (Lo Contour)
16	GND	Ground Terminal	32	INb	Bch Input

■ ABSOLUTE MAXIMUM RATING (Ta=25°C)

PARAMETER	SYMBOL	RATING	UNIT
Supply Voltage	V <sup>+</sup>	15	V
Power Dissipation	P <sub>D</sub>	700	mW
Operating Temperature Range	Topr	-20 to +75	°C
Storage Temperature Range	Tstg	-40 to +125	°C

■ ELECTRICAL CHARACTERISTICS

(Ta=25°C, V+=9V, Rg=600Ω, RL=47kΩ, Vin=100mVrms/1kHz unless otherwise specified)

PARAMETER	SYMBOL	TEST CONDITION	MIN.	TYP.	MAX.	UNIT
Operating Voltage	V <sup>+</sup>		7.5	9.0	13.0	V
Supply Current	I <sub>CC</sub>	No Signal	-	13	25	mA
Reference Voltage	V <sub>REF</sub>	No Signal	4.0	4.5	5.0	V
Maximum Input Voltage	V <sub>IM</sub>	VOL=-20dB, THD=1%	2.8	3.0	-	Vrms
Maximum Output Voltage	V <sub>OM</sub>	OUTPUT VOL=0dB, THD=1%	-	2.5	-	Vrms
Channel Balance 1	G <sub>CB1</sub>	VOL=0dB	-1.0	0.0	1.0	dB
Channel Balance 2	G <sub>CB2</sub>	VOL=-70dB, Vin=1Vrms	-2.0	0.0	2.0	dB
Balance Boost A	BA <sub>BST</sub>	CHS="0", BAL="11111"	-2.0	0.0	2.0	dB
Balance Cut A	BA <sub>CUT</sub>	CHS="1", BAL="11111" Vin = 1Vrms	-	-	-70	dB
Balance Boost B	BB <sub>BST</sub>	CHS="1", BAL="11111"	-2.0	0.0	2.0	dB
Balance Cut B	BB <sub>CUT</sub>	CHS="0", BAL="11111" Vin = 1Vrms	-	-	-70	dB
Total Harmonic Distortion	THD	Vo=0.5Vrms BW=400Hz to 30kHz	-	-	0.5	%
Maximum Gain	G <sub>VMAX</sub>	VOL= 0dB	-2.0	0.0	2.0	dB
Minimum Gain	G <sub>VMIN</sub>	VOL= MUTE	-	-100	-90	dB
Channel Separation	CS	Vin = 2Vrms	-	-80	-70	dB
Output Noise 1	V <sub>NO1</sub>	VOL = 0dB BW=400Hz to 30kHz	-	-88 (39.8)	-83 (70.8)	dBV (μVrms)
Output Noise 2	V <sub>NO2</sub>	VOL = MUTE BW = 400Hz to 30kHz	-	-106 (5.0)	-96 (15.8)	dBV (μVrms)
AUX Output Voltage	V <sub>AUX</sub>	Logic Output: High	4.5	-	5.0	V
		Logic Output: Low	0	-	0.3	
ADR Input Voltage	V <sub>ADR</sub>	Input: High 84H	V+/2	-	-	V
		Input: Low 82H	-	-	1.0	

BW: Band Width

◆ TONE CONTROL

PARAMETER	SYMBOL	TEST CONDITION	MIN.	TYP.	MAX.	UNIT
High Frequency Boost	HF <sub>BST</sub>	BCT="1", TREB="1111", f=10kHz	12.5	15.0	17.5	dB
High Frequency Flat	HF <sub>FLT</sub>	TRBE="0000", f=10kHz	-2.0	0.0	2.0	dB
High Frequency Cut	HF <sub>CUT</sub>	BCT="0", TRBE="1111", f=10kHz	-17.5	-15.0	-12.5	dB
Low Frequency Boost	LF <sub>BST</sub>	BCB="1", BASS="1111", f=100Hz	12.5	15.0	17.5	dB
Low Frequency Flat	LF <sub>FLT</sub>	BASS="0000", f=100Hz	-2.0	0.0	2.0	dB
Low Frequency Cut	LF <sub>CUT</sub>	BCB="0", BASS="1111", f=100Hz	-17.5	-15.0	-12.5	dB

## ◆ SUB-TONE CONTROL

PARAMETER	SYMBOL	TEST CONDITION	MIN.	TYP.	MAX.	UNIT
High Frequency Boost	SHF <sub>BST</sub>	BCST="1", SUB-TREB="11", f=10kHz	-	3.0	-	dB
High Frequency Cut	SHF <sub>CUT</sub>	BCST="0", SUB-TREB="11", f=10kHz	-	-3.0	-	dB
Low Frequency Boost	SLF <sub>BST</sub>	BCSB="1", SUB-BASS="11", f=100Hz	-	3.0	-	dB
Low Frequency Cut	SLF <sub>CUT</sub>	BCSB="0", SUB-BASS="11", f=100Hz	-	-3.0	-	dB

## ◆ AGC CONTROL

PARAMETER	SYMBOL	TEST CONDITION	MIN.	TYP.	MAX.	UNIT
AGC Boost	AGC <sub>BST</sub>	Vin=50mVrms, f=1kHz	1.5	3.5	5.5	dB
AGC Flat1	AGC <sub>FLT1</sub>	Vin=150mVrms, f=1kHz	-2.5	0.0	2.5	dB
AGC Flat2	AGC <sub>FLT2</sub>	Vin=300mVrms, f=1kHz	-2.5	0.0	2.5	dB
AGC Flat3	AGC <sub>FLT3</sub>	Vin=400mVrms, f=1kHz	-2.5	0.0	2.5	dB
AGC Flat4	AGC <sub>FLT4</sub>	Vin=540mVrms, f=1kHz	-2.5	0.0	2.5	dB
AGC Cut	AGC <sub>CUT</sub>	Vin=2Vrms, f=1kHz	-14	-10	-6.0	dB

## ◆ BBE

PARAMETER	SYMBOL	TEST CONDITION	MIN.	TYP.	MAX.	UNIT
BBE Low Frequency Boost Range	BBE <sub>LOW</sub>	BBE-Low="1111", f = 50Hz	-	15.0	-	dB
BBE High Frequency Boost Range	BBE <sub>HIGH</sub>	BBE-High="1111", f = 10KHz	-	15.0	-	dB
Mach3BASS Boost Level	Mach3	Mach-BST="1111"	-	15.0	-	dB

## ◆ SURROUND (SURROUND-ON)

PARAMETER	SYMBOL	TEST CONDITION	MIN.	TYP.	MAX.	UNIT
Surround Gain1	SR <sub>GAIN1</sub>	Ain→Aout, f=100Hz SUR0="0", SUR="1"	3.5	5.5	7.5	dB
Surround Gain2	SR <sub>GAIN2</sub>	Ain→Bout, f=100Hz SUR0="0", SUR="1"	-3.0	-1.0	1.0	dB
Surround Gain3	SR <sub>GAIN3</sub>	Ain→Aout, f=100Hz SUR0="1", SUR="1"	8.0	10.0	12.0	dB
Surround Gain4	SR <sub>GAIN4</sub>	Ain→Bout, f=100Hz SUR0="1", SUR="1"	5.0	7.0	9.0	dB
Simulated Surround Gain1	SR <sub>SIM1</sub>	Ain+Bin→Aout, f=1kHz SUR0="1", SUR="0"	1.0	3.0	5.0	dB
Simulated Surround Gain2	SR <sub>SIM2</sub>	Ain+Bin→Bout, f=1kHz SUR0="1", SUR="0"	1.0	3.0	5.0	dB

■ I<sup>2</sup>C BUS BLOCK CHARACTERISTICS (SDA, SCL)

I<sup>2</sup>C BUS Load Conditions (Standard mode): Pull up resistance 4kΩ (Connected to +5V), Load capacitance 200pF (Connected to GND)

I<sup>2</sup>C BUS Load Conditions (Fast mode): Pull up resistance 4kΩ (Connected to +5V), Load capacitance 50pF (Connected to GND)

PARAMETER	SYM BOL	STANDARD MODE			FAST MODE			UNIT
		MIN.	TYP.	MAX.	MIN.	TYP.	MAX.	
Low Level Input Voltage	V <sub>IL</sub>	0.0	-	1.5	0.0	-	1.5	V
High Level Input Voltage	V <sub>IH</sub>	2.7	-	5.0	2.7	-	5.0	V
Hysteresis of Schmitt trigger inputs	V <sub>hys</sub>	-	-	-	0.25	-	-	V
LOW level output voltage (3mA at SDA pin)	V <sub>OL</sub>	0	-	0.4	0	-	0.4	V
Output fall time from V <sub>IHmin</sub> to V <sub>ILmax</sub> with a bus capacitance from 10pF to 400pF	t <sub>of</sub>	-	-	250	<sup>20</sup> +0.1C <sub>b</sub>	-	250	ns
Pulse width of spikes which must be suppressed by the input filter	t <sub>SP</sub>	-	-	-	0	-	50	ns
Input current each I/O pin with an input voltage between 0.1V <sub>DD</sub> and 0.9V <sub>DDmax</sub>	I <sub>i</sub>	-10	-	10	-10	-	10	μA
Capacitance for each I/O pin	C <sub>i</sub>	-	-	10	-	-	10	pF
SCL clock frequency	f <sub>SCL</sub>	-	-	100	-	-	400	kHz
Hold time (repeated) START condition.	t <sub>HD:STA</sub>	4.0	-	-	0.6	-	-	μs
LOW period of the SCL clock	t <sub>LOW</sub>	4.7	-	-	1.3	-	-	μs
HIGH period of the SCL clock	t <sub>HIGH</sub>	4.0	-	-	0.6	-	-	μs
Set-up time for a repeated START condition	t <sub>SU:STA</sub>	4.7	-	-	0.6	-	-	μs
Data hold time	t <sub>HD:DAT</sub>	0	-	3.45	0	-	0.9	μs
Data set-up time	t <sub>SU:DAT</sub>	250	-	-	100	-	-	ns
Rise time of both SDA and SCL signals	t <sub>r</sub>	-	-	1000	-	-	300	ns
Fall time of both SDA and SCL signals	t <sub>f</sub>	-	-	300	-	-	300	ns
Set-up time for STOP condition	t <sub>SU:STO</sub>	4.0	-	-	0.6	-	-	μs
Bus free time between a STOP and START condition	t <sub>BUF</sub>	4.7	-	-	1.3	-	-	μs
Capacitive load for each bus line	C <sub>b</sub>	-	-	400	-	-	400	pF
Noise margin at the LOW level	V <sub>nL</sub>	0.5	-	-	0.5	-	-	V
Noise margin at the HIGH level	V <sub>nH</sub>	1	-	-	1	-	-	V

C<sub>b</sub> ; total capacitance of one bus line in pF.

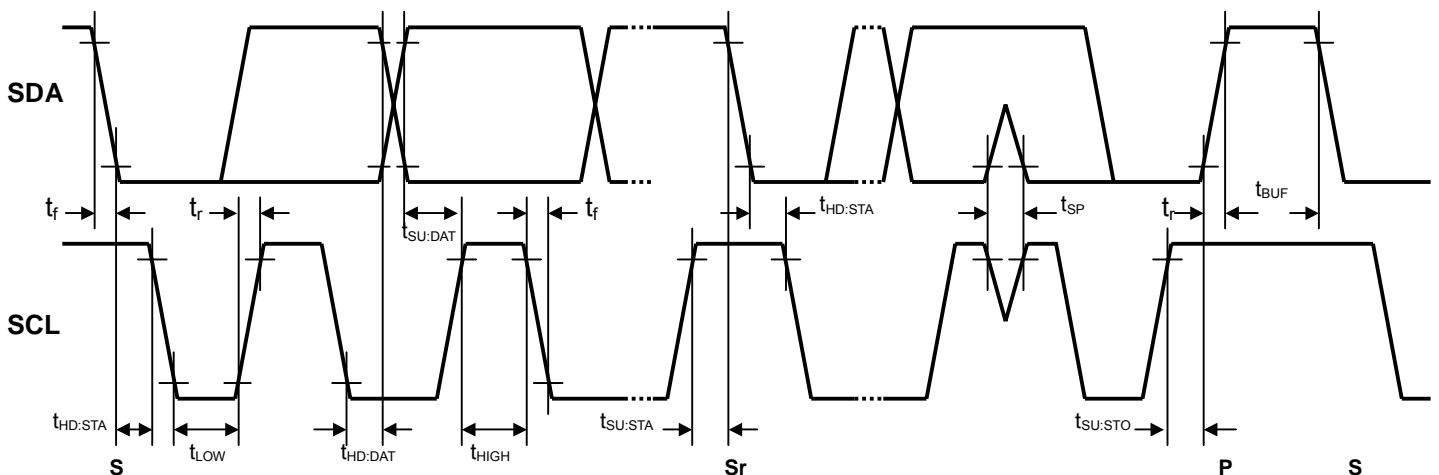

■ **TERMINAL DESCRIPTION**

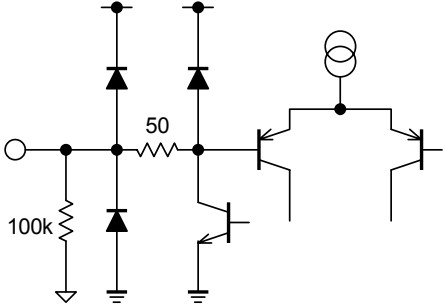
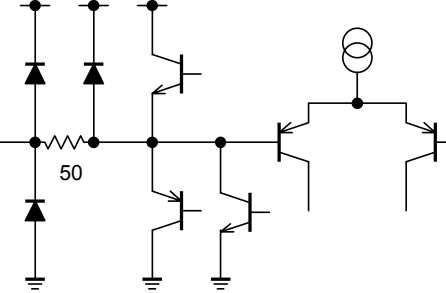
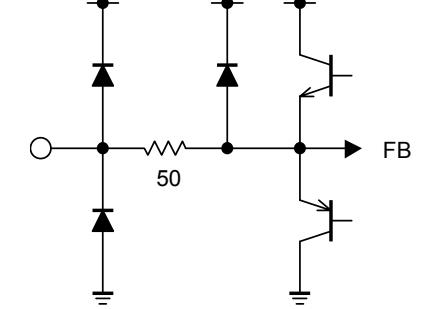
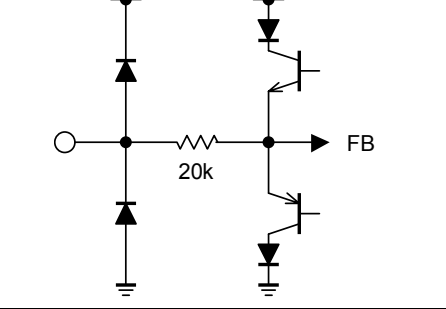
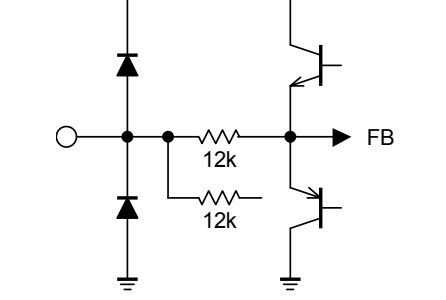
No.		SYMBOL	FUNCTION	EQUIVALENT CIRCUIT	VOLTAGE
SSOP32	SDIP30				
1 32	1 30	INa INb	Ach Input Bch Input		V+/2
2 3 30 31	2 3 28 29	BBE1a BBE2a BBE2b BBE1b	Ach BBE Filter1 (Process) Ach BBE Filter2 (Lo Contour) Bch BBE Filter2 (Process) Bch BBE Filter1 (Lo Contour)		V+/2
4 5	4 5	GOUT Vrefout	BBE Mach3BASS Filter BBE Mach3BASS Filter		V+/2
6 27	6 25	TONE-Ha TONE-Hb	Ach Treble Filter Bch Treble Filter		V+/2
7 26	7 24	TONE-La TONE-Lb	Ach Bass Filter Bch Bass Filter		V+/2

■ TERMINAL DESCRIPTION

No.		SYMBOL	FUNCTION	EQUIVALENT CIRCUIT	VOLTAGE
SSOP32	SDIP30				
9	8	OUTa OUTb	Ach Output Bch Output		V+/2
24	23				
10	9	AGC	AGC Filter		-
11	10	ADR	Slave address setting terminal		-
12	11	CBA	Pop Noise Reduction for Balance		-
13	12	CVO	Pop Noise Reduction for Volume		-



■ **TERMINAL DESCRIPTION**

No.		SYMBOL	FUNCTION	EQUIVALENT CIRCUIT	VOLTAGE
SSOP32	SDIP30				
14 15	13 14	SDA SCL	SDA Data Input (I <sup>2</sup> C BUS) SCL Data Input (I <sup>2</sup> C BUS)		-
16	15	GND	Ground Terminal	—	-
17	16	V+	Power Supply Terminal	—	-
18 19	17 18	AUX1 AUX0	Auxiliary Output 1 Auxiliary Output 0		0V / 5V
20 21	19 20	CTL CTH	Pop Noise reduction for Bass Control Pop Noise reduction for Treble Control		-

### ■ TERMINAL DESCRIPTION

No.		SYMBOL	FUNCTION	EQUIVALENT CIRCUIT	VOLTAGE
SSOP32	SDIP30				
22	21	VREF	Reference Voltage		V+/2
23	22	SR-FIL	Surround Filter		V+/2
28	26	LPOUT	BBE Mach3BASS Filter		V+/2
29	27	LPIN	BBE Mach3BASS Filter		V+/2

■ APPLICATION CIRCUIT 1 (SDIP30)

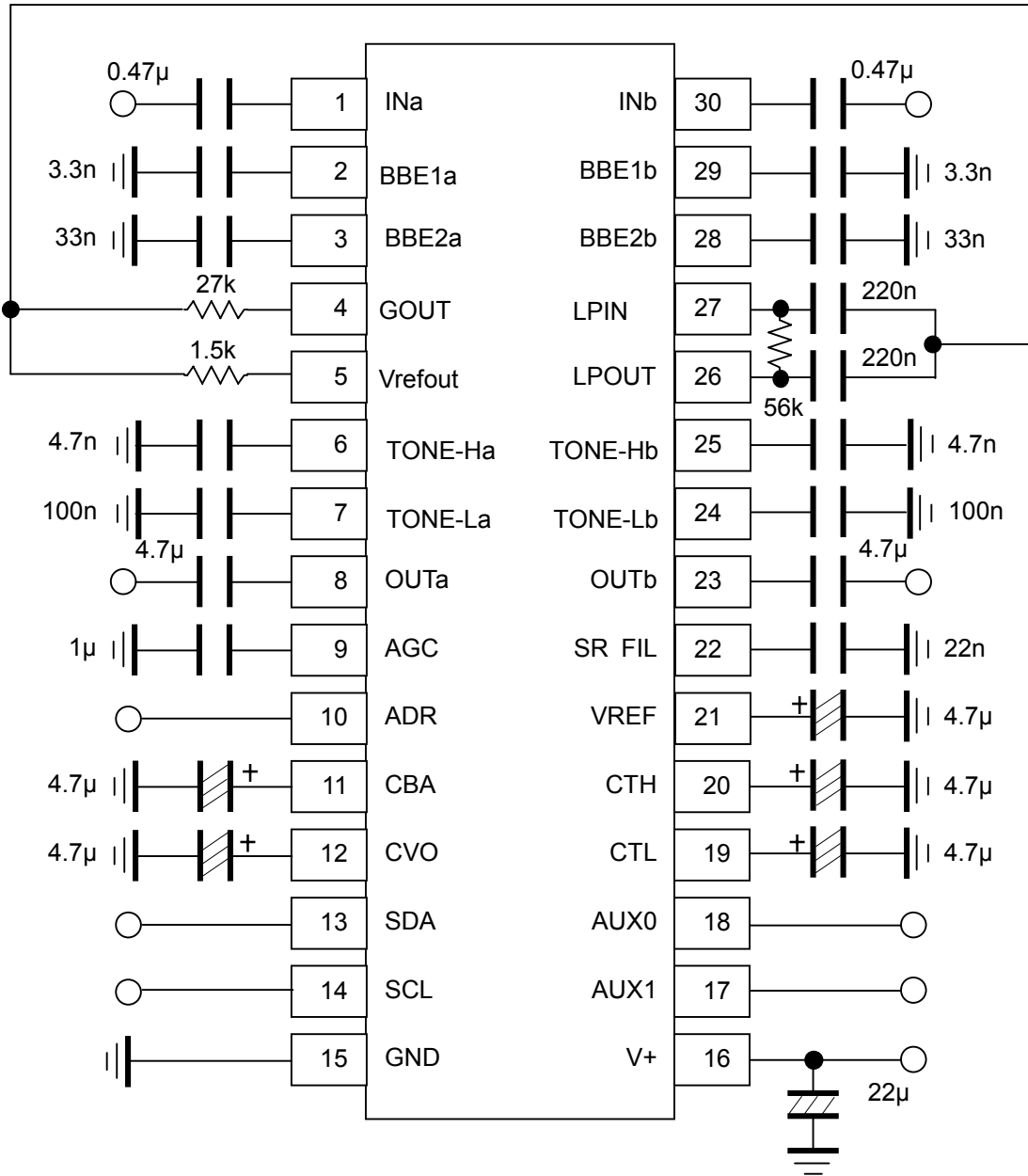

**(NOTE)**

1. Separate the I<sup>2</sup>C bus line from the following terminals for avoiding digital noise problem.

Pin No.	Symbol	Pin No.	Symbol	Pin No.	Symbol	Pin No.	Symbol	Pin No.	Symbol
2	BBE1a	6	TONE-Ha	22	SR-FIL	25	TONE-Hb	28	BBE2b
3	BBE2a	7	TONE-La	24	TONE-Lb	27	LPIN	29	BBE1b

2. The constant of capacitors connected to the terminals No.2, 3, 28 and 29 are designated by BBE Sound Inc. And the capacitor connected to the terminal No.22 fixes the BBE VIVA's effects. Do not change the constant of these capacitors without the approval of BBE Sound Inc.

## APPLICATION CIRCUIT 2 (SSOP32)

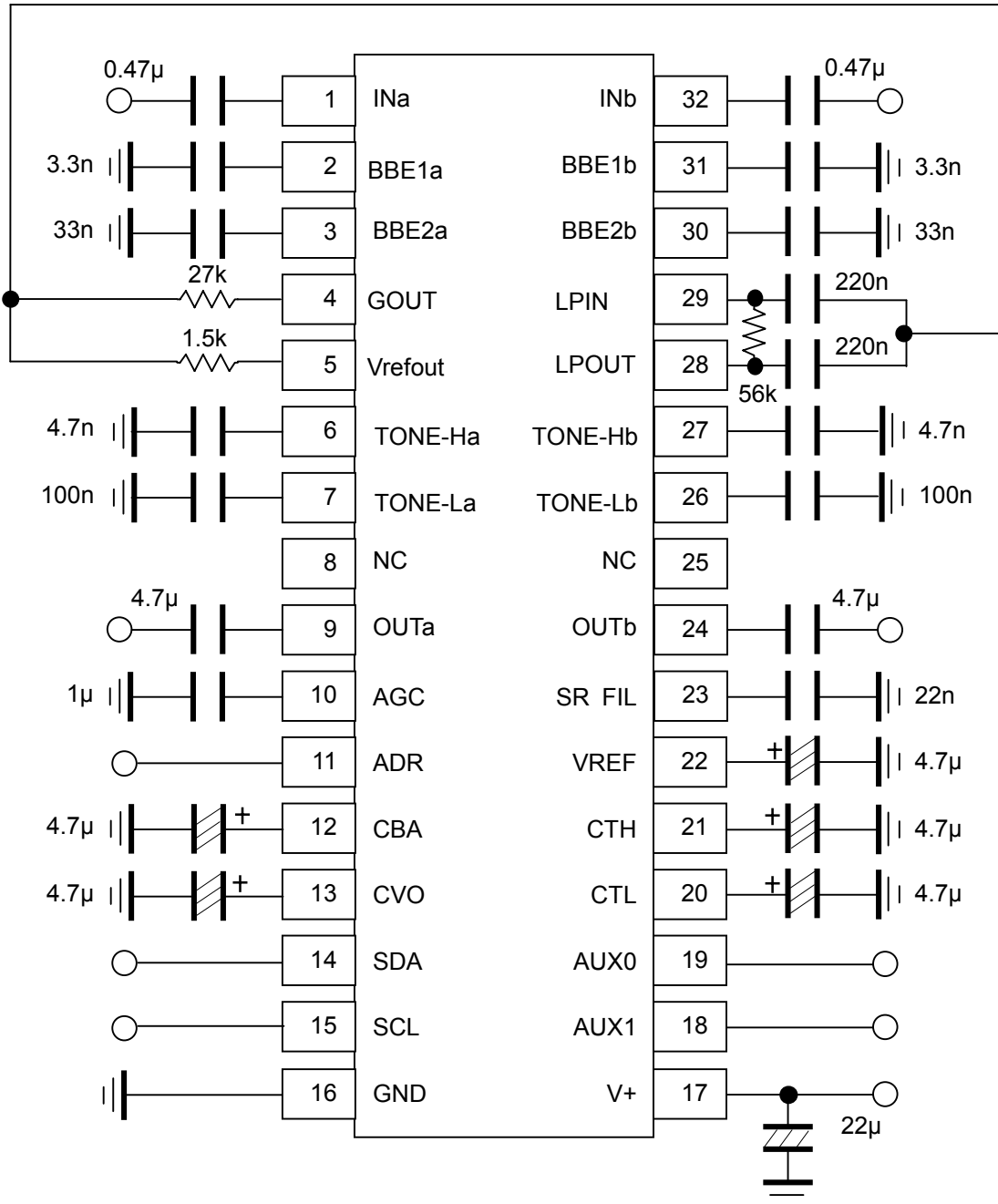

**(NOTE)**

1. Separate the I<sup>2</sup>C bus line from the following terminals for avoiding digital noise problem.

Pin No.	Symbol	Pin No.	Symbol	Pin No.	Symbol	Pin No.	Symbol	Pin No.	Symbol
2	BBE1a	6	TONE-Ha	24	SR-FIL	27	TONE-Hb	30	BBE2b
3	BBE2a	7	TONE-La	26	TONE-Lb	29	LPIN	31	BBE1b

2. The constant of capacitors connected to the terminals No.2, 3, 30 and 31 are designated by BBE Sound Inc. And the capacitor connected to the terminal No.24 fixes the BBE ViVA's effects. Do not change the constant of these capacitors without the approval of BBE Sound Inc.

## ■ DEFINITION OF I<sup>2</sup>C REGISTER

### ◆ I<sup>2</sup>C BUS FORMAT

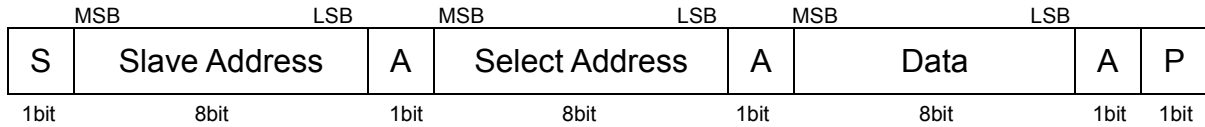

S: Starting Term

A: Acknowledge Bit

P: Ending Term

### ◆ SLAVE ADDRESS

MSB	1	0	0	0	0	0	1	R/W	LSB
MSB	1	0	0	0	0	1	0	R/W	LSB

82H(ADR=Low)

84H(ADR=High)

R/W=0: Receive Only

### ◆ CONTROL REGISTER TABLE

The select address sets each function (Volume, Balance, AGC, Surround, Tone Control, BBE, AUX).

The auto increment function cycles the select address as follows.

00H → 01H → 02H → 03H → 04H → 05H → 06H → 00H

Select Address	BIT							
	D7	D6	D5	D4	D3	D2	D1	D0
00H	VOL							
01H	CHS	BAL				AGC	SUR	
02H	BCB	BASS			BCSB	SUB-BASS		
03H	BCT	TREB			BCST	SUB-TREB		
04H	BBE (Lo Contour)				BBE (Process)			
05H	OUT	Don't care	Don't care	SUR0	AGC1	AGC0	AUX1	AUX0
06H	Mach3-BST				Don't Care	Don't Care	Don't Care	Don't Care

### ◆ CONTROL REGISTER DEFAULT VALUE

Control register default value is all "0".

Select Address	BIT							
	D7	D6	D5	D4	D3	D2	D1	D0
00H	0	0	0	0	0	0	0	0
01H	0	0	0	0	0	0	0	0
02H	0	0	0	0	0	0	0	0
03H	0	0	0	0	0	0	0	0
04H	0	0	0	0	0	0	0	0
05H	0	0	0	0	0	0	0	0
06H	0	0	0	0	0	0	0	0

■ INSTRUCTION CODE

a) MASTER VOLUME SETTINGS

Select Address	BIT							
	D7	D6	D5	D4	D3	D2	D1	D0
00H	VOL							

The volume control for both Ach and Bch (0.33dB/step).

The volume is consisted of volume1 and volume2 and the level is divided into half to each volume1 and volume2.

b) BALANCE, AGC AND SURROUND SETTINGS

Select Address	BIT							
	D7	D6	D5	D4	D3	D2	D1	D0
01H	CHS	BAL					AGC	SUR

- CHS: Channel select for balance control

“0”: Ach “Bch is attenuated”

“1”: Bch “Ach is attenuated”

- BAL: Balance control for both Ach and Bch (1dB/Step)

The balance is consisted of volume1 and volume2 and the level is divided into half to each volume1 and volume2.

- AGC: AGC switch

“0”: AGC OFF

“1”: AGC ON

- SUR: Surround mode switch

“0”: Surround OFF

“1”: Surround ON

NOTE) The click noise may be generated by changing the Surround mode setting.  
Provide the external circuit for avoiding the click noise on above condition.

c) TONE CONTROL BASS SETTINGS

Select Address	BIT							
	D7	D6	D5	D4	D3	D2	D1	D0
02H	BCB	BASS				BCSB	SUB-BASS	

- BCB: Boost cut select for Bass control

“0”: Cut

“1”: Boost

- BASS: BASS control

Cut Level : -15dB to 0dB(1dB/Step)

Boost Level : 0dB to +15dB(1dB/Step)

- BCSB: Boost cut select for SUB-BASS control

“0”: Cut

“1”: Boost

- SUB-BASS: SUB- BASS control (1dB/Step)

Sub-Cut Level : -3dB to 0dB(1dB/Step)

Sub-Boost Level : 0dB to +3dB(1dB/Step)

## d) TONE CONTROL TREBLE SETTINGS

Select Address	BIT								
	D7	D6	D5	D4	D3	D2	D1	D0	
03H	BCT	TREB				BCST	SUB-TREB		

- BCT: Boost cut select for Treble control  
"0": Cut  
"1": Boost
- TREB: Treble control (1dB/step)  
Cut Level : -15dB to 0dB(1dB/Step)  
Boost Level : 0dB to +15dB(1dB/Step)
- BCST: Boost cut select for Sub-Treble control  
"0": Cut  
"1": Boost
- SUB-TREB: Sub-Treble control (1dB/step)  
Sub-Cut Level : -3dB to 0dB(1dB/Step)  
Sub-Boost Level : 0dB to +3dB(1dB/Step)

## e) BBE BOOST LEVEL SETTINGS

Select Address	BIT							
	D7	D6	D5	D4	D3	D2	D1	D0
04H	BBE (Lo Contour)				BBE (Process)			

- BBE Lo Contour : 0dB to 15dB(1dB/step)
- BBE Process : 0dB to 15dB (1dB/step)

When all bits are "0"(=00H), BBE becomes off

NOTE) The click noise may be generated by changing the BBE setting.  
Provide the external circuit for avoiding the click noise on above condition.

## f) OUTPUT SWITCH, SURROUND LEVEL, AGC FLAT LEVEL AND AUXILIARY PORT SETTINGS

Select Address	BIT							
	D7	D6	D5	D4	D3	D2	D1	D0
05H	OUT	Don't Care	Don't Care	SUR0	AGC1	AGC0	AUX1	AUX0

- OUT: ON/OFF Switch for OUTPUT  
"0" : OFF  
"1" : ON

## •AGC Level Setting

AGC Level	AGC1(D3)	AGC0(D2)
150mVrms	0	0
300mVrms	0	1
400mVrms	1	0
540mVrms	1	1

## •Surround Setting

Surround Function	SUR0(05H:D4)	SUR(01H:D0)	Remarks
Surround OFF	0	0	Input through
BBE ViVA HD3D Sound	0	1	Set the BBE Boost Level
"eala"	1	1	NJRC original surround mode
Simulated Stereo	1	0	For monaural signal input only

- AUX1/AUX0: Auxiliary port High/Low  
"0": Logic output "Low"  
"1": Logic output "High"

### g) BBE Mach3BASS BOOST LEVEL SETTINGS

Select Address	BIT							
	D7	D6	D5	D4	D3	D2	D1	D0
06H	Mach3-BST				Don't Care	Don't Care	Don't Care	Don't Care

- Mach3-BST:Mach3BASS Boost Level Setting  
 "0" : OFF  
 "1" : ON  
 When all bits are "0"(=00H),BBE becomes off



## ■ MASTER VOLUME (Select Address: 00H)

		VOL							
Gain (dB)	HEX	D7	D6	D5	D4	D3	D2	D1	D0
0	FF	1	1	1	1	1	1	1	1
-1	FC	1	1	1	1	1	1	0	0
-2	F9	1	1	1	1	1	0	0	1
-3	F6	1	1	1	1	0	1	1	0
-4	F3	1	1	1	1	0	0	1	1
-5	F0	1	1	1	1	0	0	0	0
-6	ED	1	1	1	0	1	1	0	1
-7	EA	1	1	1	0	1	0	1	0
-8	E7	1	1	1	0	0	1	1	1
-9	E4	1	1	1	0	0	1	0	0
-10	E1	1	1	1	0	0	0	0	1
-11	DE	1	1	0	1	1	1	1	0
-12	DB	1	1	0	1	1	0	1	1
-13	D8	1	1	0	1	1	0	0	0
-14	D5	1	1	0	1	0	1	0	1
-15	D2	1	1	0	1	0	0	1	0
-16	CF	1	1	0	0	1	1	1	1
-17	CC	1	1	0	0	1	1	0	0
-18	C9	1	1	0	0	1	0	0	1
-19	C6	1	1	0	0	0	1	1	0
-20	C3	1	1	0	0	0	0	1	1
-21	C0	1	1	0	0	0	0	0	0
-22	BD	1	0	1	1	1	1	0	1
-23	BA	1	0	1	1	1	0	1	0
-24	B7	1	0	1	1	0	1	1	1
-25	B4	1	0	1	1	0	1	0	0
-26	B1	1	0	1	1	0	0	0	1
-27	AE	1	0	1	0	1	1	1	0
-28	AB	1	0	1	0	1	0	1	1
-29	A8	1	0	1	0	1	0	0	0
-30	A5	1	0	1	0	0	1	0	1
-31	A2	1	0	1	0	0	0	1	0
-32	9F	1	0	0	1	1	1	1	1
-33	9C	1	0	0	1	1	1	0	0
-34	99	1	0	0	1	1	0	0	1
-35	96	1	0	0	1	0	1	1	0
-36	93	1	0	0	1	0	0	1	1
-37	90	1	0	0	1	0	0	0	0
-38	8D	1	0	0	0	1	1	0	1
-39	8A	1	0	0	0	1	0	1	0
-40	87	1	0	0	0	0	1	1	1
-41	84	1	0	0	0	0	1	0	0
-42	81	1	0	0	0	0	0	0	1

■ MASTER VOLUME (Select Address: 00H)

		VOL							
Gain (dB)	HEX	D7	D6	D5	D4	D3	D2	D1	D0
-43	7E	0	1	1	1	1	1	1	0
-44	7B	0	1	1	1	1	0	1	1
-45	78	0	1	1	1	1	0	0	0
-46	75	0	1	1	1	0	1	0	1
-47	72	0	1	1	1	0	0	1	0
-48	6F	0	1	1	0	1	1	1	1
-49	6C	0	1	1	0	1	1	0	0
-50	69	0	1	1	0	1	0	0	1
-51	66	0	1	1	0	0	1	1	0
-52	63	0	1	1	0	0	0	1	1
-53	60	0	1	1	0	0	0	0	0
-54	5D	0	1	0	1	1	1	0	1
-55	5A	0	1	0	1	1	0	1	0
-56	57	0	1	0	1	0	1	1	1
-57	54	0	1	0	1	0	1	0	0
-58	51	0	1	0	1	0	0	0	1
-59	4E	0	1	0	0	1	1	1	0
-60	4B	0	1	0	0	1	0	1	1
-61	48	0	1	0	0	1	0	0	0
-62	45	0	1	0	0	0	1	0	1
-63	42	0	1	0	0	0	0	1	0
-64	3F	0	0	1	1	1	1	1	1
-65	3C	0	0	1	1	1	1	0	0
-66	39	0	0	1	1	1	0	0	1
-67	36	0	0	1	1	0	1	1	0
-68	33	0	0	1	1	0	0	1	1
-69	30	0	0	1	1	0	0	0	0
-70	2D	0	0	1	0	1	1	0	1
-71	2A	0	0	1	0	1	0	1	0
-72	27	0	0	1	0	0	1	1	1
-73	24	0	0	1	0	0	1	0	0
-74	21	0	0	1	0	0	0	0	1
-75	1E	0	0	0	1	1	1	1	0
-76	1B	0	0	0	1	1	0	1	1
-77	18	0	0	0	1	1	0	0	0
-78	15	0	0	0	1	0	1	0	1
-79	12	0	0	0	1	0	0	1	0
-80	0F	0	0	0	0	1	1	1	1
-81	0C	0	0	0	0	1	1	0	0
-82	09	0	0	0	0	1	0	0	1
-83	06	0	0	0	0	0	1	1	0
-84	03	0	0	0	0	0	0	1	1
Mute	00	0	0	0	0	0	0	0	0

## ■BALANCE (Select Address: 01H)

Channel Select (CHS)	D7
Ach (Bch is attenuated)	0
Bch (Ach is attenuated)	1

Gain (dB)	BAL				
	D6	D5	D4	D3	D2
0	0	0	0	0	0
-1	0	0	0	0	1
-2	0	0	0	1	0
-3	0	0	0	1	1
-4	0	0	1	0	0
-5	0	0	1	0	1
-6	0	0	1	1	0
-7	0	0	1	1	1
-8	0	1	0	0	0
-9	0	1	0	0	1
-10	0	1	0	1	0
-11	0	1	0	1	1
-12	0	1	1	0	0
-13	0	1	1	0	1
-14	0	1	1	1	0
-15	0	1	1	1	1
-16	1	0	0	0	0
-17	1	0	0	0	1
-18	1	0	0	1	0
-19	1	0	0	1	1
-20	1	0	1	0	0
-21	1	0	1	0	1
-22	1	0	1	1	0
-23	1	0	1	1	1
-24	1	1	0	0	0
-25	1	1	0	0	1
-26	1	1	0	1	0
-27	1	1	0	1	1
-28	1	1	1	0	0
-29	1	1	1	0	1
-30	1	1	1	1	0
Mute	1	1	1	1	1

■TONE CONTROL BASS (Select Address: 02H)

Bass Cut or Boost	BCB
	D7
Cut	0
Boost	1

		BASS			
		D6	D5	D4	D3
Cut Gain (dB)	Boost Gain (dB)				
-15	15	1	1	1	1
-14	14	1	1	1	0
-13	13	1	1	0	1
-12	12	1	1	0	0
-11	11	1	0	1	1
-10	10	1	0	1	0
-9	9	1	0	0	1
-8	8	1	0	0	0
-7	7	0	1	1	1
-6	6	0	1	1	0
-5	5	0	1	0	1
-4	4	0	1	0	0
-3	3	0	0	1	1
-2	2	0	0	1	0
-1	1	0	0	0	1
0	0	0	0	0	0

■TONE CONTROL SUB-BASS (Select Address: 02H)

Sub-Bass Cut or Boost	BCSB
	D2
Cut	0
Boost	1

		SUB-BASS	
		D1	D0
Cut Gain (dB)	Boost Gain (dB)		
-3	3	1	1
-2	2	1	0
-1	1	0	1
0	0	0	0

**■TONE CONTROL TREBLE (Select Address: 03H)**

Treble Cut or Boost	BCT
	D7
Cut	0
Boost	1

		TREB			
		D6	D5	D4	D3
Cut Gain (dB)	Boost Gain (dB)				
-15	15	1	1	1	1
-14	14	1	1	1	0
-13	13	1	1	0	1
-12	12	1	1	0	0
-11	11	1	0	1	1
-10	10	1	0	1	0
-9	9	1	0	0	1
-8	8	1	0	0	0
-7	7	0	1	1	1
-6	6	0	1	1	0
-5	5	0	1	0	1
-4	4	0	1	0	0
-3	3	0	0	1	1
-2	2	0	0	1	0
-1	1	0	0	0	1
0	0	0	0	0	0

**■TONE CONTROL SUB-TREBLE (Select Address : 03H)**

Sub-Treble Cut or Boost	BCST
	D2
Cut	0
Boost	1

		SUB-TREB	
		D1	D1
Cut Gain (dB)	Boost Gain (dB)		
-3	3	1	1
-2	2	1	0
-1	1	0	1
0	0	0	0

■BBE (Lo Contour) / (Process) Gain Code (Select Address: 04H)

Gain (dB)	Lo Contour				Process			
	D7	D6	D5	D4	D3	D2	D1	D0
15	1	1	1	1	1	1	1	1
14	1	1	1	0	1	1	1	0
13	1	1	0	1	1	1	0	1
12	1	1	0	0	1	1	0	0
11	1	0	1	1	1	0	1	1
10	1	0	1	0	1	0	1	0
9	1	0	0	1	1	0	0	1
8	1	0	0	0	1	0	0	0
7	0	1	1	1	0	1	1	1
6	0	1	1	0	0	1	1	0
5	0	1	0	1	0	1	0	1
4	0	1	0	0	0	1	0	0
3	0	0	1	1	0	0	1	1
2	0	0	1	0	0	0	1	0
1	0	0	0	1	0	0	0	1
0	0	0	0	0	0	0	0	0

■BBE Mach3BASS Gain Code (Select Address: 06H)

Gain (dB)	Mach3-BST			
	D7	D6	D5	D4
15	1	1	1	1
14	1	1	1	0
13	1	1	0	1
12	1	1	0	0
11	1	0	1	1
10	1	0	1	0
9	1	0	0	1
8	1	0	0	0
7	0	1	1	1
6	0	1	1	0
5	0	1	0	1
4	0	1	0	0
3	0	0	1	1
2	0	0	1	0
1	0	0	0	1
0	0	0	0	0

**TYPICAL CHARACTERISTICS**

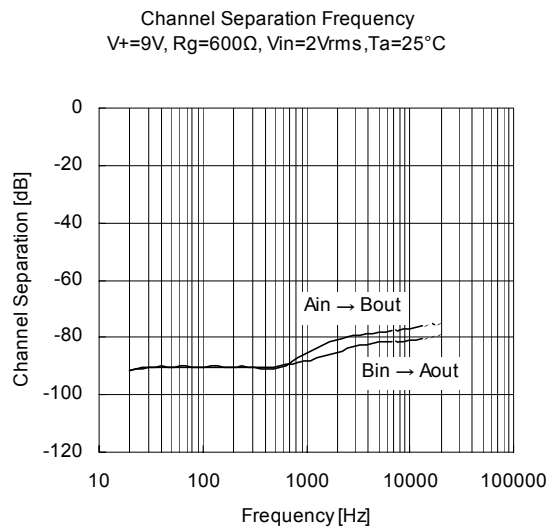
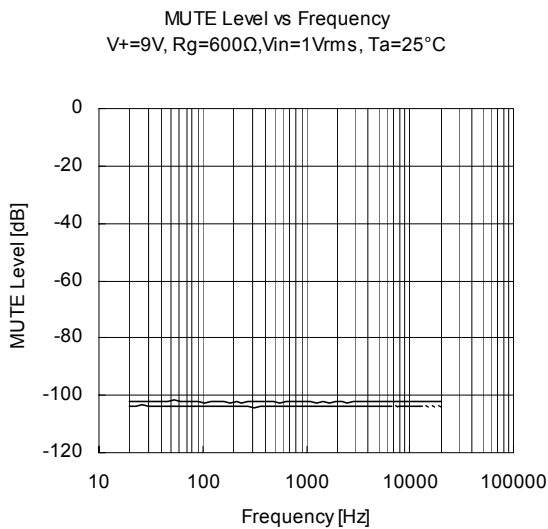
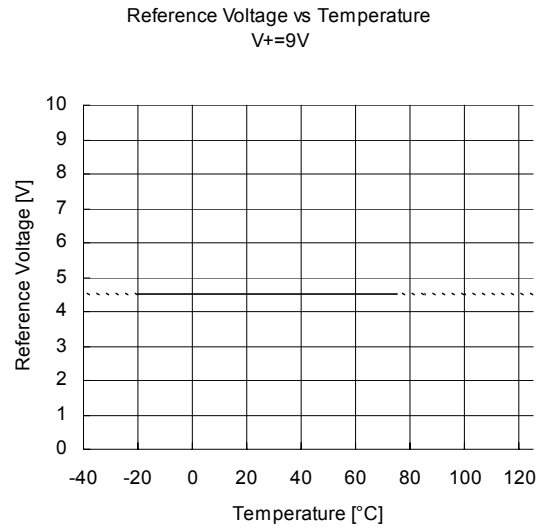
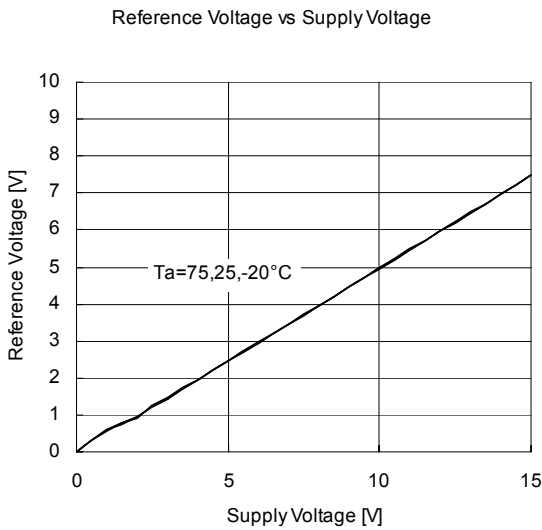
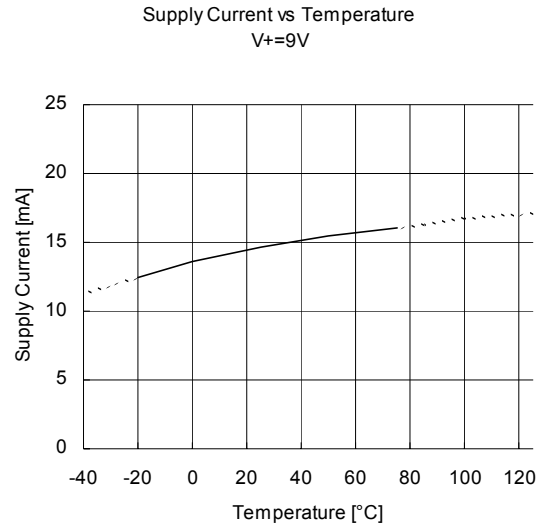
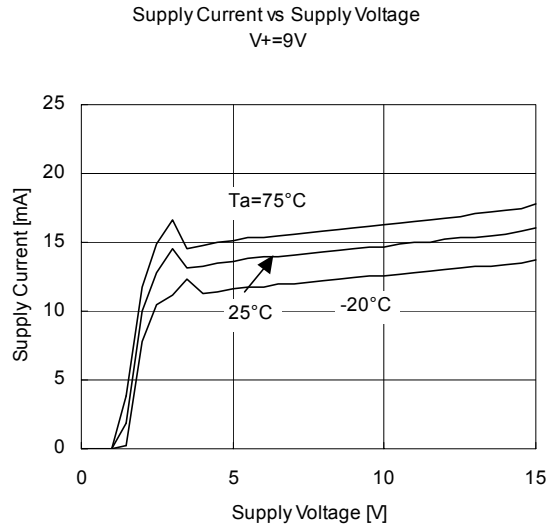

■ TYPICAL CHARACTERISTICS

Output Noise vs Temperature  
 $V_+ = 9V, R_g = 600\Omega, 400Hz-30kHz$

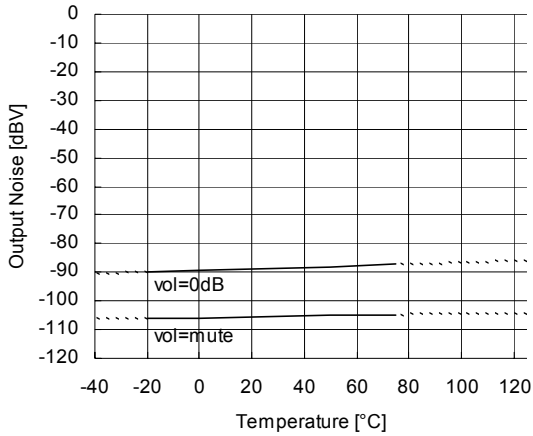

THD+N vs Input Voltage  
 $V_+ = 9V, V_{in} = I_{Na}, f = 1kHz, \text{volume} = 0dB$   
 $R_g = 600\Omega, BW = 400Hz-30kHz, V_o = OUTa$

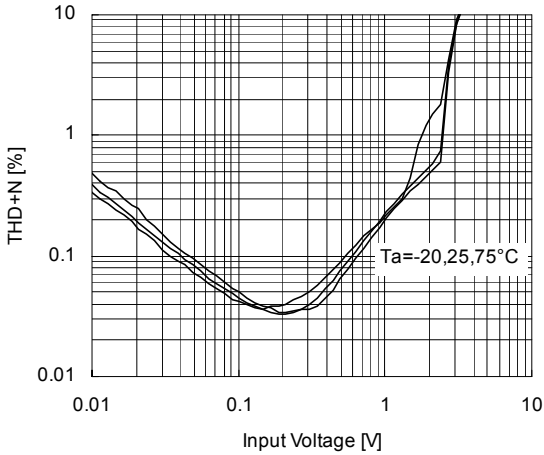

THD+N vs Input Voltage  
 $V_+ = 9V, V_{in} = I_{Na}, f = 1kHz, T_a = 25^\circ C$   
 $R_g = 600\Omega, BW = 400Hz-30kHz, V_o = OUTa$

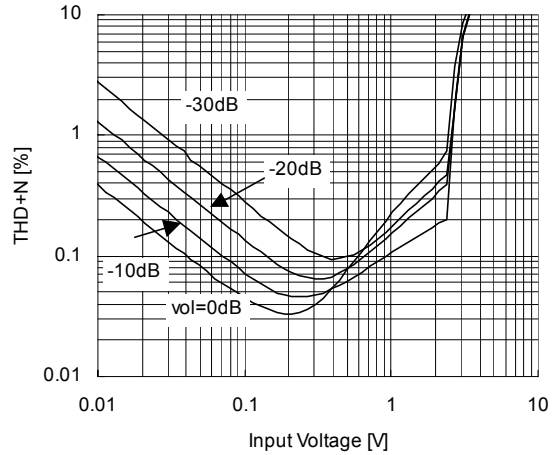

THD+N vs Output Voltage  
 $V_+ = 9V, V_{in} = I_{Na}, f = 1kHz, \text{volume} = 0dB$   
 $R_g = 600\Omega, BW = 400Hz-30kHz, V_o = OUTa$

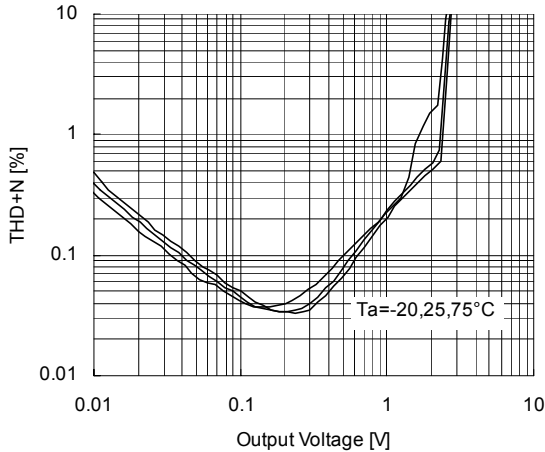

THD+N vs Output Voltage  
 $V_+ = 9V, V_{in} = I_{Na}, f = 1kHz, T_a = 25^\circ C$   
 $R_g = 600\Omega, BW = 400Hz-30kHz, V_o = OUTa$

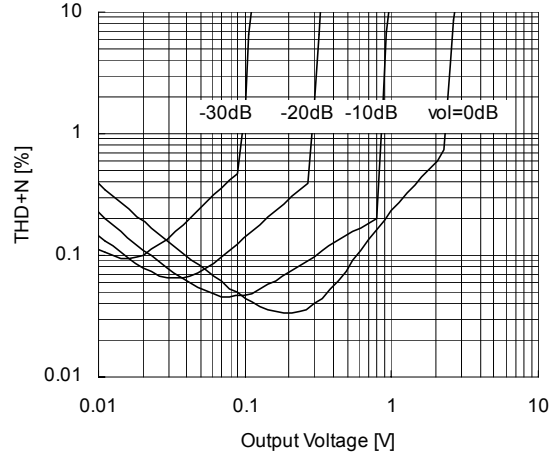



**TYPICAL CHARACTERISTICS**

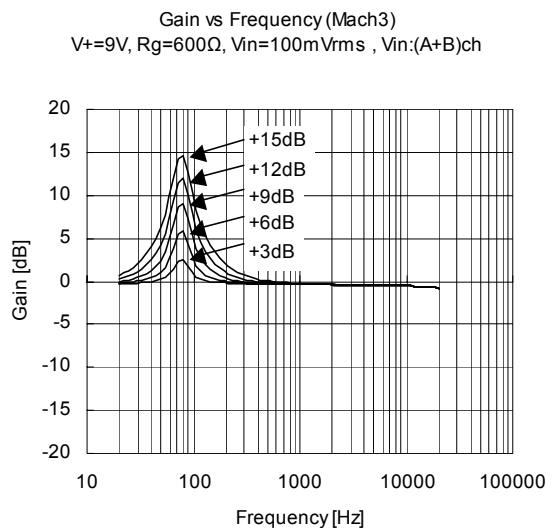
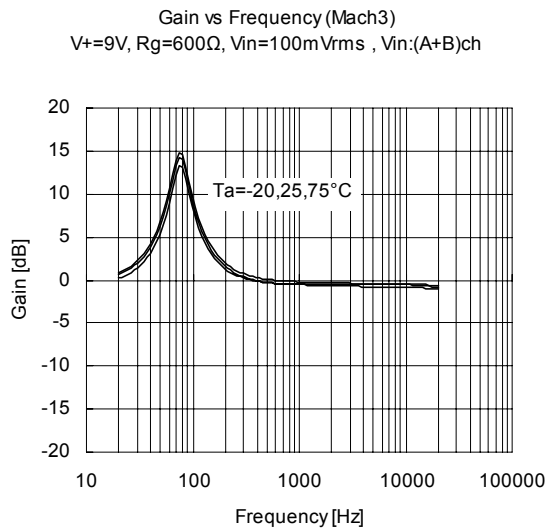
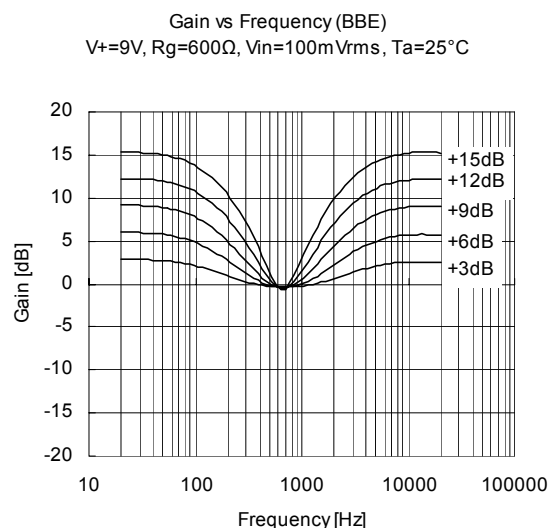
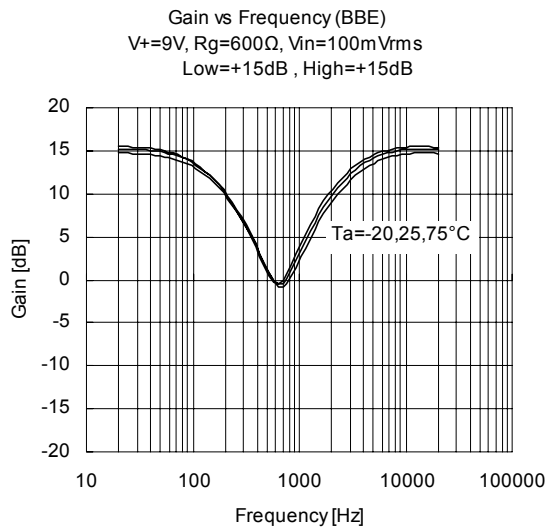
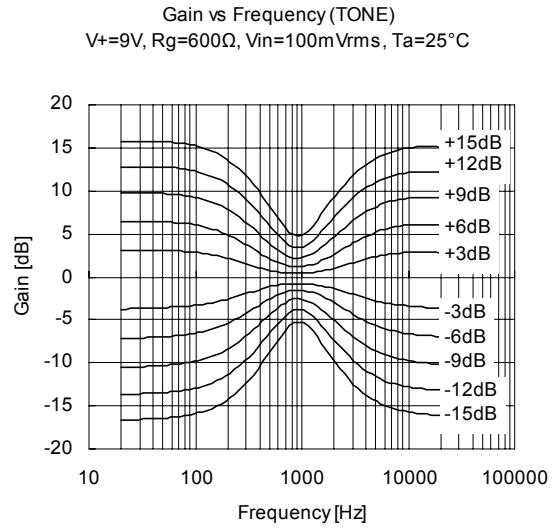
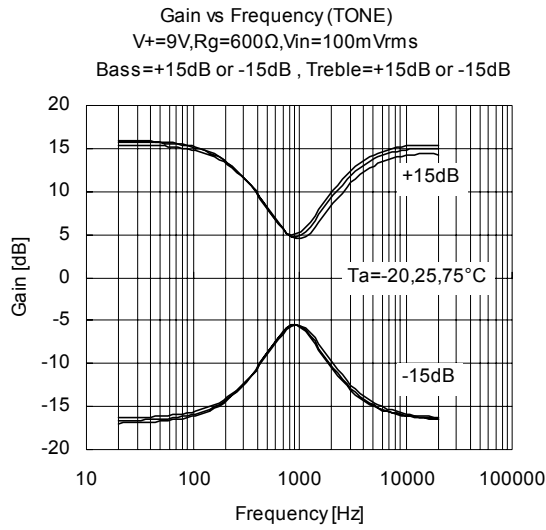

■ TYPICAL CHARACTERISTICS

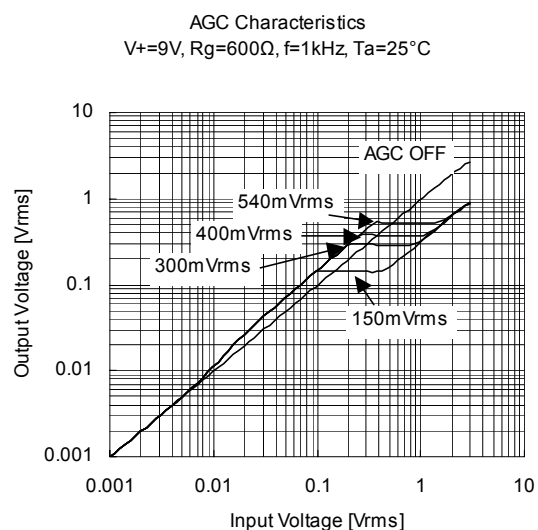
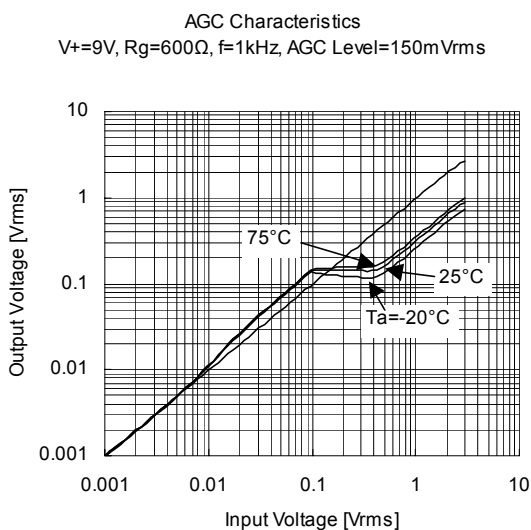
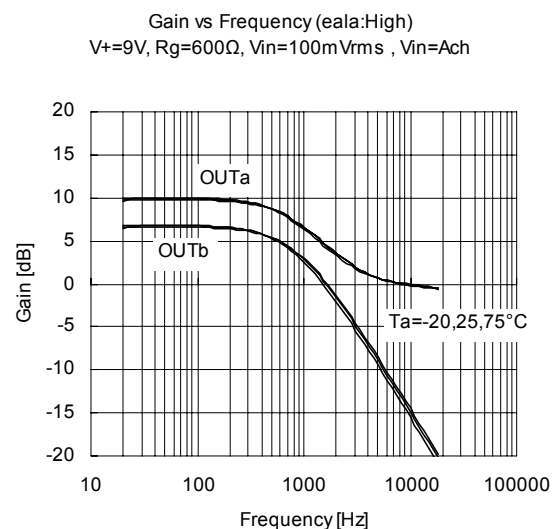
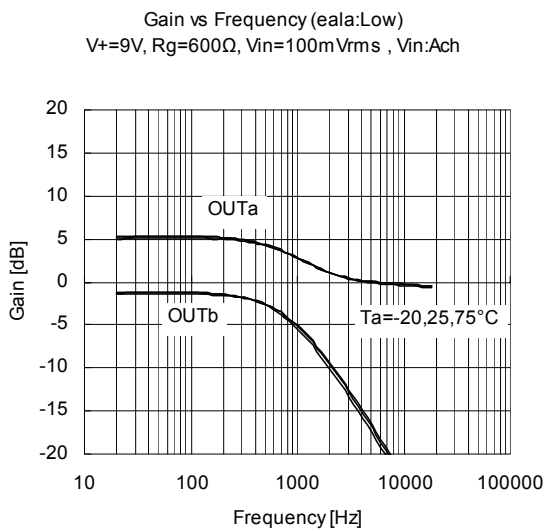
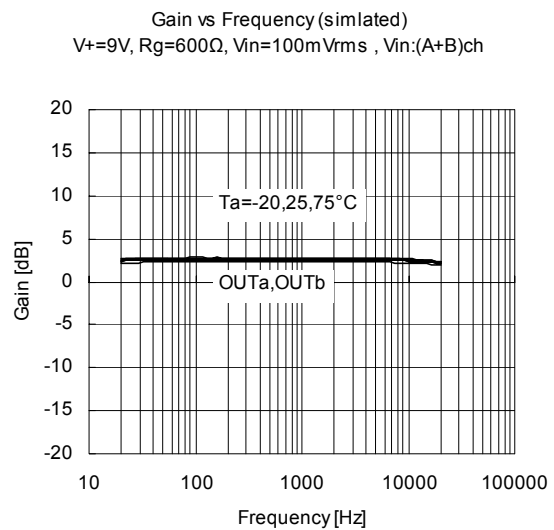
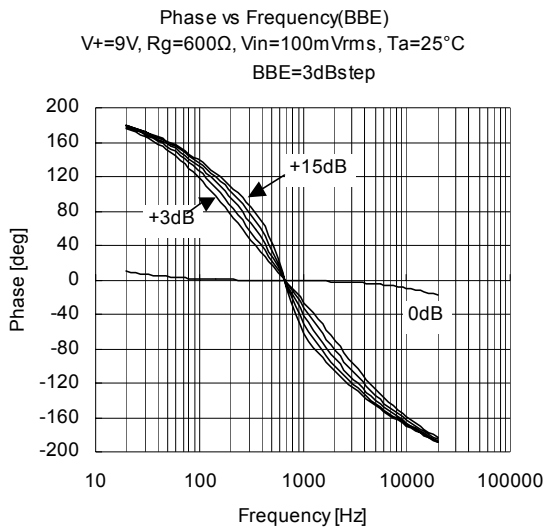

■ **TYPICAL CHARACTERISTICS**

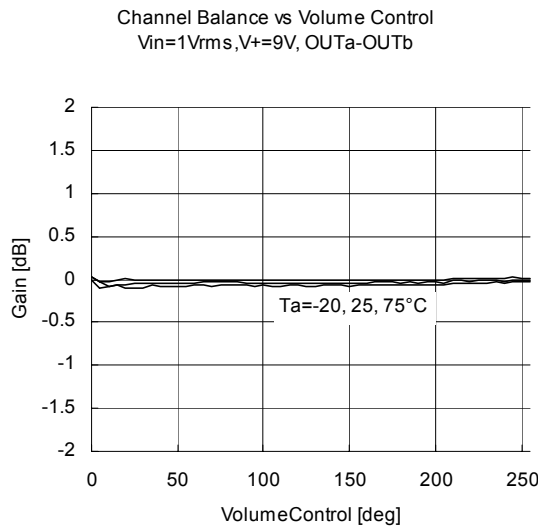
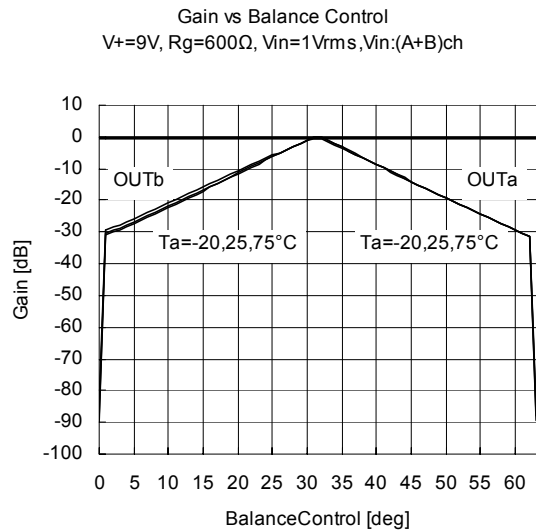
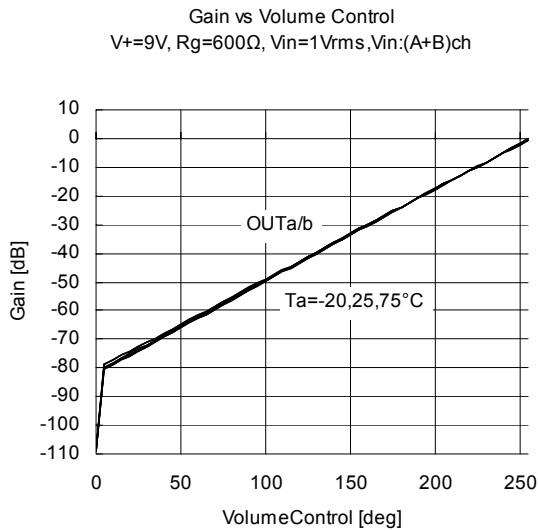
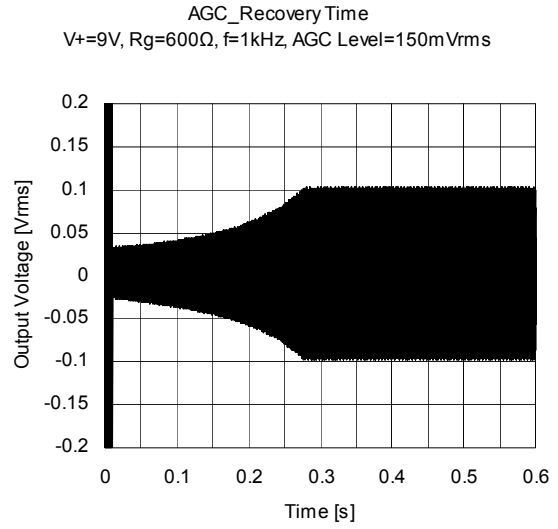
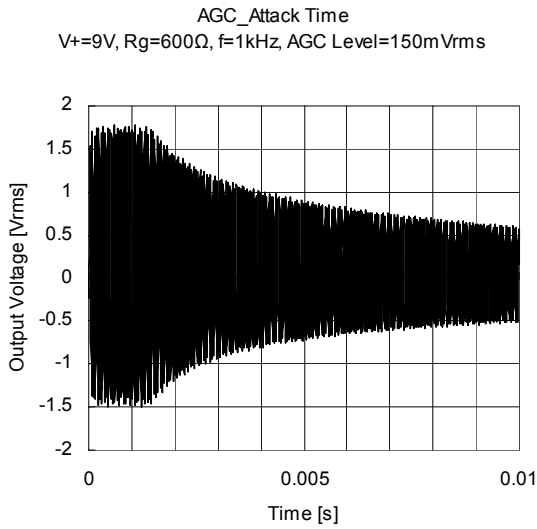

**[CAUTION]**  
 The specifications on this databook are only given for information, without any guarantee as regards either mistakes or omissions. The application circuits in this databook are described only to show representative usages of the product and not intended for the guarantee or permission of any right including the industrial rights.