



Audio Processor with SRS WOW

■ GENERAL DESCRIPTION

The **NJW1180** is an audio processor with SRS WOW. It includes all of functions processing audio signal for TV, such as volume, balance, tone control and 4ch input selector. All of internal status and variables are controlled by I²C BUS.

■ PACKAGE OUTLINE



NJW1180FP1

■ FEATURES

- Operating Voltage 8 to 13 V
- SRS WOW (including SRS 3D, FOCUS and TruBass function)
- Simulated Stereo
- 4ch Input Selector
- Volume 0 to -80dB (0.5dB/step), MUTE
- Balance 0 to -30dB (1dB/step), MUTE
- Tone Control -15dB to +15dB(1dB/step)
- I²C BUS Interface
- Bi-CMOS Technology
- Package Outline QFP48-P1

■ BLOCK DIAGRAM

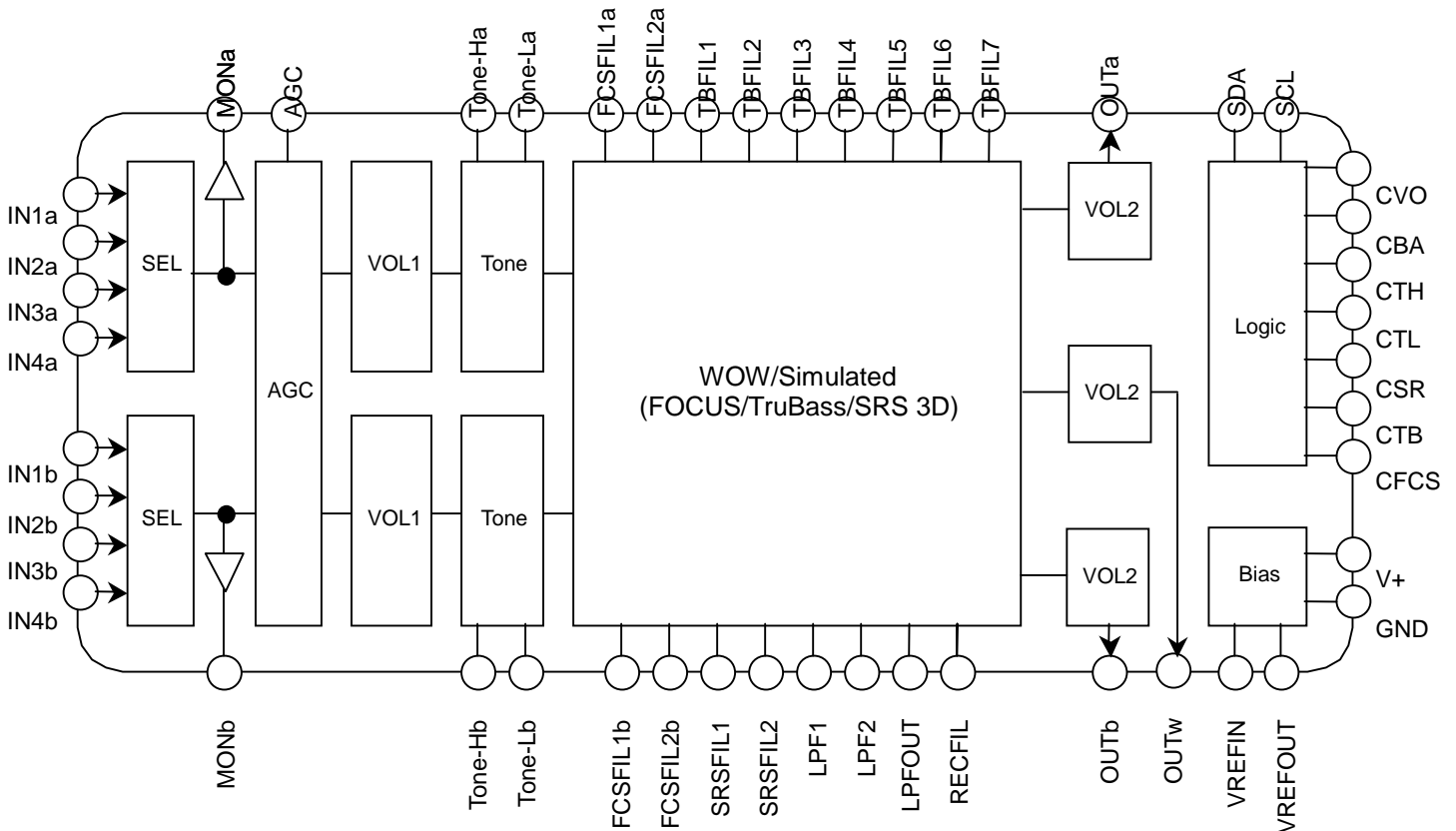

■ PIN FUNCTION

www.datasheet4u.com

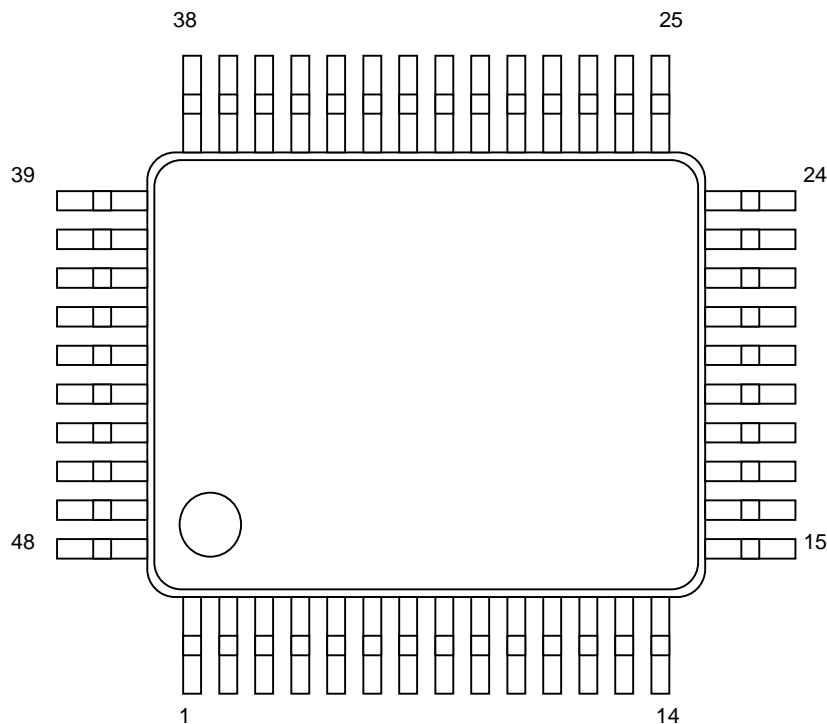

No.	SYMBOL	FUNCTION	No.	SYMBOL	FUNCTION
1	OUTw	Sub Woofer ch Output	25	OUTb	Bch Output
2	SRSFIL1	Surround Filter	26	TONE-Lb	Bch Bass Filter
3	CSR	Pop Noise Reduction for Surround ON/OFF	27	TONE-Hb	Bch Treble Filter
4	FCSFIL1a	Ach Focus Filter	28	MONb	Bch Monitor Output
5	FCSFIL2a	Ach Focus Filter	29	IN4b	Bch Input 4
6	CFCS	Pop Noise Reduction for Focus ON/OFF	30	IN3b	Bch Input 3
7	IN1a	Ach Input 1	31	IN2b	Bch Input 2
8	IN2a	Ach Input 2	32	IN1b	Bch Input 1
9	IN3a	Ach Input 3	33	AGC	AGC Filter
10	IN4a	Ach Input 4	34	FCSFIL2b	Bch Focus Filter
11	MONa	Ach Monitor Output	35	FCSFIL1b	Bch Focus Filter
12	TONE-Ha	Ach Treble Filter	36	CTB	Pop Noise Reduction for TruBass ON/OFF
13	TONE-La	Ach Bass Filter	37	SRSFIL2	Surround Filter
14	OUTa	Ach Output	38	RECFIL	Rectifier Filter
15	CTH	Pop Noise Reduction for Treble Control	39	TBFIL7	TruBass Filter
16	CTL	Pop Noise Reduction for Bass Control	40	TBFIL6	TruBass Filter
17	SDA	SDA Serial Data Input (I ² C BUS)	41	TBFIL5	TruBass Filter
18	SCL	SCL Serial Clock Input (I ² C BUS)	42	TBFIL4	TruBass Filter
19	GND	Ground	43	TBFIL3	TruBass Filter
20	V+	Power Supply	44	TBFIL2	TruBass Filter
21	VREFOUT	Reference Voltage Output	45	TBFIL1	TruBass Filter
22	VREFIN	Reference Voltage Input	46	LPFOUT	LPF Output
23	CVO	Pop Noise Reduction for Volume Control	47	LPF2	Low Pass Filter
24	CBA	Pop Noise Reduction for Balance Control	48	LPF1	Low Pass Filter

■ ABSOLUTE MAXIMUM RATING (Ta=25°C)

PARAMETER	SYMBOL	RATING	UNIT
Supply Voltage	V ⁺	15	V
Power Dissipation	P _D	1500(note)	mW
Operating Temperature Range	Topr	-20 to +75	°C
Storage Temperature Range	Tstg	-40 to +125	°C

(Note) At on a board of EIA/JEDEC specification. (76.2 x 114.3 x 1.6mm Two layers, FR-4)

■ ELECTRICAL CHARACTERISTICS

(Ta=25°C, V+=9V, Rg=600Ω, R_L=47kΩ, Vin=100mVrms/1kHz unless otherwise specified)

PARAMETER	SYMBOL	TEST CONDITION	MIN.	TYP.	MAX.	UNIT
Operating Voltage	V ⁺		8.0	9.0	13.0	V
Supply Current	I _{CC}	No Signal	-	20	35	mA
Reference Voltage	V _{REF}	No Signal	4.0	4.5	5.0	V
Maximum Input Voltage	V _{IM}	VOL=-20dB, THD=10%	2.8	3.0	-	Vrms
Maximum Output Voltage	V _{OM}	OUTPUT VOL=0dB, THD=1%	-	2.5	-	Vrms
Monitor Output Gain	G _{VMON}	MONOUT	-2.0	0.0	2.0	dB
Maximum Gain	G _{VMAX}	VOL= 0dB	-2.0	0.0	2.0	dB
Minimum Gain	G _{VMIN}	VOL= MUTE, Vin=2Vrms	-	-100	-90	dB
Channel Balance 1	G _{CB1}	VOL=0dB	-1.0	0.0	1.0	dB
Channel Balance 2	G _{CB2}	VOL=-70dB, Vin=1Vrms	-1.0	0.0	1.0	dB
Balance Boost A	BA _{BST}	CHS="0", BAL="11111"	-2.0	0.0	2.0	dB
Balance Cut A	BA _{CUT}	CHS="1", BAL="11111" Vin = 1Vrms	-	-	-70	dB
Balance Boost B	BB _{BST}	CHS="1", BAL="11111"	-2.0	0.0	2.0	dB
Balance Cut B	BB _{CUT}	CHS="0", BAL="11111" Vin = 1Vrms	-	-	-70	dB
Total Harmonic Distortion	THD	Vo=0.5Vrms BW=400Hz to 30kHz	-	-	0.5	%
Cross Talk 1	CT1	Input 1 = No signal Input 2/3/4 : Vin = 1Vrms SEL="00", A-weighting	-	-	-70	dB
Cross Talk 2	CT2	Input 2 = No signal Input 1/3/4 : Vin = 1Vrms SEL="01", A-weighting	-	-	-70	dB
Cross Talk 3	CT3	Input 3 = No signal Input 1/2/4 : Vin = 1Vrms SEL="10", A-weighting	-	-	-70	dB
Cross Talk 4	CT4	Input 4 = No signal Input 1/2/3 : Vin = 1Vrms SEL="11", A-weighting	-	-	-70	dB
Channel Separation	CS	Vin = 1Vrms A-weighting	-	-80	-70	dB
Output Noise 1	V _{NO1}	VOL = 0dB A-weighting	-	-90 (31.6)	-85 (56.2)	dBV (μVrms)
Output Noise 2	V _{NO2}	VOL = MUTE A-weighting	-	-106 (5.0)	-96 (15.8)	dBV (μVrms)

◆ TONE CONTROL

PARAMETER	SYMBOL	TEST CONDITION	MIN.	TYP.	MAX.	UNIT
High Frequency Boost	HF _{BST}	BCT="1", TREB="1111", f=10kHz	12.5	15.0	17.5	dB
High Frequency Flat	HF _{FLT}	TRBE="0000", f=10kHz	-2.0	0.0	2.0	dB
High Frequency Cut	HF _{CUT}	BCT="0", TRBE="1111", f=10kHz	-17.5	-15.0	-12.5	dB
Low Frequency Boost	LF _{BST}	BCB="1", BASS="1111", f=100Hz	12.5	15.0	17.5	dB
Low Frequency Flat	LF _{FLT}	BASS="0000", f=100Hz	-2.0	0.0	2.0	dB
Low Frequency Cut	LF _{CUT}	BCB="0", BASS="1111", f=100Hz	-17.5	-15.0	-12.5	dB

◆ AGC CONTROL

PARAMETER	SYMBOL	TEST CONDITION	MIN.	TYP.	MAX.	UNIT
AGC Boost	AGC _{BST}	AGC-FLAT = "300mVrms", Vin=50mVrms, f=1kHz	1.5	3.5	5.5	dB
AGC Flat1	AGC _{FLT1}	AGC-FLAT = "300mVrms", Vin=300mVrms, f=1kHz	-2.5	0.0	2.5	dB
AGC Flat2	AGC _{FLT2}	AGC-FLAT = "400mVrms", Vin=400mVrms, f=1kHz	-2.5	0.0	2.5	dB
AGC Flat3	AGC _{FLT3}	AGC-FLAT = "500mVrms", Vin=500mVrms, f=1kHz	-2.5	0.0	2.5	dB
AGC Flat4	AGC _{FLT4}	AGC-FLAT = "600mVrms", Vin=600mVrms, f=1kHz	-2.5	0.0	2.5	dB
AGC Cut	AGC _{CUT}	AGC-FLAT = "300mVrms", Vin=2Vrms, f=1kHz	-14	-10	-6.0	dB

◆ SURROUND

PARAMETER	SYMBOL	TEST CONDITION	MIN.	TYP.	MAX.	UNIT
FOCUS Gain1	G _{FCS1}	FCS="001", f=10kHz, Ain → Aout	1.0	3.0	5.0	dB
FOCUS Gain2	G _{FCS2}	FCS="010", f=10kHz, Ain → Aout	3.0	5.0	7.0	dB
FOCUS Gain3	G _{FCS3}	FCS="011", f=10kHz, Ain → Aout	5.5	7.5	9.5	dB
FOCUS Gain4	G _{FCS4}	FCS="100", f=10kHz, Ain → Aout	8.0	10.0	12.0	dB
TruBass Gain1	G _{TB1}	TB="001", f=100Hz, A+Bin → Aout	2.0	4.0	6.0	dB
TruBass Gain2	G _{TB2}	TB="010", f=100Hz, Ain+Bin → Aout	4.0	6.0	8.0	dB
TruBass Gain3	G _{TB3}	TB="011", f=100Hz, Ain+Bin → Aout	7.0	9.0	11.0	dB
TruBass Gain4	G _{TB4}	TB="100", f=100Hz, Ain+Bin → Aout	13.0	15.0	17.0	dB
Simulated Stereo Gain	G _{SIM1}	SUR="001", f=1kHz, Ain+Bin → Aout	1.0	3.0	5.0	dB
SRS Gain1	G _{SRS1}	SUR="010", f=1kHz, Ain → Aout	2.5	4.5	6.5	dB
SRS Gain2	G _{SRS2}	SUR="011", f=1kHz, Ain → Aout	5.0	7.0	9.0	dB
SRS Gain3	G _{SRS3}	SUR="100", f=1kHz, Ain → Aout	7.0	9.0	11.0	dB
SRS Gain4	G _{SRS4}	SUR="101", f=1kHz, Ain → Aout	9.5	11.5	13.5	dB

■ I²C BUS CHARACTERISTICS (SDA, SCL)

I²C BUS Load Conditions: Pull up resistance 4k (Connected to +5V), Load capacitance 200pF (Connected to GND)

PARAMETER	SYM BOL	STANDARD MODE			FAST MODE			UNIT
		MIN.	TYP.	MAX.	MIN.	TYP.	MAX.	
Low Level Input Voltage	V _{IL}	0.0	-	1.5	0.0	-	1.5	V
High Level Input Voltage	V _{IH}	2.7	-	5.0	2.7	-	5.0	V
Hysteresis of Schmitt trigger inputs	V _{hys}	-	-	-	0.25	-	-	V
LOW level output voltage (3mA at SDA pin)	V _{OL}	0	-	0.4	0	-	0.4	V
Output fall time from V _{IHmin} to V _{ILmax} with a bus capacitance from 10pF to 400pF	t _{of}	-	-	250	20 +0.1C _b	-	250	ns
Pulse width of spikes which must be suppressed by the input filter	t _{SP}	-	-	-	0	-	50	ns
Input current each I/O pin with an input voltage between 0.1V _{DD} and 0.9V _{DDmax}	I _i	-10	-	10	-10	-	10	μA
Capacitance for each I/O pin	C _i	-	-	10	-	-	10	pF
SCL clock frequency	f _{SCL}	-	-	100	-	-	400	kHz
Hold time (repeated) START condition.	t _{HD:STA}	4.0	-	-	0.6	-	-	μs
LOW period of the SCL clock	t _{LOW}	4.7	-	-	1.3	-	-	μs
HIGH period of the SCL clock	t _{HIGH}	4.0	-	-	0.6	-	-	μs
Set-up time for a repeated START condition	t _{SU:STA}	4.7	-	-	0.6	-	-	μs
Data hold time	t _{HD:DAT}	0	-	3.45	0	-	0.9	μs
Data set-up time	t _{SU:DAT}	250	-	-	100	-	-	ns
Rise time of both SDA and SCL signals	t _r	-	-	1000	-	-	300	ns
Fall time of both SDA and SCL signals	t _f	-	-	300	-	-	300	ns
Set-up time for STOP condition	t _{SU:STO}	4.0	-	-	0.6	-	-	μs
Bus free time between a STOP and START condition	t _{BUF}	4.7	-	-	1.3	-	-	μs
Capacitive load for each bus line	C _b	-	-	400	-	-	400	pF
Noise margin at the LOW level	V _{nL}	0.5	-	-	0.5	-	-	V
Noise margin at the HIGH level	V _{nH}	1	-	-	1	-	-	V

C_b ; total capacitance of one bus line in pF.

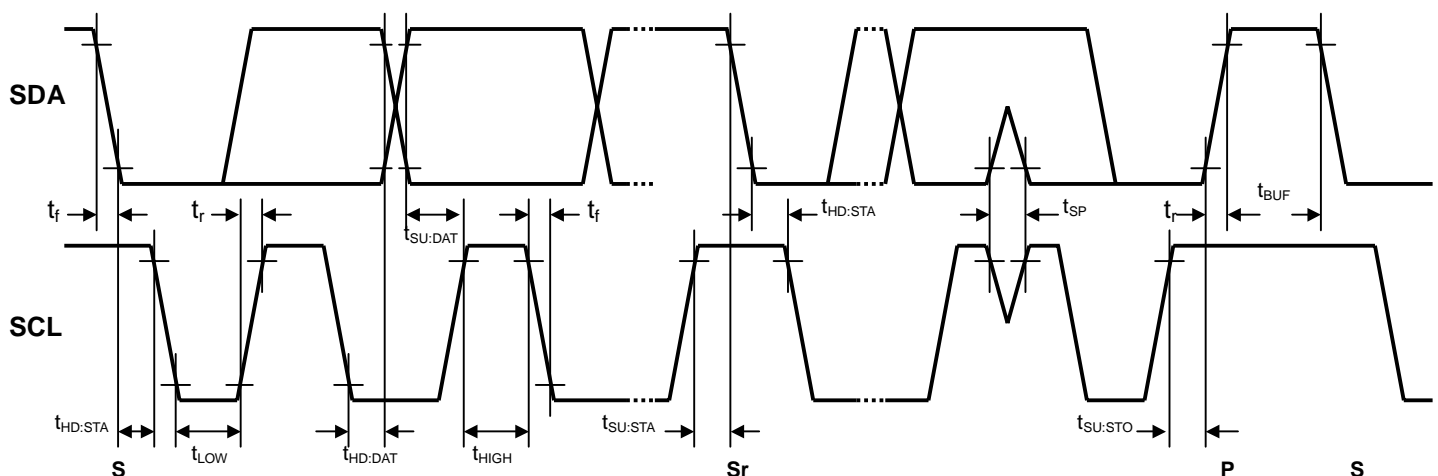

APPLICATION CIRCUIT

www.datasheet4u.com

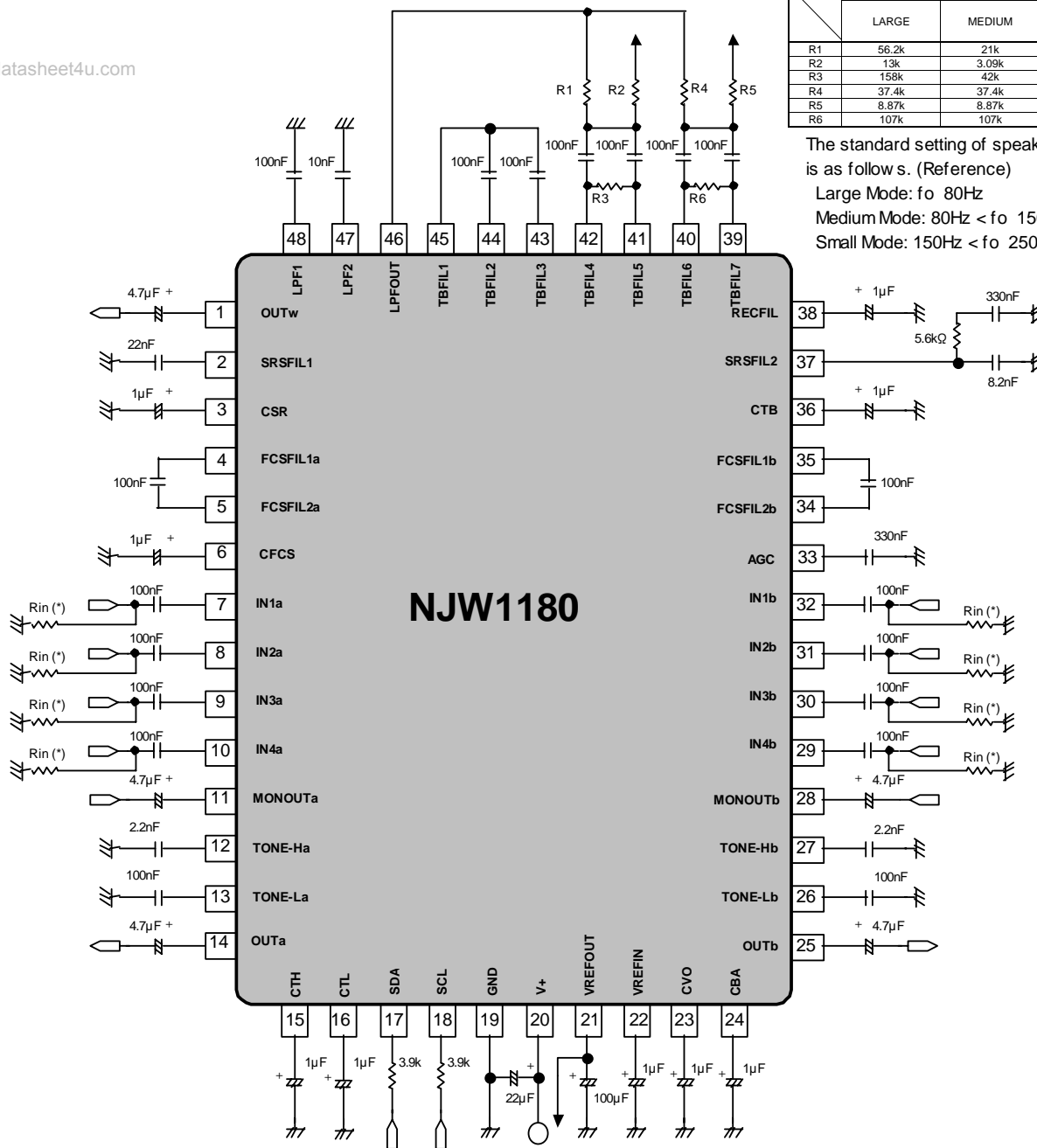

(*) Separate the I²C bus line and Signal line from the following terminals for avoiding digital noise problem and cross talk.

Pin No.	Symbol	Pin No.	Symbol	Pin No.	Symbol	Pin No.	Symbol
2	SRSFIL1	26	TONE-Lb	39	TBFIL7	44	TBFIL2
4	FCSFIL1a	27	TONE-Hb	40	TBFIL6	45	TBFIL1
5	FCSFIL2a	34	FCSFIL2b	41	TBFIL5	46	LPFOUT
12	TONE-Ha	35	FCSFIL1b	42	TBFIL4	47	LPF2
13	TONE-La	37	SRSFIL2	43	TBFIL3	48	LPF1

(*) Cross talk performance may be effected by PCB patterning and Input resistor "Rin" in relation to input impedance. Widen intervals of input lines (7pin to 10pin, 29pin to 32pin) and put guard patterns (ground patterns) among input lines and Monitor outputs (11pin, 28pin) and Tone filters (12pin, 13pin, 26pin, 27pin) for avoiding cross talk problem. Further, cross talk performance may be effected by input resistor "Rin". The recommended "Rin" value is 20kΩ or less. In consideration of an actual operating condition, please decide Rin values after evaluating. (The NJW1180 input impedances are 100kΩtyp.)

■ DEFINITION OF I²C REGISTER

● I²C BUS FORMAT

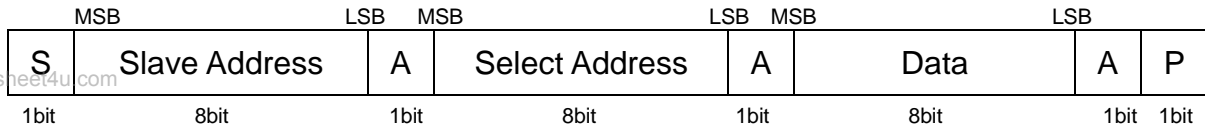

S: Starting Term
 A: Acknowledge Bit
 P: Ending Term

● SLAVE ADDRESS

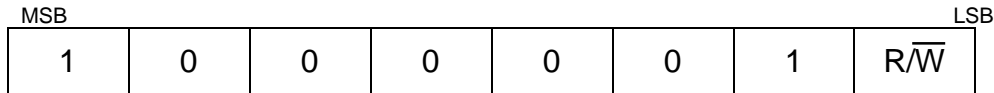

R/W=0: Write mode for register setting
 R/W=1: Not available

● CONTROL REGISTER TABLE

The select address sets each function (Volume, Balance, AGC, Tone Control, Surround etc.).
 The auto-increment function cycles the select address as follows.
 00H → 01H → 02H → 03H → 04H → 00H

Select Address	BIT							
	D7	D6	D5	D4	D3	D2	D1	D0
00H	VOL							
01H	CHS	BAL					SEL	
02H	BCB	BASS				AGC-SW	AGC-FLAT	
03H	BCT	TREB				FCS		
04H	MODE	TB			SUR			Don't Care

● CONTROL REGISTER DEFAULT VALUE

Control register default value is all "0".

Select Address	BIT							
	D7	D6	D5	D4	D3	D2	D1	D0
00H	0	0	0	0	0	0	0	0
01H	0	0	0	0	0	0	0	0
02H	0	0	0	0	0	0	0	0
03H	0	0	0	0	0	0	0	0
04H	0	0	0	0	0	0	0	0

■ I²C CONTROL COMMAND DESCRIPTION

● MASTER VOLUME CONTROL

Select Address	BIT							
	D7	D6	D5	D4	D3	D2	D1	D0
00H	VOL							

The volume controls both Ach and Bch by the 0.5dB step.

The volume is consisted of volume1 and volume2. The level is divided into half to each volume1 and volume2.

● BALANCE, AGC AND INPUT SELECTOR SETTINGS

Select Address	BIT							
	D7	D6	D5	D4	D3	D2	D1	D0
01H	CHS	BAL					SEL	

- CHS: Channel select for balance control
 "0": Ach "Bch is attenuated"
 "1": Bch "Ach is attenuated"
- BAL: Balance control for both Ach and Bch (1dB/Step)
- SEL: Input Selector

Input Select	SEL	
	D1	D0
IN1a and IN1b	0	0
IN2a and IN2b	0	1
IN3a and IN3b	1	0
IN4a and IN4b	1	1

● TONE CONTROL (Bass) and AGC SETTINGS

Select Address	BIT							
	D7	D6	D5	D4	D3	D2	D1	D0
02H	BCB	BASS				AGC-SW	AGC-FLAT	

- BCB : Bass Boost or Cut
 "0" : Cut
 "1" : Boost
- BASS : BASS Level
 Cut Level : -15 to 0dB(1dB/Step)
 Boost Level : 0 to +15dB(1dB/Step)
- AGC-SW : AGC ON/OFF Switch
 "0" : AGC OFF
 "1" : AGC ON (Default : 300mVrms)
- AGC-FLAT : AGC Flat Level

AGC Flat Level	AGC-FLAT	
	D1	D0
300mVrms	0	0
400mVrms	0	1
500mVrms	1	0
600mVrms	1	1

●TONE CONTROL (Treble) and FOCUS EFFECT SETTINGS

Select Address	BIT							
	D7	D6	D5	D4	D3	D2	D1	D0
03H	BCT	TREB				FCS		

- BCT : Treble Boost or Cut
 "0" : Cut
 "1" : Boost
- TREB : Treble Level
 Cut Level : -15 to 0dB(1dB/Step)
 Boost Level : 0 to +15dB(1dB/Step)

- FCS: FOCUS Effect

FOCUS Effect	FCS		
	D2	D1	D0
OFF	0	0	0
Effect 1 (Minimum)	0	0	1
Effect 2	0	1	0
Effect 3	0	1	1
Effect 4 (Maximum)	1	Don't Care	Don't Care

● WOW Output Mode Select, TruBass and Surround EFFECT SETTINGS

Select Address	BIT							
	D7	D6	D5	D4	D3	D2	D1	D0
04H	MODE	TB			SUR			Don't Care

- MODE : Output Mode Select

MODE	D7	Output terminals
2ch	0	OUTa(14pin), OUTb(25pin)
2.1ch	1	OUTa(14pin), OUTb(25pin), OUTw(1pin)

- TB : TruBass Effect

TruBass Effect	TB		
	D6	D5	D4
OFF	0	0	0
Effect 1 (Minimum)	0	0	1
Effect 2	0	1	0
Effect 3	0	1	1
Effect 4 (Maximum)	1	Don't Care	Don't Care

NOTE)

	MODE=2ch		MODE=2.1ch	
	TB=OFF	TB=Effect1-4	TB=OFF	TB=Effect1-4
OUTa(14pin), OUTb(25pin)	Bypass *)	TB effect (WOW)	Bypass *)	
OUTw(1pin)	No Output		No Output	TB effect

*) TruBass is not effective.

•SUR : Surround Effect

Surround Effect	SUR		
	D3	D2	D1
OFF	0	0	0
Simulated Stereo ^(NOTE)	0	0	1
Effect 1 (Minimum)	0	1	0
Effect 2	0	1	1
Effect 3	1	0	0
Effect 4 (Maximum)	1	0	1
	1	1	Don't Care

NOTE) Simulated Stereo dose not adapt to SRS WOW.

■ Master Volume (Select Address: 00H)

		VOL							
Gain(dB)	HEX	D7	D6	D5	D4	D3	D2	D1	D0
0	FF	1	1	1	1	1	1	1	1
-1	FD	1	1	1	1	1	1	0	1
-2	FB	1	1	1	1	1	0	1	1
-3	F9	1	1	1	1	1	0	0	1
-4	F7	1	1	1	1	0	1	1	1
-5	F5	1	1	1	1	0	1	0	1
-6	F3	1	1	1	1	0	0	1	1
-7	F1	1	1	1	1	0	0	0	1
-8	EF	1	1	1	0	1	1	1	1
-9	ED	1	1	1	0	1	1	0	1
-10	EB	1	1	1	0	1	0	1	1
-11	E9	1	1	1	0	1	0	0	1
-12	E7	1	1	1	0	0	1	1	1
-13	E5	1	1	1	0	0	1	0	1
-14	E3	1	1	1	0	0	0	1	1
-15	E1	1	1	1	0	0	0	0	1
-16	DF	1	1	0	1	1	1	1	1
-17	DD	1	1	0	1	1	1	0	1
-18	DB	1	1	0	1	1	0	1	1
-19	D9	1	1	0	1	1	0	0	1
-20	D7	1	1	0	1	0	1	1	1
-21	D5	1	1	0	1	0	1	0	1
-22	D3	1	1	0	1	0	0	1	1
-23	D1	1	1	0	1	0	0	0	1
-24	CF	1	1	0	0	1	1	1	1
-25	CD	1	1	0	0	1	1	0	1
-26	CB	1	1	0	0	1	0	1	1
-27	C9	1	1	0	0	1	0	0	1
-28	C7	1	1	0	0	0	1	1	1
-29	C5	1	1	0	0	0	1	0	1
-30	C3	1	1	0	0	0	0	1	1
-31	C1	1	1	0	0	0	0	0	1
-32	BF	1	0	1	1	1	1	1	1
-33	BD	1	0	1	1	1	1	0	1
-34	BB	1	0	1	1	1	0	1	1
-35	B9	1	0	1	1	1	0	0	1
-36	B7	1	0	1	1	0	1	1	1
-37	B5	1	0	1	1	0	1	0	1
-38	B3	1	0	1	1	0	0	1	1
-39	B1	1	0	1	1	0	0	0	1
-40	AF	1	0	1	0	1	1	1	1
-41	AD	1	0	1	0	1	1	0	1
-42	AB	1	0	1	0	1	0	1	1

■MASTER VOLUME (Cont'd)

		VOL							
Gain(dB)	HEX	D7	D6	D5	D4	D3	D2	D1	D0
-43	A9	1	0	1	0	1	0	0	1
-44	A7	1	0	1	0	0	1	1	1
-45	A5	1	0	1	0	0	1	0	1
-46	A3	1	0	1	0	0	0	1	1
-47	A1	1	0	1	0	0	0	0	1
-48	9F	1	0	0	1	1	1	1	1
-49	9D	1	0	0	1	1	1	0	1
-50	9B	1	0	0	1	1	0	1	1
-51	99	1	0	0	1	1	0	0	1
-52	97	1	0	0	1	0	1	1	1
-53	95	1	0	0	1	0	1	0	1
-54	93	1	0	0	1	0	0	1	1
-55	91	1	0	0	1	0	0	0	1
-56	8F	1	0	0	0	1	1	1	1
-57	8D	1	0	0	0	1	1	0	1
-58	8B	1	0	0	0	1	0	1	1
-59	89	1	0	0	0	1	0	0	1
-60	87	1	0	0	0	0	1	1	1
-61	85	1	0	0	0	0	1	0	1
-62	83	1	0	0	0	0	0	1	1
-63	81	1	0	0	0	0	0	0	1
-64	7F	0	1	1	1	1	1	1	1
-65	7D	0	1	1	1	1	1	0	1
-66	7B	0	1	1	1	1	0	1	1
-67	79	0	1	1	1	1	0	0	1
-68	77	0	1	1	1	0	1	1	1
-69	75	0	1	1	1	0	1	0	1
-70	73	0	1	1	1	0	0	1	1
-71	71	0	1	1	1	0	0	0	1
-72	6F	0	1	1	0	1	1	1	1
-73	6D	0	1	1	0	1	1	0	1
-74	6B	0	1	1	0	1	0	1	1
-75	69	0	1	1	0	1	0	0	1
-76	67	0	1	1	0	0	1	1	1
-77	65	0	1	1	0	0	1	0	1
-78	63	0	1	1	0	0	0	1	1
-79	61	0	1	1	0	0	0	0	1
-80	5F	0	1	0	1	1	1	1	1
-90	4B	0	1	0	0	1	0	1	1
-100	37	0	0	1	1	0	1	1	1
Mute	00	0	0	0	0	0	0	0	0

■ Balance (Select Address: 01H)

Channel Setting (CHS)	D7
Attenuated Bch Gain	0
Attenuated Ach Gain	1

Gain(dB)	BAL				
	D6	D5	D4	D3	D2
0	0	0	0	0	0
-1	0	0	0	0	1
-2	0	0	0	1	0
-3	0	0	0	1	1
-4	0	0	1	0	0
-5	0	0	1	0	1
-6	0	0	1	1	0
-7	0	0	1	1	1
-8	0	1	0	0	0
-9	0	1	0	0	1
-10	0	1	0	1	0
-11	0	1	0	1	1
-12	0	1	1	0	0
-13	0	1	1	0	1
-14	0	1	1	1	0
-15	0	1	1	1	1
-16	1	0	0	0	0
-17	1	0	0	0	1
-18	1	0	0	1	0
-19	1	0	0	1	1
-20	1	0	1	0	0
-21	1	0	1	0	1
-22	1	0	1	1	0
-23	1	0	1	1	1
-24	1	1	0	0	0
-25	1	1	0	0	1
-26	1	1	0	1	0
-27	1	1	0	1	1
-28	1	1	1	0	0
-29	1	1	1	0	1
-30	1	1	1	1	0
MUTE	1	1	1	1	1

■ Tone Control Bass (Select Address: 02H)

Bass	BCB
Cut or Boost	D7
Cut	0
Boost	1

		BASS			
Cut Gain(dB)	Boost Gain(dB)	D6	D5	D4	D3
-15	15	1	1	1	1
-14	14	1	1	1	0
-13	13	1	1	0	1
-12	12	1	1	0	0
-11	11	1	0	1	1
-10	10	1	0	1	0
-9	9	1	0	0	1
-8	8	1	0	0	0
-7	7	0	1	1	1
-6	6	0	1	1	0
-5	5	0	1	0	1
-4	4	0	1	0	0
-3	3	0	0	1	1
-2	2	0	0	1	0
-1	1	0	0	0	1
0	0	0	0	0	0

■ Tone Control Treble (Select Address: 03H)

Treble	BCT
Cut or Boost	D7
Cut	0
Boost	1

		TREB			
Cut Gain(dB)	Boost Gain(dB)	D6	D5	D4	D3
-15	15	1	1	1	1
-14	14	1	1	1	0
-13	13	1	1	0	1
-12	12	1	1	0	0
-11	11	1	0	1	1
-10	10	1	0	1	0
-9	9	1	0	0	1
-8	8	1	0	0	0
-7	7	0	1	1	1
-6	6	0	1	1	0
-5	5	0	1	0	1
-4	4	0	1	0	0
-3	3	0	0	1	1
-2	2	0	0	1	0
-1	1	0	0	0	1
0	0	0	0	0	0

■NOTE

1) The WOW technology right incorporated in the **NJW1180** are owned by SRS Labs, a U.S. Corporation and licensed to New Japan Radio Co., Ltd. Purchaser of **NJW1180** must sign a license for use of the chip and display of the SRS Labs trademarks. Any products incorporating the **NJW1180** must be sent to SRS Labs for review. WOW is protected under U.S. and foreign patents issued and/or pending. WOW, SRS and the  symbol are trademarks of SRS Labs, Inc. in the United States and selected foreign countries. Neither the purchase of the **NJW1180**, nor the corresponding sale of audio enhancement equipment conveys the right to sell commercialized recordings made with any SRS technology.

SRS Labs requires all set makers to comply with all rules and regulations as outlined in the SRS Trademark Usage Manual separately provided.

For further information, please contact:

SRS Labs, Inc.

2909 Daimler Street, Santa Ana, CA 92705 USA

Tel: 949-442-1070 Fax: 949-852-1099 <http://www.srslabs.com>

[CAUTION]

The specifications on this databook are only given for information, without any guarantee as regards either mistakes or omissions. The application circuits in this databook are described only to show representative usages of the product and not intended for the guarantee or permission of any right including the industrial rights.