



AUDIO PROCESSOR with BBE & Dynamic Bass Boost

■ GENERAL DESCRIPTION

The **NJW1182** is a TV audio processor with BBE Sound Enhancement and Dynamic Bass Boost.

The **NJW1182** contains all necessary functions to process TV audio signal such as volume control, tone control, balance, mute and AGC function.

All of internal status and variables are controlled by I²C BUS.

■ PACKAGE OUTLINE



NJW1182FP1

■ FEATURES

- Operating Voltage 7.5 to 13V
- I²C BUS Interface
- eala(NJRC Surround)/Simulated Stereo
- Dynamic Bass Boost Function
- Voice Enhancement Function
- AGC Circuit (Selectable 4-stage compression level by I2C BUS)
- Bi-CMOS Technology
- Package Outline QFP48-P1

■ BLOCK DIAGRAM

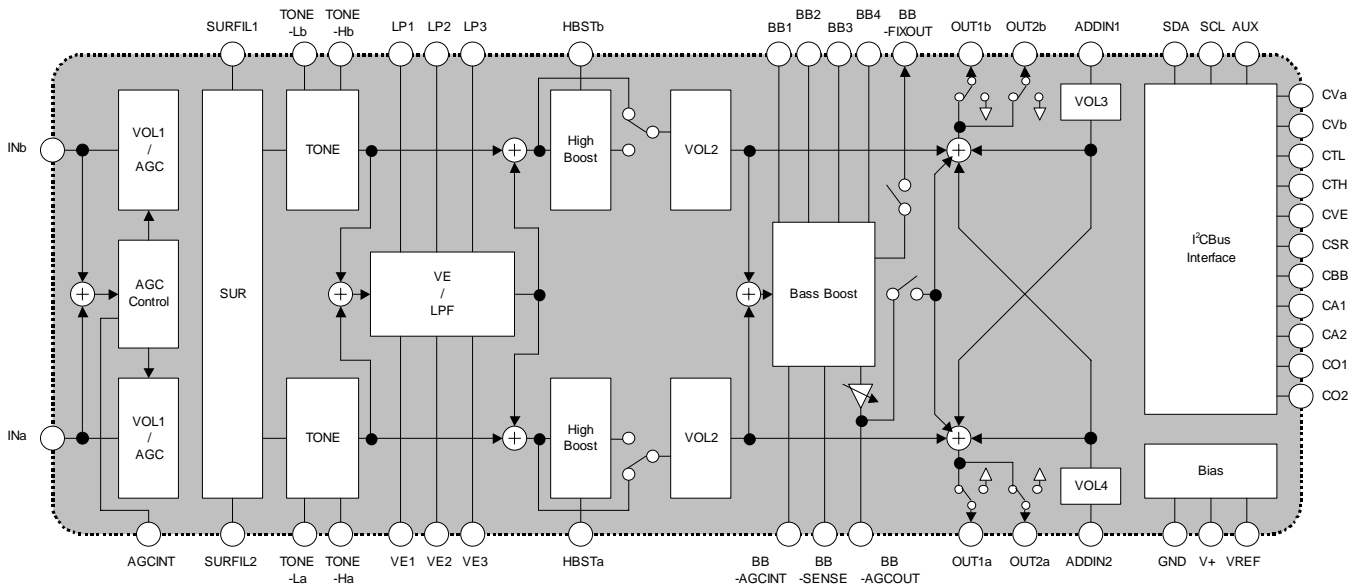

■ PIN FUNCTION (QFP48-P1)

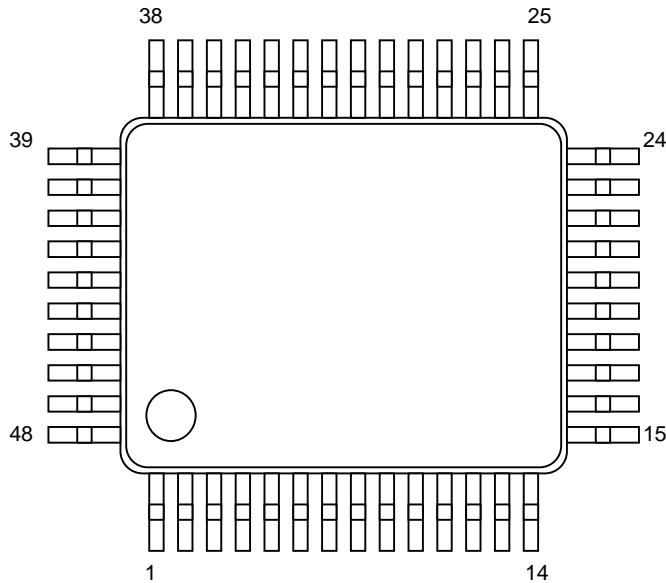

No	Symbol	Function	No	Symbol	Function
1	LP2	Voice Enhancement LF Filter 2	25	CVE	Pop Noise Reduction for VE ON/OFF
2	LP3	Voice Enhancement LF Filter 3	26	CA2	Pop Noise Reduction for ADDIN2 Setting
3	HBSTa	Ach High Frequency Compensation Filter	27	CTH	Pop Noise reduction for Treble Control
4	BB3	Filter for Bass Boost 3	28	CTL	Pop Noise reduction for Bass Control
5	BB4	Filter for Bass Boost 4	29	ADDIN2	Mixing Input 2
6	BB FIXOUT	Fixed Gain Bass Boost Output	30	OUT2b	Bch Output 2
7	BB AGCINT	AGC Smoothing Filter for Bass Boost	31	OUT1b	Bch Output 1
8	OUT1a	Ach Output 1	32	BB SENSE	AGC Boost Level Setting for Bass Boost
9	OUT2a	Ach Output 2	33	BB AGCOUT	Dynamic Bass Boost Output
10	ADDIN1	Mixing Input 1	34	BB2	Filter for Bass Boost 2
11	CSR	Pop Noise Reduction for Surround ON/OFF	35	BB1	Filter for Bass Boost 1
12	CBB	Pop Noise Reduction for Bass Boost ON/OFF	36	HBSTb	Bch High Frequency Compensation Filter
13	AGC INT	AGC Filter	37	VE3	Voice Enhancement HF Filter 3
14	CVa	Pop Noise Reduction for Volume Control	38	VE2	Voice Enhancement HF Filter 2
15	CVb	Pop Noise Reduction for Balance Control	39	VE1	Voice Enhancement HF Filter 1
16	CA1	Pop Noise Reduction for ADDIN1 Setting	40	TONE-Lb	Bch Bass Filter
17	SDA	SDA Data Input (I ² C BUS)	41	TONE-Hb	Bch Treble Filter
18	SCL	SCL Data Input (I ² C BUS)	42	SURFIL2	Surround Filter 2
19	GND	Ground	43	INb	Bch Input
20	V+	Power Supply	44	INa	Ach Input
21	AUX	Auxiliary Output	45	SURFIL1	Surround Filter 1
22	VREF	Reference Voltage	46	TONE-Ha	Ach Treble Filter
23	CO1	Pop Noise Reduction for Output SW1 ON/OFF	47	TONE-La	Ach Bass Filter
24	CO2	Pop Noise Reduction for Output SW2 ON/OFF	48	LP1	Voice Enhancement LF Filter 1

■ ABSOLUTE MAXIMUM RATING (Ta=25°C)

PARAMETER	SYMBOL	RATING	UNIT
Supply Voltage	V ⁺	15	V
Power Dissipation	P _D	1500(note)	mW
Operating Temperature Range	Topr	-20 to +75	°C
Storage Temperature Range	Tstg	-40 to +125	°C

(Note) At on a board of EIA/JEDEC specification. (76.2 x 114.3 x 1.6mm Two layers, FR-4)

■ ELECTRICAL CHARACTERISTICS (Ta=25°C, V+=9V, Rg=600Ω, RL=47kΩ, Vin=100mVrms/1kHz, MODE; VOL/BAL/TONE=0dB, AGC/VE/Surround/Bass Boost=OFF, ADDIN1/ADDIN2=MUTE unless otherwise specified)

PARAMETER	SYMBOL	TEST CONDITION	MIN.	TYP.	MAX.	UNIT
Operating Voltage	V ⁺	-	7.5	9.0	13.0	V
Supply Current	I _{CC}	No Signal	-	15	25	mA
Reference Voltage	V _{REF}	No Signal	4.0	4.5	5.0	V
Maximum Input Voltage	V _{IM}	VOL=-20dB, THD=10%	2.8	3.0	-	Vrms
Maximum Output Voltage	V _{OM}	OUTPUT VOL=0dB, THD=1%	-	2.5	-	Vrms
Channel Balance	G _{CB}	VOL=0dB	-1.0	0.0	1.0	dB
Balance Boost A	BA _{BST}	CHS="0", BAL="11111"	-2.0	0.0	2.0	dB
Balance Cut A	BA _{CUT}	CHS="1", BAL="11111" Vin=1Vrms	-	-	-70	dB
Balance Boost B	BB _{BST}	CHS="1", BAL="11111"	-2.0	0.0	2.0	dB
Balance Cut B	BB _{CUT}	CHS="0", BAL="11111" Vin=1Vrms	-	-	-70	dB
Total Harmonic Distortion	THD	Vo=0.5Vrms BW=400Hz ~ 30kHz	-	-	0.3	%
Maximum Gain	G _{VMAX}	VOL=0dB	-2.0	0.0	2.0	dB
Minimum Gain	G _{VMIN}	VOL=MUTE, Vin=2Vrms	-	-100	-90	dB
Channel Separation	CS	Vin=1Vrms, A-weighted	-	-	-70	dB
Output Noise 1	V _{NO1}	VOL = 0dB A-weighted	-	-90 (31.6)	-85 (56.2)	dBV (μVrms)
Output Noise 2	V _{NO2}	VOL=MUTE A-weighted	-	-100 (10)	-95 (17.8)	dBV (μVrms)
AUX Output Voltage	V _{AUX}	Logic Output: High, RL=10kΩ Pull Down	4.5	-	5.5	V
		Logic Output: Low, RL=10kΩ pull Up	0		0.5	

BW: Band Width

◆ TONE CONTROL

PARAMETER	SYMBOL	TEST CONDITION	MIN.	TYP.	MAX.	UNIT
High Frequency Boost	HF _{BST}	BCT="1", TREB="1111", f=10kHz	12.5	15.0	17.5	dB
High Frequency Flat	HF _{FLT}	TREB="0000", f=10kHz	-2.0	0.0	2.0	dB
High Frequency Cut	HF _{CUT}	BCT="0", TREB="1111", f=10kHz	-17.5	-15.0	-12.5	dB
Low Frequency Boost	LF _{BST}	BCB="1", BASS="1111", f=100Hz	12.5	15.0	17.5	dB
Low Frequency Flat	LF _{FLT}	BASS="0000", f=100Hz	-2.0	0.0	2.0	dB
Low Frequency Cut	LF _{CUT}	BCB="0", BASS="1111", f=100Hz	-17.5	-15.0	-12.5	dB

◆ AGC CONTROL (AGC=ON)

PARAMETER	SYMBOL	TEST CONDITION	MIN.	TYP.	MAX.	UNIT
AGC Boost	AGC _{BST}	Vin=50mVrms, f=1kHz	1.5	3.5	5.5	dB
AGC Flat1	AGC _{FLT1}	Vin=125mVrms, f=1kHz	-2.5	0.0	2.5	dB
AGC Flat2	AGC _{FLT2}	Vin=250mVrms, f=1kHz	-2.5	0.0	2.5	dB
AGC Flat3	AGC _{FLT3}	Vin=375mVrms, f=1kHz	-2.5	0.0	2.5	dB
AGC Flat4	AGC _{FLT4}	Vin=500mVrms, f=1kHz	-2.5	0.0	2.5	dB
AGC Cut	AGC _{CUT}	Vin=2Vrms, f=1kHz	-14	-10	-6.0	dB

◆ Voice Enhancement (VE=ON)

PARAMETER	SYMBOL	TEST CONDITION	MIN.	TYP.	MAX.	UNIT
Voice Enhancement Low Frequency Boost Range	VE _{GVL}	Voice-Low="1111", f=50Hz	-	10.0	-	dB
Voice Enhancement High Frequency Boost Range	VE _{GVH}	Voice-High="1111", f=6kHz	-	10.0	-	dB

◆ Surround (Surround=ON)

PARAMETER	SYMBOL	TEST CONDITION	MIN.	TYP.	MAX.	UNIT
Simulated Surround Gain A	SR _{SIMA}	Ain+Bin→Aout, f=1kHz	1.0	3.0	5.0	dB
Simulated Surround Gain B	SR _{SIMB}	Ain+Bin→Bout, f=1kHz	1.0	3.0	5.0	dB
eala Gain High1	SR _{GH1}	Ain→Aout, Mode=High, f=100Hz	6.0	8.0	10.0	dB
eala Gain High2	SR _{GH2}	Ain→Bout, Mode=High, f=100Hz	1.5	3.5	5.5	dB
eala Gain Low	SR _{GL}	Ain→Aout, Mode=Low, f=100Hz	2.0	4.0	6.0	dB
eala2 Gain High1	SR _{2GH1}	Ain→Aout, Mode=High, f=100Hz	8.0	10.0	12.0	dB
eala2 Gain High2	SR _{2GH2}	Ain→Bout, Mode=High, f=100Hz	4.5	6.5	8.5	dB
eala2 Gain Low	SR _{2GL}	Ain→Aout, Mode=Low, f=100Hz	2.0	4.0	6.0	dB

◆ Bass Boost (Bass Boost=ON)

PARAMETER	SYMBOL	TEST CONDITION	MIN.	TYP.	MAX.	UNIT
Bass Boost Gain High	BB _{GV1}	Ain+Bin→BB FIXOUT, f=100Hz, SWOUT=ON, Mode=High	-	12.0	-	dB
Bass Boost Gain Mid	BB _{GV2}	Ain+Bin→BB FIXOUT, f=100Hz, SWOUT=ON, Mode=Mid	-	6.0	-	dB
Bass Boost Gain Low	BB _{GV3}	Ain+Bin→BB FIXOUT, f=100Hz, SWOUT=ON, Mode=Low	-	2.0	-	dB
Bass Boost Gain High2	BB _{GV4}	Ain+Bin→Aout, f=100Hz, SWOUT=ON, Mode=High	-	1.0	-	dB

◆ADDIN1

PARAMETER	SYMBOL	TEST CONDITION	MIN.	TYP.	MAX.	UNIT
ADDIN1 Gain	ADD1 _{GV}	ADDIN1="111"	-	0.0	-	dB
ADDIN1 Mute	ADD1 _{MUTE}	ADDIN1="000"	-	-80	-	dB
High Boost	ADD1 _{HBST}	ADDIN1="111", f=10kHz	-	2.2	-	dB

◆ADDIN2

PARAMETER	SYMBOL	TEST CONDITION	MIN.	TYP.	MAX.	UNIT
ADDIN2 Gain	ADD2 _{GV}	ADDIN2="11111"	-	0.0	-	dB
ADDIN2 Mute	ADD2 _{MUTE}	ADDIN2="00000"	-	-80	-	dB

■ I²C BUS BLOCK CHARACTERISTICS (SDA, SCL)

I²C BUS Load Conditions: Pull up resistance 4k (Connected to +5V), Load capacitance 200pF (Connected to GND)

PARAMETER	SYM BOL	STANDARD MODE			FAST MODE			UNIT
		MIN.	TYP.	MAX.	MIN.	TYP.	MAX.	
Low Level Input Voltage	V _{IL}	0.0	-	1.5	0.0	-	1.5	V
High Level Input Voltage	V _{IH}	2.7	-	5.0	2.7	-	5.0	V
Hysteresis of Schmitt trigger inputs	V _{hys}	-	-	-	0.25	-	-	V
LOW level output voltage (3mA at SDA pin)	V _{OL}	0	-	0.4	0	-	0.4	V
Output fall time from V _{IHmin} to V _{ILmax} with a bus capacitance from 10pF to 400pF	t _{of}	-	-	250	²⁰ +0.1C _b	-	250	ns
Pulse width of spikes which must be suppressed by the input filter	t _{SP}	-	-	-	0	-	50	ns
Input current each I/O pin with an input voltage between 0.1V _{DD} and 0.9V _{DDmax}	I _i	-10	-	10	-10	-	10	μA
Capacitance for each I/O pin	C _i	-	-	10	-	-	10	pF
SCL clock frequency	f _{SCL}	-	-	100	-	-	400	kHz
Hold time (repeated) START condition.	t _{HD:STA}	4.0	-	-	0.6	-	-	μs
LOW period of the SCL clock	t _{LOW}	4.7	-	-	1.3	-	-	μs
HIGH period of the SCL clock	t _{HIGH}	4.0	-	-	0.6	-	-	μs
Set-up time for a repeated START condition	t _{SU:STA}	4.7	-	-	0.6	-	-	μs
Data hold time	t _{HD:DAT}	0	-	3.45	0	-	0.9	μs
Data set-up time	t _{SU:DAT}	250	-	-	100	-	-	ns
Rise time of both SDA and SCL signals	t _r	-	-	1000	-	-	300	ns
Fall time of both SDA and SCL signals	t _f	-	-	300	-	-	300	ns
Set-up time for STOP condition	t _{SU:STO}	4.0	-	-	0.6	-	-	μs
Bus free time between a STOP and START condition	t _{BUF}	4.7	-	-	1.3	-	-	μs
Capacitive load for each bus line	C _b	-	-	400	-	-	400	pF
Noise margin at the LOW level	V _{nL}	0.5	-	-	0.5	-	-	V
Noise margin at the HIGH level	V _{nH}	1	-	-	1	-	-	V

C_b ; total capacitance of one bus line in pF.

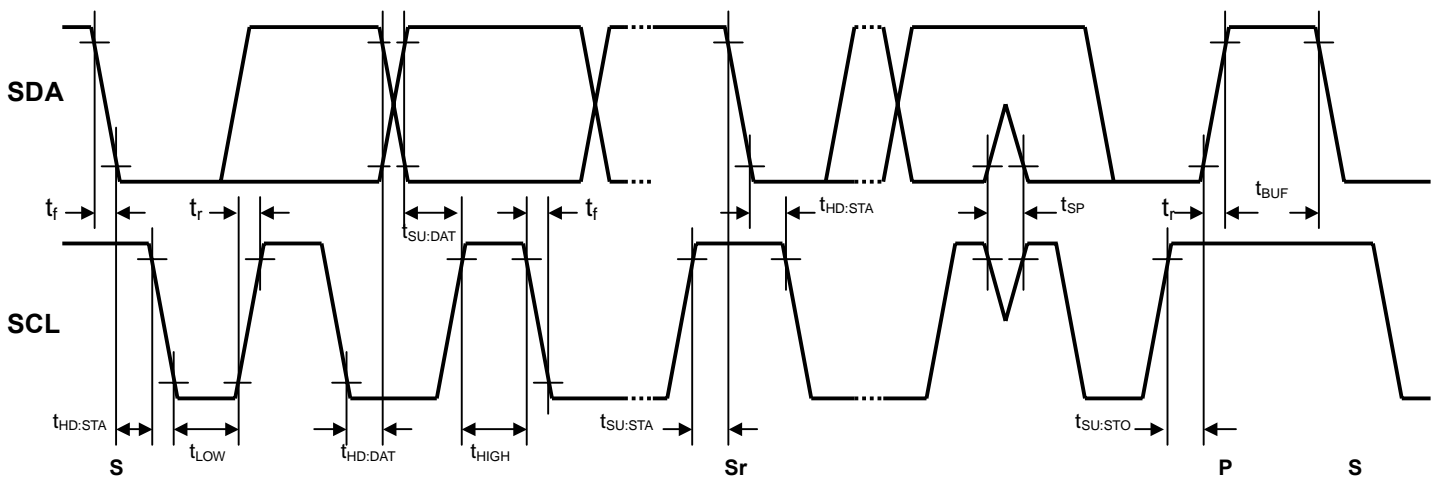

■ TERMINAL DESCRIPTION

No.	SYMBOL	FUNCTION	EQUIVALENT CIRCUIT	VOLTAGE
1	LP2	Voice Enhancement LF Filter 1		V+/2
2 48	LP3 LP1	Voice Enhancement LF Filter 3 Voice Enhancement LF Filter 2		V+/2
3 36	HBSTa HBSTb	Ach High Frequency Compensation Filter Bch High Frequency Compensation Filter		V+/2
5 35	BB3 BB1	Filter for Bass Boost 3 Filter for Bass Boost 1		V+/2

■ TERMINAL DESCRIPTION

No.	SYMBOL	FUNCTION	EQUIVALENT CIRCUIT	VOLTAGE
5 34	BB4 BB2	Filter for Bass Boost 4 Filter for Bass Boost 2		V+/2
6 33	BBFIXOUT BBAGCOUT	Fixed Gain Bass Boost Output Dynamic Bass Boost Output		V+/2
7	BBAGCINT	AGC Smoothing Filter for Bass Boost		0.7V
8 9 30 31	OUT1a OUT2a OUT2b OUT1b	Ach Output 1 Ach Output 2 Bch Output 2 Bch Output 1		V+/2

■ **TERMINAL DESCRIPTION**

No.	SYMBOL	FUNCTION	EQUIVALENT CIRCUIT	VOLTAGE
10 29	ADDIN1 ADDIN2	Mixing Input 1 Mixing Input2		V+/2
11	CSR	Pop Noise Reduction for Surround ON/OFF		0.9V (SUR=OFF)
12	CBB	Pop Noise Reduction for Bass Boost ON/OFF		0V (BassBoost=OFF)
13	AGCINT	AGC Filter		1.4V (no signal)

■TERMINAL DESCRIPTION

No.	SYMBOL	FUNCTION	EQUIVALENT CIRCUIT	VOLTAGE
14	CVa	Pop Noise Reduction for Volume Control		VREF-0.7V (VOL=0dB)
15	CVb	Pop Noise Reduction for Balance Control		VREF-0.7V (BAL=Center)
16	CA1	Pop Noise Reduction for ADDIN1 Setting		VREF-0.7V (ADDIN1=0dB)
17	SDA	SDA Data Input (I ² C BUS)		-
18	SCL	SDA Clock Input (I ² C BUS)		

■ **TERMINAL DESCRIPTION**

No.	SYMBOL	FUNCTION	EQUIVALENT CIRCUIT	VOLTAGE
19	GND	Ground	-	-
20	V+	Power Supply	-	-
21	AUX	Auxiliary Output		0V (AUX=Low)
22	VREF	Reference Voltage		V+/2
23	CO1	Pop Noise Reduction for Output SW1 ON/OFF		0V (OUT1/2=Mute)
24	CO2	Pop Noise Reduction for Output SW2 ON/OFF		

■ TERMINAL DESCRIPTION

No.	SYMBOL	FUNCTION	EQUIVALENT CIRCUIT	VOLTAGE
25	CVE	Pop Noise Reduction for VE ON/OFF		VREF-0.7V (VE=OFF)
26	CA2	Pop Noise Reduction for ADDIN2 Setting		VREF-0.7V (ADDIN2=0dB)
27	CTH	Pop Noise reduction for Treble Control		VREF-0.7V (TONE=Flat)
28	CTL	Pop Noise reduction for Bass Control		
32	BBSENSE	AGC Boost Level Setting for Bass Boost		V+/2

■ **TERMINAL DESCRIPTION**

No.	SYMBOL	FUNCTION	EQUIVALENT CIRCUIT	VOLTAGE
37 38	VE3 VE2	Voice Enhancement HF Filter 3 Voice Enhancement HF Filter 2		V+/2
39	VE1	Voice Enhancement HF Filter 1		V+/2
40 47	TONE-Lb TONE-La	Bch Bass Filter Bch Bass Filter		V+/2
41 46	TONE-Hb TONE-Ha	Bch Treble Filter Ach Treble Filter		V+/2

■ TERMINAL DESCRIPTION

No.	SYMBOL	FUNCTION	EQUIVALENT CIRCUIT	VOLTAGE
42	SURFIL2	Surround Filter 2		V+/2
43 44	INb INa	Bch Input Ach Input		V+/2
45	SURFIL1	Surround Filter 1		V+/2

TEST CIRCUIT

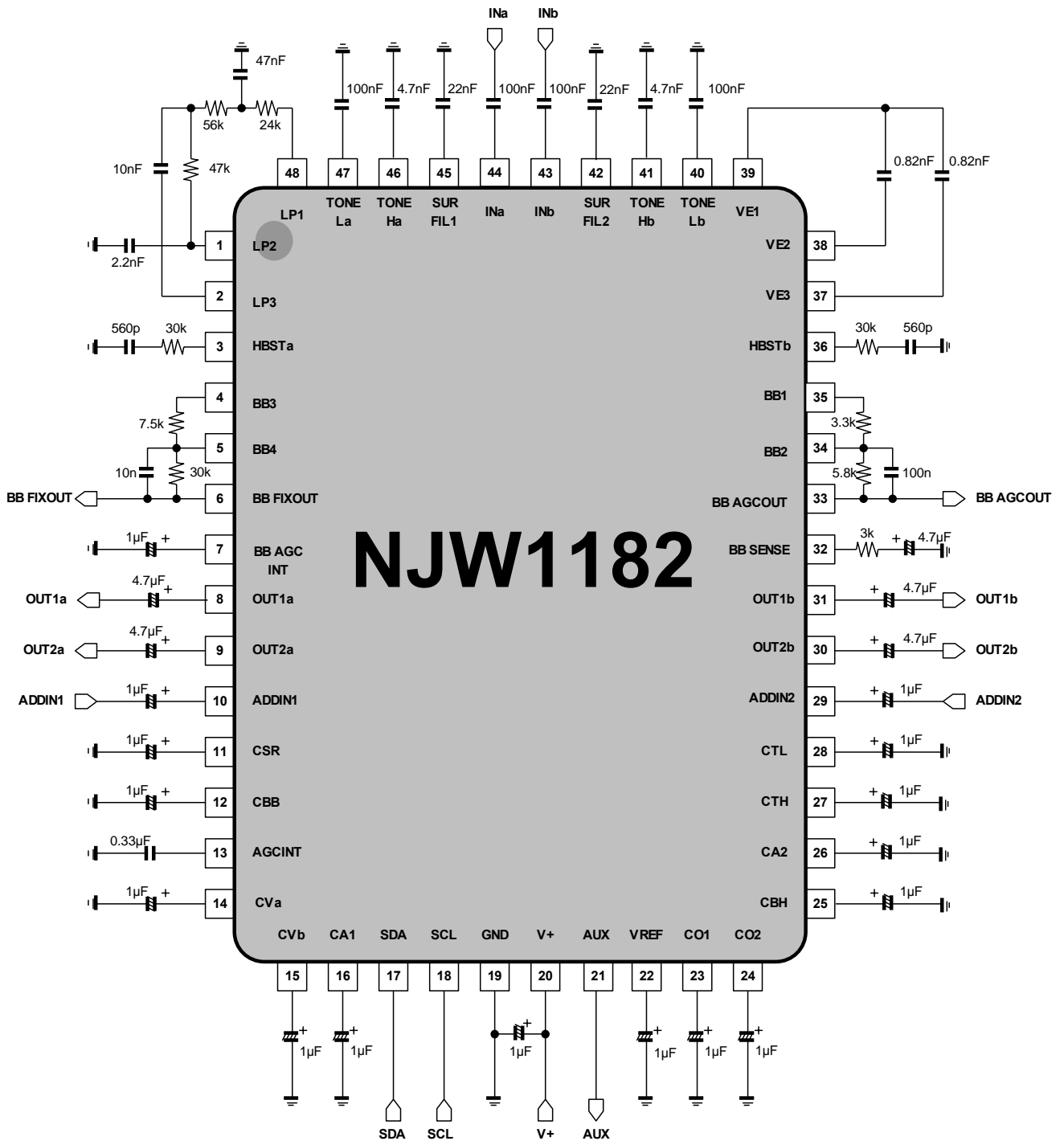

APPLICATION CIRCUIT

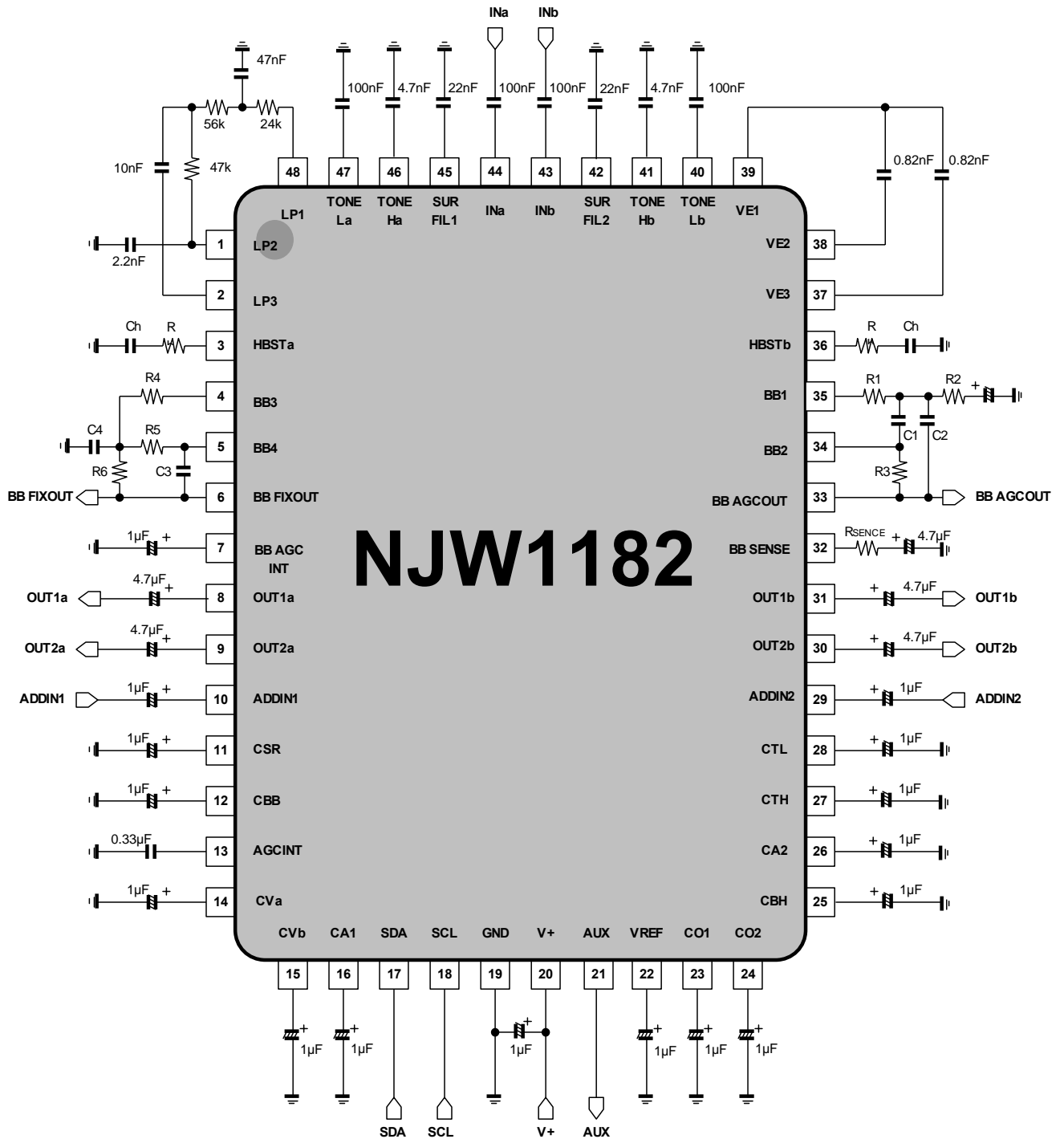

(*) Separate the I²C bus line and Signal line from the following terminals for avoiding digital noise problem and cross talk.

Pin No.	Symbol	Pin No.	Symbol	Pin No.	Symbol	Pin No.	Symbol
1	LP2	37	VE3	41	TONE-Hb	47	TONE-La
2	LP3	38	VE2	42	SURFIL2	48	LP1
3	HBSTa	39	VE1	45	SURFIL1	-	-
36	HBSTb	40	TONE-Lb	46	TONE-Ha	-	-

■ DEFINITION OF I²C REGISTER

◆ I²C BUS FORMAT

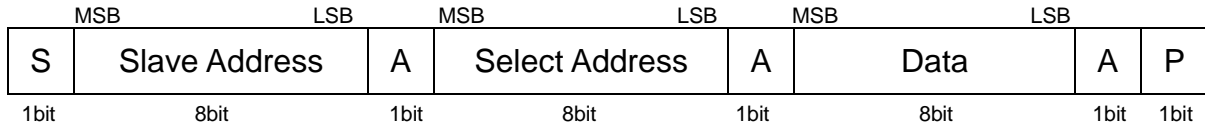

S: Starting Term

A: Acknowledge Bit

P: Ending Term

◆ SLAVE ADDRESS

MSB	LSB
1	R/W
0	0
0	0
0	0
0	0
0	1

R/W=0: Receive Only

◆ CONTROL REGISTER TABLE

The select address sets each function (Volume, Balance, AGC, Surround, Tone Control, BBE, AUX etc.).

The auto increment function cycles the select address as follows.

00H → 01H → 02H → 03H → 04H → 05H → 06H → 00H

Select Address	BIT							
	D7	D6	D5	D4	D3	D2	D1	D0
00H	VOL							
01H	CHS	BAL				AGC	SUR	
02H	BCB	BASS			Don't Care			
03H	BCT	TREB			OUT2	OUT1	2.1ch	
04H	Voice-Low				Voice-High			
05H	Bass Boost	SUR1	SUR0	AGC1	AGC0	SWOUT	AUX	
06H	ADDIN2				ADDIN1			

◆ CONTROL REGISTER DEFAULT VALUE

Control register default value is all "0".

Select Address	BIT							
	D7	D6	D5	D4	D3	D2	D1	D0
00H	0	0	0	0	0	0	0	0
01H	0	0	0	0	0	0	0	0
02H	0	0	0	0	0	0	0	0
03H	0	0	0	0	0	0	0	0
04H	0	0	0	0	0	0	0	0
05H	0	0	0	0	0	0	0	0
06H	0	0	0	0	0	0	0	0

■ INSTRUCTION CODE

a) MASTER VOLUME SETTING

Select Address	BIT							
	D7	D6	D5	D4	D3	D2	D1	D0
00H	VOL							

The volume control for both Ach and Bch (0.33dB/step).

The volume is consisted of volume1 and volume2 and the level is divided into half to each volume1 and volume2.

b) BALANCE, AGC AND SURROUND SETTING

Select Address	BIT							
	D7	D6	D5	D4	D3	D2	D1	D0
01H	CHS	BAL					AGC	SUR

•CHS: Channel select for balance control

“0”: Ach “Bch is attenuated”

“1”: Bch “Ach is attenuated”

•BAL: Balance control for both Ach and Bch (1dB/Step)

The balance is consisted of volume1 and volume2 and the level is divided into half to each volume1 and volume2.

•AGC: AGC switch

“0”: AGC OFF

“1”: AGC ON (Default : 250mVrms)

•SUR: Surround Mode Settings (with 05H,D4)

c) TONE CONTROL BASS SETTING

Select Address	BIT								
	D7	D6	D5	D4	D3	D2	D1	D0	
02H	BCB	BASS					Don't Care		

•BCB: Boost cut select for Bass control

“0”: Cut

“1”: Boost

•BASS: BASS control

Cut Level : -15dB to 0dB(1dB/Step)

Boost Level : 0dB to +15dB(1dB/Step)

d) TONE CONTROL TREBLE AND OUTPUT SWITCH SETTING

Select Address	BIT								
	D7	D6	D5	D4	D3	D2	D1	D0	
03H	BCT	TREB					OUT2	OUT1	2.1ch

•BCT: Boost cut select for Treble control

“0”: Cut

“1”: Boost

•TREB: Treble control (1dB/step)

Cut Level : -15dB to 0dB(1dB/Step)

Boost Level : 0dB to +15dB(1dB/Step)

•OUT2/OUT1: No.8,31pin and No.9,31pin Out Switch Setting

“0” = OFF

“1” = ON

●2.1ch: 2.1ch Output Mode Select

“0” = Bass Boost effect is added to main pass (OUTa/OUTb).

“1” = Bass Boost effect isn't added to main pass (OUTa/OUTb).

(NOTE) Usually, Bass Boost effect is outputted from BB AGCOUT terminal.

e) Voice Enhancement Boost Level Setting

Select Address	BIT							
	D7	D6	D5	D4	D3	D2	D1	D0
04H	Voice-Low				Voice-High			

• Voice-Low : 0dB to 10dB

• Voice-High : 0dB to 10dB

When all bits are “0”(=00H), VE becomes off

f) BASS BOOST MODE, AGC, SURROUND MODE, SUB WOOFER OUT AND AUXILIARY SETTING

Select Address	BIT							
	D7	D6	D5	D4	D3	D2	D1	D0
05H	Bass Boost		SUR1	SUR0	AGC1	AGC0	SWOUT	AUX

•AGC Level Setting

AGC Flat Level	AGC1(D3)	AGC0(D2)
125mVrms	0	0
250mVrms	0	1
375mVrms	1	0
500mVrms	1	1

•Surround Setting

Surround Mode Setting	SUR1	SUR0	SUR	Remarks
Surround OFF	0	0	0	Input Through
eala effect 2	0	1	0	Surround Effect High
eala effect 1	0	1	1	Surround Effect Low
eala2 effect 2	1	0	0	Surround Effect High
eala2 effect 1	1	0	1	Surround Effect Low
Simulated Stereo	0	0	1	For monaural signal input only

• Bass Boost Setting

Bass Boost Level	D7	D6	Remarks
Bass Boost OFF	0	0	Input Through
Bass Boost LOW	0	1	Bass Boost Effect Low
Bass Boost MID	1	0	Bass Boost Effect Middle
Bass Boost HIGH	1	1	Bass Boost Effect High

•SWOUT: Out Switch Setting for BB FIXOUT terminal

“0” = OFF

“1” = ON

•AUX1/AUX0: Auxiliary port High/Low

“0”: Logic output “Low”

“1”: Logic output “High”

g) ADDIN1 AND ADDIN2 OUTPUT SETTING

Select Address	BIT							
	D7	D6	D5	D4	D3	D2	D1	D0
06H	ADDIN2				ADDIN1			

- ADDIN1 : ADDIN1 Level Setting
 "000"= The ADDIN1 terminal is not available (MUTE), High Frequency Boost ON
 0dB to -24dB (4dB/step), High Frequency Boost OFF
- ADDIN2 : ADDIN2 Level Setting
 "00000"= The ADDIN2 terminal is not available (MUTE)
 0dB to -58dB (2dB/step)

■MASTER VOLUME SETTING (Select Address: 00H)

		VOL							
Gain (dB)	HEX	D7	D6	D5	D4	D3	D2	D1	D0
0	FF	1	1	1	1	1	1	1	1
-1	FC	1	1	1	1	1	1	0	0
-2	F9	1	1	1	1	1	0	0	1
-3	F6	1	1	1	1	0	1	1	0
-4	F3	1	1	1	1	0	0	1	1
-5	F0	1	1	1	1	0	0	0	0
-6	ED	1	1	1	0	1	1	0	1
-7	EA	1	1	1	0	1	0	1	0
-8	E7	1	1	1	0	0	1	1	1
-9	E4	1	1	1	0	0	1	0	0
-10	E1	1	1	1	0	0	0	0	1
-11	DE	1	1	0	1	1	1	1	0
-12	DB	1	1	0	1	1	0	1	1
-13	D8	1	1	0	1	1	0	0	0
-14	D5	1	1	0	1	0	1	0	1
-15	D2	1	1	0	1	0	0	1	0
-16	CF	1	1	0	0	1	1	1	1
-17	CC	1	1	0	0	1	1	0	0
-18	C9	1	1	0	0	1	0	0	1
-19	C6	1	1	0	0	0	1	1	0
-20	C3	1	1	0	0	0	0	1	1
-21	C0	1	1	0	0	0	0	0	0
-22	BD	1	0	1	1	1	1	0	1
-23	BA	1	0	1	1	1	0	1	0
-24	B7	1	0	1	1	0	1	1	1
-25	B4	1	0	1	1	0	1	0	0
-26	B1	1	0	1	1	0	0	0	1
-27	AE	1	0	1	0	1	1	1	0
-28	AB	1	0	1	0	1	0	1	1
-29	A8	1	0	1	0	1	0	0	0
-30	A5	1	0	1	0	0	1	0	1
-31	A2	1	0	1	0	0	0	1	0
-32	9F	1	0	0	1	1	1	1	1
-33	9C	1	0	0	1	1	1	0	0
-34	99	1	0	0	1	1	0	0	1
-35	96	1	0	0	1	0	1	1	0
-36	93	1	0	0	1	0	0	1	1
-37	90	1	0	0	1	0	0	0	0
-38	8D	1	0	0	0	1	1	0	1
-39	8A	1	0	0	0	1	0	1	0
-40	87	1	0	0	0	0	1	1	1
-41	84	1	0	0	0	0	1	0	0
-42	81	1	0	0	0	0	0	0	1

■MASTER VOLUME SETTING (Cont'd)

		VOL							
Gain (dB)	HEX	D7	D6	D5	D4	D3	D2	D1	D0
-43	7E	0	1	1	1	1	1	1	0
-44	7B	0	1	1	1	1	0	1	1
-45	78	0	1	1	1	1	0	0	0
-46	75	0	1	1	1	0	1	0	1
-47	72	0	1	1	1	0	0	1	0
-48	6F	0	1	1	0	1	1	1	1
-49	6C	0	1	1	0	1	1	0	0
-50	69	0	1	1	0	1	0	0	1
-51	66	0	1	1	0	0	1	1	0
-52	63	0	1	1	0	0	0	1	1
-53	60	0	1	1	0	0	0	0	0
-54	5D	0	1	0	1	1	1	0	1
-55	5A	0	1	0	1	1	0	1	0
-56	57	0	1	0	1	0	1	1	1
-57	54	0	1	0	1	0	1	0	0
-58	51	0	1	0	1	0	0	0	1
-59	4E	0	1	0	0	1	1	1	0
-60	4B	0	1	0	0	1	0	1	1
-61	48	0	1	0	0	1	0	0	0
-62	45	0	1	0	0	0	1	0	1
-63	42	0	1	0	0	0	0	1	0
-64	3F	0	0	1	1	1	1	1	1
-65	3C	0	0	1	1	1	1	0	0
-66	39	0	0	1	1	1	0	0	1
-67	36	0	0	1	1	0	1	1	0
-68	33	0	0	1	1	0	0	1	1
-69	30	0	0	1	1	0	0	0	0
-70	2D	0	0	1	0	1	1	0	1
-71	2A	0	0	1	0	1	0	1	0
-72	27	0	0	1	0	0	1	1	1
-73	24	0	0	1	0	0	1	0	0
-74	21	0	0	1	0	0	0	0	1
-75	1E	0	0	0	1	1	1	1	0
-76	1B	0	0	0	1	1	0	1	1
-77	18	0	0	0	1	1	0	0	0
-78	15	0	0	0	1	0	1	0	1
-79	12	0	0	0	1	0	0	1	0
-80	0F	0	0	0	0	1	1	1	1
-81	0C	0	0	0	0	1	1	0	0
-82	09	0	0	0	0	1	0	0	1
-83	06	0	0	0	0	0	1	1	0
-84	03	0	0	0	0	0	0	1	1
Mute	00	0	0	0	0	0	0	0	0

■BALANCE SETTING (Select Address: 01H)

Channel Select (CHS)	D7
Ach (Bch is attenuated)	0
Bch (Ach is attenuated)	1

Gain (dB)	BAL				
	D6	D5	D4	D3	D2
0	0	0	0	0	0
-1	0	0	0	0	1
-2	0	0	0	1	0
-3	0	0	0	1	1
-4	0	0	1	0	0
-5	0	0	1	0	1
-6	0	0	1	1	0
-7	0	0	1	1	1
-8	0	1	0	0	0
-9	0	1	0	0	1
-10	0	1	0	1	0
-11	0	1	0	1	1
-12	0	1	1	0	0
-13	0	1	1	0	1
-14	0	1	1	1	0
-15	0	1	1	1	1
-16	1	0	0	0	0
-17	1	0	0	0	1
-18	1	0	0	1	0
-19	1	0	0	1	1
-20	1	0	1	0	0
-21	1	0	1	0	1
-22	1	0	1	1	0
-23	1	0	1	1	1
-24	1	1	0	0	0
-25	1	1	0	0	1
-26	1	1	0	1	0
-27	1	1	0	1	1
-28	1	1	1	0	0
-29	1	1	1	0	1
-30	1	1	1	1	0
Mute	1	1	1	1	1

■TONE CONTROL BASS SETTINGS (Select Address: 02H)

Bass Cut or Boost	BCB
	D7
Cut	0
Boost	1

Cut Gain (dB) / Boost Gain (dB)		BASS			
		D6	D5	D4	D3
-15	15	1	1	1	1
-14	14	1	1	1	0
-13	13	1	1	0	1
-12	12	1	1	0	0
-11	11	1	0	1	1
-10	10	1	0	1	0
-9	9	1	0	0	1
-8	8	1	0	0	0
-7	7	0	1	1	1
-6	6	0	1	1	0
-5	5	0	1	0	1
-4	4	0	1	0	0
-3	3	0	0	1	1
-2	2	0	0	1	0
-1	1	0	0	0	1
0	0	0	0	0	0

■TONE CONTROL TREBLE SETTINGS (Select Address: 03H)

Treble Cut or Boost	BCT
	D7
Cut	0
Boost	1

Cut Gain (dB) / Boost Gain (dB)		TREB			
		D6	D5	D4	D3
-15	15	1	1	1	1
-14	14	1	1	1	0
-13	13	1	1	0	1
-12	12	1	1	0	0
-11	11	1	0	1	1
-10	10	1	0	1	0
-9	9	1	0	0	1
-8	8	1	0	0	0
-7	7	0	1	1	1
-6	6	0	1	1	0
-5	5	0	1	0	1
-4	4	0	1	0	0
-3	3	0	0	1	1
-2	2	0	0	1	0
-1	1	0	0	0	1
0	0	0	0	0	0

■Voice-Low / Voice-High GAIN SETTING (Select Address: 04H)

Boost Gain (dB)	Voice-Low			
	D7	D6	D5	D4
10	1	1	1	1
9.3	1	1	1	0
8.7	1	1	0	1
8.1	1	1	0	0
7.5	1	0	1	1
6.9	1	0	1	0
6.4	1	0	0	1
5.9	1	0	0	0
5.4	0	1	1	1
4.9	0	1	1	0
4.5	0	1	0	1
4.1	0	1	0	0
3.8	0	0	1	1
3.4	0	0	1	0
3.1	0	0	0	1
0	0	0	0	0

Boost Gain (dB)	Voice-High			
	D3	D2	D1	D0
10	1	1	1	1
9.3	1	1	1	0
8.7	1	1	0	1
8.1	1	1	0	0
7.5	1	0	1	1
6.9	1	0	1	0
6.4	1	0	0	1
5.9	1	0	0	0
5.4	0	1	1	1
4.9	0	1	1	0
4.5	0	1	0	1
4.1	0	1	0	0
3.8	0	0	1	1
3.4	0	0	1	0
3.1	0	0	0	1
OFF	0	0	0	0

■ ADDIN1 GAIN SETTING (Select Address: 06H)

Gain (dB)	ADDIN1		
	D2	D1	D0
0	1	1	1
-4	1	1	0
-8	1	0	1
-12	1	0	0
-16	0	1	1
-20	0	1	0
-24	0	0	1
MUTE	0	0	0

■ ADDIN2 GAIN SETTING (Select Address: 06H)

Gain (dB)	ADDIN2				
	D7	D6	D5	D4	D3
0	1	1	1	1	1
-2	1	1	1	1	0
-4	1	1	1	0	1
-6	1	1	1	0	0
-8	1	1	0	1	1
-10	1	1	0	1	0
-12	1	1	0	0	1
-14	1	1	0	0	0
-16	1	0	1	1	1
-18	1	0	1	1	0
-20	1	0	1	0	1
-22	1	0	1	0	0
-24	1	0	0	1	1
-26	1	0	0	1	0
-28	1	0	0	0	1
-30	1	0	0	0	0
-32	0	1	1	1	1
-34	0	1	1	1	0
-36	0	1	1	0	1
-38	0	1	1	0	0
-40	0	1	0	1	1
-42	0	1	0	1	0
-44	0	1	0	0	1
-46	0	1	0	0	0
-48	0	0	1	1	1
-50	0	0	1	1	0
-52	0	0	1	0	1
-54	0	0	1	0	0
-56	0	0	0	1	1
-58	0	0	0	1	0
MUTE	0	0	0	0	-

■ TYPICAL CHARACTERISTICS

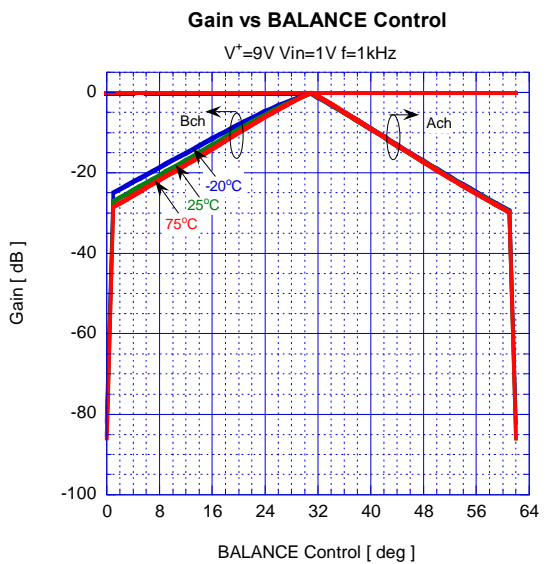
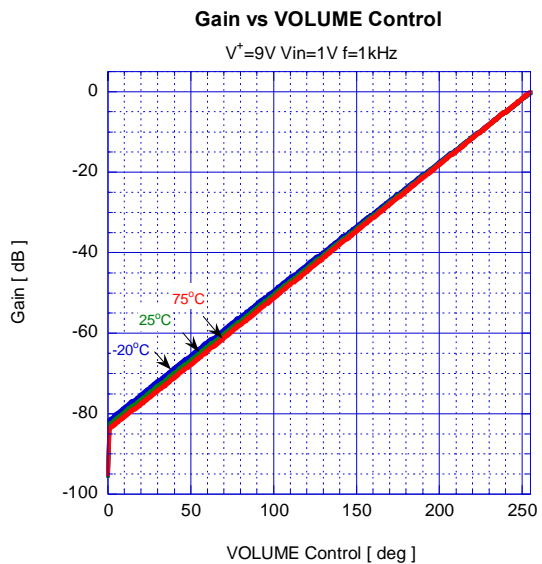
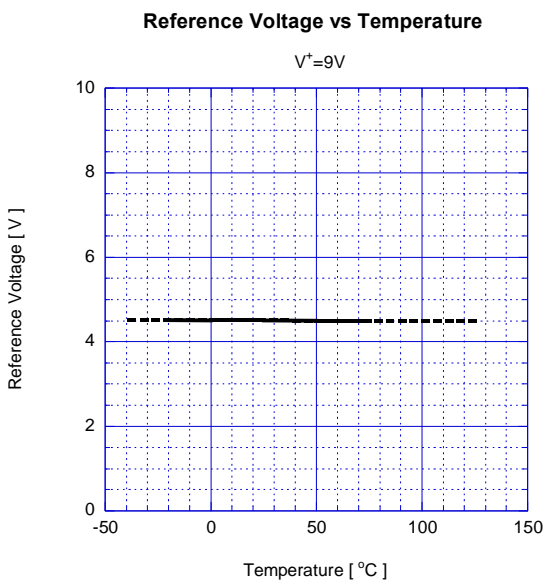
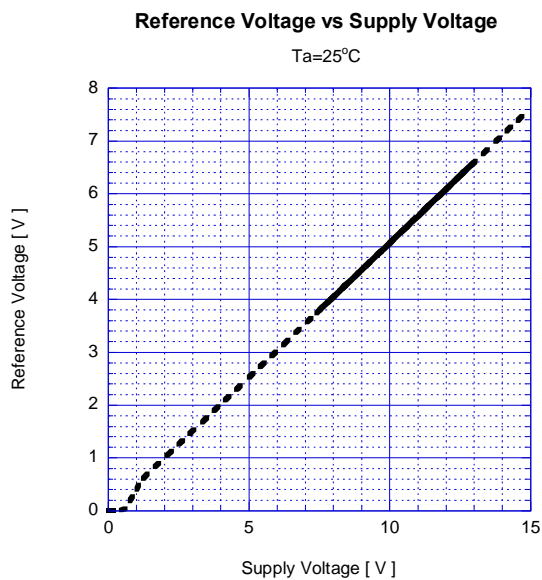
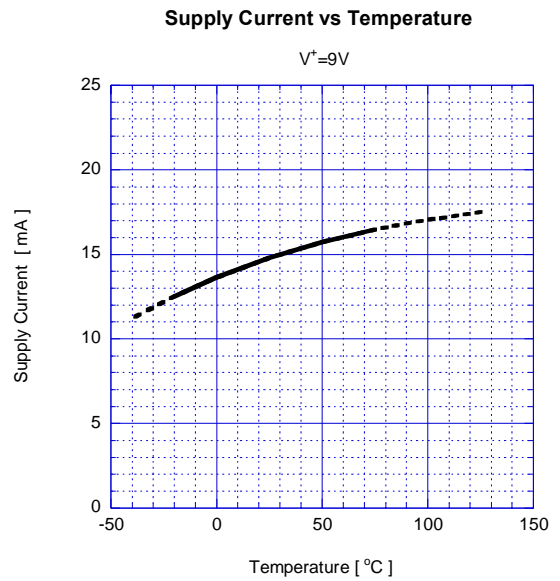
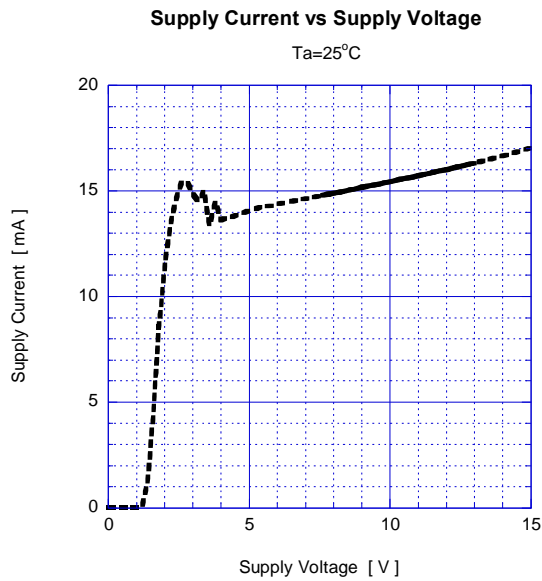

■ TYPICAL CHARACTERISTICS

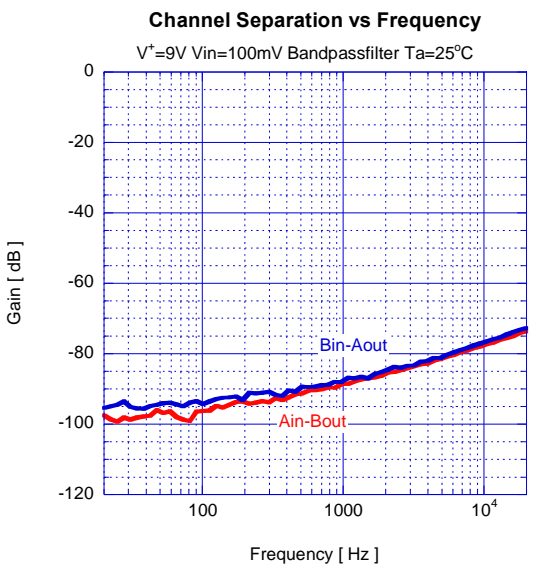
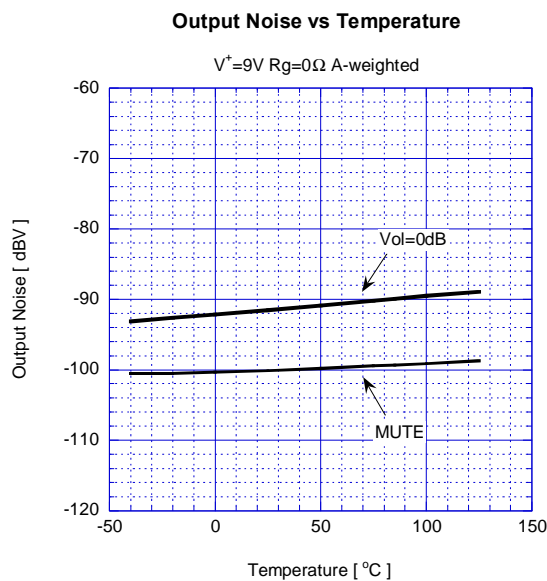
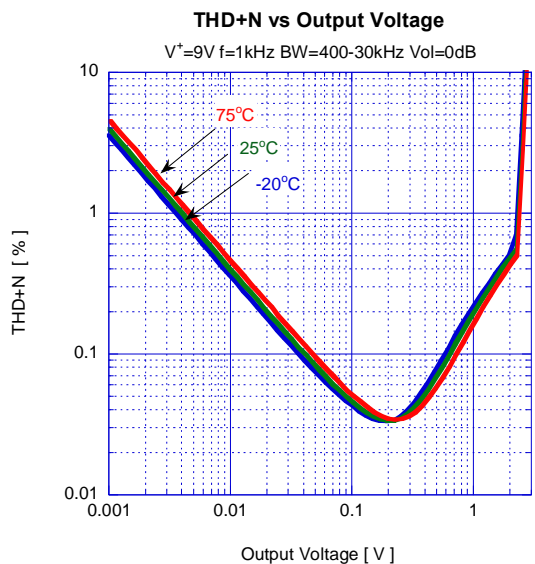
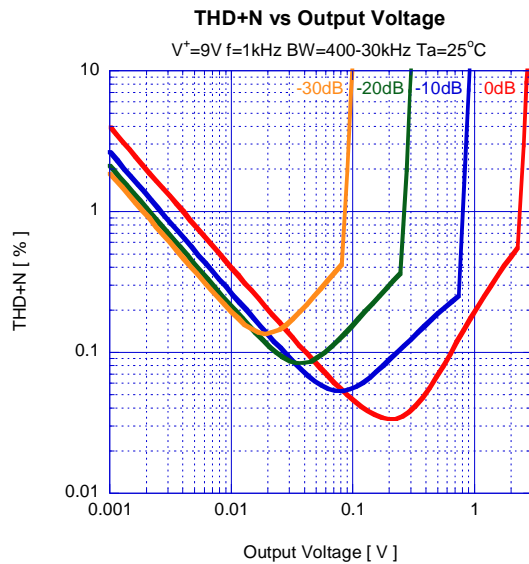
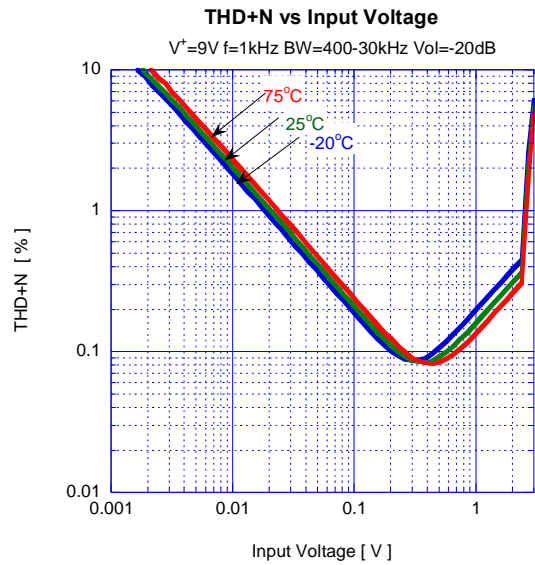
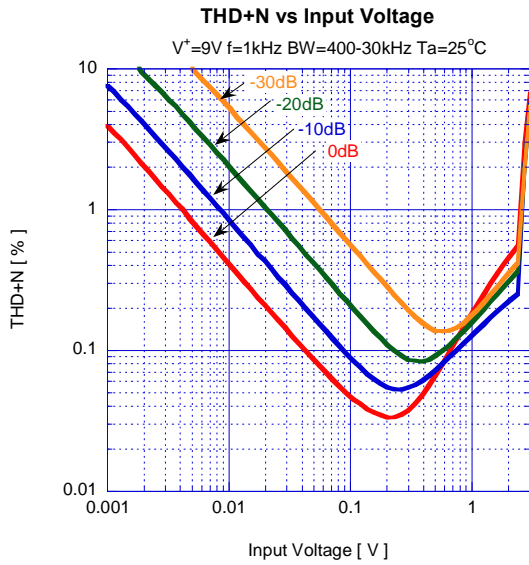

■ TYPICAL CHARACTERISTICS

AGC Characteristics

$V^+=9V$ $f=1kHz$ $T_a=25^\circ C$

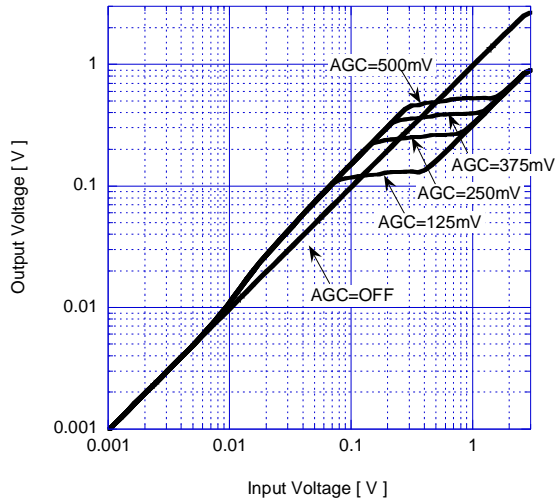

AGC Characteristics

$V^+=9V$ $f=1kHz$

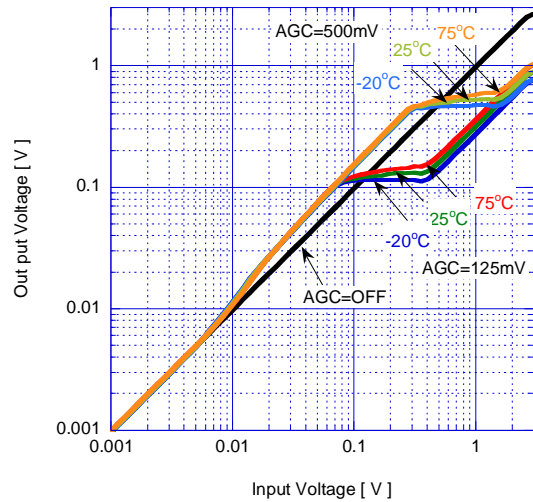

Gain vs Frequency (TONE)

$V^+=9V$ $V_{in}=100mV$ $T_a=25^\circ C$

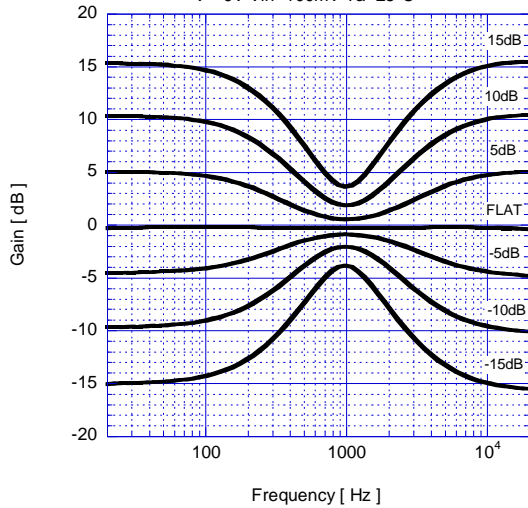

Gain vs Frequency (TONE)

$V^+=9V$ $V_{in}=100mV$ TONE=+15/-15dB

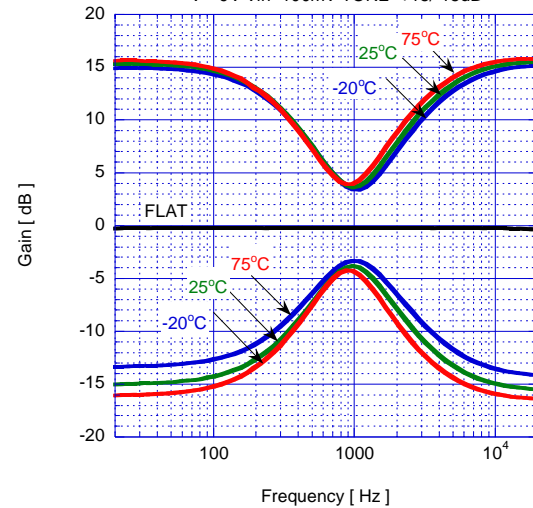

Gain vs Frequency (VE)

$V^+=9V$ $V_{in}=100mV$ $T_a=25^\circ C$

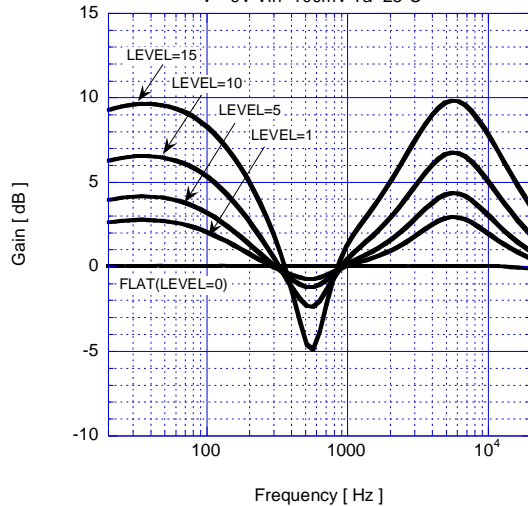

Gain vs Frequency (VE)

$V^+=9V$ $V_{in}=100mV$ VE Level=Max.

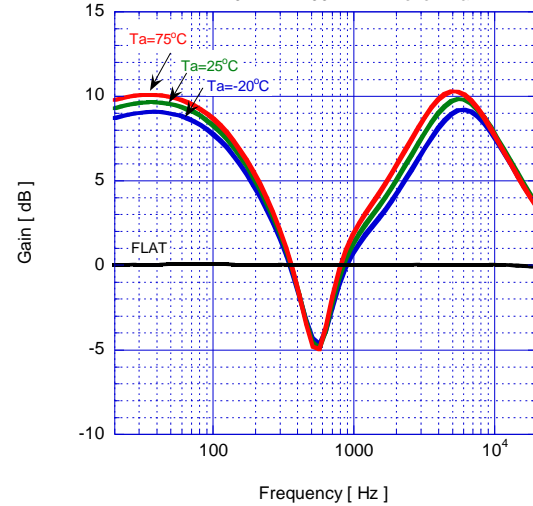

■ TYPICAL CHARACTERISTICS

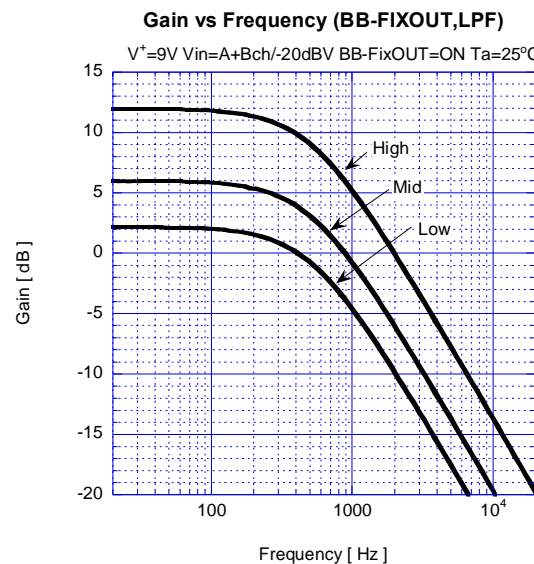
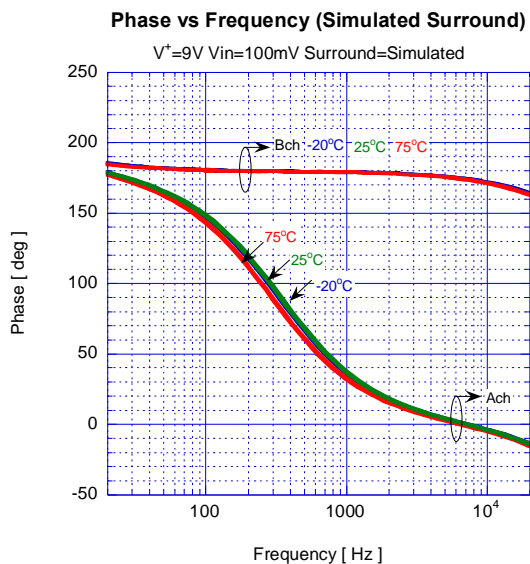
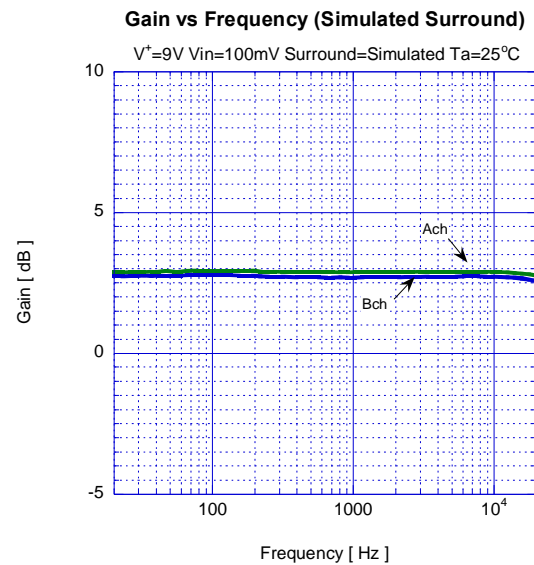
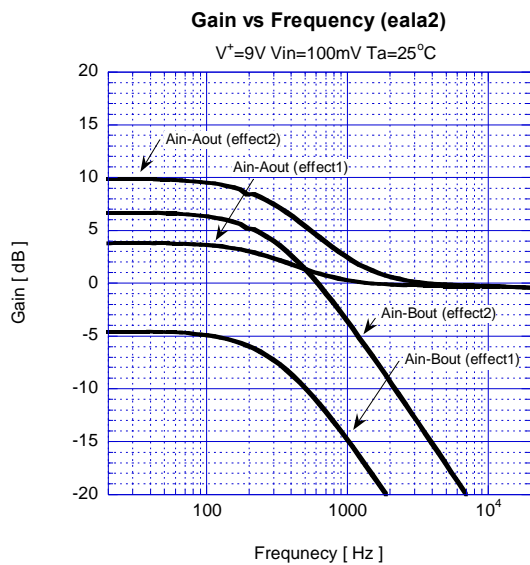
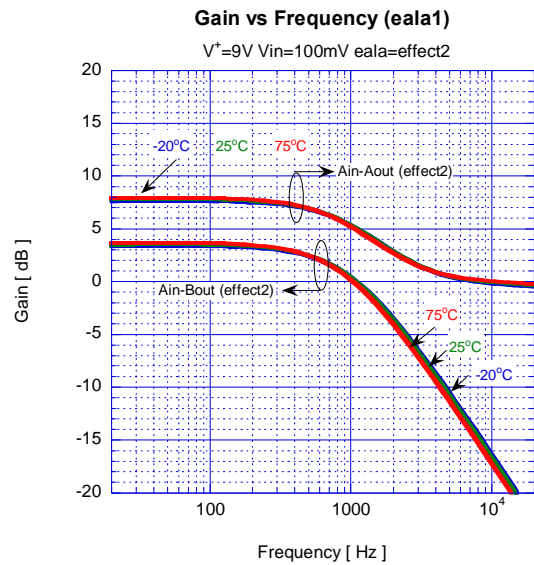
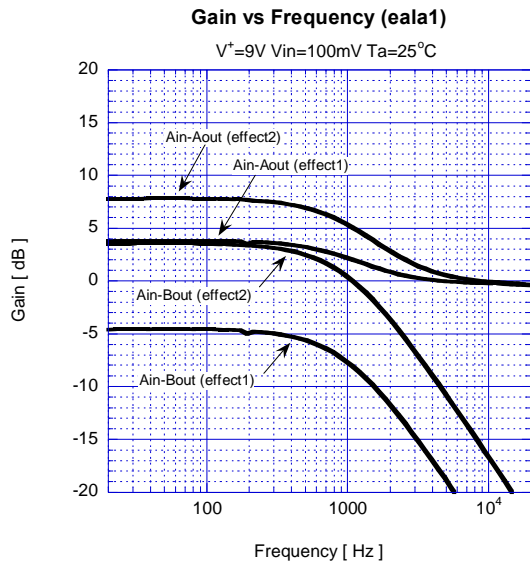

■ TYPICAL CHARACTERISTICS

Gain vs Frequency (BB-AGCOUT, LPF)

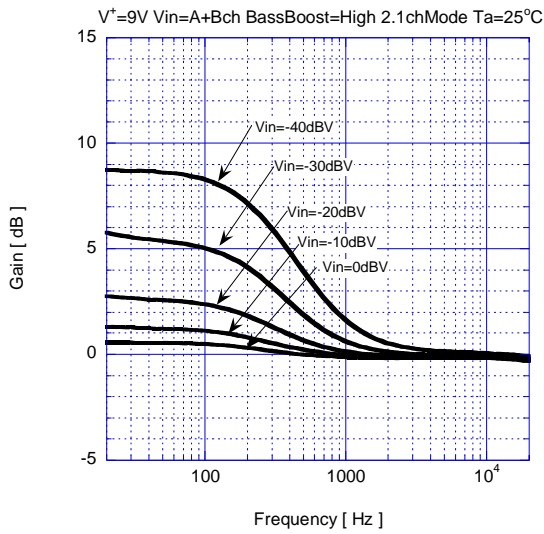

BassBoost AGC Characteristics (LPF)

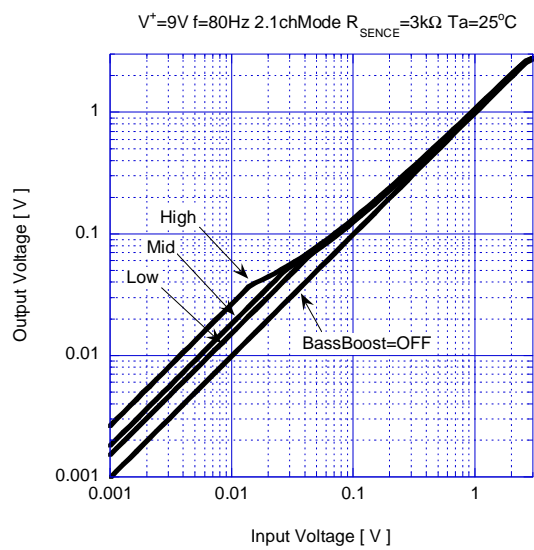

Gain vs Frequency (BB-AGCOUT, BPF)

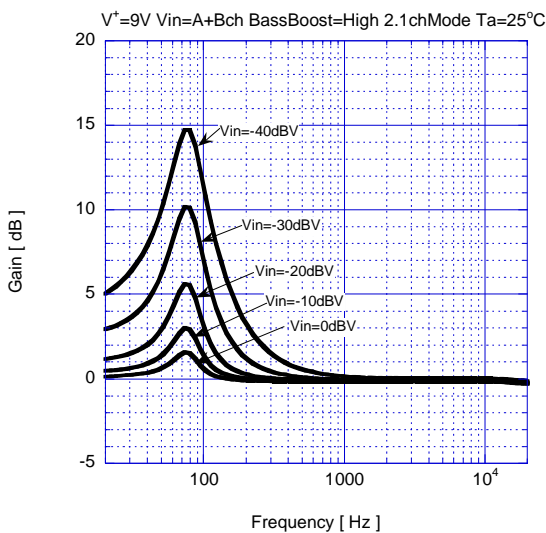

BassBoost AGC Characteristics (BPF)

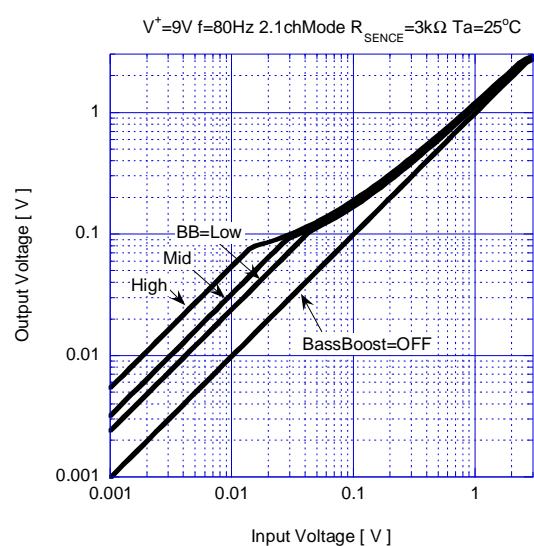

BB-AGC Attack Time

$V_{in} = 2V_{rms} \rightarrow 0.2V_{rms}$ Burst, $f = 1kHz$, AGC Level=500mV, $C_{bb} = 1\mu F$

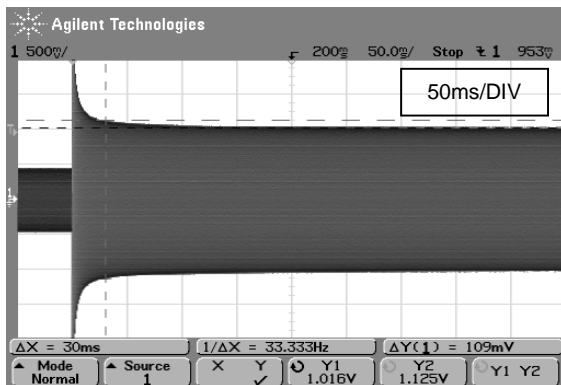

BB-AGC Recovery Time

$V_{in} = 0.2V_{rms} \rightarrow 2V_{rms}$ Burst, $f = 1kHz$, AGC Level=500mV, $C_{bb} = 1\mu F$

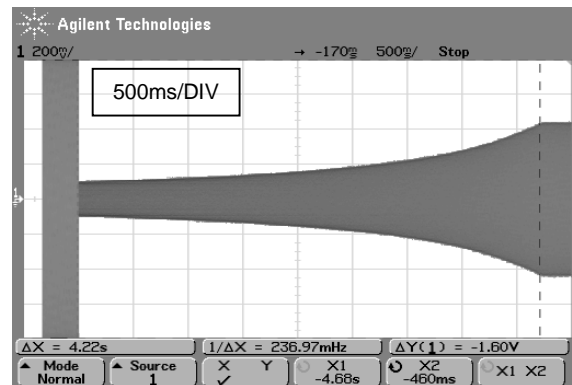

■ TYPICAL CHARACTERISTICS

Gain vs ADD1 Control

V⁺=9V ADDin1=1V f=1kHz

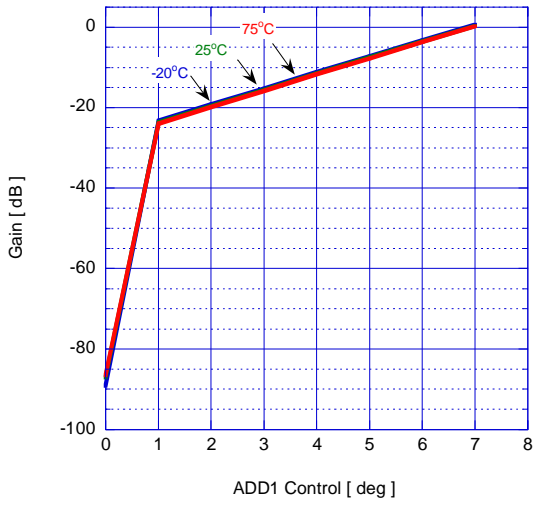

Gain vs ADD2 Control

V⁺=9V ADDin2=1V f=1kHz

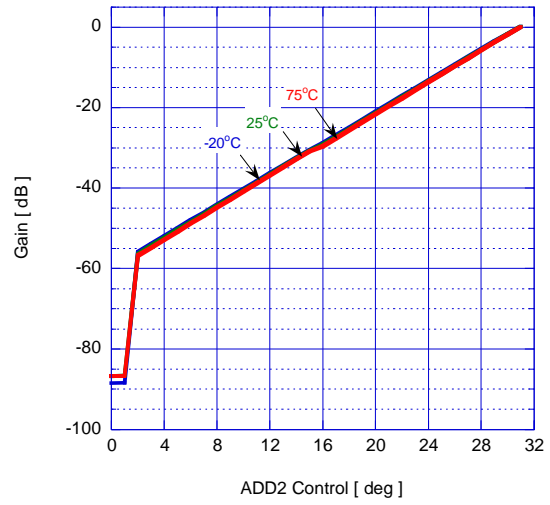

Gain vs Frequency (HighBoost)

V⁺=9V Vin=-20dBV ADDIN1="111"

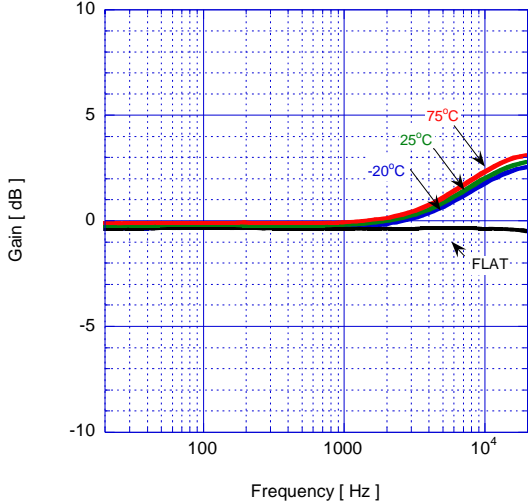

[CAUTION]
 The specifications on this databook are only given for information, without any guarantee as regards either mistakes or omissions. The application circuits in this databook are described only to show representative usages of the product and not intended for the guarantee or permission of any right including the industrial rights.