

VIDEO SWITCH FOR DVD RECORDER

■ GENERAL DESCRIPTION

The NJW1340 is a video switch for DVD recorders corresponding to the composite signal and Y/C signal.

It contains synchronous separation circuit and synchronous signal detection circuit, which are operating constantly. Therefore, It can detect a signal at the state of power save mode.

■ PACKAGE OUTLINE

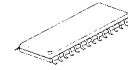

NJW1340V

■ FEATURES

- Operating Voltage 4.5 to 5.5V
- I²C BUS Interface
- 5-input 1-output video switch
- 3-input 1-output 2-circuit video switch
- 6th order Low Pass Filter
- Internal synchronous separation circuit
- Internal synchronous signal detection circuit
- Power Save Circuit
- Bi-CMOS Technology
- Package Outline SSOP32

■ BLOCK DIAGRAM

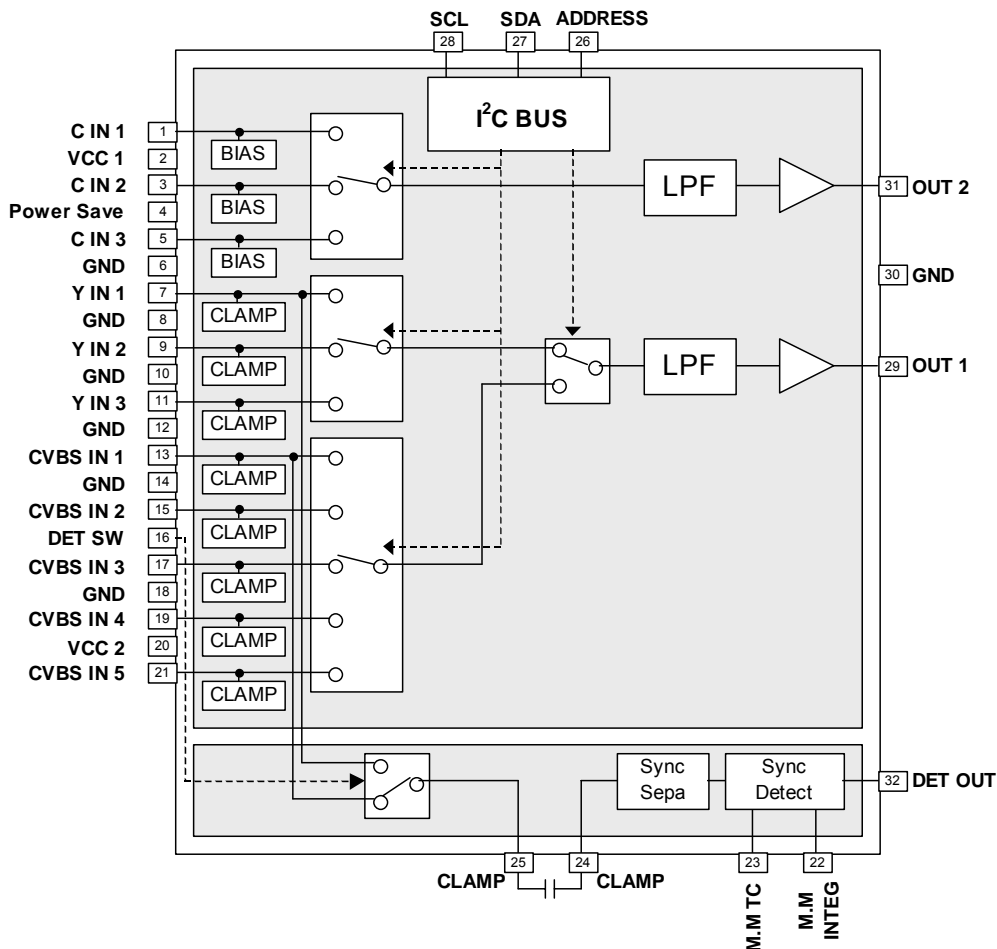

NJW1340

www.DataSheet4U.com

■ ABSOLUTE MAXIMUM RATINGS (Ta=25°C)

PARAMETER	SYMBOL	RATINGS	UNIT
Supply Voltage	V ⁺	7.0	V
Power Dissipation	P _D	800(note1)	mW
Operating Temperature Range	Topr	-40 to +85	°C
Storage Temperature Range	Tstg	-40 to +125	°C

(Note1) At on a board of EIA/JEDEC specification. (76.2 × 114.3 × 1.6mm Two layers, FR-4)

■ RECOMMENDED OPEARATING CONDITION(Ta=25°C)

PARAMETER	SYMBOL	TEST CONDITION	MIN.	TYP.	MAX.	UNIT
Operating Voltage	Vopr		4.5	5.0	5.5	V

■ ELECTRICAL CHARACTERISTICS (V⁺=5.0V, R_L=10KΩ, Ta=25°C)

PARAMETER	SYMBOL	TEST CONDITION	MIN.	TYP.	MAX.	UNIT
Operating Current	I _{cc}	No signal	-	13.0	17.0	mA
Operating Current at Power Save	I _{save}	Power Save	-	5.0	6.5	mA
Maximum Output Voltage 1	V _{om1}	CLAMP Channel Vin=100kHz, 1.0Vp-p Sin signal, THD=1%	1.6	2.6	-	Vp-p
Maximum Output Voltage 2	V _{om2}	BIAS Channel Vin=100kHz, 1.0Vp-p Sin signal, THD=1%	1.6	2.9	-	Vp-p
Voltage Gain	G _v	Vin=1MHz, 1.0Vp-p Sin signal	-0.5	0.0	0.5	dB
Frequency Characteristic 1	G _{f1}	Vin=6MHz / 100kHz, 1.0Vp-p Sin signal	-0.5	0.0	0.5	dB
Frequency Characteristic 2	G _{f2}	Vin=27MHz / 100kHz, 1.0Vp-p Sin signal	-	-40	-24	dB
Cross talk 1	CTI	Vin=4.43MHz, 1.0Vp-p Sin signal	-	-70	-	dB
Cross talk 2	CTB	Vin=4.43MHz, 1.0Vp-p Sin signal	-	-70	-	dB
Differential Gain	DG	Vin=1.0Vp-p 10step Video signal	-	0.5	-	%
Differential Phase	DP	Vin=1.0Vp-p 10step Video signal	-	0.5	-	deg
S/N	SN _v	Vin=1.0Vp-p, 100% White Video Signal	-	65	-	dB
Sync Detection Level	V _{SYNC}	Vin=10step Video signal	-	80	-	mVp-p
Capture Voltage H	V _{CAPH}	(Note2)	2.07	2.22	2.37	V
Capture Voltage L	V _{CAPL}	(Note2)	1.57	1.72	1.87	V
Lock Voltage H	V _{LOCKH}	(Note2)	2.53	2.68	2.83	V
Lock Voltage L	V _{LOCKL}	(Note2)	1.25	1.40	1.55	V
DET OUT Output Voltage H	DetH		4.9	5.0	-	V
DET OUT Output Voltage L	DetL		-	0.1	0.3	V
Switch Change Voltage H	V _{thH}		2.0	-	V ⁺	V
Switch Change Voltage L	V _{thL}		0	-	0.6	V
ADR Voltage H	V _{ADRH}		3.5	-	5.0	V
ADR Voltage L	V _{ADRL}		0	-	1.0	V
Power Save SW Inflow Current H	I _{SWPH}	V=5V	150	220	300	uA
Power Save SW Inflow Current L	I _{SWPL}	V=0.3V	4.0	7.0	11.0	uA
DET SW Inflow Current H	I _{DETH}	V=5V	80	110	150	uA
DET SW Inflow Current L	I _{DETL}	V=0.3V	0.2	2.0	6.0	uA

MODE SWITCH FUNCTION

Power Save	Mode
H	Video switch block Power Save OFF (Active)
L	Video switch block Power Save ON (Mute)
OPEN	Video switch block Power Save ON (Mute)

DET SW	Mode
H	Y IN 1 Select
L	CVBS IN 1 Select
OPEN	CVBS IN 1 Select

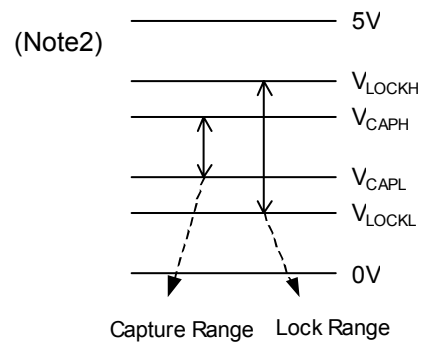

I²C BUS BLOCK CHARACTERISTICS (SDA,SCL)

I²C BUS Load Conditions

STANDARD MODE: Pull up resistance 4k Ω (Connected to +5V), Load capacitance 200pF (Connected to GND)

PARAMETER	SYMBOL	MIN	TYP	MAX	UNIT
Low Level Input Voltage	V_{IL}	0.0	-	1.5	V
High Level Input Voltage	V_{IH}	2.7	-	5.5	V
LOW level Output Voltage (3mA at SDA pin)	V_{OL}	0	-	0.4	V
Output Fall Time From V_{IHmin} to V_{ILmax} with a Bus Capacitance from 10pF to 400pF	t_{of}	-	-	250	ns
Input Current each I/O pin with an Input Voltage between 0.1 and 0.9V _{DDmax}	I_i	-10	-	10	μ A
Capacitance for each I/O pin	C_i	-	-	10	pF
SCL Clock Frequency	f_{SCL}	-	-	100	kHz
Data Transfer Start Minimum Waiting Time	$t_{HD:STA}$	4.0	-	-	μ s
Low Level Clock Pulse Width	t_{LOW}	4.7	-	-	μ s
High Level Clock Pulse Width	t_{HIGH}	4.0	-	-	μ s
Minimum Start Preparation Waiting Time	$t_{SU:STA}$	4.7	-	-	μ s
Minimum Data Hold Time	$t_{HD:DAT}$	0	-	-	μ s
Minimum Data Preparation Time	$t_{SU:DAT}$	250	-	-	ns
Rise Time	t_r	-	-	1000	ns
Fall Time	t_f	-	-	300	ns
Minimum Stop Preparation Waiting Time	$t_{SU:STO}$	4.0	-	-	μ s
Data Change Minimum Waiting Time	t_{BUF}	4.7	-	-	μ s
Capacitive load for each bus line	C_b	-	-	400	pF
Noise Margin at the Low Level	V_{nL}	0.5	-	-	V
Noise Margin at the High Level	V_{nH}	1	-	-	V

C_b ; total capacitance of one bus line in pF

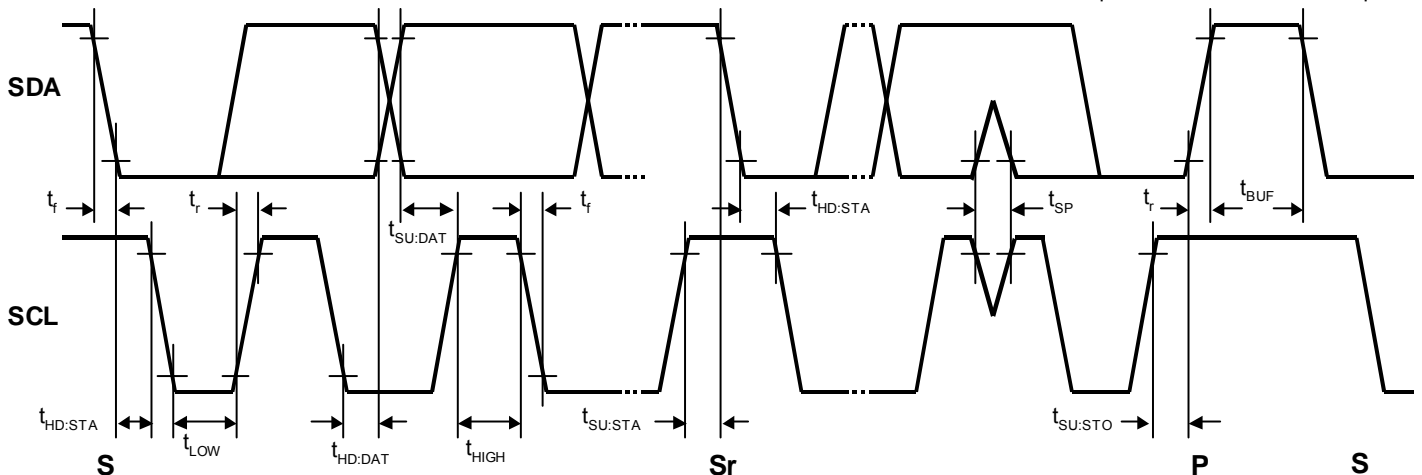

◆ I²C BUS FORMAT

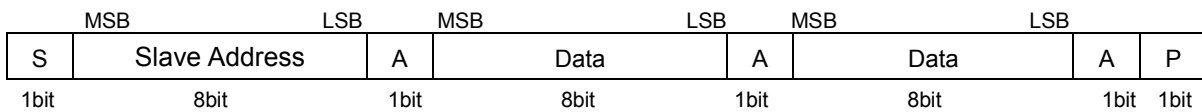

S: Starting Term

A: Acknowledge Bit

P: Ending Term

◆ SLAVE ADDRESS

R/W: Set the Write Mode or Read Mode.

ADR : Set the Slave Address by "ADR" terminal.

Slave Address								Hex
MSB						LSB		
1	0	0	0	0	0	ADR	R/W	-
◆ R/W = 0 : Write Mode, ADR = 0/1								-
1	0	0	1	0	1	0	0	94(h)
1	0	0	1	0	1	1	0	96(h)
◆ R/W = 1 : Read Mode, ADR = 0/1								-
1	0	0	1	0	1	0	1	95(h)
1	0	0	1	0	1	1	1	97(h)

◆ CONTROL REGISTER TABLE

No.	BIT							
	D7	D6	D5	D4	D3	D2	D1	D0
Data	SEL SW1	SEL SW2	SEL SW3	*	*	*	*	*

* : Don't Care

◆ CONTROL REGISTER DEFAULT VALUE

Control register default value is all "0".

No.	BIT							
	D7	D6	D5	D4	D3	D2	D1	D0
Data	0	0	0	0	0	0	0	0

■ INSTRUCTION CODE

SEL SW1	SEL SW2	SEL SW3	OUT1	OUT2
0	0	0	CVBS IN1	C IN 1
0	0	1	CVBS IN2	C IN 1
0	1	0	CVBS IN3	C IN 1
0	1	1	CVBS IN4	C IN 1
1	0	0	CVBS IN5	C IN 1
1	0	1	Y IN 1	C IN 1
1	1	0	Y IN 2	C IN 2
1	1	1	Y IN 3	C IN 3

■EQUIVALENT CIRCUIT

No.	SYMBOL	FUNCTION	INSIDE EQUIVALENT CIRCUIT	VOLTAGE
1 3 5	CIN1 CIN2 CIN3	Chroma signal input		2.8V
7 9 11 13 15 17 19 21	YIN1 YIN2 YIN3 CVBSIN1 CVBSIN2 CVBSIN3 CVBSIN4 CVBSIN5	Y signal input, YIN1 correspond to the synchronous detection at the power saving mode. Composite video signal input, CVBSIN1 correspond to the synchronous detection at the power saving mode.		2.5V
4	POWER SAVE	Power Save control		
16	DETSW	Signal detection control, Y IN1 or CVBS IN1		

NJW1340

No.	SYMBOL	FUNCTION	INSIDE EQUIVALENT CIRCUIT	VOLTAGE
22	MMINTEG	Capacitor connection for smoothing mono multi.		
23	MMTC	Capacitor and resistance connection for mono multi time constant. The accuracy of external resistance recommends within $\pm 5\%$.		
24	CLAMP	Capacitor connection for CLAMP		0.9V
25	CLAMP	Capacitor connection for CLAMP		1.3V

No.	SYMBOL	FUNCTION	INSIDE EQUIVALENT CIRCUIT	VOLTAGE
26	SCL	I ² C clock		
27	SDA	I ² C data		
28	ADDRESS	Slave address setting		
29 31	OUT1 OUT2	Composite video signal, Y signal output Chroma signal output		0.9V 2.0V

NJW1340

www.DataSheet4U.com

No.	SYMBOL	FUNCTION	INSIDE EQUIVALENT CIRCUIT	VOLTAGE
29	DETOUT	Detection signal output. The synchronous detection result output at the power saving mode.		
6 8 10 12 14 18 30	GND	GND		
20	VCC1 VCC2	Vcc		

TEST CIRCUIT

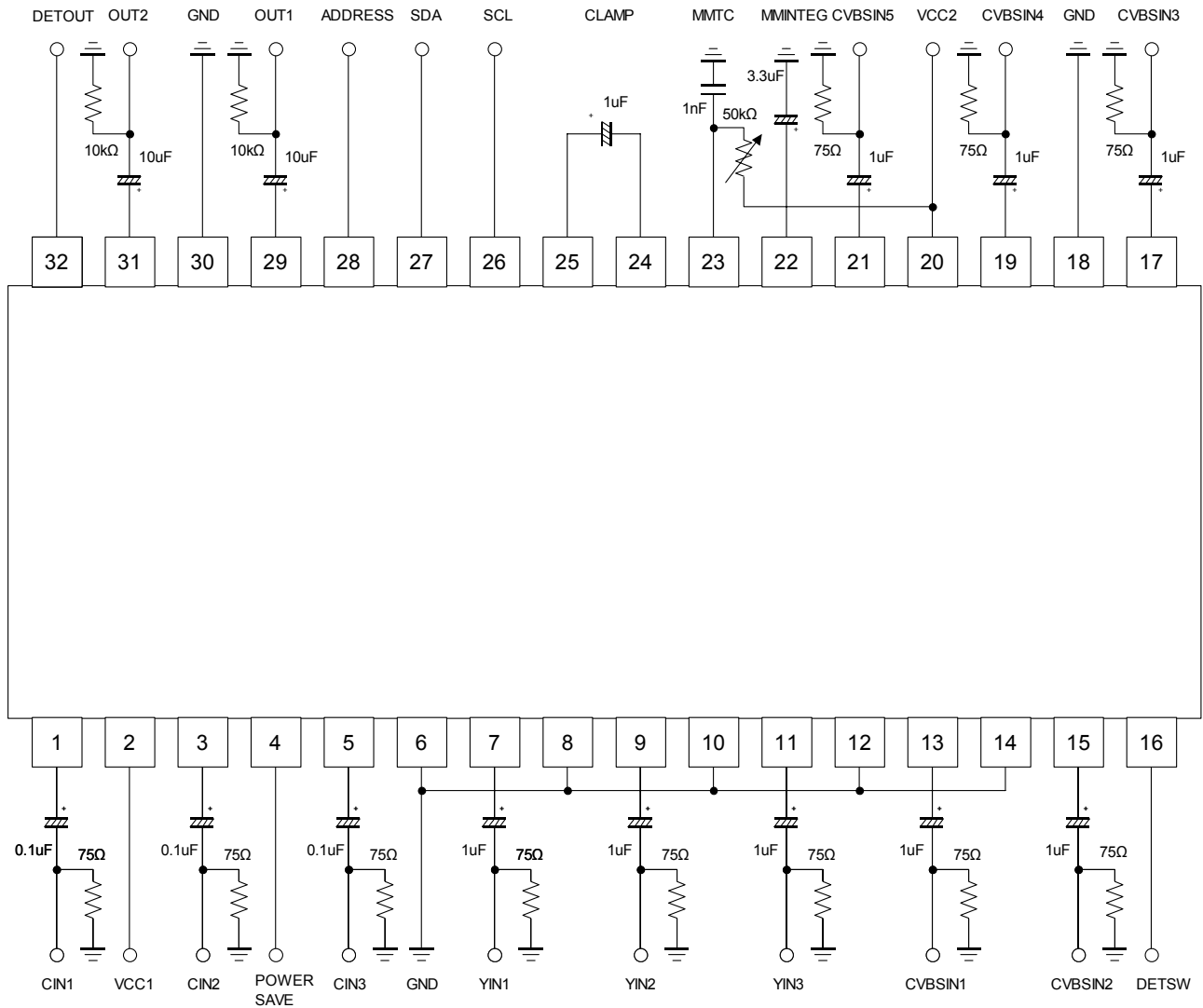

(Note) It the following refers when the synchronous signal detection unused.

- | | |
|---------------|------|
| 16pin DETSW | OPEN |
| 22pin MMINTEG | OPEN |
| 23pin MMTC | OPEN |
| 24pin CLAMP | OPEN |
| 25pin CLAMP | OPEN |
| 32pin DETOUT | OPEN |

■ TYPICAL CHARACTERISTICS

Voltage Gain vs Frequency

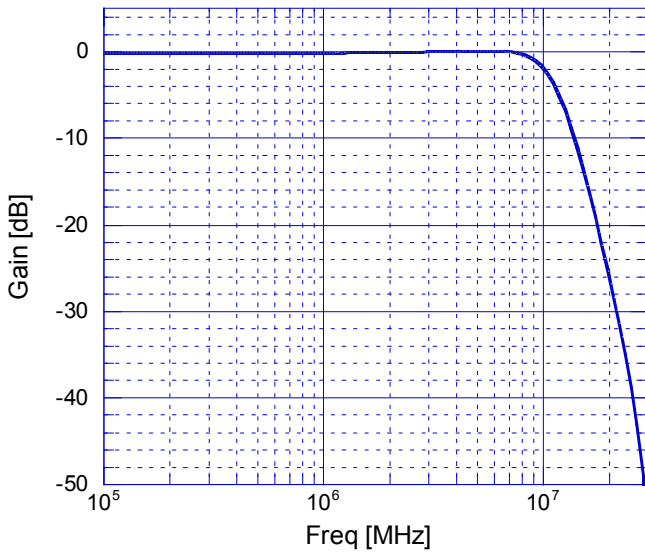

[CAUTION]
The specifications on this databook are only given for information, without any guarantee as regards either mistakes or omissions. The application circuits in this databook are described only to show representative usages of the product and not intended for the guarantee or permission of any right including the industrial rights.