

High Voltage Low current consumption Regulator

■ GENERAL DESCRIPTION

The NJW4180 is a high voltage and low current consumption linear regulator.

Low current consumption make the NJW4180 possible to supply 2.5 to 5.0 V regulated voltage from high voltage input.

Therefore, it is suitable for a power supply for micro controllers, battery related applications, LED and other applications where low power consumption is essential.

■ PACKAGE OUTLINE

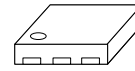

NJW4180KG1

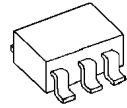

NJW4180F

■ FEATURES

- Operating Voltage Range 35V (max.)
- Low Current Consumption 9 μ A (typ.)
- MLCC correspond
- Output Current $I_O(\text{min.})=20\text{mA}$
- High Precision Output $V_O \pm 1.5\%$
- Internal Thermal Overload Protection
- Internal Over Current Protection
- Internal Reverse Current Protection
- Package Outline ESON6-G1, SOT23-5

■ PIN CONNECTION

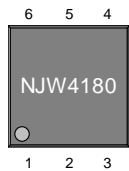

NJW4180KG1

PIN CONFIGURATION

1. N.C.
2. GND
3. N.C.
4. V_{IN}
5. N.C.
6. V_{OUT}

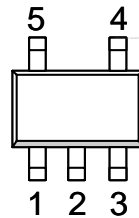

NJW4180F

PIN CONFIGURATION

1. N.C.
2. GND
3. N.C.
4. V_{OUT}
5. V_{IN}

■ BLOCK DIAGRAM

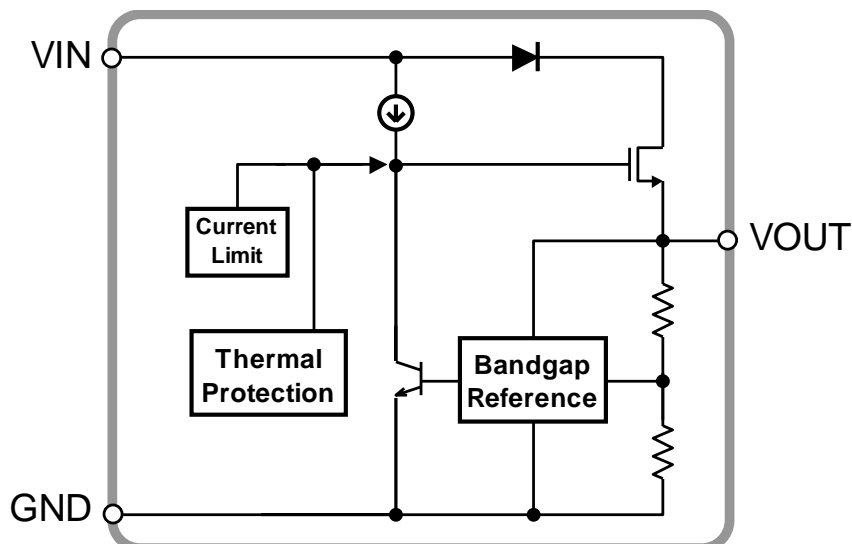

NJW4180

■ OUTPUT VOLTAGE LANK LIST

Device Name	V _{OUT}	Device Name	V _{OUT}
NJW4180F25	2.5V	NJW4180KG1-25	2.5V
NJW4180F33	3.3V	NJW4180KG1-33	3.3V
NJW4180F05	5.0V	NJW4180KG1-05	5.0V

■ ABSOLUTE MAXIMUM RATINGS (Ta=25°C)

PARAMETER	SYMBOL	RATINGS	UNIT	
Input Voltage	V _{IN}	+40	V	
Output Voltage	V _{OUT}	+7	V	
Power Dissipation	P _D	ESON6-G1	330 (*1)	mW
			905 (*2)	
		SOT-23-5	390 (*3)	
			520 (*4)	
Operating Temperature	Topr	-40 to +85	°C	
Storage Temperature	Tstg	-50 to +125	°C	

(*1): Mounted on glass epoxy board based on EIA/JEDEC STANDARD.

(101.5×114.5×1.6mm: 2Layers with Exposed Pad FR-4)

(*2): Mounted on glass epoxy board based on EIA/JEDEC STANDARD.

(101.5×114.5×1.6mm: 4Layers with Exposed Pad FR-4, Internal foil area size: 99.5×99.5mm, Applying a thermal via hole to a board based on JEDEC standard JESD51-5)

(*3): Mounted on glass epoxy board based on EIA/JEDEC. (114.3×76.2×1.6mm: 2Layers FR-4)

(*4): Mounted on glass epoxy board based on EIA/JEDEC. (114.3×76.2×1.6mm: 4Layers FR-4)

■ PROTECTION CIRCUIT

Over Current Protection

Thermal Shutdown

Reverse Current Protection

■ INPUT VOLTAGE RANG

V_O≤3V: V_{IN} = +5.5V to +35V

V_O>3V: V_{IN} = V_O+2.5V to +35V

■ ELECTRICAL CHARACTERISTICS

(Unless otherwise specified, $V_{IN}=V_O+2.5V$ ($V_O \leq 3V$: $V_{IN}=5.5V$), $C_{IN}=0.1 \mu F$, $C_O=1 \mu F$, $T_a=25^\circ C$)

PARAMETER	SYMBOL	TEST CONDITION	MIN.	TYP.	MAX.	UNIT
Output Voltage	V_O	$I_O=10mA$	-1.5%	-	+1.5%	V
Quiescent Current	I_Q	$I_O=0mA$	-	9	15	μA
Output Current	I_O	$V_O \times 0.9$	20	30	-	mA
Line Regulation	$\Delta V_O / \Delta V_{IN}$	$V_{IN} = 5.5V$ to $35V$, $I_O=10mA$ ($V_O \leq 3V$) $V_{IN} = V_O+2.5V$ to $35V$, $I_O=10mA$ ($V_O > 3V$)	-	0.02	0.05	%/V
Load Regulation	$\Delta V_O / \Delta I_O$	$I_O=0mA$ to $20mA$	-	0.005	0.02	%/mA
Average Temperature Coefficient of Output Voltage	$\Delta V_O / \Delta T_a$	$T_a=0$ to $85^\circ C$, $I_O=10mA$	-	± 100	-	ppm/ $^\circ C$
Sink Current under Reverse Current Protection operating	$I_{REVERSE}$	$V_{IN} = 0V$, $V_O = 5V$	-	50	75	μA
Input Voltage	V_{IN}	$V_O \leq 3V$	5.5	-	35	V
		$V_O > 3V$	$V_O+2.5$	-	35	

The above specification is a common specification for all output voltages.

Therefore, it may be different from the individual specification for a specific output voltage.

POWER DISSIPATION vs. AMBIENT TEMPERATURE

NJW4180KG1 Power Dissipation
($T_{opr}=-40\sim+85^{\circ}\text{C}$, $T_j=125^{\circ}\text{C}$)

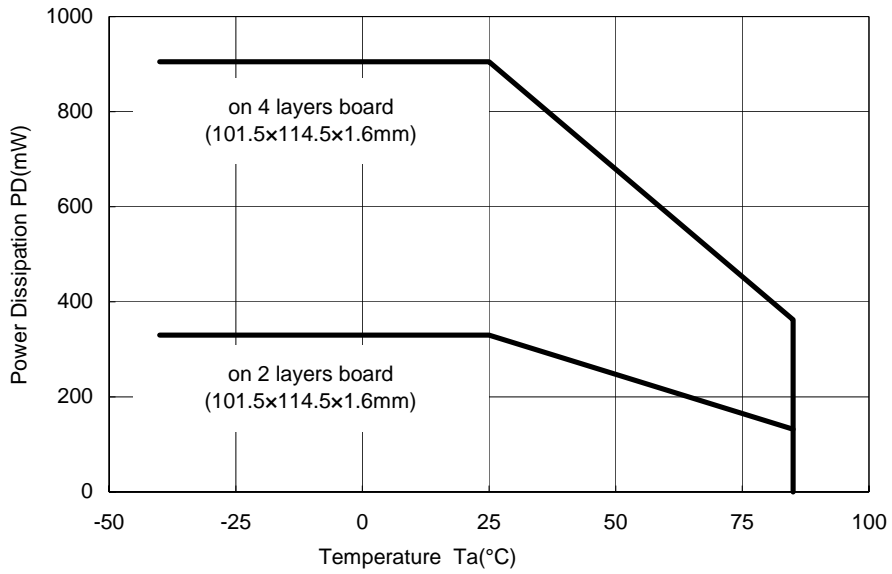

NJW4180F Power Dissipation
($T_{opr}=-40\sim+85^{\circ}\text{C}$, $T_j=125^{\circ}\text{C}$)

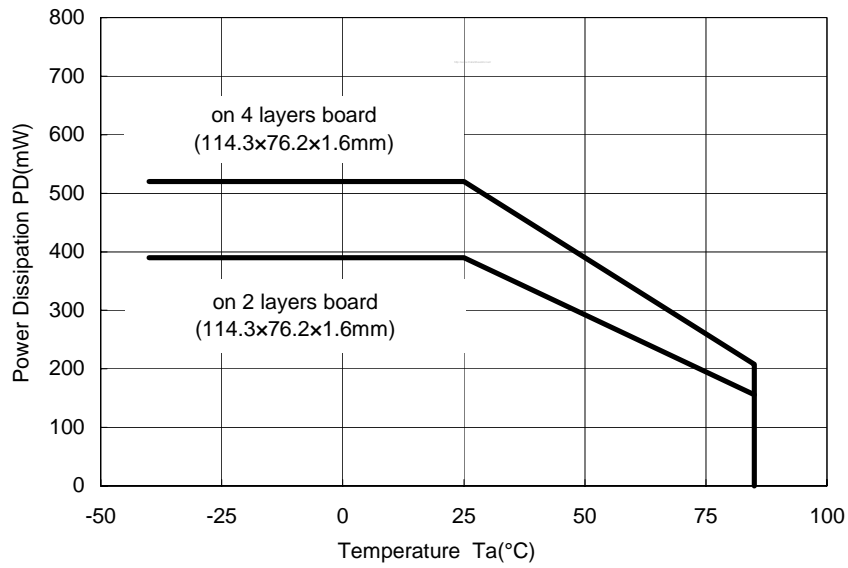

■ TEST CIRCUIT

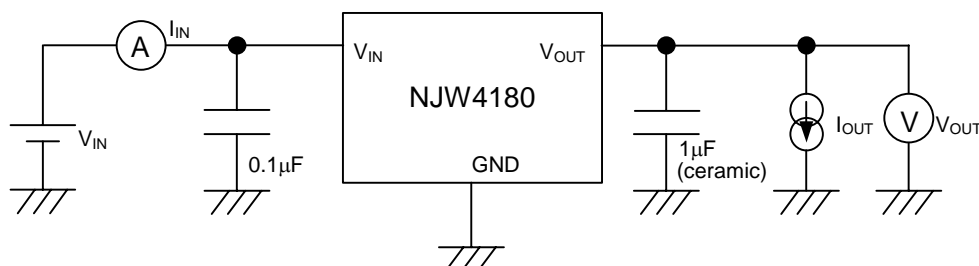

■ TYPICAL APPLICATION

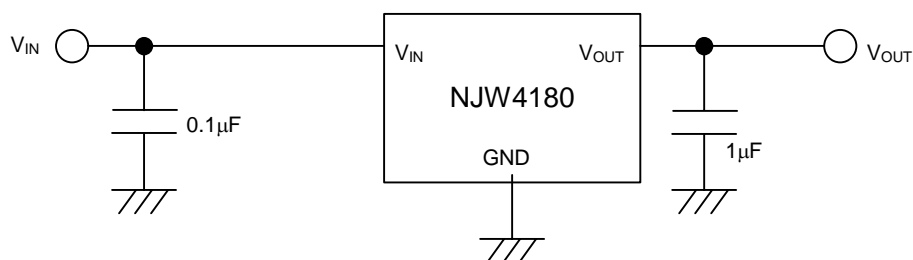

*Input Capacitance C_{IN}

Input Capacitance (C_{IN}) is required to prevent oscillation and reduce power supply ripple for applications with high power supply impedance or a long power supply line.

Use the C_{IN} value of $0.1\mu\text{F}$ greater to avoid the problem.

C_{IN} should connect between GND and V_{IN} as short as possible.

*Output Capacitance C_O

Output capacitor (C_O) is required for a phase compensation of the internal error amplifier. The capacitance and the equivalent series resistance (ESR) influences stability of the regulator.

This product is designed to work with a low ESR capacitor for the C_O ; however, use of recommended capacitance or greater value is essential for stable operation.

Use of a smaller C_O may cause excess output noise or oscillation of the regulator due to lack of the phase compensation.

Therefore, use C_O with the recommended capacitance or greater value and connect between V_O terminal and GND terminal with minimal wiring. The recommended capacitance depends on the output voltage. Low voltage regulator requires greater value of the C_O . Thus, check the recommended capacitance for each output voltage.

Use of a greater C_O reduces output noise and ripple output, and also improves transient response of the output voltage against rapid load change.

TYPICAL CHARACTERISTICS

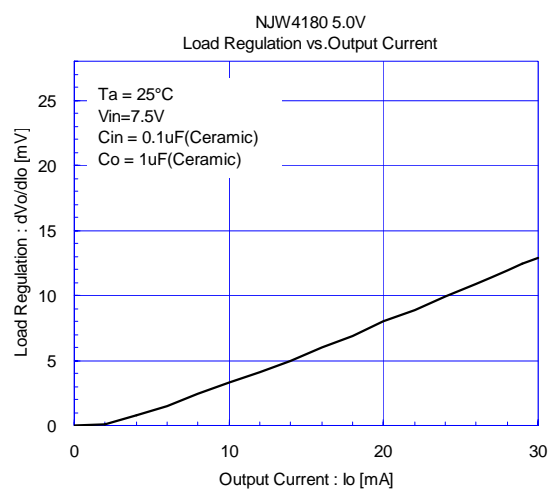
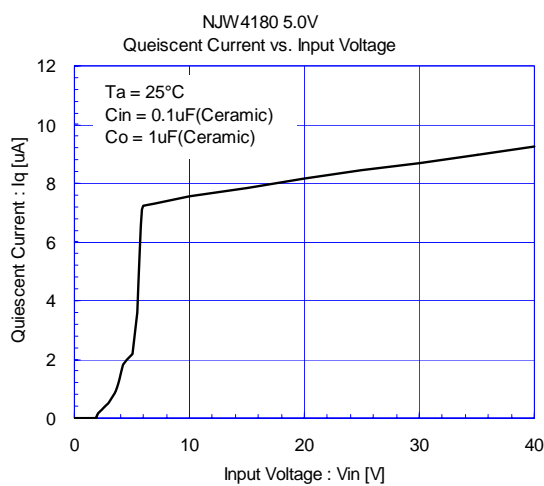
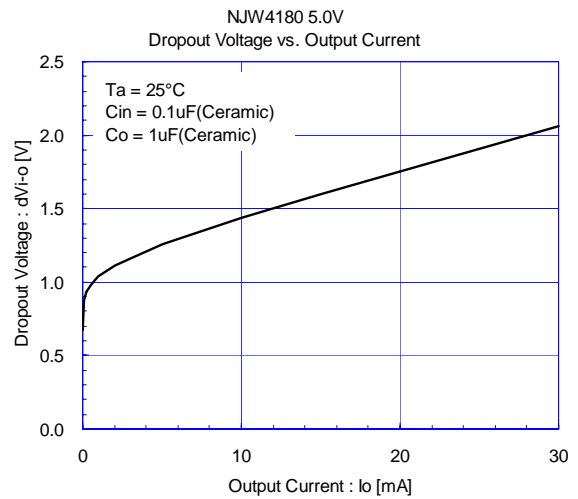
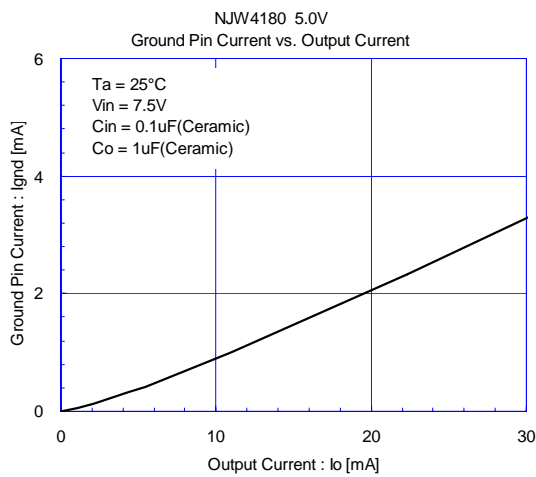
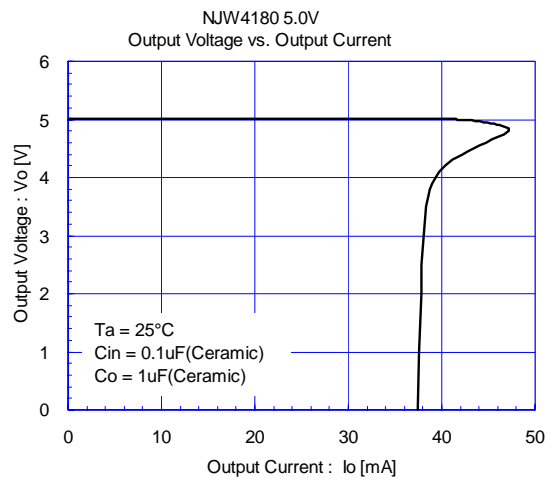
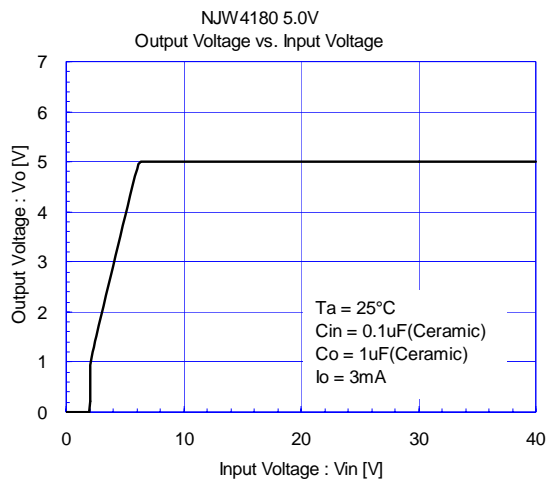

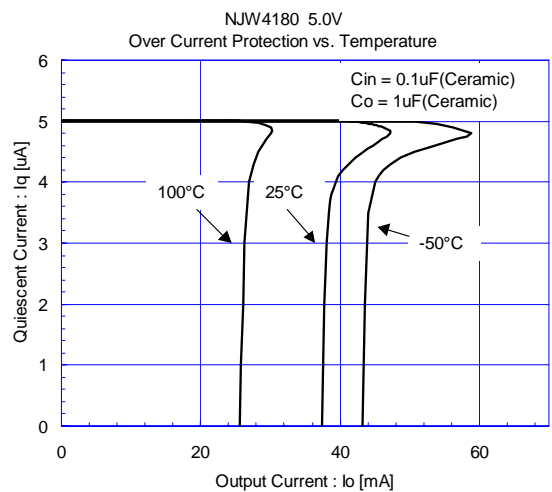
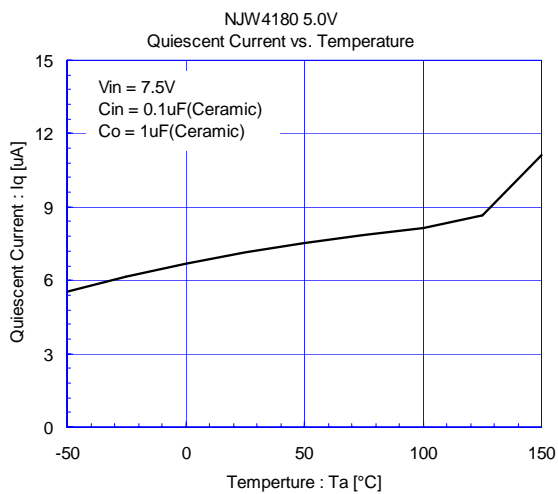
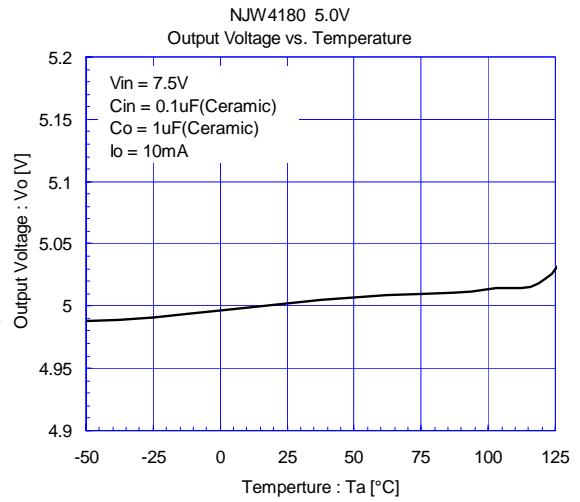
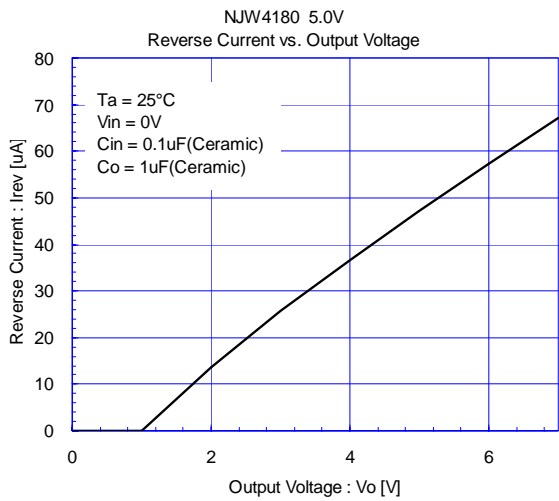
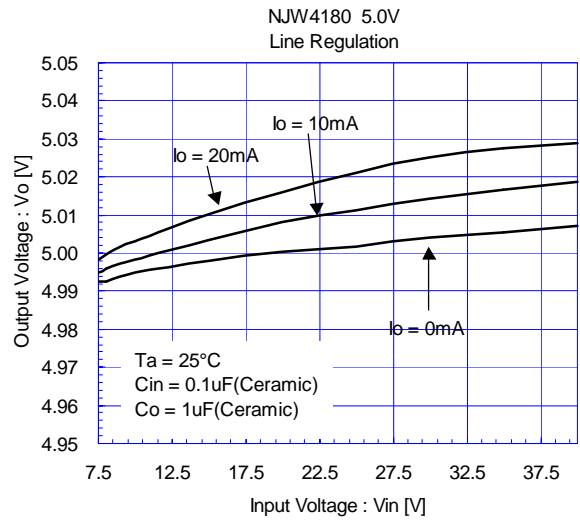
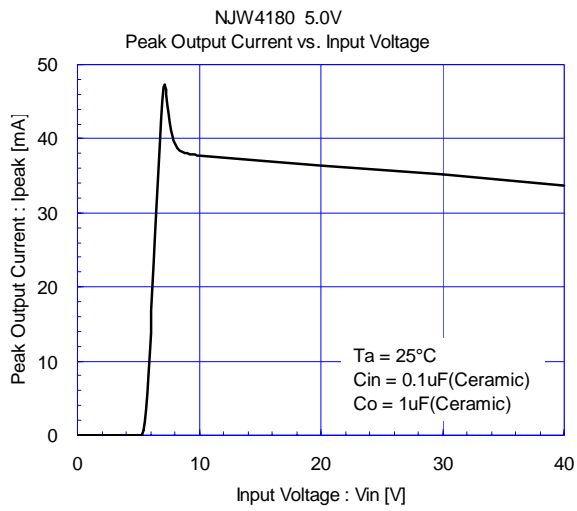

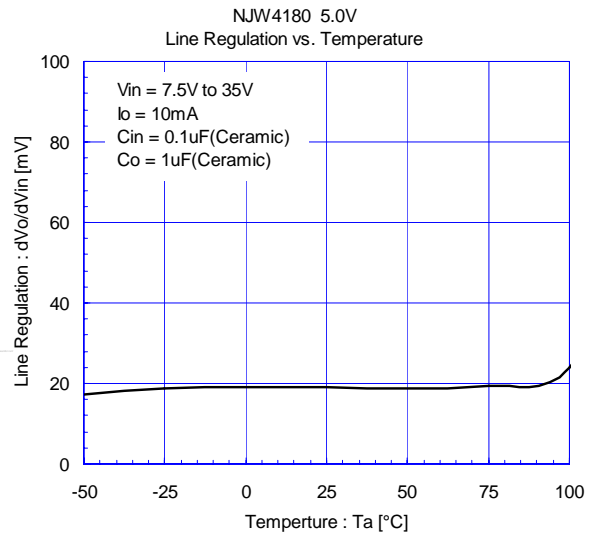
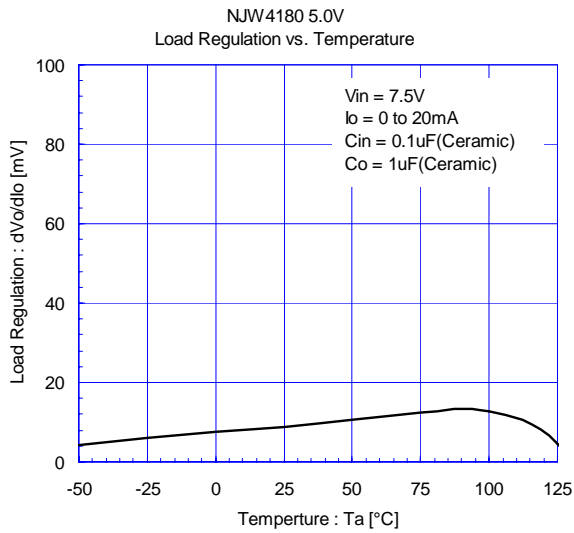
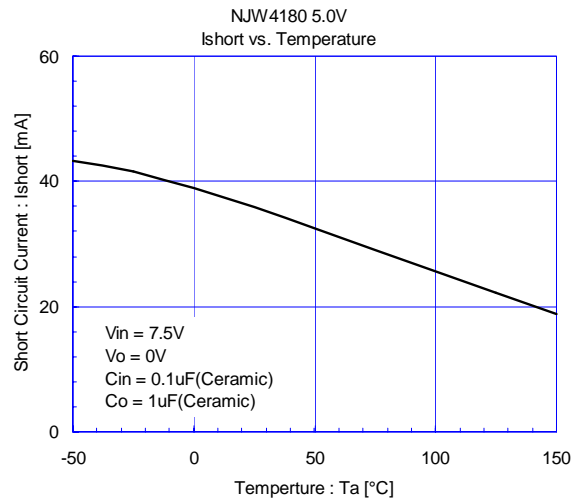
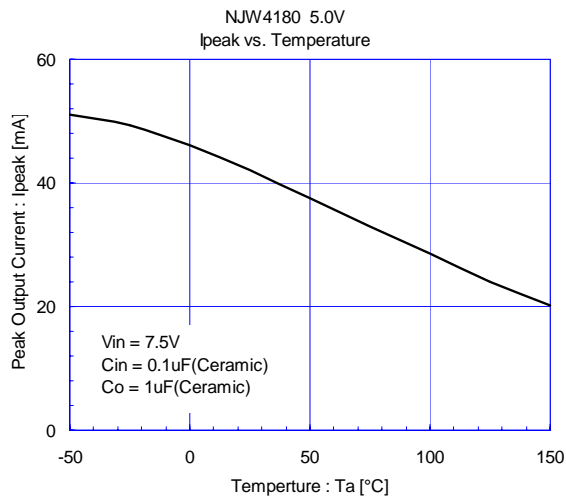

[CAUTION]

The specifications on this databook are only given for information, without any guarantee as regards either mistakes or omissions. The application circuits in this databook are described only to show representative usages of the product and not intended for the guarantee or permission of any right including the industrial rights.