

PRELIMINARY

NEC NEC LCD Technologies, Ltd.

TFT COLOR LCD MODULE

NL10276BC24-14

31cm (12.1 Type)

XGA

LVDS interface (1port)

PRELIMINARY DATA SHEET 

DOD-PP-0048 (1st edition)

**All information is subject to change without notice.
Please confirm the sales representative before
starting to design your system.**

INTRODUCTION

The Copyright to this document belongs to NEC LCD Technologies, Ltd. (hereinafter called "NEC"). No part of this document will be used, reproduced or copied without prior written consent of NEC.

NEC does and will not assume any liability for infringement of patents, copyrights or other intellectual property rights of any third party arising out of or in connection with application of the products described herein except for that directly attributable to mechanisms and workmanship thereof. No license, express or implied, is granted under any patent, copyright or other intellectual property right of NEC.

Some electronic parts/components would fail or malfunction at a certain rate. In spite of every effort to enhance reliability of products by NEC, the possibility of failures and malfunction might not be avoided entirely. To prevent the risks of damage to death, human bodily injury or other property arising out thereof or in connection therewith, each customer is required to take sufficient measures in its safety designs and plans including, but not limited to, redundant system, fire-containment and anti-failure.

The products are classified into three quality grades: "**Standard**", "**Special**", and "**Specific**" of the highest grade of a quality assurance program at the choice of a customer. Each quality grade is designed for applications described below. Any customer who intends to use a product for application other than that of Standard quality grade is required to contact an NEC sales representative in advance.

The **Standard** quality grade applies to the products developed, designed and manufactured in accordance with the NEC standard quality assurance program, which are designed for such application as any failure or malfunction of the products (sets) or parts/components incorporated therein a customer uses are, directly or indirectly, free of any damage to death, human bodily injury or other property, like general electronic devices.

Examples: Computers, office automation equipment, communications equipment, test and measurement equipment, audio and visual equipment, home electronic appliances, machine tools, personal electronic equipment, industrial robots, etc.

The **Special** quality grade applies to the products developed, designed and manufactured in accordance with an NEC quality assurance program stricter than the standard one, which are designed for such application as any failure or malfunction of the products (sets) or parts/components incorporated therein a customer uses might directly cause any damage to death, human bodily injury or other property, or such application under more severe condition than that defined in the Standard quality grade without such direct damage.

Examples: Control systems for transportation equipment (automobiles, trains, ships, etc.), traffic control systems, anti-disaster systems, anti-crime systems, medical equipment not specifically designed for life support, safety equipment, etc.

The **Specific** quality grade applies to the products developed, designed and manufactured in accordance with the standards or quality assurance program designated by a customer who requires an extremely higher level of reliability and quality for such products.

Examples: Military systems, aircraft control equipment, aerospace equipment, nuclear reactor control systems, medical equipment/devices/systems for life support, etc.

The quality grade of this product is the "**Standard**" unless otherwise specified in this document.

PRELIMINARY

CONTENTS

INTRODUCTION	2
1. OUTLINE	4
1.1 STRUCTURE AND PRINCIPLE	4
1.2 APPLICATION	4
1.3 FEATURES	4
2. GENERAL SPECIFICATIONS	5
3. BLOCK DIAGRAM	6
4. DETAILED SPECIFICATIONS	8
4.1 MECHANICAL SPECIFICATIONS	8
4.2 ABSOLUTE MAXIMUM RATINGS	8
4.3 ELECTRICAL CHARACTERISTICS	9
4.3.1 LCD panel signal processing board	9
4.3.2 Backlight	10
4.3.3 Power supply voltage ripple	10
4.3.4 Fuse	10
4.4 POWER SUPPLY VOLTAGE SEQUENCE	11
4.5 CONNECTIONS AND FUNCTIONS FOR INTERFACE PINS	12
4.6 POSITION OF PLUG AND SOCKET	13
4.7 CONNECTION BETWEEN RECEIVER AND TRANSMITTER FOR LVDS	14
4.8 LVDS DATA INPUT MAP	15
4.9 DISPLAY COLORS AND DATA SIGNALS	16
4.10 DISPLAY POSITIONS	17
4.11 SCANNING DIRECTIONS	17
4.12 INPUT SIGNAL TIMINGS	18
4.12.1 Outline of input signal timings	18
4.12.2 Timing characteristics	19
4.12.3 Input signal timing chart	20
4.13 OPTICS	21
4.13.1 Optical characteristics	21
4.13.2 Definition of contrast ratio	22
4.13.3 Definition of luminance uniformity	22
4.13.4 Definition of response times	22
4.13.5 Definition of viewing angles	22
5. RELIABILITY TESTS	23
6. PRECAUTIONS	24
6.1 MEANING OF CAUTION SIGNS	24
6.2 CAUTIONS	24
6.3 ATTENTIONS	24
6.3.1 Handling of the product	24
6.3.2 Environment	25
6.3.3 Characteristics	25
6.3.4 Other	25
7. OUTLINE DRAWINGS	26
7.1 FRONT VIEW	26
7.2 REAR VIEW	27
REVISION HISTORY	28

1. OUTLINE

1.1 STRUCTURE AND PRINCIPLE

Color LCD module NL10276BC24-14 is composed of the amorphous silicon thin film transistor liquid crystal display (a-Si TFT LCD) panel structure with driver LSIs for driving the TFT (Thin Film Transistor) array and a backlight.

The a-Si TFT LCD panel structure is injected liquid crystal material into a narrow gap between the TFT array glass substrate and a color-filter glass substrate.

Color (Red, Green, Blue) data signals from a host system (e.g. signal generator, etc.) are modulated into best form for active matrix system by a signal processing board, and sent to the driver LSIs which drive the individual TFT arrays.

The TFT array as an electro-optical switch regulates the amount of transmitted light from the backlight assembly, when it is controlled by data signals. Color images are created by regulating the amount of transmitted light through the TFT array of red, green and blue dots.

1.2 APPLICATION

- NOTE PC

1.3 FEATURES

- LVDS interface
- Reversible-scan direction
- LED backlight type

2. GENERAL SPECIFICATIONS

<i>Display area</i>	245.76 (H) × 184.32 (V) mm
<i>Diagonal size of display</i>	31cm (12.1 inches)
<i>Drive system</i>	a-Si TFT active matrix
<i>Display color</i>	262,144 colors
<i>Pixel</i>	1,024 (H) × 768 (V) pixels
<i>Pixel arrangement</i>	BGR(Blue dot, Green dot, Red dot) vertical stripe
<i>Dot pitch</i>	0.08 (H) × 0.24 (V) mm
<i>Pixel pitch</i>	0.24 (H) × 0.24 (V) mm
<i>Module size</i>	260.0 (W) × 200.0 (H) × 6.5 (D) mm (typ.)
<i>Weight</i>	285 g (typ.)
<i>Contrast ratio</i>	600:1 (typ.)
<i>Viewing angle</i>	At the contrast ratio $\geq 10:1$ <ul style="list-style-type: none"> • Horizontal: Right side 45° (typ.), Left side 45° (typ.) • Vertical: Up side 20° (typ.), Down side 40° (typ.)
<i>Designed viewing direction</i>	At DPS= Low or open: normal scan <ul style="list-style-type: none"> • Viewing direction without image reversal: up side (12 o'clock) • Viewing direction with contrast peak: down side (6 o'clock) • Viewing angle with optimum grayscale ($\gamma=2.2$): normal axis (Perpendicular)
<i>Polarizer surface</i>	Clear
<i>Polarizer pencil-hardness</i>	3H (min.) [by JIS K5400]
<i>Color gamut</i>	At LCD panel center 40 % (typ.) [against NTSC color space]
<i>Response time</i>	Ton+Toff (10%←→90%) 25 ms (typ.)
<i>Luminance</i>	At IL=20mA 300 cd/m ² (typ.)
<i>Signal system</i>	LVDS 1port (Receiver: THC63LVDF84B, THine Electronics Inc. or equivalent) 6bit digital signals for data of RGB colors, Dot clock (CLK), Data enable (DE)
<i>Power supply voltage</i>	LCD panel signal processing board: 3.3V
<i>Backlight</i>	LED backlight type:
<i>Power consumption</i>	At IL=20mA, Checkered flag pattern 4.5 W (typ.)

3. BLOCK DIAGRAM

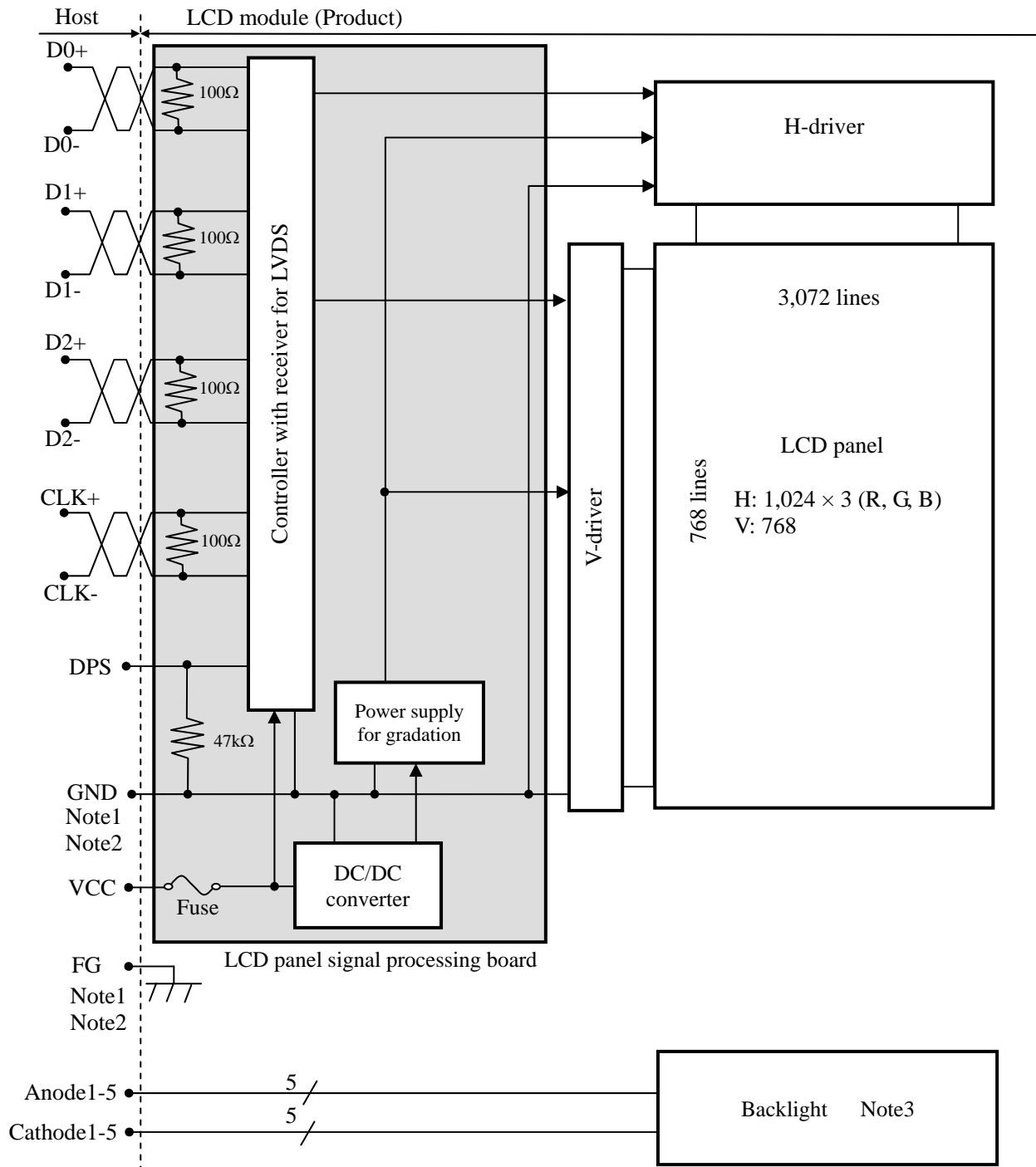

Note1: Relations between GND (Signal ground), FG (Frame ground) in the LCD module are as follows.

GND - FG	Not connected
----------	---------------

Note2: GND and FG must be connected to customer equipment's ground, and it is recommended that these grounds are connected together in customer equipment.

PRELIMINARY

Note3: Backlight in detail

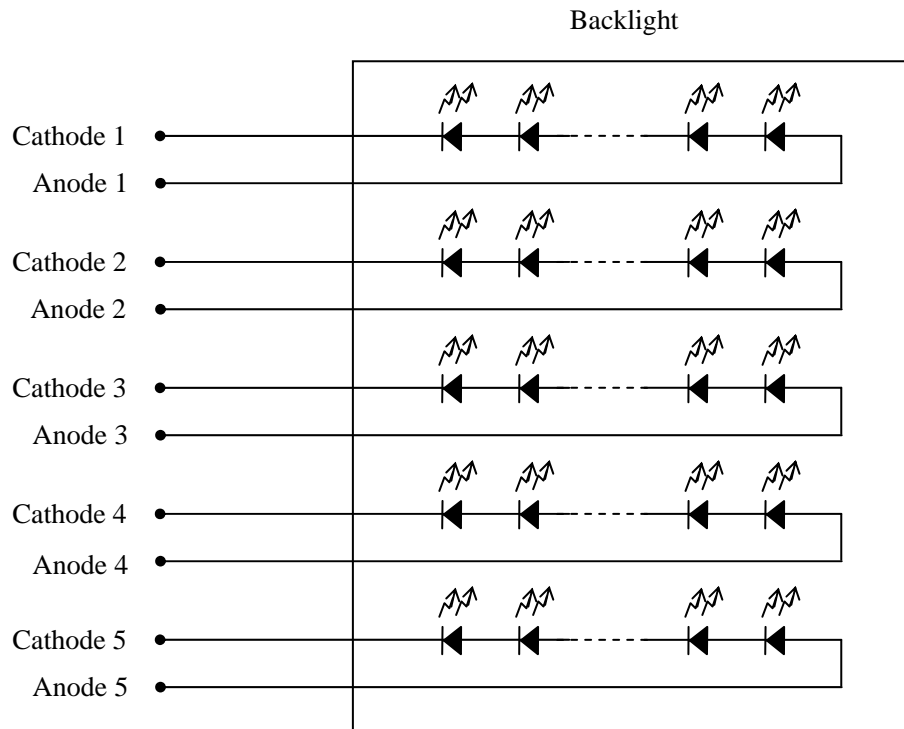

PRELIMINARY

4. DETAILED SPECIFICATIONS

4.1 MECHANICAL SPECIFICATIONS

Parameter	Specification	Unit
Module size	260.0 (W) × 200.0 (H) × 6.5 (D) (typ) Note1	mm
Display area	245.76 (H) × 184.32 (V) Note1	mm
Weight	285 (typ.), 300 (max.)	g

Note1: See "7. OUTLINE DRAWINGS".

4.2 ABSOLUTE MAXIMUM RATINGS

Parameter	Symbol	Rating	Unit	Remarks	
Power supply voltage	LCD panel signal processing board	VCC	-0.3 to +4.0	V	-
Input voltage for signals	Display signals Note1	VD	-0.3 to VCC+0.3	V	
	Function signal Note2	VF			
Backlight	Power dissipation	PD	1.1	W	per one circuit
	Forward current	IL	Note3	mA	
	Pulse forward current	IFP	Note4	mA	
Storage temperature		Tst	-20 to +60	°C	-
Operating temperature		Top	0 to +55	°C	Note5
Relative humidity Note6		RH	≤ 95	%	Ta ≤ 40°C
			≤ 85	%	40°C < Ta ≤ 50°C
			≤ 70	%	50°C < Ta ≤ 55°C
Absolute humidity Note6		AH	≤ 73 Note7	g/m ³	Ta > 55°C

Note1: Display signals are D0+/-, D1+/-, D2+/- and CLK+/-.

Note2: Function signal 1 is DPS.

PRELIMINARY

Note3: Forward current

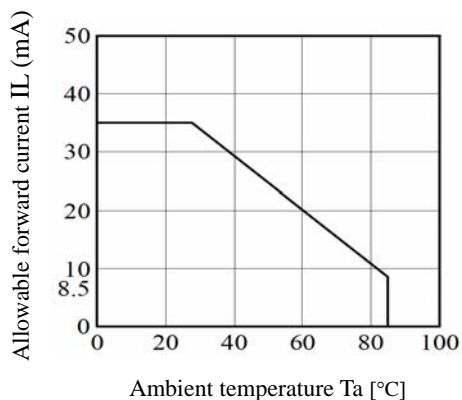

Note4: Pulse forward current

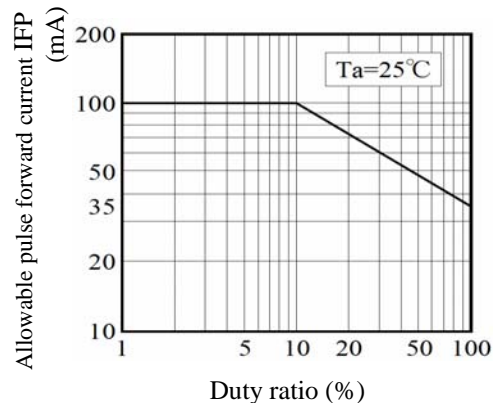

Note5: Measured at center of LCD panel surface (including self-heat)

Note6: No condensation

Note7: Water amount at Ta = 55°C and RH = 70%

4.3 ELECTRICAL CHARACTERISTICS

4.3.1 LCD panel signal processing board

(Ta = 25°C)

Parameter	Symbol	min.	typ.	max.	Unit	Remarks	
Power supply voltage	VCC	3.0	3.3	3.6	V	-	
Power supply current	ICC	-	480 Note1	770 Note2	mA	at VCC = 3.3V	
Permissible ripple voltage	VRP	-	-	100	mVp-p	for VCC	
Differential input threshold voltage for LVDS receiver	High	VTH	-	-	+100	mV	at VCM=1.2V Note3
	Low	VTL	-100	-	-	mV	
Terminating resistance	RT	-	100	-	Ω	-	
Input voltage for DPS signals	High	VFH	0.7VCC	-	VCC	V	CMOS level
	Low	VFL	0	-	0.3VCC	V	

Note1: Checkered flag pattern [by EIAJ ED-2522]

Note2: Pattern for maximum current

Note3: Common mode voltage for LVDS receiver

PRELIMINARY

4.3.2 Backlight

(Ta= 25°C)

Parameter	Symbol	min.	typ.	max.	Unit	Remarks
Forward current	IL	-	20	22	mA	-
Forward Voltage	VL	-	28.8	31.5	V	at IL= 20mA

Note1: Please drive with constant current .

Note2: The Luminance uniformity may be changed depending on the current variation between 5 circuits.
It is recommended that the current value difference between each circuit is less than 5%.

4.3.3 Power supply voltage ripple

This product works, even if the ripple voltage levels are beyond the permissible values as following the table, but there might be noise on the display image.

Power supply voltage	Ripple voltage (Measure at input terminal of power supply)	Unit
VCC	3.3V	≤ 100 mVp-p

Note1: The permissible ripple voltage includes spike noise.

4.3.4 Fuse

Parameter	Fuse		Rating	Fusing current	Remarks
	Type	Supplier			
VCC	FCC16202AB	KAMAYA ELECTRIC Co.,Ltd.	2.0A	4.0A	Note1
			32V		

Note1: The power supply capacity should be more than the fusing current. If it is less than the fusing current, the fuse may not blow in a short time, and then nasty smell, smoke and so on may occur.

4.4 POWER SUPPLY VOLTAGE SEQUENCE

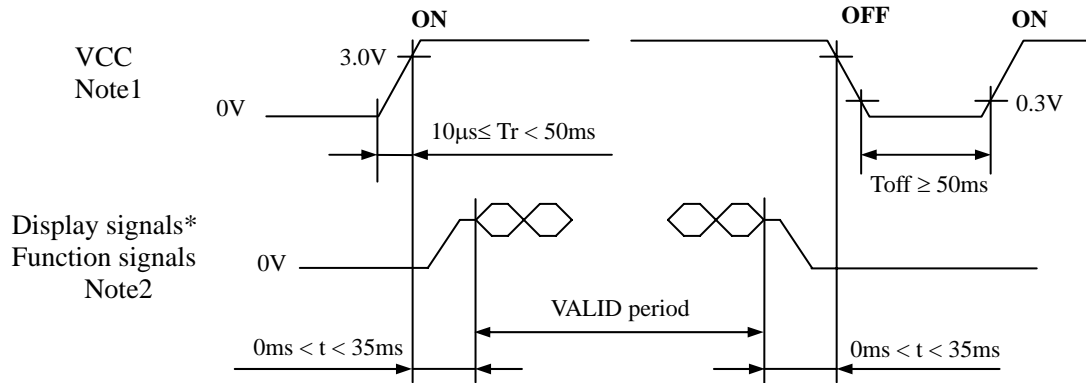

* These signals should be measured at the terminal of 100Ω resistance.

Note1: In terms of voltage variation (voltage drop) while VCC rising edge is below 3.0V, a protection circuit may work, and then this product may not work.

Note2: Display signals (D0+/-, D1+/-, D2+/- and CLK+/-) and function signals (DPS) must be Low or High-impedance, exclude the VALID period (See above sequence diagram), in order to avoid that internal circuits is damaged.

If some of display and function signals of this product are cut while this product is working, even if the signal input to it once again, it might not work normally. If customer stops the display and function signals, they should be cut VCC.

Note3: The backlight should be turned on within the valid period of display and function signals, in order to avoid unstable data display.

PRELIMINARY

4.5 CONNECTIONS AND FUNCTIONS FOR INTERFACE PINS

CN1 socket (LCD module side): FI-XB30SL-HF10 (Japan Aviation Electronics Industry Limited (JAE))
 Adaptable plug: FI-X30* (Japan Aviation Electronics Industry Limited (JAE))

Pin No.	Symbol	Signal	Remarks
1	VCC	Power supply	Note1
2	VCC		
3	GND	Ground	Note1
4	GND		
5	D0-	Pixel data	Note2
6	D0+		
7	GND	Ground	Note1
8	D1-	Pixel data	Note2
9	D1+		
10	GND	Ground	Note1
11	D2-	Pixel data	Note2
12	D2+		
13	GND	Ground	Note1
14	CLK-	Pixel clock	Note2
15	CLK+		
16	GND	Ground	Note1
17	GND	Ground	Note1
18	DPS	Selection of scan direction	High: Reverse scan Low or Open: Normal scan Note3
19	GND	Ground	Note1
20	GND	Ground	Note1
21	K1	Cathode 1	-
22	A1	Anode 1	-
23	K2	Cathode 2	-
24	A2	Anode 2	-
25	K3	Cathode 3	-
26	A3	Anode 3	-
27	K4	Cathode 4	-
28	A4	Anode 4	-
29	K5	Cathode 5	-
30	A5	Anode 5	-

Note1: All GND and VCC terminals should be used without any non-connected lines.

Note2: Twist pair wires with 100Ω (Characteristic impedance) should be used between LCD panel signal processing board and LVDS transmitter.

Note3: See "4.11 SCANNING DIRECTIONS".

Note4: See "4.7 CONNECTION BETWEEN RECEIVER AND TRANSMITTER FOR LVDS".

PRELIMINARY

4.6 POSITION OF PLUG AND SOCKET

Side view



Rear view

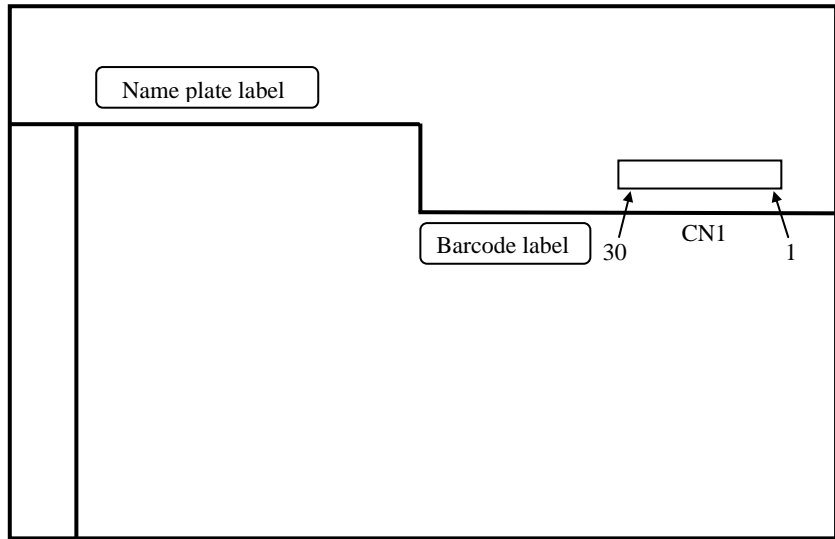

4.7 CONNECTION BETWEEN RECEIVER AND TRANSMITTER FOR LVDS

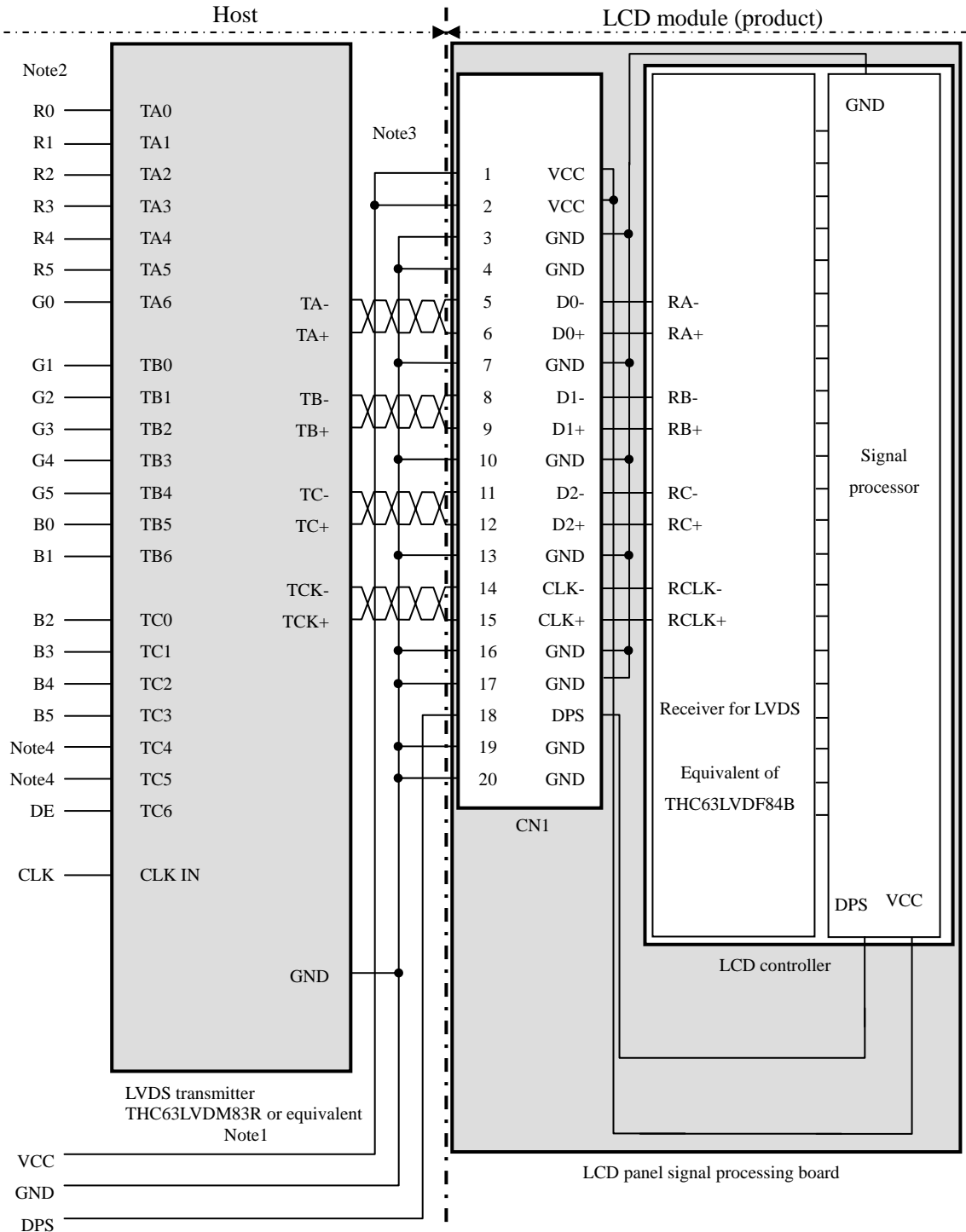

Note1: Recommended transmitter THC63LVDM83R (THine Electronics Inc.) or equivalent

Note2: LSB (Least Significant Bit) – R0, G0, B0 MSB (Most Significant Bit) – R5, G5, B5

Note3: Twist pair wires with 100Ω (Characteristic impedance) should be used between LCD panel signal processing board and LVDS transmitter.

Note4: Input signals to TC4 and TC5 are not used inside the product, but do not keep TC4 and TC5 open to avoid noise problem.

4.8 LVDS DATA INPUT MAP

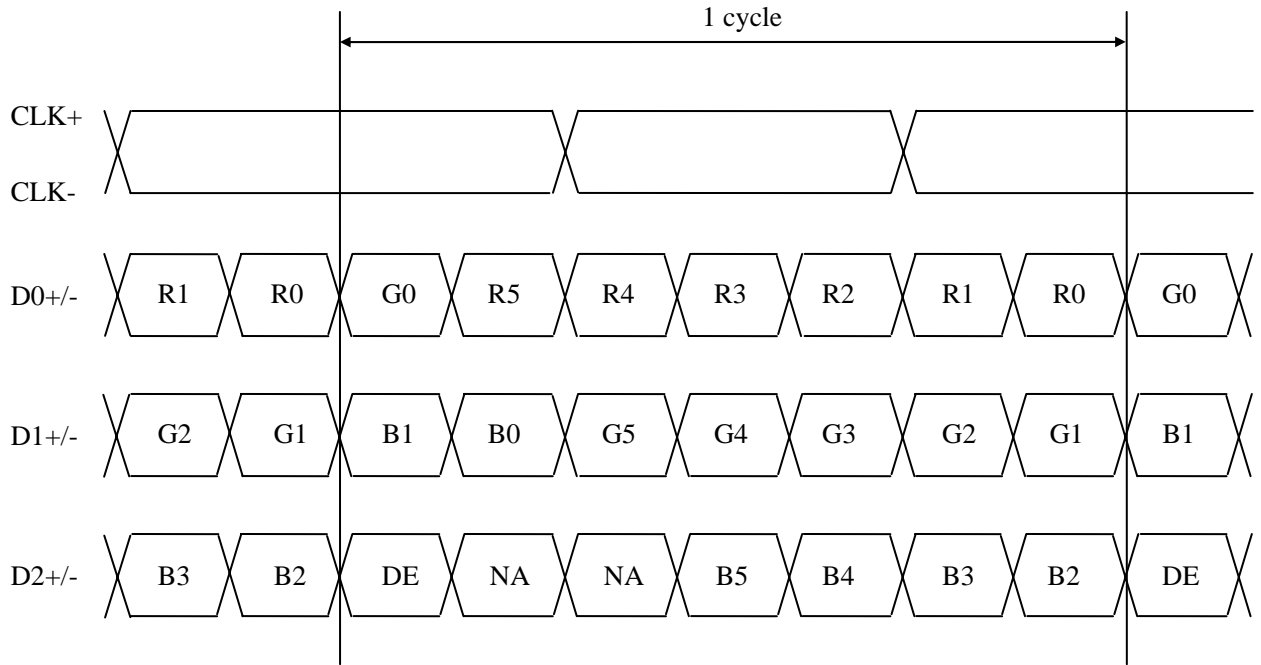

NA: Not available

PRELIMINARY

4.9 DISPLAY COLORS AND DATA SIGNALS

This product can display in equivalent to 262,144 colors in 64 gray scales. Also the relation between display colors and input data signals is as the following table.

Display colors		Data signal (0: Low level, 1: High level)																	
		R5	R4	R3	R2	R1	R0	G5	G4	G3	G2	G1	G0	B5	B4	B3	B2	B1	B0
Basic colors	Black	0	0	0	0	0	0	0	0	0	0	0	0	0	0	0	0	0	0
	Blue	0	0	0	0	0	0	0	0	0	0	0	0	1	1	1	1	1	1
	Red	1	1	1	1	1	1	0	0	0	0	0	0	0	0	0	0	0	0
	Magenta	1	1	1	1	1	1	0	0	0	0	0	0	1	1	1	1	1	1
	Green	0	0	0	0	0	0	1	1	1	1	1	1	0	0	0	0	0	0
	Cyan	0	0	0	0	0	0	1	1	1	1	1	1	1	1	1	1	1	1
	Yellow	1	1	1	1	1	1	1	1	1	1	1	1	0	0	0	0	0	0
	White	1	1	1	1	1	1	1	1	1	1	1	1	1	1	1	1	1	1
Red gray scale	Black	0	0	0	0	0	0	0	0	0	0	0	0	0	0	0	0	0	0
		0	0	0	0	0	1	0	0	0	0	0	0	0	0	0	0	0	0
	dark	0	0	0	0	1	0	0	0	0	0	0	0	0	0	0	0	0	0
	↑				:						:					:			
	↓				:						:					:			
bright	1	1	1	1	0	1	0	0	0	0	0	0	0	0	0	0	0	0	
	1	1	1	1	1	0	0	0	0	0	0	0	0	0	0	0	0	0	
Red	1	1	1	1	1	1	0	0	0	0	0	0	0	0	0	0	0	0	
Green gray scale	Black	0	0	0	0	0	0	0	0	0	0	0	0	0	0	0	0	0	0
		0	0	0	0	0	0	0	0	0	0	1	0	0	0	0	0	0	0
	dark	0	0	0	0	0	0	0	0	0	1	0	0	0	0	0	0	0	0
	↑				:					:						:			
	↓				:					:						:			
bright	0	0	0	0	0	0	1	1	1	1	0	1	0	0	0	0	0	0	
	0	0	0	0	0	0	1	1	1	1	1	0	0	0	0	0	0	0	
Green	0	0	0	0	0	0	1	1	1	1	1	1	0	0	0	0	0	0	
Blue gray scale	Black	0	0	0	0	0	0	0	0	0	0	0	0	0	0	0	0	0	0
		0	0	0	0	0	0	0	0	0	0	0	0	0	0	0	0	0	1
	dark	0	0	0	0	0	0	0	0	0	0	0	0	0	0	0	0	1	0
	↑				:					:						:			
	↓				:					:						:			
bright	0	0	0	0	0	0	0	0	0	0	0	0	1	1	1	1	0	1	
	0	0	0	0	0	0	0	0	0	0	0	0	1	1	1	1	1	0	
Blue	0	0	0	0	0	0	0	0	0	0	0	0	1	1	1	1	1	1	

4.10 DISPLAY POSITIONS

The following table is the coordinates per pixel (See "4.11 SCANNING DIRECTIONS".).

$C(0, 0)$									
<table border="1" style="display: inline-table; border-collapse: collapse;"> <tr> <td style="padding: 2px 10px;">B</td> <td style="padding: 2px 10px;">G</td> <td style="padding: 2px 10px;">R</td> </tr> </table>							B	G	R
B	G	R							
$C(0, 0)$	$C(1, 0)$...	$C(X, 0)$...	$C(1022, 0)$	$C(1023, 0)$			
$C(0, 1)$	$C(1, 1)$...	$C(X, 1)$...	$C(1022, 1)$	$C(1023, 1)$			
.			
.			
.			
$C(0, Y)$	$C(1, Y)$...	$C(X, Y)$...	$C(1022, Y)$	$C(1023, Y)$			
.			
.			
.			
$C(0, 766)$	$C(1, 766)$...	$C(X, 766)$...	$C(1022, 766)$	$C(1023, 766)$			
$C(0, 767)$	$C(1, 767)$...	$C(X, 767)$...	$C(1022, 767)$	$C(1023, 767)$			

4.11 SCANNING DIRECTIONS

The following figures are seen from a front view. Also the arrow shows the direction of scan.

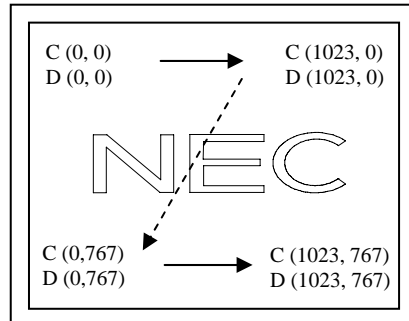

Note1

Figure 1. Normal scan (DPS: Low or Open)

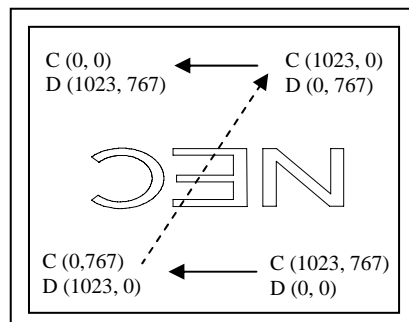

Note1

Figure 2. Reverse scan (DPS: High)

Note1: Meaning of C (X, Y) and D (X, Y)

C (X, Y): The coordinates of the display position (See "4.10 DISPLAY POSITIONS".)

D (X, Y): The data number of input signal for LCD panel signal processing board

4.12 INPUT SIGNAL TIMINGS

4.12.1 Outline of input signal timings

- Horizontal signal

Note1

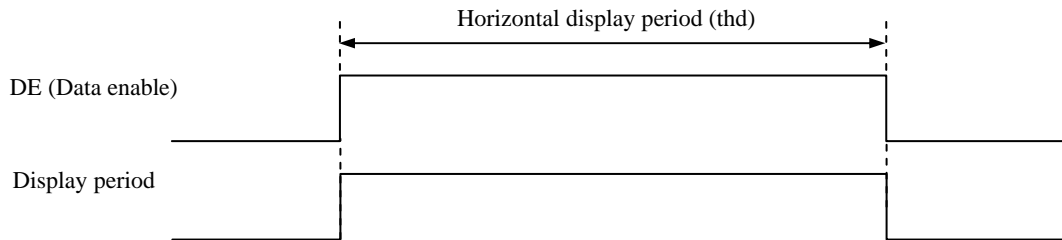

- Vertical signal

Note1

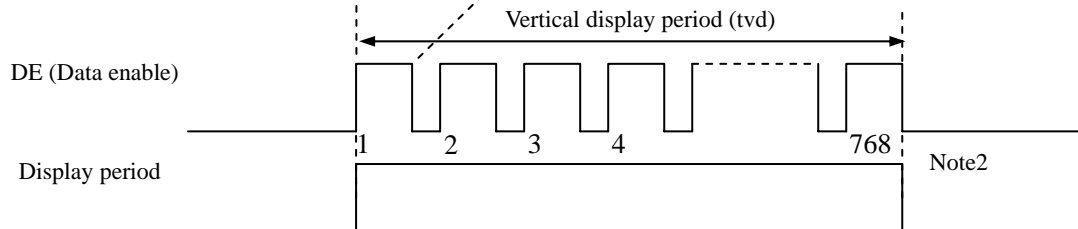

Note1: This diagram indicates virtual signal for set up to timing.

Note2: See "**4.12.3 Input signal timing chart**" for numeration of pulse.

PRELIMINARY

4.12.2 Timing characteristics

(Note1, Note2)

Parameter		Symbol	min.	typ.	max.	Unit	Remarks	
CLK	Frequency	1/tc	60.0	65.0	68.0	MHz	15.385 ns (typ.)	
	Duty	-	-			-	-	
	Rise time, Fall time	-				ns		
DATA	CLK-DATA	Setup time	-			ns	-	
		Hold time				ns		
	Rise time, Fall time	-				ns		
DE	Horizontal	Cycle	th	19.67	20.676	22.4	μs	48.363 kHz (typ.)
		Display period	thd	1,024			CLK	
	Vertical (One frame)	Cycle	tv	13.3	16.666	18.5	ms	
		Display period	tvd	768			H	
	CLK-DE	Setup time	-	-			ns	-
		Hold time	-				ns	
Rise time, Fall time	-	ns						

Note1: Definition of parameters is as follows.

$$tc = 1\text{CLK}, th = 1H$$

Note2: See the data sheet of LVDS transmitter.

4.12.3 Input signal timing chart

Horizontal timing

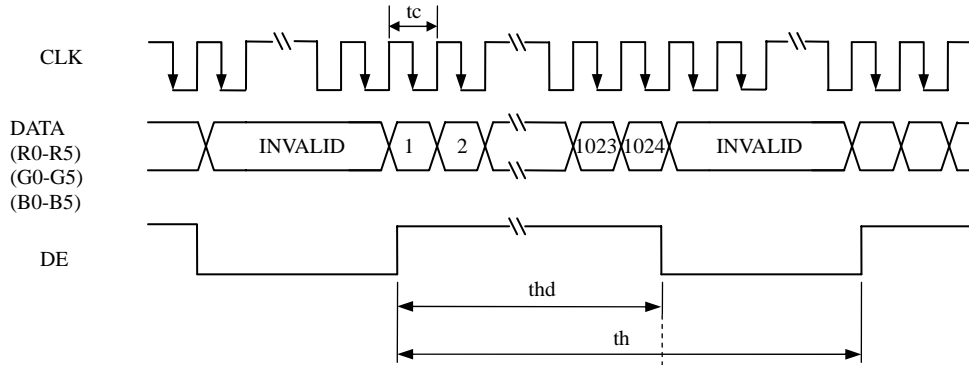

Vertical timing

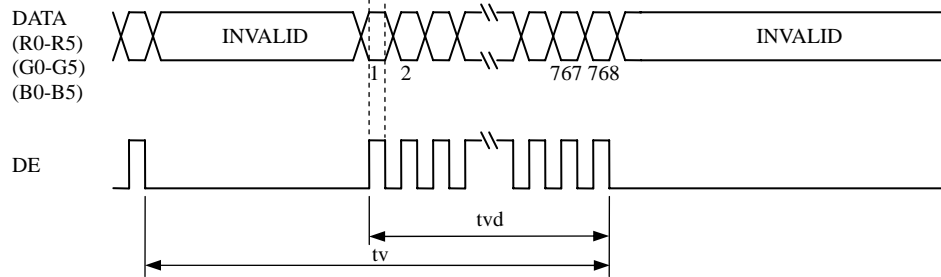

4.13 OPTICS

4.13.1 Optical characteristics

(Note1, Note2)

Parameter	Condition	Symbol	min.	typ.	max.	Unit	Measuring instrument	Remarks	
Luminance	White at center $\theta R=0^\circ, \theta L=0^\circ, \theta U=0^\circ, \theta D=0^\circ$	L	200	300	-	cd/m ²	BM-5A	-	
Contrast ratio	White/Black at center $\theta R=0^\circ, \theta L=0^\circ, \theta U=0^\circ, \theta D=0^\circ$	CR	300	600	-	-	BM-5A	Note3	
Luminance uniformity	White $\theta R=0^\circ, \theta L=0^\circ, \theta U=0^\circ, \theta D=0^\circ$	LU	-	1.25	1.40	-	BM-5A	Note4	
Chromaticity	White	x coordinate	W _x	0.263	0.313	0.363	-	SR-3	Note5
		y coordinate	W _y	0.279	0.329	0.379	-		
	Red	x coordinate	R _x	-	TBD	-	-		
		y coordinate	R _y	-	TBD	-	-		
	Green	x coordinate	G _x	-	TBD	-	-		
		y coordinate	G _y	-	TBD	-	-		
Blue	x coordinate	B _x	-	TBD	-	-			
	y coordinate	B _y	-	TBD	-	-			
Color gamut	$\theta R=0^\circ, \theta L=0^\circ, \theta U=0^\circ, \theta D=0^\circ$ at center, against NTSC color space	C	35	40	-	%			
Response time	White to Black	T _{on}	-	6	15	ms	BM-5A	Note6	
	Black to White	T _{off}	-	19	47	ms		Note7	
Viewing angle	Right	$\theta U=0^\circ, \theta D=0^\circ, CR \geq 10$	θR	35	45	-	EZ Contrast	Note8	
	Left	$\theta U=0^\circ, \theta D=0^\circ, CR \geq 10$	θL	35	45	-			
	Up	$\theta R=0^\circ, \theta L=0^\circ, CR \geq 10$	θU	10	20	-			
	Down	$\theta R=0^\circ, \theta L=0^\circ, CR \geq 10$	θD	30	40	-			

Note1: These are initial characteristics.

Note2: Measurement conditions are as follows.

T_a = 25°C, VCC = 3.3V, I_L = 20mA, Display mode: XGA, Horizontal cycle = 1/48.363kHz, Vertical cycle = 1/60.0Hz, DPS= Low or Open: Normal scan

Optical characteristics are measured at luminance saturation after 20minutes from working the product, in the dark room. Also measurement methods are as follows.

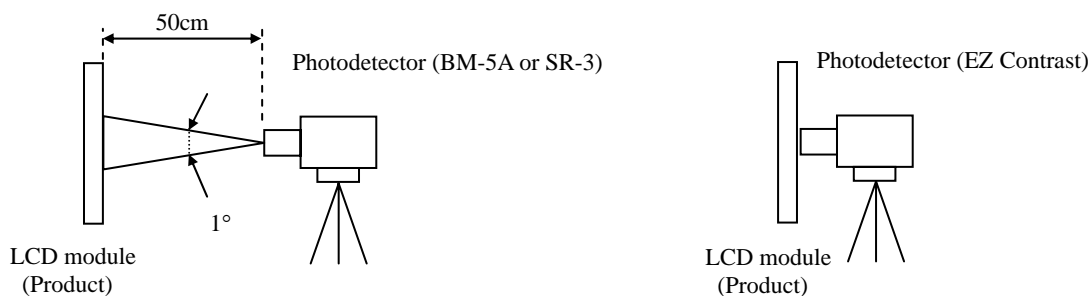

Note3: See "4.13.2 Definition of contrast ratio".

Note4: See "4.13.3 Definition of luminance uniformity".

Note5: These coordinates are found on CIE 1931 chromaticity diagram.

Note6: Product surface temperature: TopF = TBD°C

Note7: See "4.13.4 Definition of response times".

Note8: See "4.13.5 Definition of viewing angles".

4.13.2 Definition of contrast ratio

The contrast ratio is calculated by using the following formula.

$$\text{Contrast ratio (CR)} = \frac{\text{Luminance of white screen}}{\text{Luminance of black screen}}$$

4.13.3 Definition of luminance uniformity

The luminance uniformity is calculated by using following formula.

$$\text{Luminance uniformity (LU)} = \frac{\text{Maximum luminance from ① to ⑤}}{\text{Minimum luminance from ① to ⑤}}$$

The luminance is measured at near the 5 points shown below.

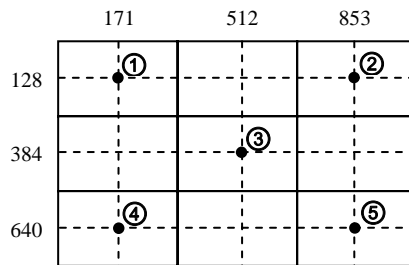

4.13.4 Definition of response times

Response time is measured, the luminance changes from "black" to "white", or "white" to "black" on the same screen point, by photo-detector. Ton is the time it takes the luminance change from 90% down to 10%. Also Toff is the time it takes the luminance change from 10% up to 90% (See the following diagram.).

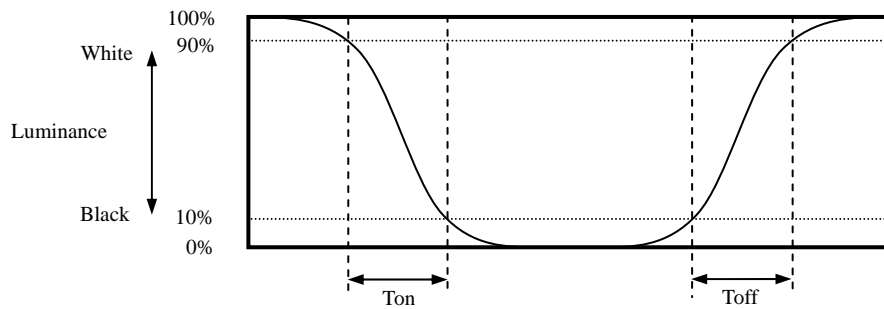

4.13.5 Definition of viewing angles

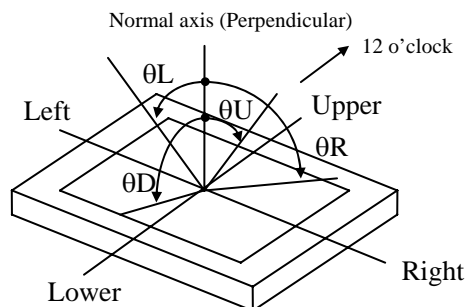

PRELIMINARY

5. RELIABILITY TESTS

(Note1)

Test item	Condition	Judgment
High temperature and humidity (Operation)	① $60 \pm 2^{\circ}\text{C}$, RH= 60%, 240hours ② Display data is black.	No display malfunctions
Heat cycle (Operation)	① $0 \pm 3^{\circ}\text{C}$...1hour $55 \pm 3^{\circ}\text{C}$...1hour ② 50cycles, 4 hours/cycle ③ Display data is black.	
Thermal shock (Non operation)	① $-20 \pm 3^{\circ}\text{C}$...30minutes $60 \pm 3^{\circ}\text{C}$...30minutes ② 100cycles, 1hour/cycle ③ Temperature transition time is within 5 minutes.	
ESD (Operation)	① 150pF, 150 Ω , $\pm 10\text{kV}$ ② 9 places on a panel surface Note2 ③ 10 times each places at 1 sec interval	
Dust (Operation)	① Sample dust: No. 15 (by JIS-Z8901)) ② 15 seconds stir ③ 8 times repeat at 1 hour interval	
Vibration (Non operation)	① 5 to 100Hz, 19.6m/s ² ② 1 minute/cycle ③ X, Y, Z direction ④ 120 times each directions	No display malfunctions No physical damages
Mechanical shock (Non operation)	① 539m/ s ² , 11ms ② $\pm X$, $\pm Y$, $\pm Z$ direction ③ 5 times each directions	

Note1: Display and appearance are checked under environmental conditions equivalent to the inspection conditions of defect criteria.

Note2: See the following figure for discharge points.

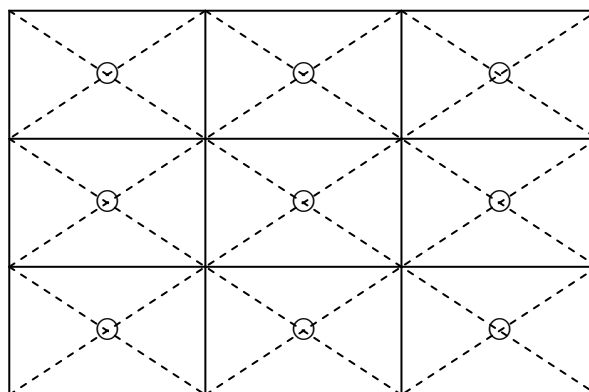

6. PRECAUTIONS

6.1 MEANING OF CAUTION SIGNS

The following caution signs have very important meaning. **Be sure to read "6.2 CAUTIONS" and "6.3 ATTENTIONS", after understanding these contents!**



This sign has the meaning that customer will be injured by himself or the product will sustain a damage, if customer has wrong operations.



This sign has the meaning that customer will be injured by himself, if customer has wrong operations.

6.2 CAUTIONS



- * **Do not touch the working backlight. There is a danger of burn injury.**
- * **Do not shock and press the LCD panel and the backlight! There is a danger of breaking, because they are made of glass. (Shock: To be not greater 539m/s^2 and to be not greater 11ms, Pressure: To be not greater 19.6 N ($\phi 16\text{mm jig}$))**

6.3 ATTENTIONS



6.3.1 Handling of the product

- ① Take hold of both ends without touching the circuit board when the product (LCD module) is picked up from inner packing box to avoid broken down or misadjustment, because of stress to mounting parts on the circuit board.
- ② Do not hook nor pull cables such as connection cable, and so on, in order to avoid any damage.
- ③ When the product is put on the table temporarily, display surface must be placed downward.
- ④ When handling the product, take the measures of electrostatic discharge with such as earth band, ionic shower and so on, because the product may be damaged by electrostatic.
- ⑤ The product must be installed without undue stress such as bends or twist. And do not add undue stress to any portion (such as bezel flat area). Bends or twist described above and undue stress to any portion may cause display mura.
- ⑥ Do not press or rub on the sensitive product surface. When cleaning the product surface, use of the cloth with ethanolic liquid such as screen cleaner for LCD is recommended.

- ⑦ Do not push nor pull the interface connectors while the product is working.
- ⑧ When handling the product, use of an original protection sheet on the product surface (polarizer) is recommended for protection of product surface. Adhesive type protection sheet may change color or characteristics of the polarizer.

6.3.2 Environment

- ① Do not operate or store in high temperature, high humidity, dewdrop atmosphere or corrosive gases. Keep the product in packing box with antistatic pouch in room temperature to avoid dusts and sunlight, when storing the product.
- ② In order to prevent dew condensation occurring by temperature difference, the product packing box should be opened after enough time being left under the environment of an unpacking room. Evaluate the leaving time sufficiently because a situation of dew condensation occurring is changed by the environmental temperature and humidity. (Recommended leaving time: 6 hours or more with packing state)
- ③ Do not operate in high magnetic field. Circuit boards may be broken down by it.
- ④ This product is not designed as radiation hardened.

6.3.3 Characteristics

The following items are neither defects nor failures.

- ① Response time, luminance and color may be changed by ambient temperature.
- ② Display mura, flicker, vertical seam or small spot may be observed depending on display patterns.
- ③ Do not display the fixed pattern for a long time because it may cause image sticking. Use a screen saver, if the fixed pattern is displayed on the screen.
- ④ The display color may be changed depending on viewing angle because of the use of condenser sheet in the backlight.
- ⑤ Optical characteristics may be changed depending on input signal timings.

6.3.4 Other

- ① All GND and VCC terminals should be used without any non-connected lines.
- ② Do not disassemble a product or adjust variable resistors.
- ③ Pack the product with original shipping package, in order to avoid any damages during transportation, when returning the product to NEC for repair and so on.

7. OUTLINE DRAWINGS

7.1 FRONT VIEW

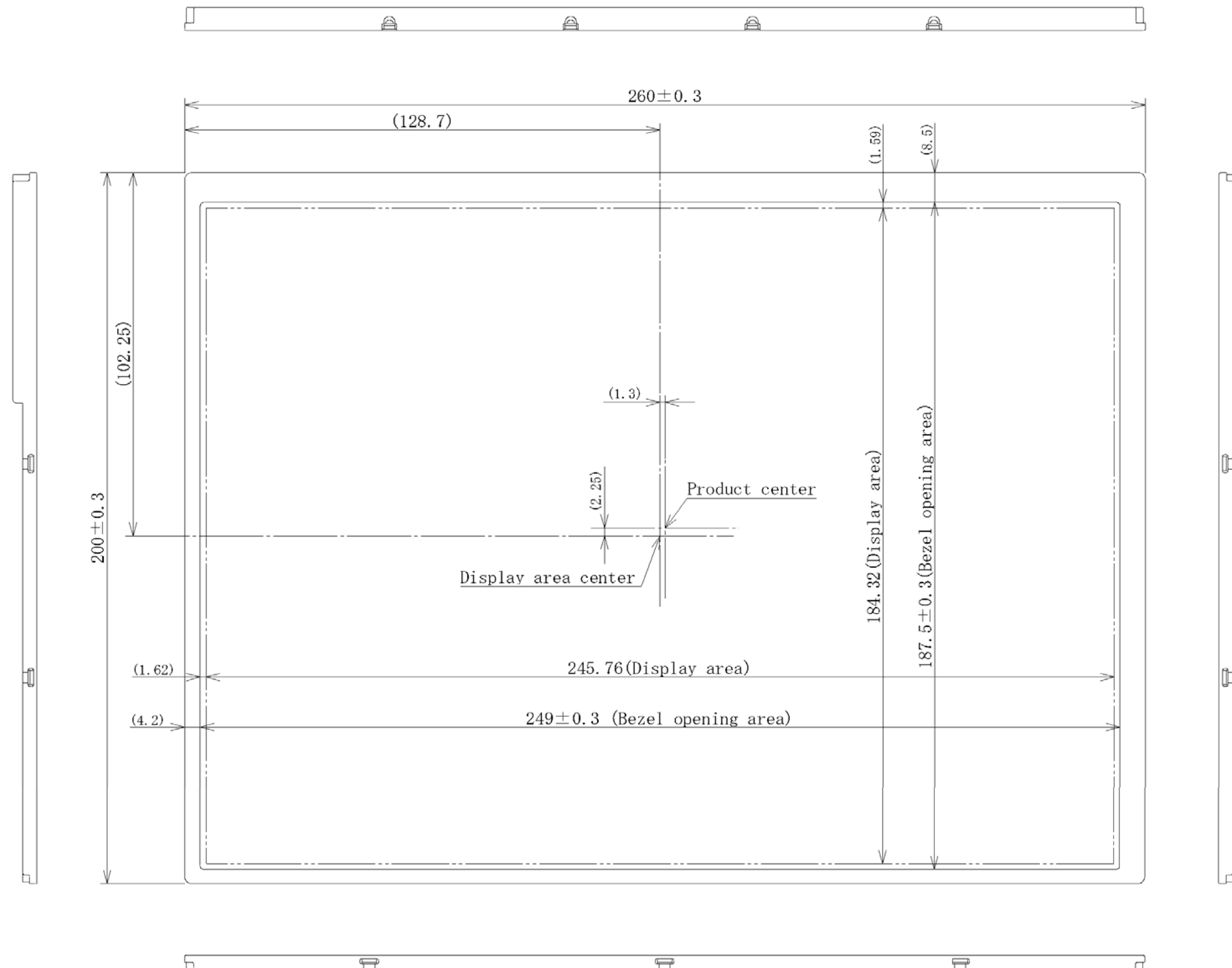

Note1: The values in parentheses are for reference.

Unit: mm

PRELIMINARY

7.2 REAR VIEW

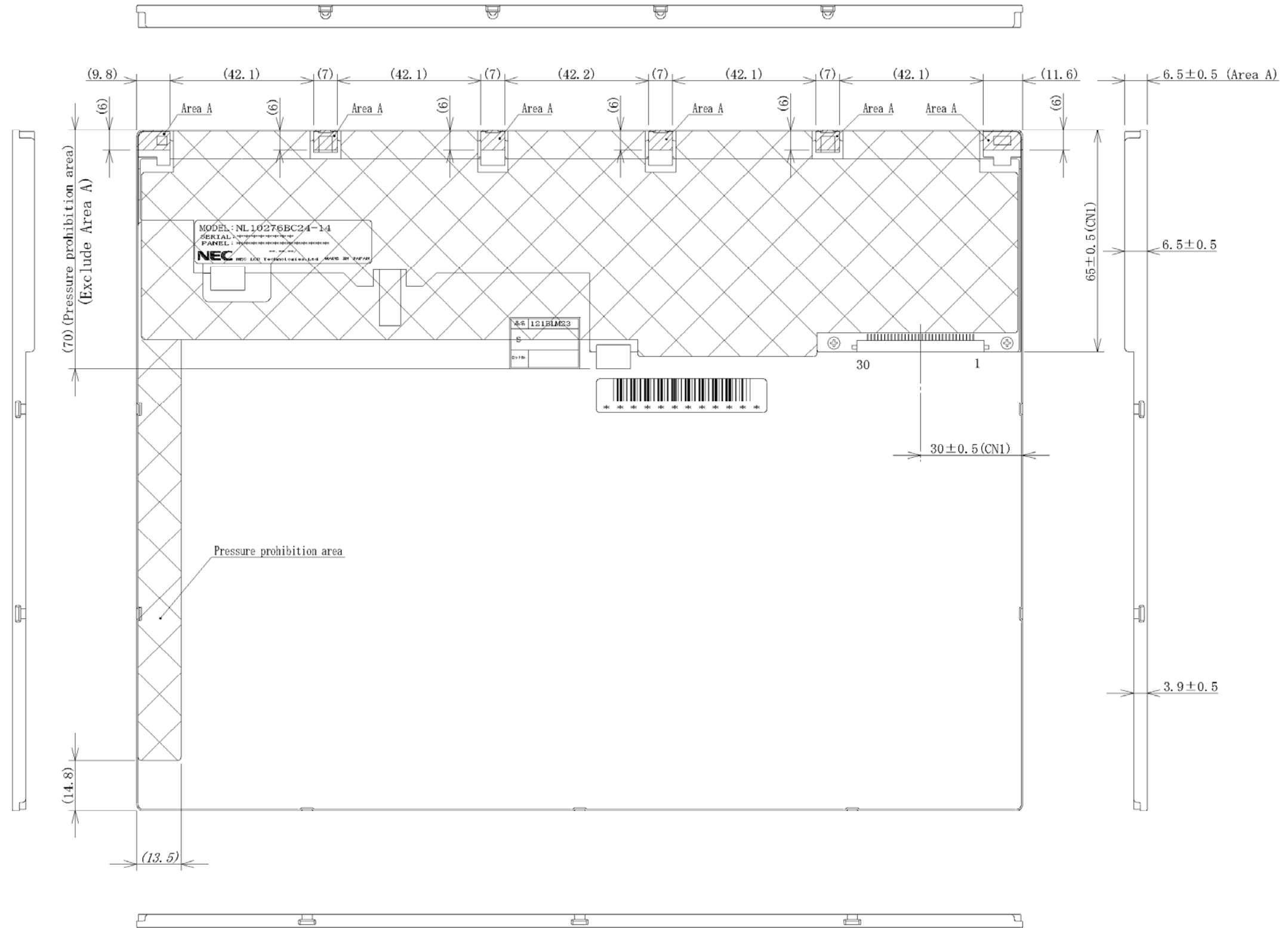







Note1: The values in parentheses are for reference.

Unit: mm

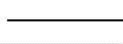
PRELIMINARY

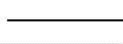
REVISION HISTORY

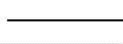
The inside of latest specifications is revised to the clerical error and the major improvement of previous edition. Only a changed part such as functions, characteristic value and so on that may affect a design of customers, are described especially below.

Edition	Document number	Prepared date	Revision contents and signature									
1st edition	DOD-PP-0048	Oct. 5, 2006	<p>Revision contents</p> <p>New issue</p> <p>Signature of writer</p> <table data-bbox="539 651 1401 768"><tr><td data-bbox="539 651 858 680"><i>Approved by</i></td><td data-bbox="863 651 1098 680"><i>Checked by</i></td><td data-bbox="1102 651 1401 680"><i>Prepared by</i></td></tr><tr><td data-bbox="539 687 858 730"></td><td data-bbox="863 687 1098 730"></td><td data-bbox="1102 687 1401 730"></td></tr><tr><td data-bbox="539 736 858 768">T. OGAWA</td><td data-bbox="863 736 1098 768"></td><td data-bbox="1102 736 1401 768">T. OGAWA</td></tr></table>	<i>Approved by</i>	<i>Checked by</i>	<i>Prepared by</i>				T. OGAWA		T. OGAWA
<i>Approved by</i>	<i>Checked by</i>	<i>Prepared by</i>										
												
T. OGAWA		T. OGAWA										