

NEC

液晶之友 电话: 020-33819057
[Http://www.lcdfriends.com](http://www.lcdfriends.com)

TFT COLOR LCD MODULE

Type: NL12876AC39-01
58 cm (23 Type), WXGA

Ultra Wide Viewing Angle (H/V 170°)

High luminance (Typ 450 cd/m²)

8 bit RGB LVDS

for Multimedia Monitor Applications

SPECIFICATIONS

(2nd Edition)

PRELIMINARY



This document is preliminary. All information in this document are subject to change without prior notice

NEC Corporation
NEC Electron Devices
Display Device Operations Unit
Color LCD Division
1st Engineering Department

Approved	T. Ito	Jul. 30,, 2001
Checked		
Prepared	A. Sawada	Jul. 30, 2001



Displays & Systems

Industriestr. 16

D-76298 Stutensee

Tel. +49 7249 910 152

Fax: +49 7249 4232

E-Mail: display@msc-ge.com

Internet: <http://www.msc-ge.com>

INTRODUCTION

No part of this document shall be copied in any form or by any means without the prior written consent of NEC Corporation.

NEC Corporation does not assume any liability for infringement of patents, copyrights or other intellectual property rights of third parties by or arising from use of a product described herein or any other liability arising from use of such application. No license, express, implied or otherwise, is granted under any patents, copyrights or other intellectual property rights of NEC Corporation or of others.

While NEC Corporation has been making continuous effort to enhance the reliability of its products, the possibility of failures cannot be eliminated entirely. To minimize risks of damage to property or injury to person arising from a failure in an NEC product, customers must incorporate sufficient safety measures in their design, such as redundancy, fire-containment and anti-failure features.

NEC products are classified into the following three quality grades:

"Standard", "Special", "Specific"

The ***"Specific"*** quality grade applies only to applications developed based on a customer designated "quality assurance program" for a specific application. The recommended applications of a product depend on its quality grade, as indicated below. Customers must check the quality grade of each application before using it in a particular application.

Standard: Computers, office equipment, communications equipment, test and measurement equipment, audio and visual equipment, home electronic appliances, machine tools, personal electronic equipment and industrial robots

Special: Transportation equipment (automobiles, trains, ships, etc.), traffic control systems, anti-disaster systems, anti-crime systems, safety equipment and medical equipment (not specifically designed for life support)

Specific: Military systems, aircraft, aerospace equipment, submersible repeaters, nuclear reactor control systems, life support systems (medical equipment, etc.) and any other equipment

The quality grade of this product is ***"Standard"*** unless otherwise specified in this document. If customers intend to use this product for applications other than those specified for ***"Standard"*** quality grade, they should contact NEC Corporation sales representative in advance.

Anti-radioactive design is not implemented in this product.

CONTENTS

INTRODUCTION	2
1. OUTLINE.....	5
1.1 STRUCTURE AND PRINCIPLE	5
1.2 APPLICATIONS	5
1.3 FEATURES	5
2. GENERAL SPECIFICATIONS	6
3. BLOCK DIAGRAM.....	7
4. DETAILED SPECIFICATIONS	8
4.1 MECHANICAL SPECIFICATIONS.....	8
4.2 ABSOLUTE MAXIMUM RATINGS	8
4.3 ELECTRICAL CHARACTERISTICS.....	9
4.3.1 Driving for LCD panel signal processing board.....	9
4.3.2 Driving for backlight inverter	9
4.3.3 Supply voltage ripple	10
4.3.4 Fuses	10
4.4 SUPPLY VOLTAGE SEQUENCE	11
4.4.1 Sequence for LCD panel signal processing board	11
4.4.2 Sequence for backlight inverter	11
4.5 CONNECTIONS AND FUNCTIONS FOR INTERFACE PINS	12
4.5.1 LCD panel signal processing board.....	12
4.5.2 Backlight inverter	13
4.5.3 Positions of sockets.....	13
4.5.4 Connection between receiver and transmitter for LVDS	14
4.6 LUMINANCE CONTROLS	15
4.6.1 Luminance control methods.....	15
4.6.2 Detail of PWM timing	16
4.7 DISPLAY COLORS AND INPUT DATA SIGNALS	17
4.8 DISPLAY POSITIONS	18
4.9 SCANNING DIRECTIONS.....	18
4.10 INPUT SIGNAL TIMINGS FOR LCD PANEL SIGNAL PROCESSING BOARD.....	19
4.10.1 Outline of input signal timings	19
4.10.2 Detailed input signal timing chart for DE mode.....	19
4.10.3 Timing characteristics	20
4.11 OPTICS.....	21
4.11.1 Optical characteristics.....	21
4.11.2 Definition of contrast ratio.....	22
4.11.3 Definition of luminance uniformity	22
4.11.4 Definition of response times	22
4.11.5 Definition of viewing angles.....	22

CONTENTS

5. RELIABILITY TESTS	23
6. PRECAUTIONS	24
6.1 MEANING OF CAUTION SIGNS	24
6.2 CAUTIONS	24
6.3 ATTENTIONS	24
6.3.1 Handling of the product	24
6.3.2 Environment	25
6.3.3 Characteristics	25
6.3.4 Other	25
7. OUTLINE DRAWINGS	26
7.1 FRONT VIEW	26
7.2 REAR VIEW	27
REVISION HISTORY	28
1st edition	28
2nd edition	28

1. OUTLINE

1.1 STRUCTURE AND PRINCIPLE

NL12876AC39-01 module is composed of the amorphous silicon thin film transistor liquid crystal display (a-Si TFT LCD) panel structure with driver LSIs for driving the TFT (Thin Film Transistor) array and a backlight unit.

The a-Si TFT LCD panel structure is injected liquid crystal material into a narrow gap between the TFT array glass substrate and a color-filter glass substrate.

Color (Red, Green, Blue) data signals from a host system (e.g. PC, signal generator, etc.) are modulated into best form for active matrix system by a signal processing board, and sent to the driver LSIs which drive the individual TFT arrays.

The TFT array as an electro-optical switch regulates the amount of transmitted light from the backlight assembly, when it is controlled by data signals. Color images are created by regulating the amount of transmitted light through the TFT array of red, green and blue dots.

1.2 APPLICATIONS

- Multimedia monitor

1.3 FEATURES

- High luminance
- Ultra wide viewing angles (Lateral electric field)
- High contrast
- High definition
- 8-bit digital RGB signals
- Single link LVDS interface
- Direct light type
- Replaceable backlight unit and inverter

2. GENERAL SPECIFICATIONS

Display area	501.1 (H) × 300.7 (V) mm (typ.)
Diagonal size of display	58.4 cm (23.0 inches)
Drive system	a-Si TFT active matrix
Display color	16,777,216 colors
Pixel	1,280 (H) × 768 (V) pixels
Pixel arrangement	RGB (Red dot, Green dot, Blue dot) vertical stripe
Dot pitch	0.1305 (H) × 0.3915 (V) mm
Pixel pitch	0.3915 (H) × 0.3915 (V) mm
Module size	528.0 (H) × 326.0 (V) × 33.0 (D) mm (typ.)
Weight	2,600 g (typ.)
Contrast ratio	TBD (typ.)
Viewing angle	<p><i>At the contrast ratio 10:1</i></p> <ul style="list-style-type: none"> • Horizontal: Left side 85° (typ.), Right side 85° (typ.) • Vertical: Up side 85° (typ.), Down side 85° (typ.)
Designed viewing direction	<ul style="list-style-type: none"> • Viewing angle with optimum grayscale ($\gamma=2.2$): normal axis
Polarizer surface	TBD
Polarizer pencil-hardness	2H (min.) [by JIS K5400]
Color gamut	<p><i>At LCD panel center</i></p> <p>60 % (typ.) [against NTSC color space]</p>
Response time	30 to 40 ms (typ.) Ton + Toff
Luminance	450 cd/m ² (typ.)
Signal system	<p>Single link LVDS (Receiver: THC63LVD824, THine Electronics Inc.)</p> <p>[8-bit digital signals for data of RGB colors, Dot clock (CLK), Data enable (DE)]</p>
Supply voltages	<p>LCD panel signal processing board: 5.0V</p> <p>Backlight inverter: 12.0V</p>
Backlight	<p>Direct light type: 12 cold cathode fluorescent lamps</p> <p>(Replaceable parts</p> <ul style="list-style-type: none"> • Backlight unit: type No. TBD • Inverter: type No. TBD <p>)</p>
Power consumption	<p><i>At maximum luminance and checkered flag pattern</i></p> <p>TBD (typ.)</p>

3. BLOCK DIAGRAM

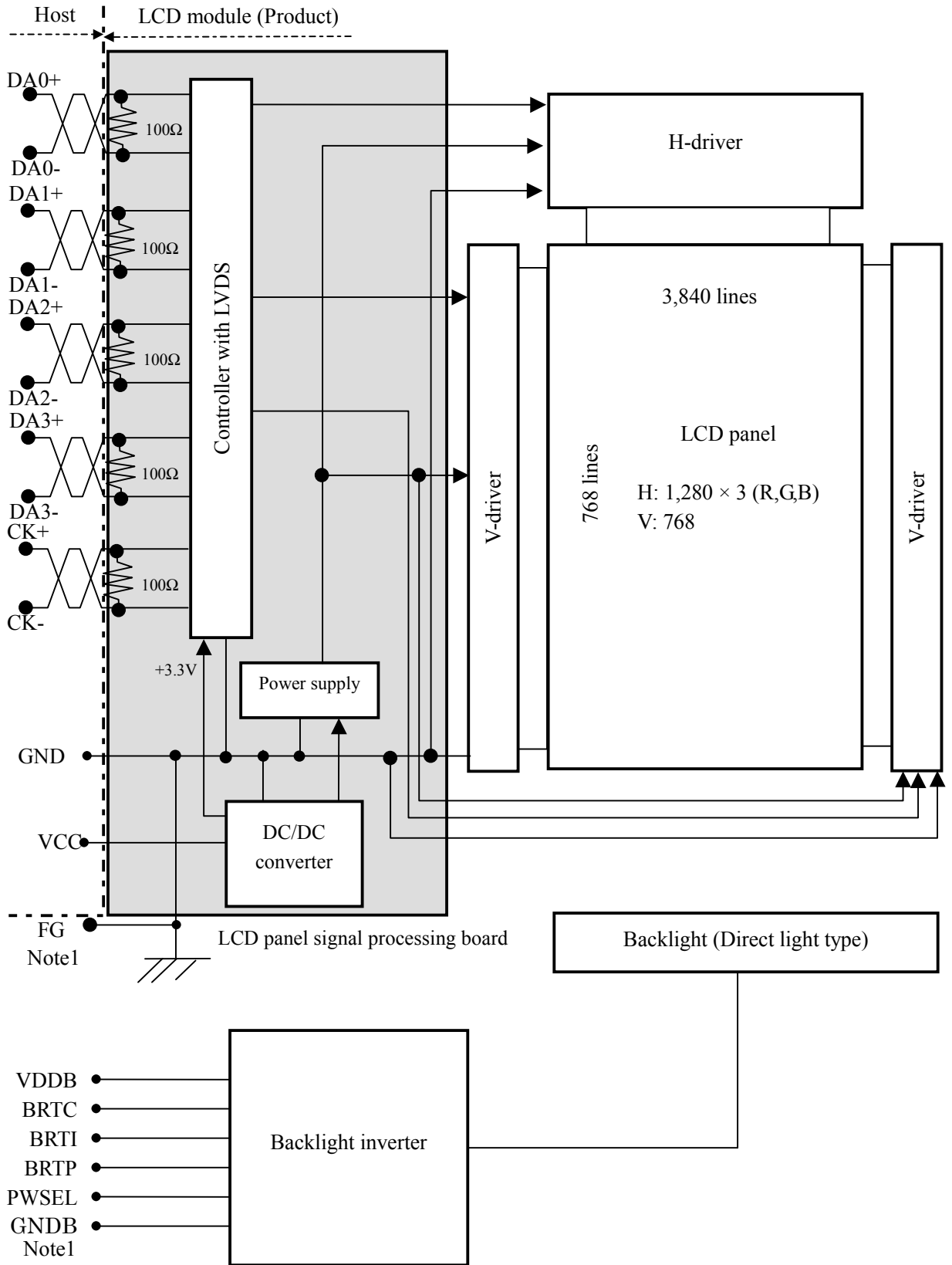

Note 1: GND is connected to FG (Frame ground). GNDB is not connected to FG.
GND and GNDB should be connected together in customer equipment.

4. DETAILED SPECIFICATIONS

4.1 MECHANICAL SPECIFICATIONS

Parameter	Specification	Unit
Module size	528.0 ± 0.5 (H) \times 326.0 ± 0.5 (V) \times 33.0 ± 0.5 (D) Note1	mm
Display area	501.1 ± 0.5 (H) \times 300.7 ± 0.5 (V) Note1	mm
Weight	2,600 (typ.), TBD (max.)	g

Note1: See "7.OUTLINE DRAWINGS".

4.2 ABSOLUTE MAXIMUM RATINGS

Parameter		Symbol	Rating	Unit	Remarks	
Supply voltage	LCD panel signal board and driver	VCC	-0.3 to +6.0	V	Ta = 25°C	
	Backlight inverter	VDDDB	-0.3 to +14	V		
Input voltage	LCD panel signal board	Display signals Note1	ViD	-0.3 to 3.4	V	
	Backlight inverter	BRTI signal	ViBI	-0.3 to +1.5	V	Ta = 25°C VDDDB = 12.0V
		B RTP signal	ViBP	-0.3 to +5.5	V	
		BRTC signal	ViBC	-0.3 to +5.5	V	
PWSEL signal	ViBS	-0.3 to +5.5	V			
Storage temperature		Tst	-20 to +60	°C	-	
Operating temperature		TopF	0 to +55	°C	Front view surface	
		TopR	0 to +66	°C	Rear view surface	
Relative humidity Note2		RH	≤ 95	%	Ta $\leq 40^\circ\text{C}$	
			≤ 85	%	$40 < \text{Ta} \leq 50^\circ\text{C}$	
			≤ 70	%	$50 < \text{Ta} \leq 55^\circ\text{C}$	
Absolute humidity Note2		-	≤ 78 Note3	g/m ³	Ta > 55°C	

Note1: Display signals are DA0+/-, DA1+/-, DA2+/-, DA3+/- and CK+/- . Also controller with LVDS receiver are worked by +3.3V from DC/DC converter.

Note2: No condensation

Note3: Ta = 55°C, RH = 70%

4.3 ELECTRICAL CHARACTERISTICS

4.3.1 Driving for LCD panel signal processing board

(Ta = 25°C)

Parameter	Symbol	Min.	Typ.	Max.	Unit	Remarks	
Supply voltage	VCC	4.8	5.0	5.2	V	-	
Supply current	ICC	-	TBD Note1	1,000 Note2	mA	VCC = 5.0V	
Input voltage for LVDS receiver	ViDR	0	-	2.4	V	-	
Differential input threshold voltage for LVDS receiver	Low	VTL	-100	-	-	mV	VOC=1.2V Note3
	High	VTH	-	-	+100	mV	

Note1: Checkered flag pattern (by EIAJ ED-2522)

Note2: Pattern for maximum current

Note3: Common mode voltage for LVDS receiver

4.3.2 Driving for backlight inverter

(Ta = 25°C)

Parameter	Symbol	Min.	Typ.	Max.	Unit	Remarks	
Supply voltage	VDDB	11.4	12.0	12.6	V	-	
Supply current	IDDB	-	TBD	TBD	mA	at maximum luminance, VDDB = 12.0V Note1	
Input voltage for control system	BRTI signal		ViBI	0	-	1.2	V
	BRTP signal	Low	ViBPL	0	-	0.8	V
		High	ViBPH	2.0	-	5.2	V
	BRTC signal	Low	ViBCL	TBD	-	TBD	V
		High	ViBCH	TBD	-	TBD	V
	PWSEL signal	Low	ViBSL	TBD	-	TBD	V
High		ViBSH	TBD	-	TBD	V	
Input current for control system	BRTI signal		IiBI	TBD	-	-	μA
	BRTP signal	Low	IiBPL	-1,580	-	-	μA
		High	IiBPH	-	-	3,500	μA
	BRTC signal	Low	IiBCL	-810	-	-	μA
		High	IiBCH	-	-	440	μA
	PWSEL signal	Low	IiBSL	-810	-	-	μA
High		IiBSH	-	-	440	μA	

Note1: The power supply lines (VDDB and GNDB) occurs large ripple voltage (See "4.3.3 Supply voltage ripple".) while dimming. There is the possibility that the ripple voltage produces acoustic noise and signal wave noise in audio circuit and so on. Put a capacitor (5,000 to 6,000μF) between the power source lines (VDDB and GNDB) to reduce the noise, if the noise occurred in the circuit.

4.3.3 Supply voltage ripple

This product works, even if the ripple voltage levels are beyond the permissible values as following the table, but there might be noise on the display image.

Supply voltage	Ripple voltage (Measure at input terminal of power supply)	Note1	Unit
VCC (for LCD panel signal processing board; 5.0V)	≤ 100		mVp-p
VDDDB (for backlight inverter; 12.0V)	≤ 200		mVp-p

Note1: The permissible ripple voltage includes spike noise.

4.3.4 Fuses

Fuse		Rating Note1	Unit	Remarks
Type	Supplier			
TBD	TBD	TBD	A	VCC (for LCD panel signal processing board)
		TBD	V	
TBD	TBD	TBD	A	VDDDB (for backlight inverter)
		TBD	V	

Note1: The power capacity should be more than twice of fuse current ratings. If the power capacity is less than the criteria value, the fuse may not blow, and then nasty smell, smoking and so on may occur.

4.4 SUPPLY VOLTAGE SEQUENCE

4.4.1 Sequence for LCD panel signal processing board

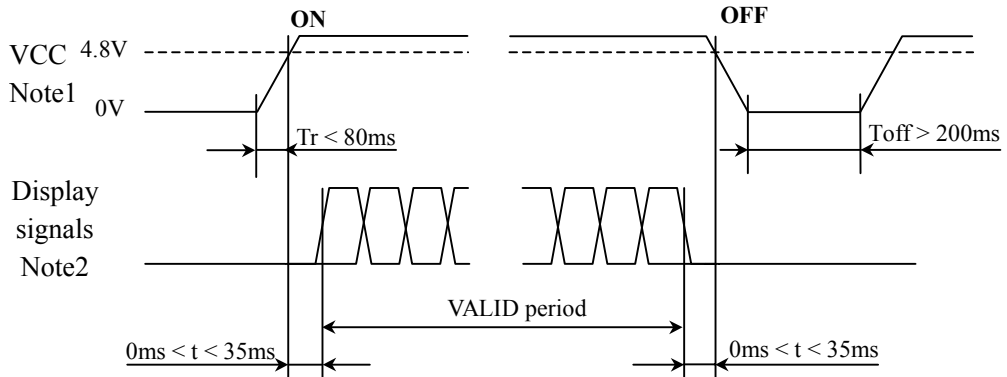

Note1: In terms of voltage variation (voltage drop) while VCC rising edge is below 4.8V, a protection circuit may work, and then this product may not work.

Note2: Display signals (DA0+/-, DA1+/-, DA2+/-, DA3+/- and CK+/-) with 100Ω (Characteristic impedance) must be Low or High-impedance, exclude the VALID period (See above sequence diagram), in order to avoid that internal circuits is damaged.

If some of display signals of this product are cut while this product is working, even if the signal input to it once again, it might not work normally. If customer stop display signals, they should be cut VCC.

4.4.2 Sequence for backlight inverter

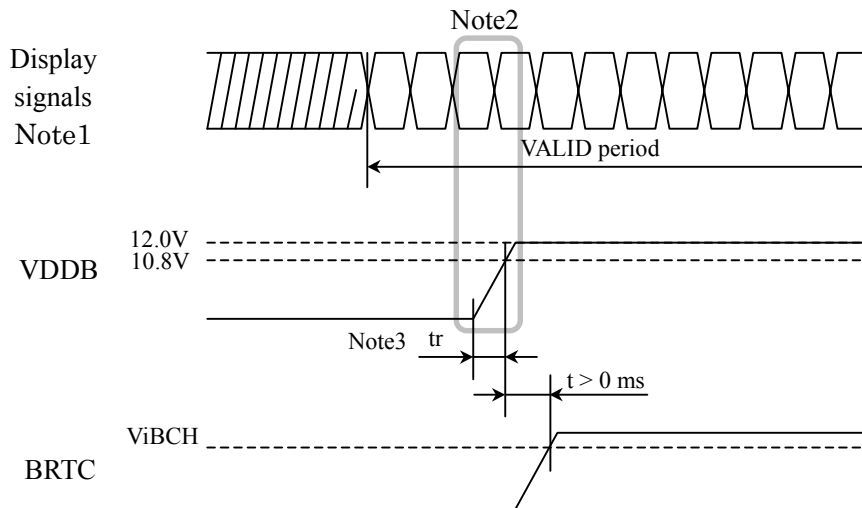

Note1: These are the display signals for LCD panel signal processing board.

Note2: The backlight power voltage (VDDb) should be inputted within the valid period of display signals, in order to avoid unstable data display.

Note3: The t_r should be less than 800ms when BRTC terminal [Socket: CN202, Pin No.: 4] (See "4.5.2 Backlight inverter".) is Open.

4.5 CONNECTIONS AND FUNCTIONS FOR INTERFACE PINS

4.5.1 LCD panel signal processing board

CN1 socket (Module side): FI-SEB20P-HF (Japan Aviation Electronics Industry Limited)

Adaptable plug: FI-SE20M (Japan Aviation Electronics Industry Limited)

Pin No.	Symbol	Function	Remarks
1	VCC	Power supply	-
2	VCC		
3	GND	Ground	-
4	GND		
5	D0-	Pixel data	Note1
6	D0+		
7	GND	Ground	-
8	D1-	Pixel data	Note1
9	D1+		
10	GND	Ground	-
11	D2-	Pixel data	Note1
12	D2+		
13	GND	Ground	-
14	CK-	Pixel clock	Note1
15	CK+		
16	GND	Ground	-
17	D3-	Pixel data	Note1
18	D3+		
19	GND	Ground	-
20	GND		

Note1: Twist pair wires with 100Ω (Characteristic impedance) should be connected between LCD panel signal processing board and LVDS transmitter.

CN1: Figure of socket

1 2 19 20

4.5.2 Backlight inverter

CN201 socket: DF3-10P-2H (Hirose Electric Co., Ltd.)

Adaptable plug: DF3-10S-2C (Hirose Electric Co., Ltd.)

Pin No.	Symbol	Function	Remarks
1	GNDB	Backlight ground	-
2	GNDB	Backlight ground	
3	GNDB	Backlight ground	
4	GNDB	Backlight ground	
5	GNDB	Backlight ground	
6	VDDDB	Power supply	
7	VDDDB	Power supply	
8	VDDDB	Power supply	
9	VDDDB	Power supply	
10	VDDDB	Power supply	

CN201: Figure of socket

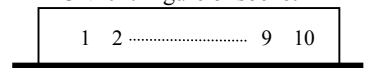

CN202 socket: IL-Z-9PL1-SMTY (Japan Aviation Electronics Industry Limited)

Adaptable plug: IL-Z-9S-S125C3 (Japan Aviation Electronics Industry Limited)

Pin No.	Symbol	Function	Remarks
1	GNDB	Backlight ground	-
2	N.C.	Non-connection	
3	N.C.	Non-connection	
4	BRTC	Backlight ON/OFF signal	ON: High or Open, OFF: Low
5	GNDB	Backlight ground	-
6	BRTI	Luminance control by resistor method or voltage method	Note1
7	B RTP	PWM signal	
8	GNDB	Backlight ground	-
9	PWSEL	Select of luminance control signal method	Note1

Note1: See "4.6.1 Luminance control methods".

CN202: Figure of socket

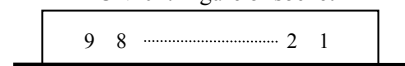

4.5.3 Positions of sockets

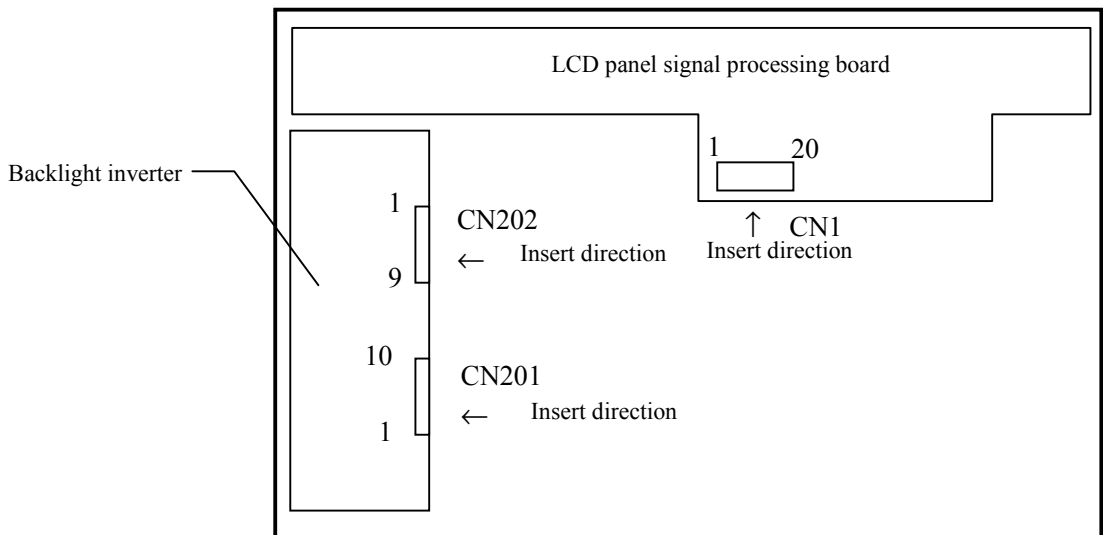

4.5.4 Connection between receiver and transmitter for LVDS

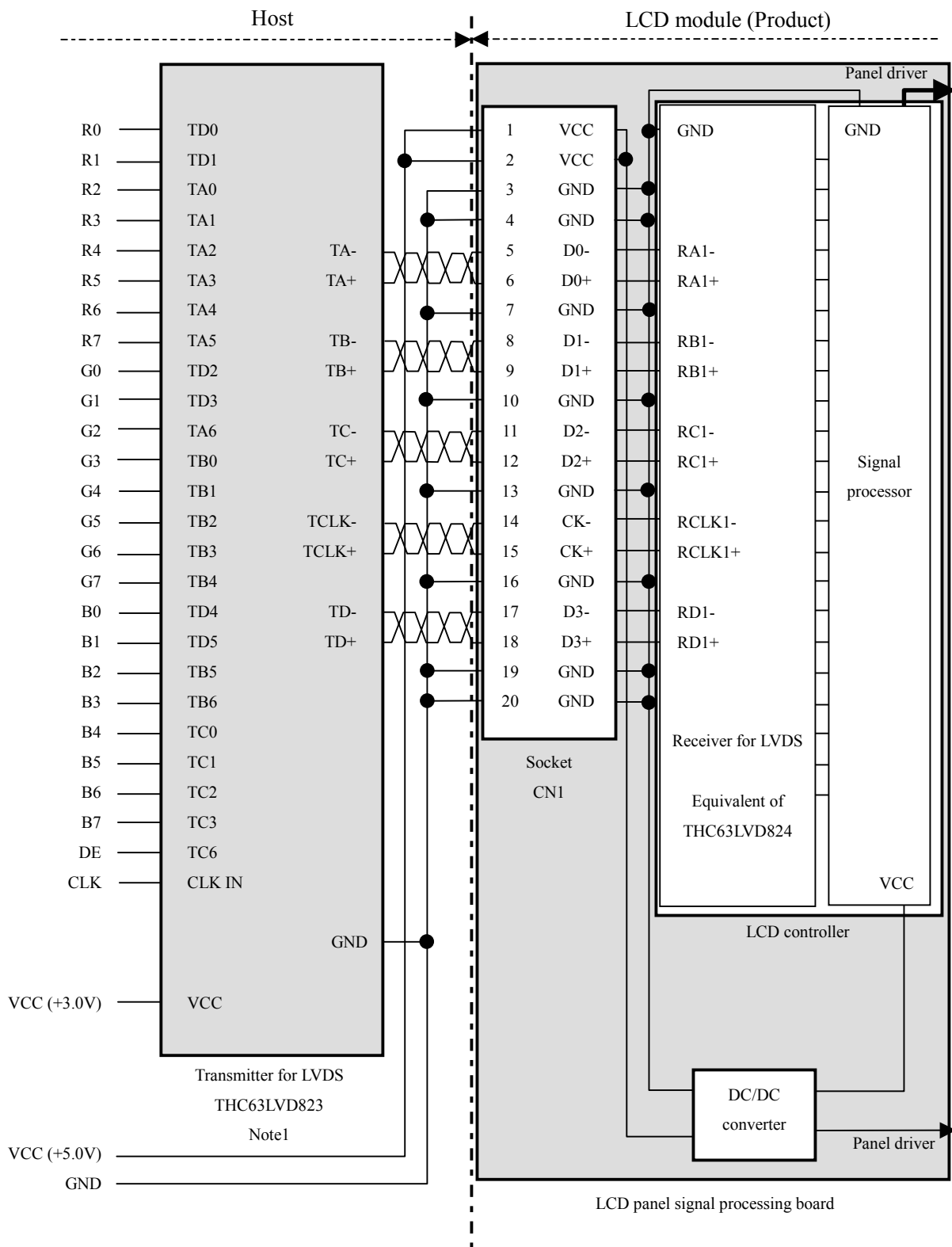

Note1: Recommended transmitter
See the data sheet for THC63LVD823 (Thein Electronics Inc.).

4.6 LUMINANCE CONTROLS

4.6.1 Luminance control methods

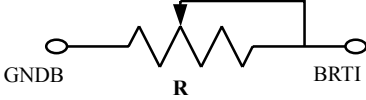
Method	Adjustment and luminance ratio	PWSEL signal	BRTP signal						
Resistor control Note1	<ul style="list-style-type: none"> • Adjustment The variable resistor (R) for luminance control should be $10\text{k}\Omega \pm 5\%$, B curve, 1/10W. Minimum point of the resistor is the minimum luminance. Also maximum point of the resistor is the maximum luminance.  <ul style="list-style-type: none"> • Luminance ratio Note3 <table border="1"> <thead> <tr> <th>Resistance</th> <th>Luminance ratio</th> </tr> </thead> <tbody> <tr> <td>0 kΩ</td> <td>20% (Minimum)</td> </tr> <tr> <td>10 kΩ</td> <td>100% (Maximum)</td> </tr> </tbody> </table>	Resistance	Luminance ratio	0 k Ω	20% (Minimum)	10 k Ω	100% (Maximum)	High or Open	Open
Resistance	Luminance ratio								
0 k Ω	20% (Minimum)								
10 k Ω	100% (Maximum)								
Voltage control Note1	<ul style="list-style-type: none"> • Adjustment This control method can carry out continuation adjustment of luminance, if it is adjusted within the rated voltage for BRTI signal (V_{iBI}). <ul style="list-style-type: none"> • Luminance ratio Note3 <table border="1"> <thead> <tr> <th>BRTI Voltage (V_{iBI})</th> <th>Luminance ratio</th> </tr> </thead> <tbody> <tr> <td>0V</td> <td>20% (Minimum)</td> </tr> <tr> <td>1.0V</td> <td>100% (Maximum)</td> </tr> </tbody> </table>	BRTI Voltage (V_{iBI})	Luminance ratio	0V	20% (Minimum)	1.0V	100% (Maximum)		
BRTI Voltage (V_{iBI})	Luminance ratio								
0V	20% (Minimum)								
1.0V	100% (Maximum)								
Pulse width modulation Note1 Note2	<ul style="list-style-type: none"> • Adjustment Pulse width modulation (PWM) method works, when PWSEL signal is Low and PWM signal (BRTP signal) is inputted into BRTP terminal. The luminance is controlled by duty ratio of BRTP signal. <ul style="list-style-type: none"> • Luminance ratio Note3 <table border="1"> <thead> <tr> <th>Duty ratio Note4</th> <th>Luminance ratio</th> </tr> </thead> <tbody> <tr> <td>0.2</td> <td>20% (Minimum)</td> </tr> <tr> <td>1.0</td> <td>100% (Maximum)</td> </tr> </tbody> </table>	Duty ratio Note4	Luminance ratio	0.2	20% (Minimum)	1.0	100% (Maximum)	Low	PWM signal
Duty ratio Note4	Luminance ratio								
0.2	20% (Minimum)								
1.0	100% (Maximum)								

Note1: In case of the resistor control method and the voltage control method, noises may appear on the display image depending on the input signals timing for LCD panel signal processing board.

Use PWM method, if interference noises appear on the display image!

Note2: In case BRTC signal is High or Open, the inverter will stop work when BRTP signal is fixed to Low. In this case, backlight will not turn on, even if BRTP signal is inputted again. This is not out of order. Backlight inverter will start to work when power is supplied again.

Note3: These data are the target values.

Note4: See "4.6.2 Detail of PWM timing".

4.6.2 Detail of PWM timing

(1) Timing diagrams

• Outline chart

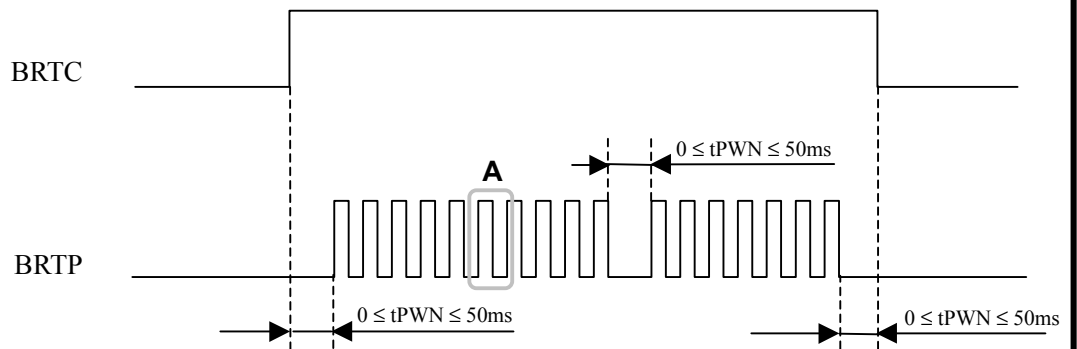

• Detail of A part

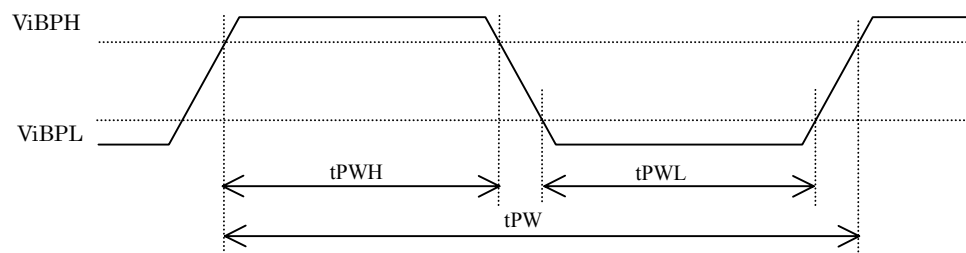

(2) Each parameter

Parameter	Symbol	Min.	Typ.	Max.	Unit	Remarks
Luminance control frequency	$1/t_{PW}$	185	255	325	Hz	Note1
Duty ratio	t_{PWH}/t_{PW}	0.2	-	1.0	-	Note2
Non signal period	t_{PWN}	0	-	50	ms	Note3

Note1: See the following formula for luminance control frequency.

$$\text{Luminance control frequency} = t_v \times (n+0.25) \text{ [or } (n + 0.75)]$$

$$n = 1, 2, 3 \dots \dots$$

t_v : See "4.10.4 Timing characteristics".

The interference noise of luminance control frequency and input signal frequency for LCD panel signal processing board may appear on a display. Set up luminance control frequency so that the interference noise does not appear!

Note2: See "4.6.1 Luminance control methods".

Note3: If t_{PWN} is more than 50ms, the backlight will be turned off by a protection circuit for inverter.

4.7 DISPLAY COLORS AND INPUT DATA SIGNALS

This product can display in equivalent to 16,777,216 colors in 256 scale. Also the relation between display colors and input data signals is as the following table.

Display colors		Data signal (0: Low level, 1: High level)																							
		R7	R6	R5	R4	R3	R2	R1	R0	G7	G6	G5	G4	G3	G2	G1	G0	B7	B6	B5	B4	B3	B2	B1	B0
Basic colors	Black	0	0	0	0	0	0	0	0	0	0	0	0	0	0	0	0	0	0	0	0	0	0	0	0
	Blue	0	0	0	0	0	0	0	0	0	0	0	0	0	0	0	0	1	1	1	1	1	1	1	1
	Red	1	1	1	1	1	1	1	1	0	0	0	0	0	0	0	0	0	0	0	0	0	0	0	0
	Magenta	1	1	1	1	1	1	1	1	0	0	0	0	0	0	0	0	1	1	1	1	1	1	1	1
	Green	0	0	0	0	0	0	0	0	1	1	1	1	1	1	1	1	0	0	0	0	0	0	0	0
	Cyan	0	0	0	0	0	0	0	0	1	1	1	1	1	1	1	1	1	1	1	1	1	1	1	1
	Yellow	1	1	1	1	1	1	1	1	1	1	1	1	1	1	1	1	0	0	0	0	0	0	0	0
	White	1	1	1	1	1	1	1	1	1	1	1	1	1	1	1	1	1	1	1	1	1	1	1	1
Red scale	Black	0	0	0	0	0	0	0	0	0	0	0	0	0	0	0	0	0	0	0	0	0	0	0	0
		0	0	0	0	0	0	0	1	0	0	0	0	0	0	0	0	0	0	0	0	0	0	0	0
	dark	0	0	0	0	0	0	1	0	0	0	0	0	0	0	0	0	0	0	0	0	0	0	0	0
	↑					:																			
	↓					:																			
	bright	1	1	1	1	1	1	0	1	0	0	0	0	0	0	0	0	0	0	0	0	0	0	0	0
Red	1	1	1	1	1	1	1	0	0	0	0	0	0	0	0	0	0	0	0	0	0	0	0	0	
Red	1	1	1	1	1	1	1	1	0	0	0	0	0	0	0	0	0	0	0	0	0	0	0	0	
Green scale	Black	0	0	0	0	0	0	0	0	0	0	0	0	0	0	0	0	0	0	0	0	0	0	0	0
		0	0	0	0	0	0	0	0	0	0	0	0	0	0	0	1	0	0	0	0	0	0	0	0
	dark	0	0	0	0	0	0	0	0	0	0	0	0	0	0	1	0	0	0	0	0	0	0	0	0
	↑					:																			
	↓					:																			
	bright	0	0	0	0	0	0	0	0	1	1	1	1	1	1	0	1	0	0	0	0	0	0	0	0
Green	0	0	0	0	0	0	0	0	1	1	1	1	1	1	1	0	0	0	0	0	0	0	0	0	
Green	0	0	0	0	0	0	0	0	1	1	1	1	1	1	1	1	0	0	0	0	0	0	0	0	
Blue scale	Black	0	0	0	0	0	0	0	0	0	0	0	0	0	0	0	0	0	0	0	0	0	0	0	0
		0	0	0	0	0	0	0	0	0	0	0	0	0	0	0	0	0	0	0	0	0	0	0	1
	dark	0	0	0	0	0	0	0	0	0	0	0	0	0	0	0	0	0	0	0	0	0	0	1	0
	↑					:																			
	↓					:																			
	bright	0	0	0	0	0	0	0	0	0	0	0	0	0	0	0	0	1	1	1	1	1	1	0	1
Blue	0	0	0	0	0	0	0	0	0	0	0	0	0	0	0	0	1	1	1	1	1	1	1	0	
Blue	0	0	0	0	0	0	0	0	0	0	0	0	0	0	0	0	1	1	1	1	1	1	1	1	

4.8 DISPLAY POSITIONS

The following table is the coordinates per pixel (See figure of "4.9 SCANNING DIRECTIONS").

C(0, 0)	C(1, 0)	...	C(X, 0)	...	C(1278, 0)	C(1279, 0)
C(0, 1)	C(1, 1)	...	C(X, 1)	...	C(1278, 1)	C(1279, 1)
⋮	⋮	⋮	⋮	⋮	⋮	⋮
C(0, Y)	C(1, Y)	...	C(X, Y)	...	C(1278, Y)	C(1279, Y)
⋮	⋮	⋮	⋮	⋮	⋮	⋮
C(0,766)	C(0,766)	...	C(X,766)	...	C(1278,766)	C(1279,766)
C(0,767)	C(1,767)	...	C(X,767)	...	C(1278,767)	C(1279,767)

4.9 SCANNING DIRECTIONS

The following figures are seen from a front view. Also the arrow shows the direction of scan.

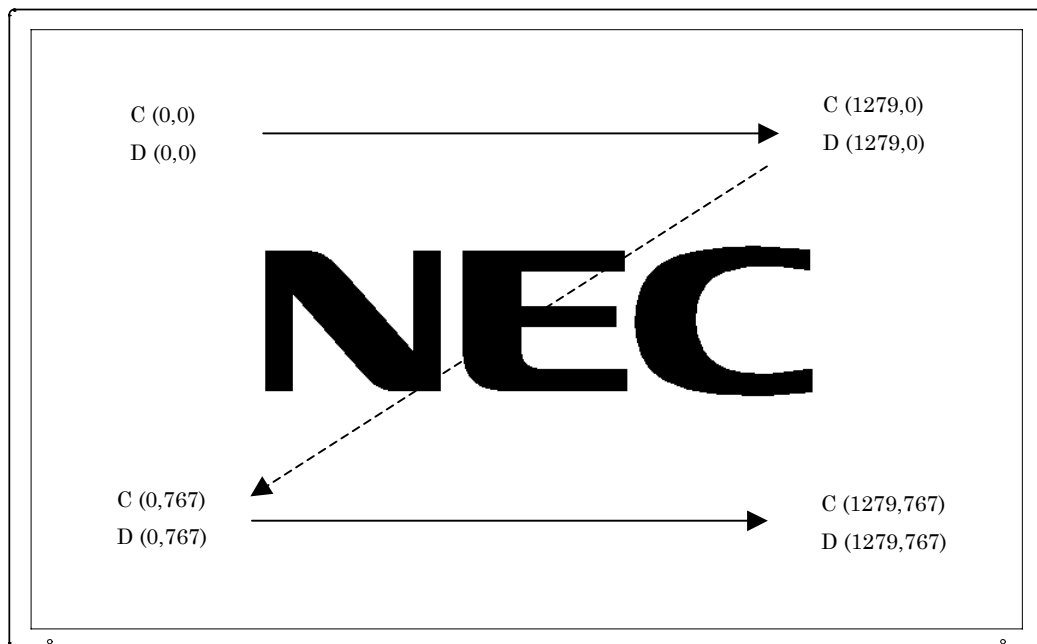

Note1: Meaning of C (X, Y) and D (X, Y)

C (X, Y): The coordinates of the display position (See "4.8 DISPLAY POSITIONS".)

D (X, Y): The data number of input signal for LCD panel signal processing board

4.10 INPUT SIGNAL TIMINGS FOR LCD PANEL SIGNAL PROCESSING BOARD

4.10.1 Outline of input signal timings

- Horizontal signal

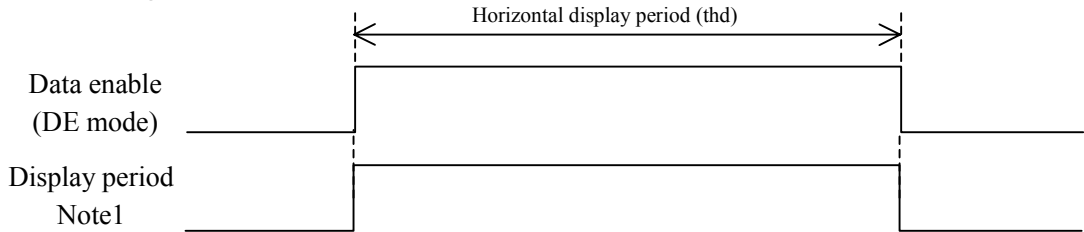

Note1: This diagram indicates virtual signal for set up to timing.

- Vertical signal

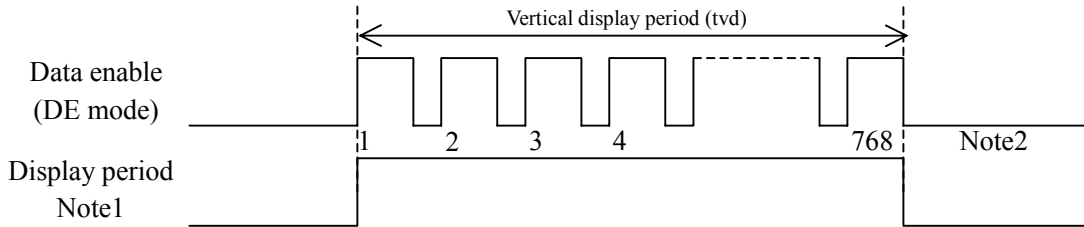

Note1: This diagram indicates virtual signal for set up to timing.

Note2: See "4.10.2 Detailed input signal timing chart for DE mode" for numeration of pulse.

4.10.2 Detailed input signal timing chart for DE mode

- Outline chart

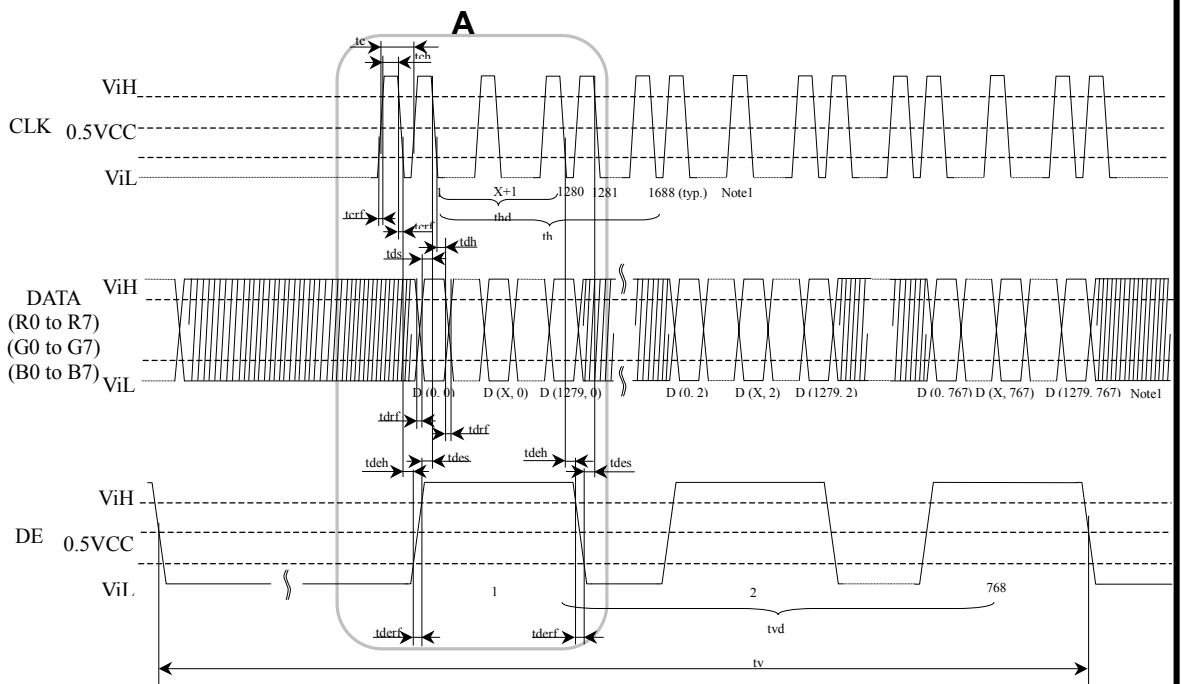

Note1: X is data number from 1 to 1278. See "4.9 SCANNING DIRECTIONS".

• Detail of **A** part

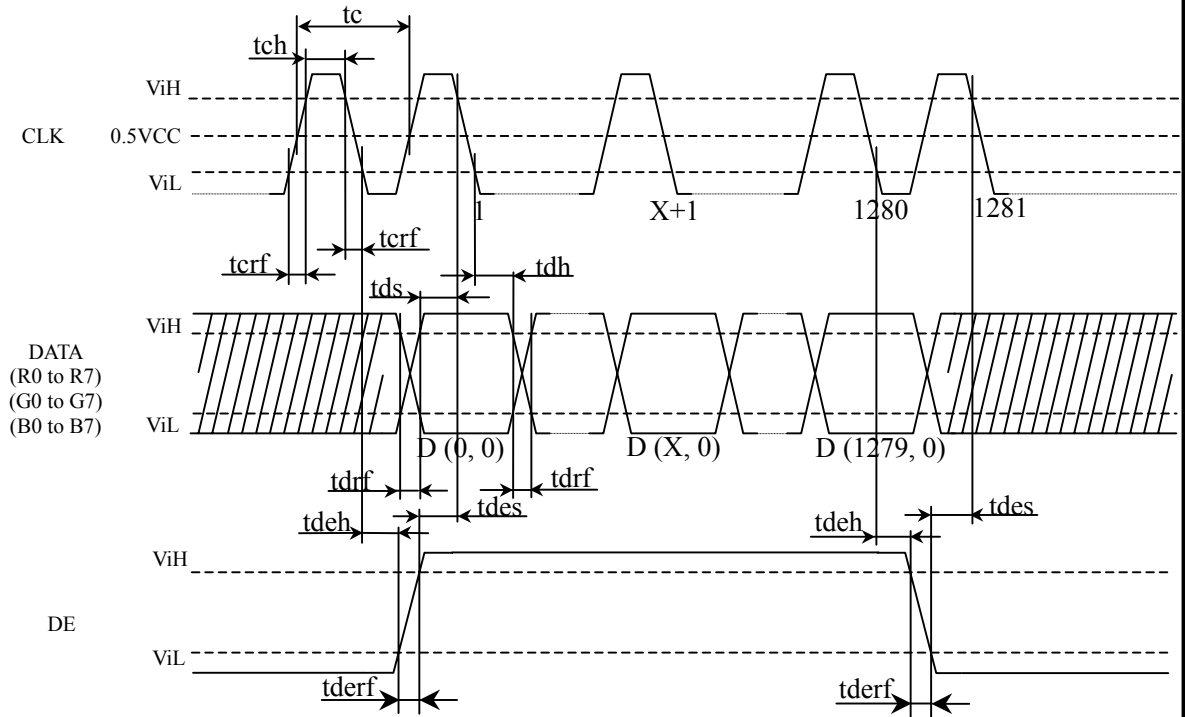

Note1: X is data number from 1 to 1278. See "4.9 SCANNING DIRECTIONS".

4.10.3 Timing characteristics

Parameter	Note1	Symbol	Min.	Typ.	Max.	Unit	Remarks	
CLK	Frequency (LVDS receiver)	$1/t_c$	78.0	81.0	84.0	MHz	12.3 ns (typ.)	
	Duty	t_{ch}/t_c	-	-	-	-	Note1	
	Rise time, Fall time	t_{crf}	-	-	-	-		
DATA	CLK-DATA	Setup time	t_{ds}	-	-	-	Note1	
		Hold time	t_{dh}	-	-	-		
	Rise time, Fall time	t_{drf}	-	-	-	-		
DE	Horizontal	Cycle	t_h	-	1,688	-	CLK	Note2, Note3
		Display period	t_{hd}	1,280			CLK	Note3
	Vertical (One frame)	Cycle	t_v	-	806	-	H	
		Display period	t_{vd}	768			H	
	CLK-DE	Setup time	t_{des}	-	-	-	-	Note1
		Hold time	t_{deh}	-	-	-	-	
	Rise time, Fall time	t_{derf}	-	-	-	-		

Note1: See the data sheet of LVDS transmitter.

Note2: "th" must keep the fluctuation within ± 1 CLK, because of avoidance of image sticking.

Note3: Definition of units is as follows.

$$t_c = 1\text{CLK}, t_h = 1\text{H}$$

4.11 OPTICS

4.11.1 Optical characteristics

Parameter	Note1	Symbol	Condition	Min.	Typ.	Max.	Unit	Remarks	
Contrast ratio		CR	White/Black at center $\theta_R = 0^\circ, \theta_L = 0^\circ, \theta_U = 0^\circ, \theta_D = 0^\circ$	200	TBD	-	-	Note2	
Luminance		L	White at center $\theta_R = 0^\circ, \theta_L = 0^\circ, \theta_U = 0^\circ, \theta_D = 0^\circ$	TBD	450	-	cd/m ²	-	
Luminance uniformity		LU	-	-	TBD	1.30	-	Note3	
Chromaticity		W	White (x, y)	-	0.300, 0.315	-	-	-	
		R	Red (x, y)	-	TBD, TBD	-	-		
		G	Green (x, y)	-	TBD, TBD	-	-		
		B	Blue (x, y)	-	TBD, TBD	-	-		
Color gamut		C	$\theta_R = 0^\circ, \theta_L = 0^\circ, \theta_U = 0^\circ, \theta_D = 0^\circ$ at center, against NTSC color space	50	60	-	%		
Response time Note4		Ton	Black to White	-	TBD	TBD	ms	Note5	
		Toff	White to Black	-	TBD	TBD	ms		
Viewing angle	CR = 10	Right	θ_R	$\theta_U = 0^\circ, \theta_D = 0^\circ$	-	85	-	$^\circ$	Note6
		Left	θ_L	$\theta_U = 0^\circ, \theta_D = 0^\circ$	-	85	-	$^\circ$	
		Up	θ_U	$\theta_R = 0^\circ, \theta_L = 0^\circ$	-	85	-	$^\circ$	
		Down	θ_D	$\theta_R = 0^\circ, \theta_L = 0^\circ$	-	85	-	$^\circ$	

Note1: Measurement conditions are as follows.

$T_a = 25^\circ\text{C}$, $V_{CC} = 3.3\text{V}$, $V_{DDB} = 12.0\text{V}$

Optical characteristics are measured at luminance saturation after 20minutes from working the product, in the dark room. Also measurement method for luminance is as follows.

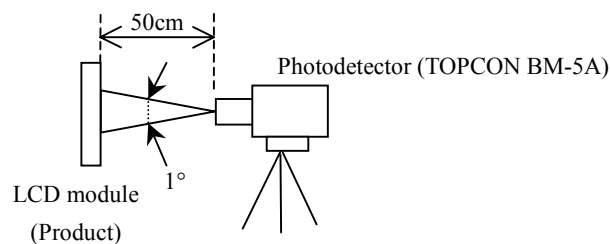

Note2: See "4.11.2 Definition of contrast ratio".

Note3: See "4.11.3 Definition of luminance uniformity".

Note4: Product surface temperature: $T_{opF} = 25^\circ\text{C}$

Note5: See "4.11.4 Definition of response times".

Note6: See "4.11.5 Definition of viewing angles".

4.11.2 Definition of contrast ratio

The contrast ratio is calculated by using the following formula.

$$\text{Contrast ratio (CR)} = \frac{\text{Luminance of white screen}}{\text{Luminance of black screen}}$$

4.11.3 Definition of luminance uniformity

The luminance uniformity is calculated by using following formula.

$$\text{Luminance uniformity (LU)} = \frac{\text{Maximum luminance from ① to ⑤}}{\text{Minimum luminance from ① to ⑤}}$$

The luminance is measured at near the 5 points shown below.

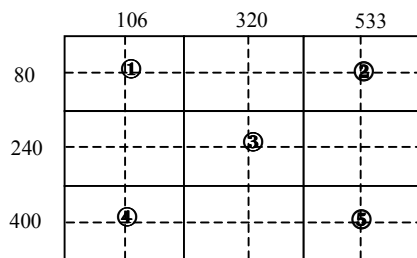

4.11.4 Definition of response times

Response time is measured, the luminance changes from "black" to "white", or "white" to "black" on the same screen point, by photo-detector. Ton is the time it takes the luminance change from 10% up to 90%. Also Toff is the time it takes the luminance change from 90% down to 10% (See the following diagram.).

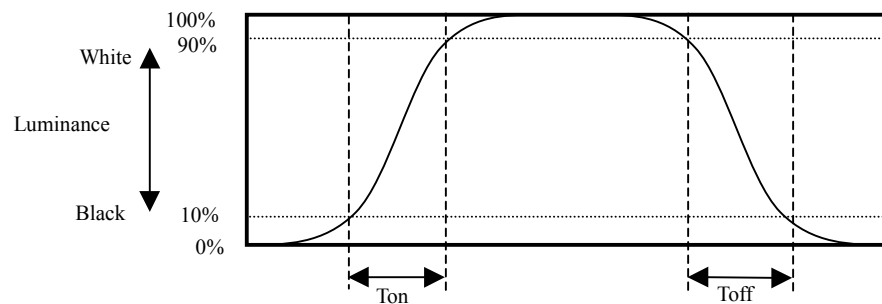

4.11.5 Definition of viewing angles

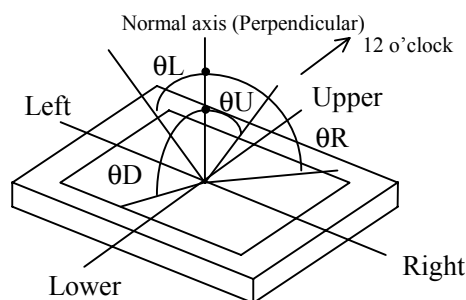

5. RELIABILITY TESTS

Test item	Condition	Judgment
High temperature and humidity (Operation)	① $60 \pm 2^{\circ}\text{C}$, RH = 60%, 240hours ② Display data is black.	No display malfunctions Note1
Heat cycle (Operation)	① $0 \pm 3^{\circ}\text{C}$...1hour $55 \pm 3^{\circ}\text{C}$...1hour ② 50cycles, 4hours/cycle ③ Display data is black.	No display malfunctions Note1
Thermal shock (Non operation)	① $-20 \pm 3^{\circ}\text{C}$...30minutes $60 \pm 3^{\circ}\text{C}$...30minutes ② 100cycles, 30minutes/cycle ③ Temperature transition time is within 5 minutes.	No display malfunctions Note1
Vibration (Non operation)	① 5 to 100Hz, 11.76m/s^2 ② 1 minute/cycle ③ X, Y, Z direction ④ 10 times each directions	No display malfunctions Note1 No physical damages
Mechanical shock (Non operation)	① 294m/s^2 , 11ms ② X, Y, Z direction ③ 3 times each directions	No display malfunctions Note1 No physical damages
ESD (Operation)	① 150pF, 150Ω , $\pm 10\text{kV}$ ② 9 places on a panel surface Note2 ③ 10 times each places at 1 sec interval	No display malfunctions Note1
Dust (Operation)	① 15 kinds of dust (by JIS-Z8901) ② 15 seconds stir ③ 8 times repeat at 1 hour interval	No display malfunctions Note1

Note1: Display functions are checked under the same conditions as product inspection.

Note2: See the following figure for discharge points.

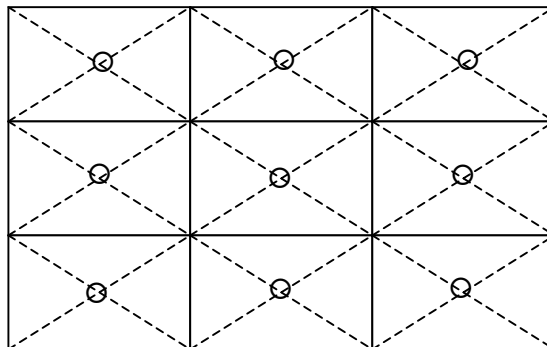

6. PRECAUTIONS

6.1 MEANING OF CAUTION SIGNS

The following caution signs have very important meaning. **Be sure to read "6.2 CAUTIONS", after understanding this contents!**



This sign has the meaning that customer will get an electrical shock, if customer has wrong operations.



This sign has the meaning that customer will be injured by himself, if customer has wrong operations.

6.2 CAUTIONS



Do not touch HIGH VOLTAGE PART of the inverter while turned on! Danger of an electrical shock.



- * Pay attention to burn injury for the working backlight! It may be over 35°C from ambient temperature.
- * Do not shock and press the LCD panel and the backlight! Danger of breaking, because they are made of glass. (Shock: To be not greater 294m/s² and to be not greater 11ms, Pressure: To be not greater 19.6N)

6.3 ATTENTIONS

6.3.1 Handling of the product

- ① Take hold of both ends without touch the circuit board when customer pulls out products (LCD modules) from inner packing box. If customer touches it, products may be broken down or out of adjustment, because of stress to mounting parts.
- ② Do not hook cables nor pull connection cables such as flexible cable and so on, for fear of damage.
- ③ If customer puts down the product temporarily, the product puts on flat subsoil as a display side turns down.
- ④ Take the measures of electrostatic discharge such as earth band, ionic shower and so on, when customer deals with the product, because products may be damaged by electrostatic.
- ⑤ The torque for mounting screws must never exceed 0.39N·m. Higher torque values might result in distortion of the bezel.
- ⑥ Do not press or rub on the sensitive display surface. If customer clean on the panel surface, NEC Corporation recommends using the cloth with ethanolic liquid.
- ⑦ Do not push-pull the interface connectors while the product is working, because wrong power sequence may break down the product.
- ⑧ Do not give the shock or vibration to the normal direction of a display surface, because image quality may fall.

6.3.2 Environment

- ① Do not operate in dewdrop atmosphere and corrosive gases.
- ② Do not operate or store in high temperature or high humidity atmosphere. Keep the product in antistatic pouch in room temperature, because of avoidance for dusts and sunlight, if customer stores the product.
- ③ Do not operate in high magnetic field. Circuit boards may be broken down by it.
- ④ Use an original protection sheet on the product surface (polarizer). Adhesive type protection sheet should be avoided, because it may change color or properties of the polarizer.

6.3.3 Characteristics

The following items are neither defects nor failures.

- ① Response time, luminance and color may be changed by ambient temperature.
- ② The LCD may be seemed luminance non-uniformity, flicker, vertical seam or small spot by display patterns.
- ③ Optical characteristics (e.g. luminance, display uniformity, etc.) gradually is going to change depending on operating time, and especially low temperature, because the LCD has cold cathode fluorescent lamps.
- ④ Do not display the fixed pattern for a long time because it may cause image sticking. Use a screen saver, if the fixed pattern is displayed on the screen.
- ⑤ The display color may be changed by viewing angle because of the use of condenser sheet in the backlight unit.
- ⑥ The luminance may be changed by voltage variation (voltage drop), even if power source applies recommended voltage to backlight inverter.
- ⑦ Optical characteristics may be changed by input signal timings.

6.3.4 Other

- ① All GND, GNDB, VCC and VDDB terminals should be used without a non-connected line.
- ② Do not disassemble a product or adjust volume without permission of NEC Corporation.
- ③ See 'REPLACEMENT MANUAL FOR BACKLIGHT', if customer would like to replace backlight lamps.
- ④ Pay attention not to insert waste materials inside of products, if customer uses screwdrivers.
- ⑤ Pack the product with original shipping package, because of avoidance of some damages during transportation, when customer returns it to NEC Corporation for repair and so on.

7. OUTLINE DRAWINGS

7.1 FRONT VIEW

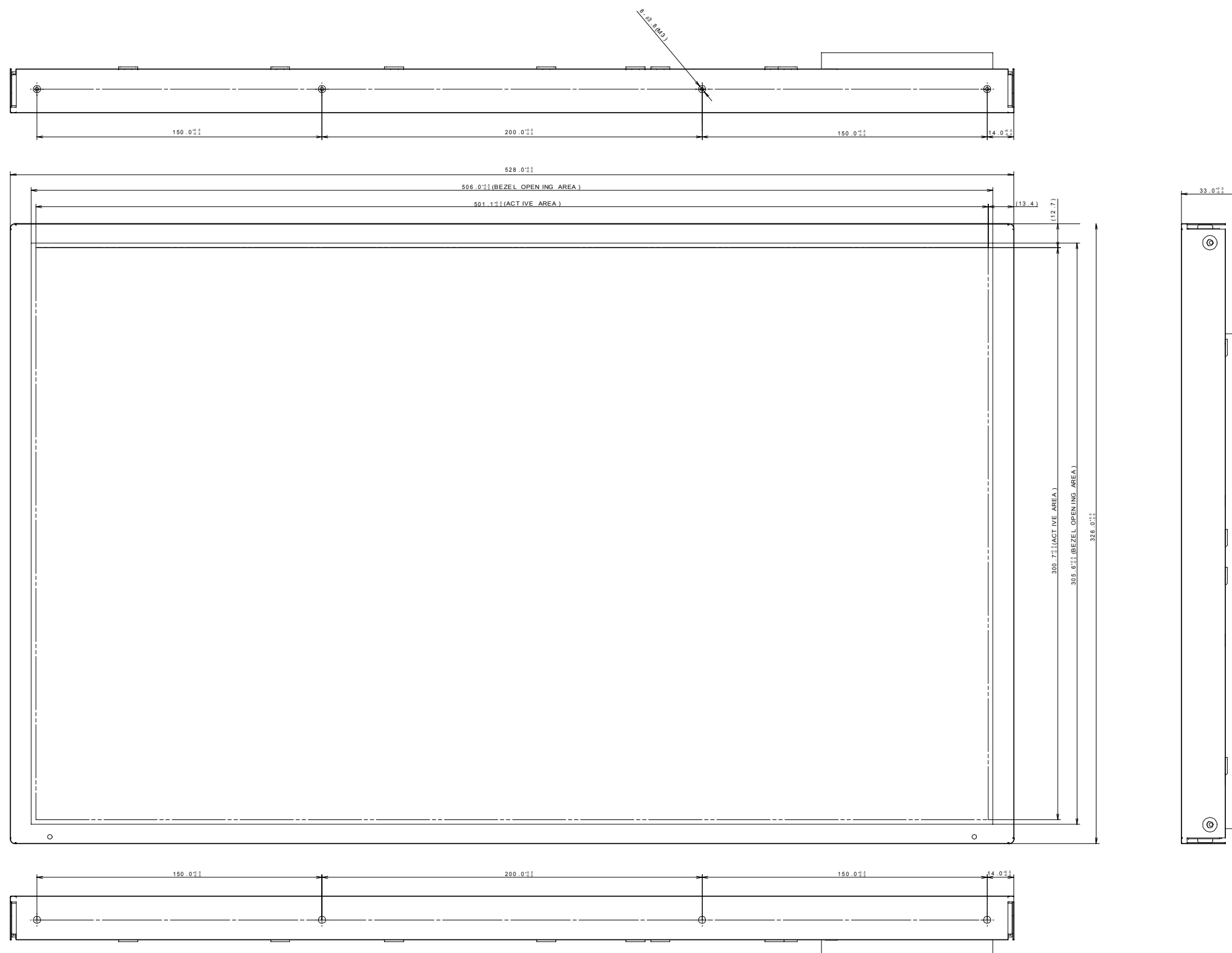

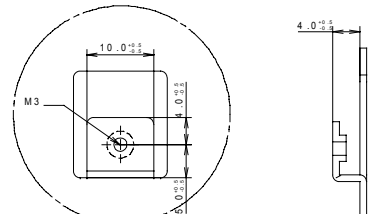
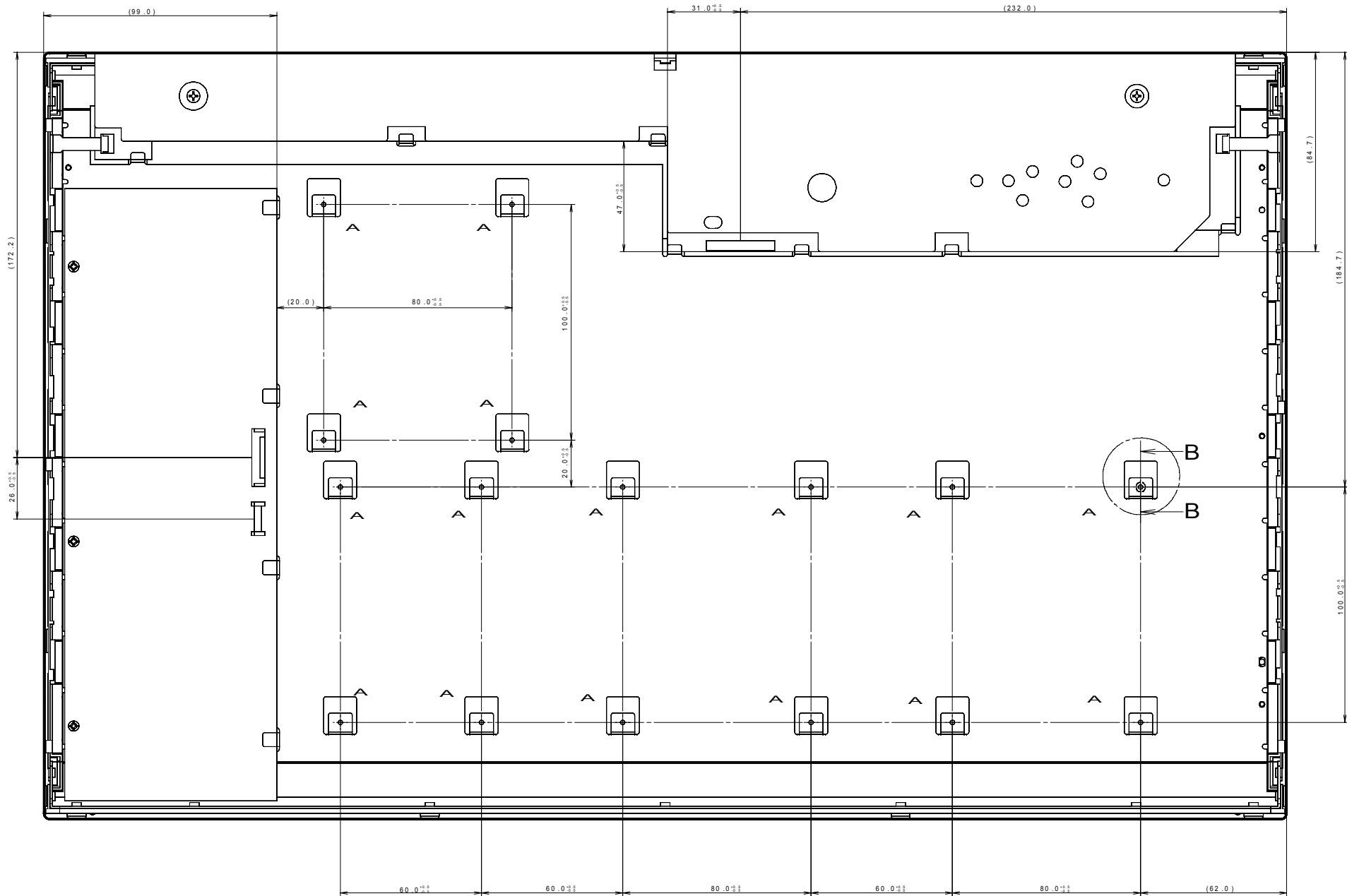

7.2 REAR VIEW

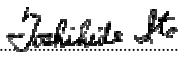

de t a i l A sec B - B

REVISION HISTORY

Edition	Document number	Prepared date	Revision contents and writer																																																																																																																																																				
2nd edition	DOD - M - 0550	Jul. 30, 2001	<p>(4) page 14/28 4.5.4 Connection between receiver and transmitter for LVDS Transmitter for LVDS THC63LVDM83A Receiver for LVDS Equivalent of THC63LVDF84A</p> <p>→ page 14/29 4.5.4 Connection between receiver and transmitter for LVDS Transmitter for LVDS THC63LVD823 Receiver for LVDS Equivalent of THC63LVD824</p> <p>(5) page 20/28 4.10.3 Timing characteristics</p> <table border="1" style="width: 100%; border-collapse: collapse; margin-bottom: 10px;"> <thead> <tr> <th>Parameter</th> <th>Note1</th> <th>Symbol</th> <th>Min.</th> <th>Typ.</th> <th>Max.</th> <th>Unit</th> <th>Remarks</th> </tr> </thead> <tbody> <tr> <td rowspan="3">CLK</td> <td>Frequency (LVDS receiver)</td> <td>1/tc</td> <td>78.0</td> <td>81.0</td> <td>84.0</td> <td>MHz</td> <td>12.34 ns (Typ.)</td> </tr> <tr> <td>Duty</td> <td>tch/tc</td> <td colspan="4" rowspan="10" style="text-align: center; vertical-align: middle;">Note2</td> <td rowspan="10" style="text-align: center; vertical-align: middle;">-</td> </tr> <tr> <td>Rise, fall</td> <td>tcrf</td> </tr> <tr> <td rowspan="2">DATA</td> <td rowspan="2">CLK-DATA</td> <td>Setup timing</td> <td>tds</td> </tr> <tr> <td>Hold timing</td> <td>tdh</td> </tr> <tr> <td></td> <td>Rise, fall</td> <td>tdrf</td> </tr> <tr> <td rowspan="6">DE</td> <td rowspan="2">Horizontal</td> <td>Cycle period</td> <td>thc</td> </tr> <tr> <td>Display period</td> <td>thd</td> </tr> <tr> <td rowspan="2">Vertical (One frame)</td> <td>Cycle</td> <td>tvc</td> </tr> <tr> <td>Display period</td> <td>tvd</td> </tr> <tr> <td rowspan="2">CLK-DE</td> <td>Setup timing</td> <td>tes</td> </tr> <tr> <td>Hold timing</td> <td>teh</td> </tr> <tr> <td></td> <td>Rise, fall</td> <td>terf</td> </tr> </tbody> </table> <p style="margin-left: 40px;">Note1: All parameters should be kept within the specified range. Note2: See the data sheet of LVDS transmitter.</p> <p>→ page 20/29 4.10.3 Timing characteristics</p> <table border="1" style="width: 100%; border-collapse: collapse; margin-bottom: 10px;"> <thead> <tr> <th>Parameter</th> <th>Note1</th> <th>Symbol</th> <th>Min.</th> <th>Typ.</th> <th>Max.</th> <th>Unit</th> <th>Remarks</th> </tr> </thead> <tbody> <tr> <td rowspan="3">CLK</td> <td>Frequency (LVDS receiver)</td> <td>1/tc</td> <td>78.0</td> <td>81.0</td> <td>84.0</td> <td>MHz</td> <td>12.3 ns (typ.)</td> </tr> <tr> <td>Duty</td> <td>tch/tc</td> <td>-</td> <td>-</td> <td>-</td> <td>-</td> <td rowspan="3" style="text-align: center; vertical-align: middle;">Note1</td> </tr> <tr> <td>Rise time, Fall time</td> <td>tcrf</td> <td>-</td> <td>-</td> <td>-</td> <td>-</td> </tr> <tr> <td rowspan="2">DATA</td> <td rowspan="2">CLK-DATA</td> <td>Setup time</td> <td>tds</td> <td>-</td> <td>-</td> <td>-</td> </tr> <tr> <td>Hold time</td> <td>tdh</td> <td>-</td> <td>-</td> <td>-</td> </tr> <tr> <td></td> <td>Rise time, Fall time</td> <td>tdrf</td> <td>-</td> <td>-</td> <td>-</td> <td>-</td> </tr> <tr> <td rowspan="6">DE</td> <td rowspan="2">Horizontal</td> <td>Cycle</td> <td>th</td> <td>-</td> <td>1,688</td> <td>-</td> <td>CLK</td> </tr> <tr> <td>Display period</td> <td>thd</td> <td>-</td> <td>1,280</td> <td>-</td> <td>CLK</td> </tr> <tr> <td rowspan="2">Vertical (One frame)</td> <td>Cycle</td> <td>tv</td> <td>-</td> <td>806</td> <td>-</td> <td>H</td> </tr> <tr> <td>Display period</td> <td>tvd</td> <td>-</td> <td>768</td> <td>-</td> <td>H</td> </tr> <tr> <td rowspan="2">CLK-DE</td> <td>Setup time</td> <td>tdes</td> <td>-</td> <td>-</td> <td>-</td> <td>-</td> </tr> <tr> <td>Hold time</td> <td>tdeh</td> <td>-</td> <td>-</td> <td>-</td> <td>-</td> </tr> <tr> <td></td> <td>Rise time, Fall time</td> <td>tderf</td> <td>-</td> <td>-</td> <td>-</td> <td>-</td> </tr> </tbody> </table> <p style="margin-left: 40px;">Note1: See the data sheet of LVDS transmitter. Note2: "th" must keep the fluctuation within ± 1 CLK, because of avoidance of image sticking. Note3: Definition of units is as follows.</p>	Parameter	Note1	Symbol	Min.	Typ.	Max.	Unit	Remarks	CLK	Frequency (LVDS receiver)	1/tc	78.0	81.0	84.0	MHz	12.34 ns (Typ.)	Duty	tch/tc	Note2				-	Rise, fall	tcrf	DATA	CLK-DATA	Setup timing	tds	Hold timing	tdh		Rise, fall	tdrf	DE	Horizontal	Cycle period	thc	Display period	thd	Vertical (One frame)	Cycle	tvc	Display period	tvd	CLK-DE	Setup timing	tes	Hold timing	teh		Rise, fall	terf	Parameter	Note1	Symbol	Min.	Typ.	Max.	Unit	Remarks	CLK	Frequency (LVDS receiver)	1/tc	78.0	81.0	84.0	MHz	12.3 ns (typ.)	Duty	tch/tc	-	-	-	-	Note1	Rise time, Fall time	tcrf	-	-	-	-	DATA	CLK-DATA	Setup time	tds	-	-	-	Hold time	tdh	-	-	-		Rise time, Fall time	tdrf	-	-	-	-	DE	Horizontal	Cycle	th	-	1,688	-	CLK	Display period	thd	-	1,280	-	CLK	Vertical (One frame)	Cycle	tv	-	806	-	H	Display period	tvd	-	768	-	H	CLK-DE	Setup time	tdes	-	-	-	-	Hold time	tdeh	-	-	-	-		Rise time, Fall time	tderf	-	-	-	-
Parameter	Note1	Symbol	Min.	Typ.	Max.	Unit	Remarks																																																																																																																																																
CLK	Frequency (LVDS receiver)	1/tc	78.0	81.0	84.0	MHz	12.34 ns (Typ.)																																																																																																																																																
	Duty	tch/tc	Note2				-																																																																																																																																																
	Rise, fall	tcrf																																																																																																																																																					
DATA	CLK-DATA	Setup timing						tds																																																																																																																																															
		Hold timing						tdh																																																																																																																																															
	Rise, fall	tdrf																																																																																																																																																					
DE	Horizontal	Cycle period						thc																																																																																																																																															
		Display period						thd																																																																																																																																															
	Vertical (One frame)	Cycle						tvc																																																																																																																																															
		Display period						tvd																																																																																																																																															
	CLK-DE	Setup timing						tes																																																																																																																																															
		Hold timing	teh																																																																																																																																																				
	Rise, fall	terf																																																																																																																																																					
Parameter	Note1	Symbol	Min.	Typ.	Max.	Unit	Remarks																																																																																																																																																
CLK	Frequency (LVDS receiver)	1/tc	78.0	81.0	84.0	MHz	12.3 ns (typ.)																																																																																																																																																
	Duty	tch/tc	-	-	-	-	Note1																																																																																																																																																
	Rise time, Fall time	tcrf	-	-	-	-																																																																																																																																																	
DATA	CLK-DATA	Setup time	tds	-	-	-																																																																																																																																																	
		Hold time	tdh	-	-	-																																																																																																																																																	
	Rise time, Fall time	tdrf	-	-	-	-																																																																																																																																																	
DE	Horizontal	Cycle	th	-	1,688	-	CLK																																																																																																																																																
		Display period	thd	-	1,280	-	CLK																																																																																																																																																
	Vertical (One frame)	Cycle	tv	-	806	-	H																																																																																																																																																
		Display period	tvd	-	768	-	H																																																																																																																																																
	CLK-DE	Setup time	tdes	-	-	-	-																																																																																																																																																
		Hold time	tdeh	-	-	-	-																																																																																																																																																
	Rise time, Fall time	tderf	-	-	-	-																																																																																																																																																	
Signature of writer																																																																																																																																																							
Approved by	Checked by	Prepared by																																																																																																																																																					
 T. ITO _____	 A. SAWADA																																																																																																																																																					