

PRELIMINARY

NLT Technologies, Ltd.

TFT COLOR LCD MODULE

NL160120AC27-32

54 cm (21.3 Type)

UXGA

LVDS Interface (2 port)

PRELIMINARY DATA SHEET

DOD-PP-1268 (2nd edition)

This PRELIMINARY DATA SHEET is updated document from DOD-PP-1244(1).

All information is subject to change without notice. Please confirm the sales representative before starting to design your system.

PRELIMINARY

NLT Technologies, Ltd.

NL160120AC27-32

INTRODUCTION

The Copyright to this document belongs to NLT Technologies, Ltd. (hereinafter called "NLT"). No part of this document will be used, reproduced or copied without prior written consent of NLT.

NLT does and will not assume any liability for infringement of patents, copyrights or other intellectual property rights of any third party arising out of or in connection with application of the products described herein except for that directly attributable to mechanisms and workmanship thereof. No license, express or implied, is granted under any patent, copyright or other intellectual property right of NLT.

Some electronic parts/components would fail or malfunction at a certain rate. In spite of every effort to enhance reliability of products by NLT, the possibility of failures and malfunction might not be avoided entirely. To prevent the risks of damage to death, human bodily injury or other property arising out thereof or in connection therewith, each customer is required to take sufficient measures in its safety designs and plans including, but not limited to, redundant system, fire-containment and anti-failure.

The products are classified into three quality grades: "**Standard**", "**Special**", and "**Specific**" of the highest grade of a quality assurance program at the choice of a customer. Each quality grade is designed for applications described below. Any customer who intends to use a product for application other than that of Standard quality grade is required to contact an NLT sales representative in advance.

The **Standard** quality grade applies to the products developed, designed and manufactured in accordance with the NLT standard quality assurance program, which are designed for such application as any failure or malfunction of the products (sets) or parts/components incorporated therein a customer uses are, directly or indirectly, free of any damage to death, human bodily injury or other property, like general electronic devices.

Examples: Computers, office automation equipment, communications equipment, test and measurement equipment, audio and visual equipment, home electronic appliances, machine tools, personal electronic equipment, industrial robots, etc.

The **Special** quality grade applies to the products developed, designed and manufactured in accordance with an NLT quality assurance program stricter than the standard one, which are designed for such application as any failure or malfunction of the products (sets) or parts/components incorporated therein a customer uses might directly cause any damage to death, human bodily injury or other property, or such application under more severe condition than that defined in the Standard quality grade without such direct damage.

Examples: Control systems for transportation equipment (automobiles, trains, ships, etc.), traffic control systems, anti-disaster systems, anti-crime systems, medical equipment not specifically designed for life support, safety equipment, etc.

The **Specific** quality grade applies to the products developed, designed and manufactured in accordance with the standards or quality assurance program designated by a customer who requires an extremely higher level of reliability and quality for such products.

Examples: Military systems, aircraft control equipment, aerospace equipment, nuclear reactor control systems, medical equipment/devices/systems for life support, etc.

The quality grade of this product is the "**Standard**" unless otherwise specified in this document.

PRELIMINARY

NLT Technologies, Ltd.

NL160120AC27-32

CONTENTS

INTRODUCTION	2
1. OUTLINE.....	4
1.1 STRUCTURE AND PRINCIPLE.....	4
1.2 APPLICATION.....	4
1.3 FEATURES.....	4
2. GENERAL SPECIFICATIONS	5
3. BLOCK DIAGRAM.....	6
4. DETAILED SPECIFICATIONS	7
4.1 MECHANICAL SPECIFICATIONS.....	7
4.2 ABSOLUTE MAXIMUM RATINGS	7
4.3 ELECTRICAL CHARACTERISTICS.....	8
4.3.1 LCD panel signal processing board.....	8
4.3.2 LED Driver board.....	9
4.3.3 LED driver board current wave	9
4.4 POWER SUPPLY VOLTAGE SEQUENCE	11
4.4.1 LCD panel signal processing board	11
4.4.2 LED driver board.....	11
4.5 CONNECTIONS AND FUNCTIONS FOR INTERFACE PINS.....	12
4.5.1 LCD panel signal processing board.....	12
4.5.2 LED driver board.....	13
4.5.3 Positions of socket.....	14
4.6 LUMINANCE CONTROL.....	15
4.6.1 Luminance control methods.....	15
4.6.2 Detail of BRTP timing	16
4.7 LVDS DATA INPUT MAP.....	17
4.7.1 Mode A	17
4.7.2 Mode B	18
4.7.3 Mode C	19
4.8 DISPLAY COLORS AND INPUT DATA SIGNALS	20
4.9 INPUT SIGNAL TIMINGS.....	21
4.9.1 Timing characteristics	21
4.9.2 Input signal timing chart.....	21
4.10 LVDS DATA TRANSMISSION METHOD	22
4.11 DISPLAY POSITIONS.....	22
4.12 PIXEL ARRANGMENT	23
4.13 OPTICS.....	24
4.13.1 Optical characteristics.....	24
4.13.2 Definition of contrast ratio.....	25
4.13.3 Definition of luminance uniformity	25
4.13.4 Definition of response times	26
4.13.5 Definition of viewing angles.....	26
5. ESTIMATED LUMINANCE LIFETIME.....	26
6. RELIABILITY TESTS.....	27
7. PRECAUTIONS	28
7.1 MEANING OF CAUTION SIGNS	28
7.2 CAUTIONS	28
7.3 ATTENTIONS	28
7.3.1 Handling of the product.....	28
7.3.2 Environment.....	29
7.3.3 Characteristics.....	30
7.3.4 Others.....	30
8. OUTLINE DRAWINGS	31
8.1 FRONT VIEW	31
8.2 REAR VIEW	32
REVISION HISTORY	33

PRELIMINARY

NLT Technologies, Ltd.

NL160120AC27-32

1. OUTLINE

1.1 STRUCTURE AND PRINCIPLE

Color LCD module NL160120AC27-32 is composed of the amorphous silicon thin film transistor liquid crystal display (a-Si TFT LCD) panel structure with driver LSIs for driving the TFT (Thin Film Transistor) array and a backlight.

The a-Si TFT LCD panel structure is injected liquid crystal material into a narrow gap between the TFT array glass substrate and a color-filter glass substrate.

Grayscale data signals from a host system (e.g. signal generator, etc.) are modulated into best form for active matrix system by a signal processing board, and sent to the driver LSIs which drive the individual TFT arrays.

The TFT array as an electro-optical switch regulates the amount of transmitted light from the backlight assembly, when it is controlled by data signals. Color images are created by regulating the amount of transmitted light through the TFT array of red, green and blue dots.

1.2 APPLICATION

- Color monitor system

1.3 FEATURES

- Ultra-wide viewing angle (Ultra-Advanced Super Fine TFT (UA-SFT))
- High luminance
- High contrast
- High resolution
- Low reflection
- Wide color gamut
- 256 gray scale in each R, G, B sub-pixel (8-bit), 16,777,216 colors
- LVDS interface
- Selectable LVDS data input map
- Small foot print
- Long life LED backlight type with an LED driver board

PRELIMINARY

NLT Technologies, Ltd.

NL160120AC27-32

2. GENERAL SPECIFICATIONS

Display area	432.0 (H) × 324.0 (V) mm
Diagonal size of display	54 cm (21.3 inches)
Drive system	a-Si TFT active matrix
Display color	16,777,216 colors
Pixel	1,600 (H) × 1,200 (V) pixels (1 pixel consists of 3 sub-pixels (RGB).)
Pixel arrangement	RGB (Red dot, Green dot, Blue dot) vertical stripe
Dot pitch	0.090 (H) × 0.270 (V) mm
Pixel pitch	0.270 (H) × 0.270 (V) mm
Module size	457.0 (W) × 350.0 (H) × 21.5 (D) mm (typ.)
Weight	(2,700) g (typ.)
Contrast ratio	1400:1 (typ.)
Viewing angle	At the contrast ratio ≥ 10:1 <ul style="list-style-type: none"> • Horizontal: Right side 88° (typ.), Left side 88° (typ.) • Vertical: Up side 88° (typ.), Down side 88° (typ.)
Designed viewing direction	Viewing angle with optimum grayscale ($\gamma \approx$ DICOM): normal axis (perpendicular) Note1
Polarizer surface	Antiglare
Polarizer pencil-hardness	2H (min.) [by JIS K5600]
Color gamut	At LCD panel center (72) % (typ.) [against NTSC color space]
Response time	$T_{on} + T_{off}$ (10% ← → 90%) (40) ms (typ.)
Luminance	At the maximum luminance 900 cd/m ² (typ.)
Signal system	2 ports LVDS interface (THC63LVD824A THine Electronics, Inc. or equivalent) [RGB 8-bit signals, Data enable signal (DE), Dot clock (CK)]
Power supply voltage	LCD panel signal processing board: 12.0V LED driver board: 12.0V
Backlight	LED backlight type with LED driver board
Power consumption	At checkered flag pattern, the maximum luminance (57) W (typ.)

Note1: When the product luminance is 450cd/m², the gamma characteristic is designed to $\gamma \approx$ DICOM.

PRELIMINARY

NLT Technologies, Ltd.

NL160120AC27-32

3. BLOCK DIAGRAM

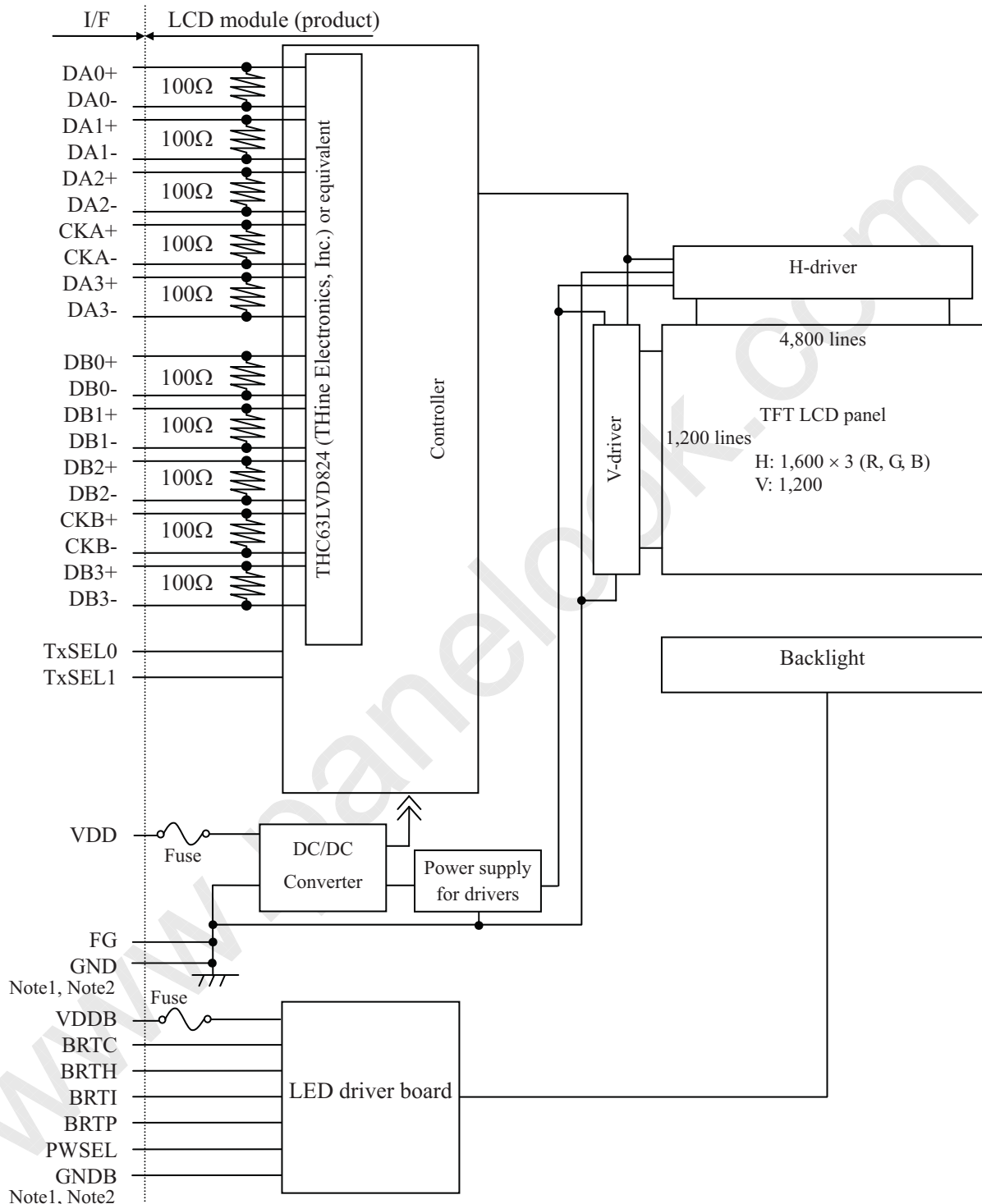

Note1: Relations between GND (Signal ground), FG (Frame ground) and GNDB (LED driver board ground) in the LCD module are as follows.

GND - FG	Connected
GND - GNDB	Not connected
FG - GNDB	Not connected

Note2: GND, FG and GNDB must be connected to customer equipment's ground, and it is recommended that these grounds be connected together in customer equipment.

PRELIMINARY

NLT Technologies, Ltd.

NL160120AC27-32

4. DETAILED SPECIFICATIONS

4.1 MECHANICAL SPECIFICATIONS

Parameter	Specification	Unit
Module size	457.0 ±0.5 (W) × 350.0 ±0.5 (H) × 21.5 (typ., D) 23.0 (max. D)	mm
Display area	432.0 (H) × 324.0 (V)	mm
Weight	(2,700) (typ.), (2,980) (max.)	g

Note1: Excluding warpage of the cover for LED driver board.

Note2: See "8. OUTLINE DRAWINGS".

4.2 ABSOLUTE MAXIMUM RATINGS

Parameter		Symbol	Rating	Unit	Remarks	
Power supply voltage	LCD panel signal processing board	VDD	-0.3 to +14.0	V	Ta = 25°C	
	LED driver board	VDDDB	-0.3 to +15.0	V		
Input voltage for signals	LCD panel signal processing board Note1	Vi	-0.3 to +3.45	V	VDD= 12.0V	
	LED driver board	BRTI signal	VBI	-0.3 to +1.5	V	VDDDB= 12.0V
		BRTP signal	VBP	-0.3 to +5.5	V	
		BRTC signal	VBC	-0.3 to +5.5	V	
		PWSEL signal	VBS	-0.3 to +5.5	V	
Storage temperature		Tst	-20 to +60	°C	-	
Operating temperature	Front surface	TopF	(0 to +60)	°C	Note2	
	Rear surface	TopR	(0 to +60)	°C	Note3	
Relative humidity Note4	RH	≤ 95	%	Ta ≤ 40°C		
		≤ 85	%	40°C < Ta ≤ 50°C		
		≤ 70	%	50°C < Ta ≤ 55°C		
Absolute humidity Note4	AH	≤ 73 Note5	g/m ³	Ta > 55°C		
Operating altitude	-	≤ 4,850	m	0°C ≤ Ta ≤ 55°C		
Storage altitude	-	≤ 13,600	m	-20°C ≤ Ta ≤ 60°C		

Note1: DA0+/-, DA1+/-, DA2+/-, DA3+/-, CKA+/-, DB0+/-, DB1+/-, DB2+/-, DB3+/-, CKB+/-

Note2: Measured at LCD panel surface (including self-heat)

Note3: Measured at LCD module's rear shield surface (including self-heat)

Note4: No condensation

Note5: Water amount at Ta = 55°C and RH = 70%

PRELIMINARY

NLT Technologies, Ltd.

NL160120AC27-32

4.3 ELECTRICAL CHARACTERISTICS

4.3.1 LCD panel signal processing board

(Ta = 25°C)

Parameter	Symbol	min.	typ.	max.	Unit	Remarks	
Power supply voltage	VDD	10.8	12.0	13.2	V	-	
Power supply current	IDD	-	(500) Note1	(700) Note2	mA	at VDD= 12.0V	
Permissible ripple voltage	VRP	-	-	100	mVp-p	for VDD	
Differential input threshold voltage	High	VTH	-	-	+100	mV	at VCM= 1.2V Note3, Note4
	Low	VTL	-100	-	-	mV	
Input voltage swing	VI	0	-	2.4	V	Note4	
Terminating resistance	RT	-	100	-	Ω	-	

Note1: Checkered flag pattern (by EIAJ ED-2522)

Note2: Pattern for maximum current

Note3: Common mode voltage for LVDS driver

Note4: DA0+/-, DA1+/-, DA2+/-, DA3+/-, CKA+/-, DB0+/-, DB1+/-, DB2+/-, DB3+/-, CKB+/-

PRELIMINARY

NLT Technologies, Ltd.

NL160120AC27-32

4.3.2 LED Driver board

(Ta = 25°C)

Parameter		Symbol	min.	typ.	max.	Unit	Remarks
Power supply voltage		VDDDB	(11.4)	12.0	(12.6)	V	-
Power supply current		IDDB	-	(4,200)	TBD	mA	VDDDB= 12.0V, At the maximum luminance control
Input voltage for signals	BRTI signal		VBI	0	-	1.0	V
	BRTP signal	High	VBPH	2.0	-	5.25	V
		Low	VBPL	0	-	0.8	V
	BRTC signal	High	VBCH	2.0	-	5.25	V
		Low	VBCL	0	-	0.8	V
	PWSEL signal	High	VBSH	2.0	-	5.25	V
Low		VBSL	0	-	0.8	V	
Input current for signals	BRTI signal		IBI	TBD	-	TBD	μA
	BRTP signal	High	IBPH	-	-	TBD	μA
		Low	IBPL	TBD	-	-	μA
	BRTC signal	High	IBCH	-	-	TBD	μA
		Low	IBCL	TBD	-	-	μA
	PWSEL signal	High	IPSH	-	-	TBD	μA
Low		IPSL	TBD	-	-	μA	

4.3.3 LED driver board current wave

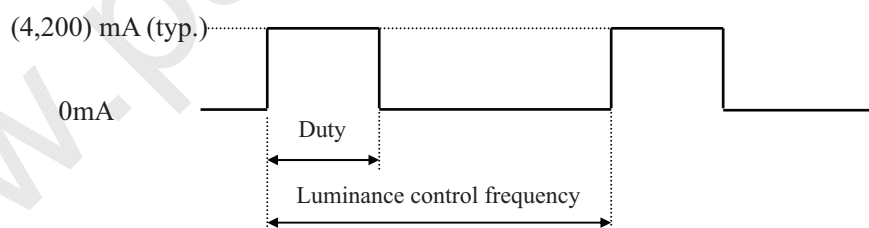

At the maximum luminance control: 100%

At the minimum luminance control: (1)% (At frequency: 325 Hz)

Luminance control frequency: (255)Hz (typ.)

Note1: Luminance control frequency indicate the input pulse frequency, when select the external pulse control. See "4.6.2 Detail of BRTP timing".

Note2: The power supply lines (VDDDB and GNDB) have large ripple voltage during luminance control. There is the possibility that the ripple voltage produces acoustic noise and signal wave noise in audio circuit and so on. Put a capacitor (5,000 to 6,000μF) between the power supply lines (VDDDB and GNDB) to reduce the noise, if the noise occurred in the circuit..

PRELIMINARY

NLT Technologies, Ltd.

NL160120AC27-32

4.3.4 Power supply voltage ripple

2

This product works, even if the ripple voltage levels are beyond the permissible values as following the table, but there might be noise on the display image.

Power supply voltage		Ripple voltage (Measure at input terminal of power supply)	Unit
VDD	12.0V	≤ 100	mVp-p
VDDDB	12.0V	≤ 200	mVp-p

Note1: The permissible ripple voltage includes spike noise.

Example of the power supply connection

a) Separate the power supply

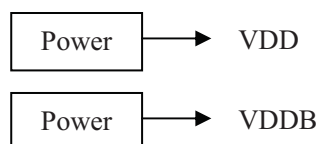

b) Put in the filter

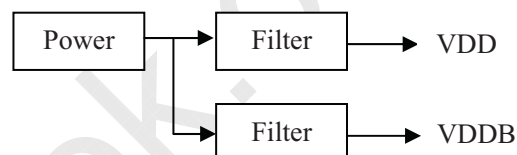

4.3.5 Fuse

2

Parameter	Fuse		Rating	Fusing current	Remarks
	Type	Supplier			
VDD	FCC16132AB	KAMAYA ELECTRIC Co., Ltd.	1.25A	2.5A, 5 seconds maximum	Note1
			32V		
VDDDB	CCF1N10	KOA Corporation	10A	20 A, 1 seconds maximum	
			60 V		

Note1: The power supply capacity should be more than the fusing current. If it is less than the fusing current, the fuse may not blow in a short time, and then nasty smell, smoke and so on may occur.

PRELIMINARY

NLT Technologies, Ltd.

NL160120AC27-32

4.4 POWER SUPPLY VOLTAGE SEQUENCE

4.4.1 LCD panel signal processing board

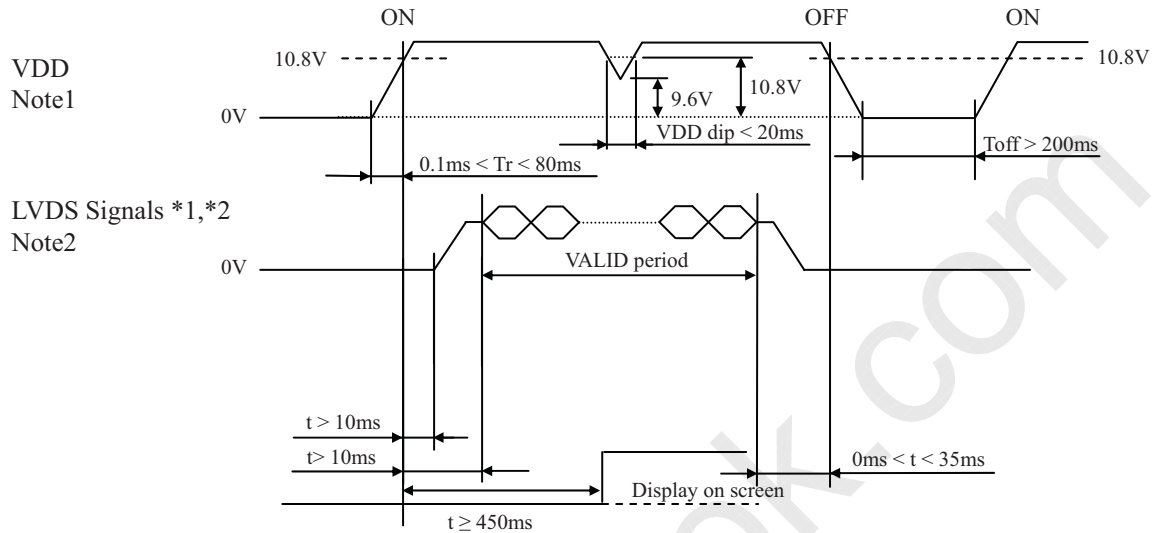

*1: DA0+/-, DA1+/-, DA2+/-, DA3+/-, CKA+/-, DB0+/-, DB1+/-, DB2+/-, DB3+/- and CKB+/-

*2: LVDS signals should be measured at the terminal of 100Ω resistance.

Note1: If there is a voltage variation (voltage drop) at the rising edge of VCC below 10.8V, there is a possibility that a product does not work due to a protection circuit.

Note2: LVDS signals must be set to Low or High-impedance, except the VALID period (See above sequence diagram), in order to avoid the circuitry damage.

If some of signals are cut while this product is working, even if the signal input to it once again, it might not work normally. If a customer stops the display and function signals, VCC also must be shut down.

Note3: The backlight should be turned on within the valid period of LVDS signals, in order to avoid unstable data display.

4.4.2 LED driver board

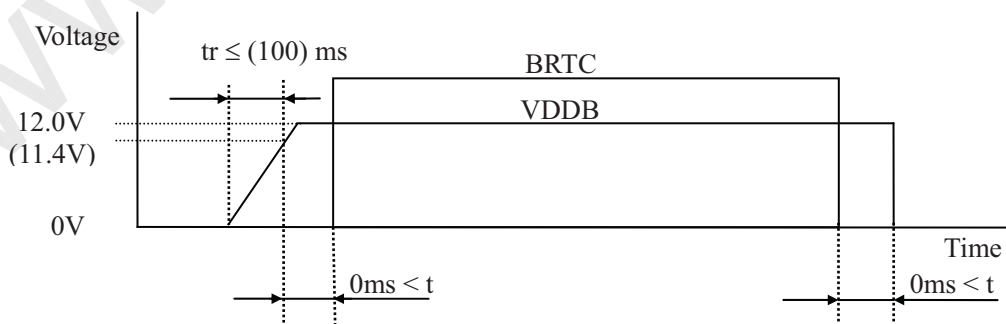

Note1: The backlight should be turned on within the valid period of LVDS signals, in order to avoid unstable data display.

Note2: If tr is more than (100)ms, the backlight will be turned off by a protection circuit for LED driver board. 2

Note3: When VDDB is 0V or BRTC is Low, PWSEL must be set to Low or Open.

PRELIMINARY

NLT Technologies, Ltd.

NL160120AC27-32

4.5 CONNECTIONS AND FUNCTIONS FOR INTERFACE PINS

4.5.1 LCD panel signal processing board

CN1 Socket (LCD module side): DF19G-30P-1H (56) (Hirose Electric Co., Ltd. (HRS))

Adaptable plug: DF19-30S-1C (Hirose Electric Co., Ltd. (HRS))

Pin No.	Symbol	Signal	Remarks																
1	DA0-	Pixel data A0	Odd pixel data Input (LVDS differential signal) Note1																
2	DA0+																		
3	DA1-	Pixel data A1	Odd pixel data Input (LVDS differential signal) Note1																
4	DA1+																		
5	DA2-	Pixel data A2	Odd pixel data Input (LVDS differential signal) Note1																
6	DA2+																		
7	GND	Ground	Signal ground Note2																
8	CKA-	Pixel clock	Odd pixel clock Input (LVDS differential signal) Note1																
9	CKA+																		
10	DA3-	Pixel data A3	Odd pixel data Input (LVDS differential signal) Note1																
11	DA3+																		
12	DB0-	Pixel data B0	Even pixel data Input (LVDS differential signal) Note1																
13	DB0+																		
14	GND	Ground	Signal ground Note2																
15	DB1-	Pixel data B1	Even pixel data Input (LVDS differential signal) Note1																
16	DB1+																		
17	GND	Ground	Signal ground Note2																
18	DB2-	Pixel data B2	Even pixel data Input (LVDS differential signal) Note1																
19	DB2+																		
20	CKB-	Pixel clock	Even pixel clock Input (LVDS differential signal) Note1																
21	CKB+																		
22	DB3-	Pixel data B3	Even pixel data Input (LVDS differential signal) Note1																
23	DB3+																		
24	GND	Ground	Signal ground Note2																
25	TxSEL0	Selection of LVDS data input map	Note3, Note4	<table border="1"> <thead> <tr> <th>TxSEL1</th> <th>TxSEL0</th> <th>Mode</th> </tr> </thead> <tbody> <tr> <td>Open</td> <td>Open</td> <td>A</td> </tr> <tr> <td>Open</td> <td>Low</td> <td>B</td> </tr> <tr> <td>Low</td> <td>Open</td> <td>C</td> </tr> <tr> <td>Low</td> <td>Low</td> <td>A</td> </tr> </tbody> </table>	TxSEL1	TxSEL0	Mode	Open	Open	A	Open	Low	B	Low	Open	C	Low	Low	A
TxSEL1	TxSEL0			Mode															
Open	Open			A															
Open	Low			B															
Low	Open	C																	
Low	Low	A																	
26	TxSEL1																		
27	GND	Ground	Signal ground Note2																
28	VDD	Power supply	12V Note2																
29	VDD																		
30	VDD																		

Note1: Twist pair wires with 100Ω (Characteristic impedance) should be used between LCD panel signal processing board and LVDS transmitter.

Note2: All GND and VDD terminals should be used without any non-connected lines.

Note3: This terminal is pulled-up in the product.

Note4: See "4.7 LVDS DATA INPUT MAP".

PRELIMINARY

NLT Technologies, Ltd.

NL160120AC27-32

4.5.2 LED driver board

CN201 socket (LCD module side): DF3Z-10P-2H (2*) (HIROSE ELECTRIC Co., Ltd.)

Adaptable plug: DF3-10S-2C (HIROSE ELECTRIC Co., Ltd.)

Pin No.	Symbol	Function	Description
1	GNDB	LED driver board ground	Note1
2	GNDB		
3	GNDB		
4	GNDB		
5	GNDB		
6	VDDB	Power supply	Note1
7	VDDB		
8	VDDB		
9	VDDB		
10	VDDB		

Note1: All VDDB and GNDB terminals should be used without any non-connected lines.

CN202 socket (LCD module side): IL-Z-9PL-SMTYE (Japan Aviation Electronics Industry Limited (JAE))

Adaptable plug: IL-Z-9S-S125C3 (Japan Aviation Electronics Industry Limited (JAE))

Pin No.	Symbol	Function	Description
1	GNDB	LED driver board ground	Note1
2	GNDB		
3	N.C.	-	Keep this pin Open.
4	BRTC	Backlight ON/OFF control signal	High or Open: Backlight ON Low: Backlight OFF
5	BRTH	Luminance control terminal	Note2
6	BRTI		
7	BRTP	BRTP signal	
8	GNDB	LED driver board ground	Note1
9	PWSEL	Selection of luminance control signal method	Note2, Note3

Note1: All GNDB terminals should be used without any non-connected lines.

Note2: See "4.6.1 LUMINANCE CONTROL".

Note3: When VDDB is 0V or BRTC is Low, PWSEL must be set to Low or Open.

PRELIMINARY

NLT Technologies, Ltd.

NL160120AC27-32

4.5.3 Positions of socket

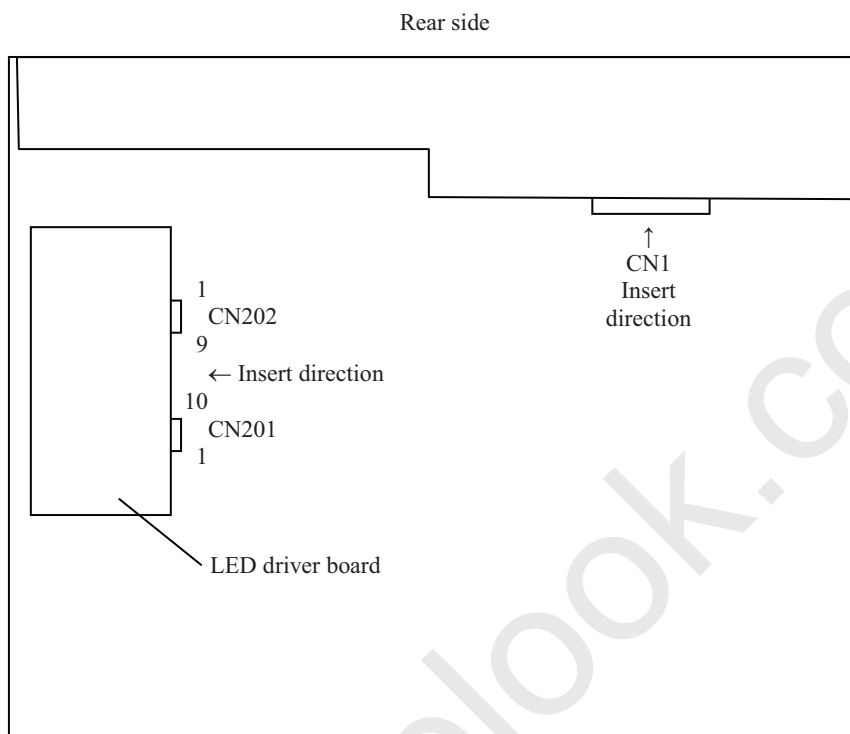

PRELIMINARY

NLT Technologies, Ltd.

NL160120AC27-32

4.6 LUMINANCE CONTROL

4.6.1 Luminance control methods

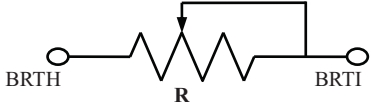
Method	Adjustment and luminance ratio	PWSEL terminal	BRTP terminal						
Variable resistor control Note1	<ul style="list-style-type: none"> Adjustment <p>The variable resistor (R) for luminance control should be 10kΩ ±5%, 1/10W. Minimum point of the resistance is the minimum luminance and maximum point of the resistance is the maximum luminance. The resistor (R) must be connected between BRTH-BRTI terminals.</p>  <ul style="list-style-type: none"> Luminance ratio Note3 <table border="1"> <thead> <tr> <th>Resistance</th> <th>Luminance ratio</th> </tr> </thead> <tbody> <tr> <td>0Ω</td> <td>0%(Min. Luminance)</td> </tr> <tr> <td>10 kΩ</td> <td>100% (Max. Luminance)</td> </tr> </tbody> </table>	Resistance	Luminance ratio	0Ω	0%(Min. Luminance)	10 kΩ	100% (Max. Luminance)	High or Open	Open
Resistance	Luminance ratio								
0Ω	0%(Min. Luminance)								
10 kΩ	100% (Max. Luminance)								
Voltage control Note1	<ul style="list-style-type: none"> Adjustment <p>Voltage control method works, when BRTH terminal is 0V and VBI voltage is input between BRTI-BRTH terminals. This control method can carry out continuation adjustment of luminance. Luminance is the maximum when BRTI terminal is Open.</p> <ul style="list-style-type: none"> Luminance ratio Note3 <table border="1"> <thead> <tr> <th>BRTI Voltage (VBI)</th> <th>Luminance ratio</th> </tr> </thead> <tbody> <tr> <td>0V</td> <td>0% (Min. Luminance)</td> </tr> <tr> <td>1.0V</td> <td>100% (Max. Luminance)</td> </tr> </tbody> </table>	BRTI Voltage (VBI)	Luminance ratio	0V	0% (Min. Luminance)	1.0V	100% (Max. Luminance)		
BRTI Voltage (VBI)	Luminance ratio								
0V	0% (Min. Luminance)								
1.0V	100% (Max. Luminance)								
Pulse width modulation Note1 Note2 Note4	<ul style="list-style-type: none"> Adjustment <p>Pulse width modulation (PWM) method works, when PWSEL terminal is Low and PWM signal (BRTP signal) is input into BRTP terminal. The luminance is controlled by duty ratio of BRTP signal.</p> <ul style="list-style-type: none"> Luminance ratio Note3 <table border="1"> <thead> <tr> <th>Duty ratio</th> <th>Luminance ratio</th> </tr> </thead> <tbody> <tr> <td>(0.01)</td> <td>(1)% (Min. Luminance) (At frequency: 325 Hz)</td> </tr> <tr> <td>1.0</td> <td>100% (Max. Luminance)</td> </tr> </tbody> </table>	Duty ratio	Luminance ratio	(0.01)	(1)% (Min. Luminance) (At frequency: 325 Hz)	1.0	100% (Max. Luminance)	Low	BRTP signal
Duty ratio	Luminance ratio								
(0.01)	(1)% (Min. Luminance) (At frequency: 325 Hz)								
1.0	100% (Max. Luminance)								

Note1: In case of the variable resistor control method and the voltage control method, noises may appear on the display image depending on the input signals timing for LCD panel signal processing board.

Use PWM method, if interference noises appear on the display image!

Note2: The LED driver board will stop working, if the Low period of BRTP signal is more than 50ms while BRTP signal is High or Open. Then the backlight will not turn on anymore, even if BRTP signal is input again. This is not out of order. The LED driver board will start to work when power is supplied again.

Note3: These data are the target values.

Note4: See "4.6.2 Detail of BRTP timing".

PRELIMINARY

NLT Technologies, Ltd.

NL160120AC27-32

4.6.2 Detail of BRTP timing

(1) Timing diagrams

• Outline chart

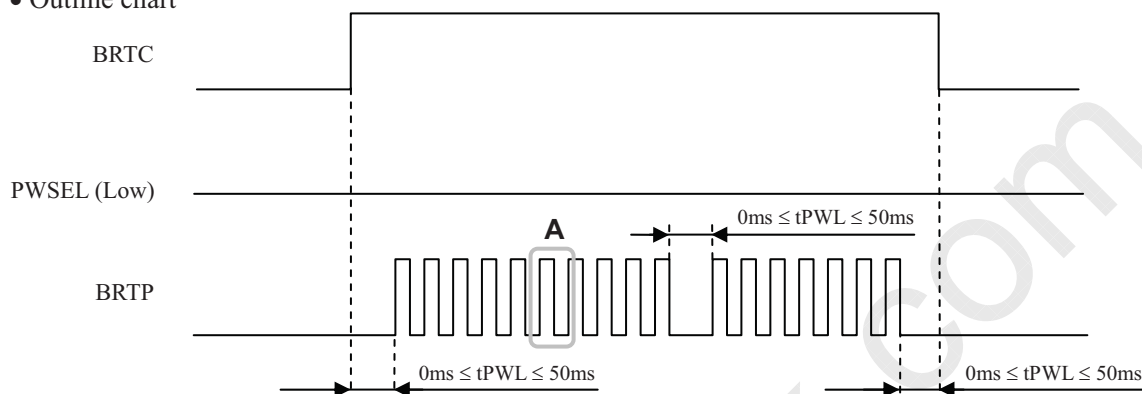

• Detail of A part

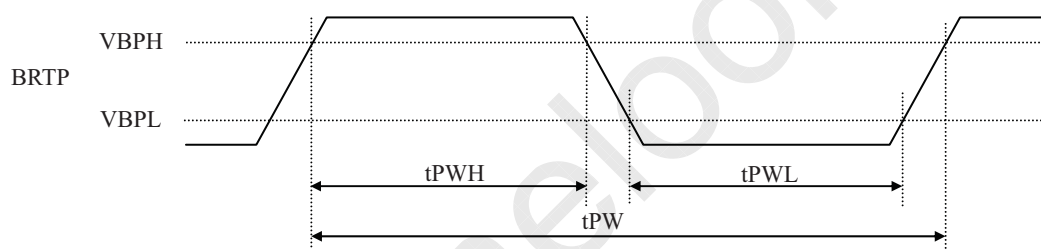

(2) Each parameter

Parameter	Symbol	min.	typ.	max.	Unit	Remarks
Luminance control frequency	FL	(185)	-	(1,000)	Hz	Note1, Note2
External PWM pulse width	tPWH	(30)	-	-	μs	Note1, Note3

Note1: Definition of parameters is as follows.

$$FL = \frac{1}{tPW} \quad DL = \frac{tPWH}{tPW}$$

Note2: See the following formula for luminance control frequency.

$$\text{Luminance control frequency} = 1/tv \times (n+0.25) \text{ [or } (n + 0.75)]$$

$$n = 1, 2, 3 \dots \dots$$

tv: Vertical cycle (See "4.9.1 Timing characteristics".)

The interference noise of luminance control frequency and input signal frequency for LCD panel signal processing board may appear on a display. Set up luminance control frequency so that the interference noise does not appear!

Note3: See "4.6.1 Luminance control methods".

PRELIMINARY

NLT Technologies, Ltd.

NL160120AC27-32

4.7 LVDS DATA INPUT MAP

4.7.1 Mode A

Input data		Transmitter		CN1						
		Pin	THC63LVDM83D			Pin	THC63LVD823B			
Odd pixel data and control signal	Note1	RA2	→ 51	TA0	53	R12	Note2	Pin	Symbol	
		RA3	→ 52	TA1	54	R13	TA1-	→ 1	DA0-	
		RA4	→ 54	TA2	57	R14	TA1+	→ 2	DA0+	
		RA5	→ 55	TA3	58	R15				
		RA6	→ 56	TA4	59	R16	TB1-	→ 3	DA1-	
		RA7	→ 3	TA5	60	R17	TB1+	→ 4	DA1+	
		GA2	→ 4	TA6	63	G12				
		GA3	→ 6	TB0	64	G13	TC1-	→ 5	DA2-	
		GA4	→ 7	TB1	65	G14	TC1+	→ 6	DA2+	
		GA5	→ 11	TB2	66	G15				
		GA6	→ 12	TB3	67	G16	TCLK1-	→ 8	CKA-	
		GA7	→ 14	TB4	68	G17	TCLK1+	→ 9	CKA+	
		BA2	→ 15	TB5	73	B12				
		BA3	→ 19	TB6	74	B13	TD1-	→ 10	DA3-	
		BA4	→ 20	TC0	75	B14	TD1+	→ 11	DA3+	
		BA5	→ 22	TC1	76	B15				
		BA6	→ 23	TC2	77	B16				
		BA7	→ 24	TC3	78	B17				
		Note3	RSVD	→ 27	TC4	7	RSVD			
		Note3	RSVD	→ 28	TC5	8	RSVD			
			DE	→ 30	TC6	9	DE			
			RA0	→ 50	TD0	51	R10			
			RA1	→ 2	TD1	52	R11			
			GA0	→ 8	TD2	61	G10			
			GA1	→ 10	TD3	62	G11			
			BA0	→ 16	TD4	69	B10			
			BA1	→ 18	TD5	70	B11			
		Note3	RSVD	→ 25	TD6	-				
			CLK	→ 31	CLKIN	10	CLK			
	Even pixel data		RB2	→ 51	TA0	81	R22	TA2-	→ 12	DB0-
			RB3	→ 52	TA1	82	R23	TA2+	→ 13	DB0+
		RB4	→ 54	TA2	83	R24				
		RB5	→ 55	TA3	84	R25	TB2-	→ 14	GND	
		RB6	→ 56	TA4	85	R26	TB2+	→ 15	DB1-	
		RB7	→ 3	TA5	86	R27				
		GB2	→ 4	TA6	91	G22				
		GB3	→ 6	TB0	92	G23	TC2-	→ 18	DB2-	
		GB4	→ 7	TB1	93	G24	TC2+	→ 19	DB2+	
		GB5	→ 11	TB2	94	G25				
		GB6	→ 12	TB3	95	G26	TCLK2-	→ 20	CKB-	
		GB7	→ 14	TB4	96	G27	TCLK2+	→ 21	CKB+	
		BB2	→ 15	TB5	99	B22				
		BB3	→ 19	TB6	100	B23	TD2-	→ 22	DB3-	
		BB4	→ 20	TC0	1	B24	TD2+	→ 23	DB3+	
		BB5	→ 22	TC1	2	B25				
		BB6	→ 23	TC2	5	B26				
		BB7	→ 24	TC3	6	B27				
		Note3	RSVD	→ 27	TC4	-				
		Note3	RSVD	→ 28	TC5	-				
		Note3	RSVD	→ 30	TC6	-				
			RB0	→ 50	TD0	79	R20			
			RB1	→ 2	TD1	80	R21			
			GB0	→ 8	TD2	89	G20			
			GB1	→ 10	TD3	90	G21			
			BB0	→ 16	TD4	97	B20			
			BB1	→ 18	TD5	98	B21			
		Note3	RSVD	→ 25	TD6	-				
			CLK	→ 31	CLKIN	-				

2

PRELIMINARY

NLT Technologies, Ltd.

NL160120AC27-32

4.7.2 Mode B

Input data		Note1	Transmitter		CN1		
			Pin	DS90CF383, C385		Pin Symbol	
Odd pixel data and control signal	RA7	→	51	TXIN0	Note2	1 DA0-	
	RA6	→	52	TXIN1	TA1- →	2 DA0+	
	RA5	→	54	TXIN2	TA1+ →		
	RA4	→	55	TXIN3			
	RA3	→	56	TXIN4	TB1- →	3 DA1-	
	RA2	→	3	TXIN6	TB1+ →	4 DA1+	
	GA7	→	4	TXIN7			
	GA6	→	6	TXIN8	TC1- →	5 DA2-	
	GA5	→	7	TXIN9	TC1+ →	6 DA2+	
	GA4	→	11	TXIN12		7 GND	
	GA3	→	12	TXIN13	TCLK1- →	8 CKA-	
	GA2	→	14	TXIN14	TCLK1+ →	9 CKA+	
	BA7	→	15	TXIN15			
	BA6	→	19	TXIN18	TD1- →	10 DA3-	
	BA5	→	20	TXIN19	TD1+ →	11 DA3+	
	BA4	→	22	TXIN20			
	BA3	→	23	TXIN21			
	BA2	→	24	TXIN22			
	Note3	RSVD	→	27	TXIN24		
	Note3	RSVD	→	28	TXIN25		
		DE	→	30	TXIN26		
		RA1	→	50	TXIN27		
		RA0	→	2	TXIN5		
		GA1	→	8	TXIN10		
		GA0	→	10	TXIN11		
		BA1	→	16	TXIN16		
		BA0	→	18	TXIN17		
	Note3	RSVD	→	25	TXIN23		
		CLK	→	31	CLKIN		
	Even pixel data	RB7	→	51	TXIN0		
		RB6	→	52	TXIN1	TA2- →	12 DB0-
RB5		→	54	TXIN2	TA2+ →	13 DB0+	
RB4		→	55	TXIN3		14 GND	
RB3		→	56	TXIN4	TB2- →	15 DB1-	
RB2		→	3	TXIN6	TB2+ →	16 DB1+	
GB7		→	4	TXIN7		17 GND	
GB6		→	6	TXIN8	TC2- →	18 DB2-	
GB5		→	7	TXIN9	TC2+ →	19 DB2+	
GB4		→	11	TXIN12			
GB3		→	12	TXIN13	TCLK2- →	20 CKB-	
GB2		→	14	TXIN14	TCLK2+ →	21 CKB+	
BB7		→	15	TXIN15			
BB6		→	19	TXIN18	TD2- →	22 DB3-	
BB5		→	20	TXIN19	TD2+ →	23 DB3+	
BB4		→	22	TXIN20		24 GND	
BB3		→	23	TXIN21		25 TxSEL0	
BB2		→	24	TXIN22		26 TxSEL1	
Note3		RSVD	→	27	TXIN24		27 GND
Note3		RSVD	→	28	TXIN25		28 VDD
Note3		RSVD	→	30	TXIN26		29 VDD
		RB1	→	50	TXIN27		30 VDD
		RB0	→	2	TXIN5		
		GB1	→	8	TXIN10		
		GB0	→	10	TXIN11		
		BB1	→	16	TXIN16		
		BB0	→	18	TXIN17		
Note3		RSVD	→	25	TXIN23		
		CLK	→	31	CLKIN		

PRELIMINARY

NLT Technologies, Ltd.

NL160120AC27-32

4.7.3 Mode C

Input data		Note1	Transmitter		CN1			
			Pin	DS90CF383, C385				
Odd pixel data and control signal	RA0	→	51	TXIN0	Note2	Pin	Symbol	
	RA1	→	52	TXIN1		TA1-	→	1 DA0-
	RA2	→	54	TXIN2		TA1+	→	2 DA0+
	RA3	→	55	TXIN3				
	RA4	→	56	TXIN4		TB1-	→	3 DA1-
	RA5	→	3	TXIN6		TB1+	→	4 DA1+
	GA0	→	4	TXIN7				
	GA1	→	6	TXIN8		TC1-	→	5 DA2-
	GA2	→	7	TXIN9		TC1+	→	6 DA2+
	GA3	→	11	TXIN12				7 GND
	GA4	→	12	TXIN13		TCLK1-	→	8 CKA-
	GA5	→	14	TXIN14	TCLK1+	→	9 CKA+	
	BA0	→	15	TXIN15				
	BA1	→	19	TXIN18	TD1-	→	10 DA3-	
	BA2	→	20	TXIN19	TD1+	→	11 DA3+	
	BA3	→	22	TXIN20				
	BA4	→	23	TXIN21				
	BA5	→	24	TXIN22				
	Note3	RSVD	→	27	TXIN24			
	Note3	RSVD	→	28	TXIN25			
		DE	→	30	TXIN26			
		RA6	→	50	TXIN27			
		RA7	→	2	TXIN5			
		GA6	→	8	TXIN10			
		GA7	→	10	TXIN11			
		BA6	→	16	TXIN16			
		BA7	→	18	TXIN17			
	Note3	RSVD	→	25	TXIN23			
		CLK	→	31	CLKIN			
	Even pixel data	RB0	→	51	TXIN0	Note2	Pin	Symbol
		RB1	→	52	TXIN1		TA2-	→
RB2		→	54	TXIN2	TA2+		→	13 DB0+
RB3		→	55	TXIN3				14 GND
RB4		→	56	TXIN4	TB2-		→	15 DB1-
RB5		→	3	TXIN6	TB2+		→	16 DB1+
GB0		→	4	TXIN7				17 GND
GB1		→	6	TXIN8	TC2-		→	18 DB2-
GB2		→	7	TXIN9	TC2+		→	19 DB2+
GB3		→	11	TXIN12				
GB4		→	12	TXIN13	TCLK2-		→	20 CKB-
GB5		→	14	TXIN14	TCLK2+	→	21 CKB+	
BB0		→	15	TXIN15				
BB1		→	19	TXIN18	TD2-	→	22 DB3-	
BB2		→	20	TXIN19	TD2+	→	23 DB3+	
BB3		→	22	TXIN20			24 GND	
BB4		→	23	TXIN21			25 TxSEL0	
BB5		→	24	TXIN22			26 TxSEL1	
Note3		RSVD	→	27	TXIN24			27 GND
Note3		RSVD	→	28	TXIN25			28 VDD
Note3		RSVD	→	30	TXIN26			29 VDD
		RB6	→	50	TXIN27			30 VDD
		RB7	→	2	TXIN5			
		GB6	→	8	TXIN10			
		GB7	→	10	TXIN11			
		BB6	→	16	TXIN16			
		BB7	→	18	TXIN17			
Note3		RSVD	→	25	TXIN23			
		CLK	→	31	CLKIN			

PRELIMINARY

NLT Technologies, Ltd.

NL160120AC27-32

Note1: LSB (Least Significant Bit) – RA0, GA0, BA0, RB0, GB0, BB0
 MSB (Most Significant Bit) – RA7, GA7, BA7, RB7, GB7, BB7

Note2: Twist pair wires with 100Ω (Characteristic impedance) should be used between LCD panel signal processing board and LVDS transmitter.

Note3: Input signal RSVD is not used inside the product, but do not keep pin open to avoid noise problem.

4.8 DISPLAY COLORS AND INPUT DATA SIGNALS

This product can display in equivalent to 16,777,216 colors in 256 gray scales in each RGB sub-pixel. Also the relation between display colors and input data signals is as the following table.

Display colors		Data signal (0: Low level, 1: High level)																							
		RA7	RA6	RA5	RA4	RA3	RA2	RA1	RA0	GA7	GA6	GA5	GA4	GA3	GA2	GA1	GA0	BA7	BA6	BA5	BA4	BA3	BA2	BA1	BA0
		RB7	RB6	RB5	RB4	RB3	RB2	RB1	RB0	GB7	GB6	GB5	GB4	GB3	GB2	GB1	GB0	BB7	BB6	BB5	BB4	BB3	BB2	BB1	BB0
Basic Colors	Black	0	0	0	0	0	0	0	0	0	0	0	0	0	0	0	0	0	0	0	0	0	0	0	0
	Blue	0	0	0	0	0	0	0	0	0	0	0	0	0	0	0	0	1	1	1	1	1	1	1	1
	Red	1	1	1	1	1	1	1	1	0	0	0	0	0	0	0	0	0	0	0	0	0	0	0	0
	Magenta	1	1	1	1	1	1	1	1	0	0	0	0	0	0	0	0	1	1	1	1	1	1	1	1
	Green	0	0	0	0	0	0	0	0	1	1	1	1	1	1	1	1	0	0	0	0	0	0	0	0
	Cyan	0	0	0	0	0	0	0	0	1	1	1	1	1	1	1	1	1	1	1	1	1	1	1	1
	Yellow	1	1	1	1	1	1	1	1	1	1	1	1	1	1	1	1	0	0	0	0	0	0	0	0
	White	1	1	1	1	1	1	1	1	1	1	1	1	1	1	1	1	1	1	1	1	1	1	1	1
Red gray scale	Black	0	0	0	0	0	0	0	0	0	0	0	0	0	0	0	0	0	0	0	0	0	0	0	0
		0	0	0	0	0	0	0	1	0	0	0	0	0	0	0	0	0	0	0	0	0	0	0	0
	dark	0	0	0	0	0	0	1	0	0	0	0	0	0	0	0	0	0	0	0	0	0	0	0	0
	↑																								
	↓																								
bright	1	1	1	1	1	1	0	1	0	0	0	0	0	0	0	0	0	0	0	0	0	0	0	0	
	1	1	1	1	1	1	1	0	0	0	0	0	0	0	0	0	0	0	0	0	0	0	0	0	
Red	1	1	1	1	1	1	1	1	0	0	0	0	0	0	0	0	0	0	0	0	0	0	0	0	
Green gray scale	Black	0	0	0	0	0	0	0	0	0	0	0	0	0	0	0	0	0	0	0	0	0	0	0	0
		0	0	0	0	0	0	0	0	0	0	0	0	0	0	0	1	0	0	0	0	0	0	0	0
	dark	0	0	0	0	0	0	0	0	0	0	0	0	0	0	1	0	0	0	0	0	0	0	0	0
	↑																								
	↓																								
bright	0	0	0	0	0	0	0	0	1	1	1	1	1	1	0	1	0	0	0	0	0	0	0	0	
	0	0	0	0	0	0	0	0	1	1	1	1	1	1	1	0	0	0	0	0	0	0	0	0	
Green	0	0	0	0	0	0	0	0	1	1	1	1	1	1	1	1	0	0	0	0	0	0	0	0	
Blue gray scale	Black	0	0	0	0	0	0	0	0	0	0	0	0	0	0	0	0	0	0	0	0	0	0	0	0
		0	0	0	0	0	0	0	0	0	0	0	0	0	0	0	0	0	0	0	0	0	0	0	1
	dark	0	0	0	0	0	0	0	0	0	0	0	0	0	0	0	0	0	0	0	0	0	0	1	0
	↑																								
	↓																								
bright	0	0	0	0	0	0	0	0	0	0	0	0	0	0	0	0	1	1	1	1	1	1	0	1	
	0	0	0	0	0	0	0	0	0	0	0	0	0	0	0	0	1	1	1	1	1	1	1	0	
Blue	0	0	0	0	0	0	0	0	0	0	0	0	0	0	0	0	1	1	1	1	1	1	1	1	

PRELIMINARY

NLT Technologies, Ltd.

NL160120AC27-32

4.9 INPUT SIGNAL TIMINGS

4.9.1 Timing characteristics

Parameter	Symbol	min.	typ.	max.	Unit	Remarks	
CLK	Frequency	1/ tc	60.0	64.5	65.0	MHz	LVDS transmitter input
	Pulse width	tc	15.38	15.5	-	ns	
	Duty	-	See the data sheet of LVDS transmitter.			-	
	Rise, fall	-				ns	
Horizontal	Cycle	th	13.1	13.3	19.2	μ s	Note1
			848	860	1,156	CLK	
	Display period	thd	800			CLK	-
Vertical	Cycle	1/tv	59	60	61	Hz	-
		tv	1,206	1,250	-	H	-
	Display period	tvd	1,200			H	-
DE, DATA	Setup time	-	See the data sheet of LVDS transmitter.			ns	-
	Hold time	-				ns	
	Rise, fall	-				ns	

Note1: During operation, fluctuation of horizontal cycle should be within ± 1 CLK.

4.9.2 Input signal timing chart

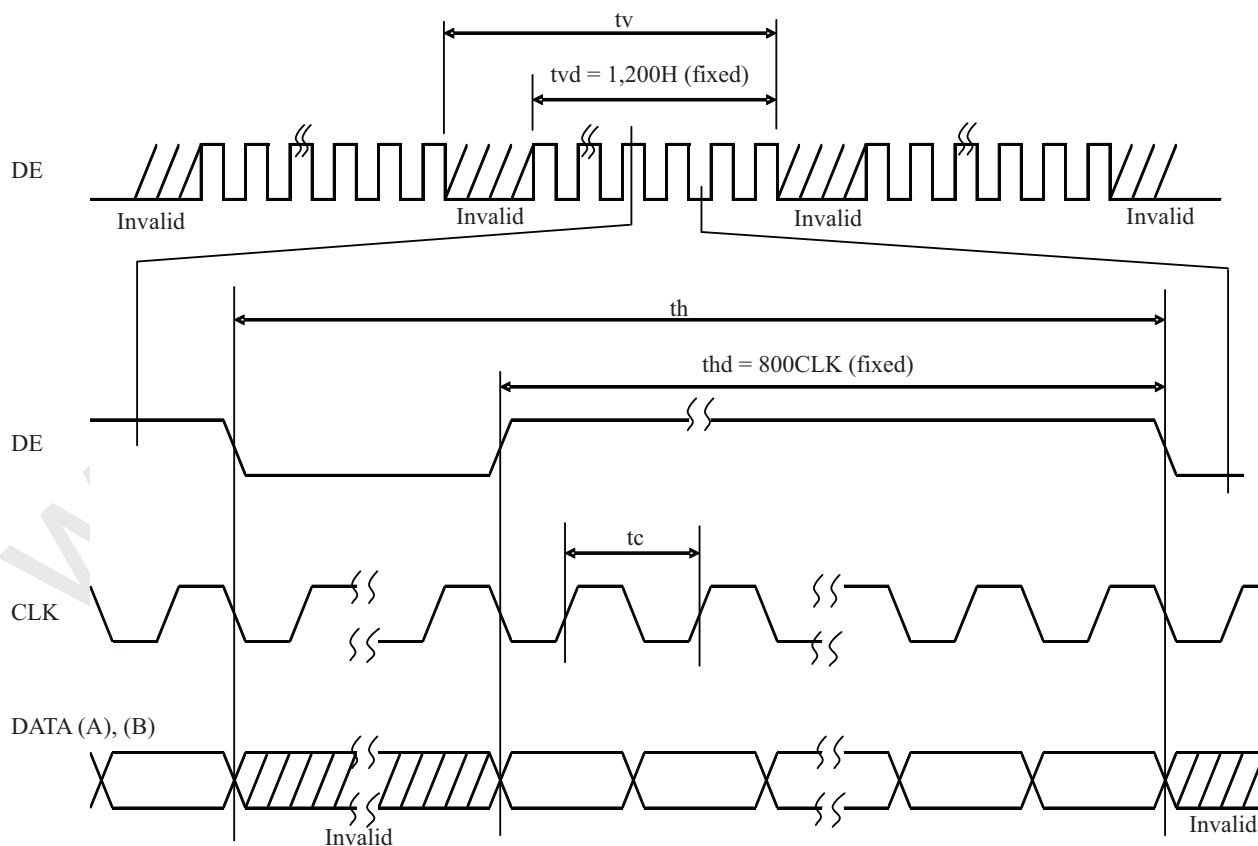

PRELIMINARY

NLT Technologies, Ltd.

NL160120AC27-32

4.10 LVDS DATA TRANSMISSION METHOD

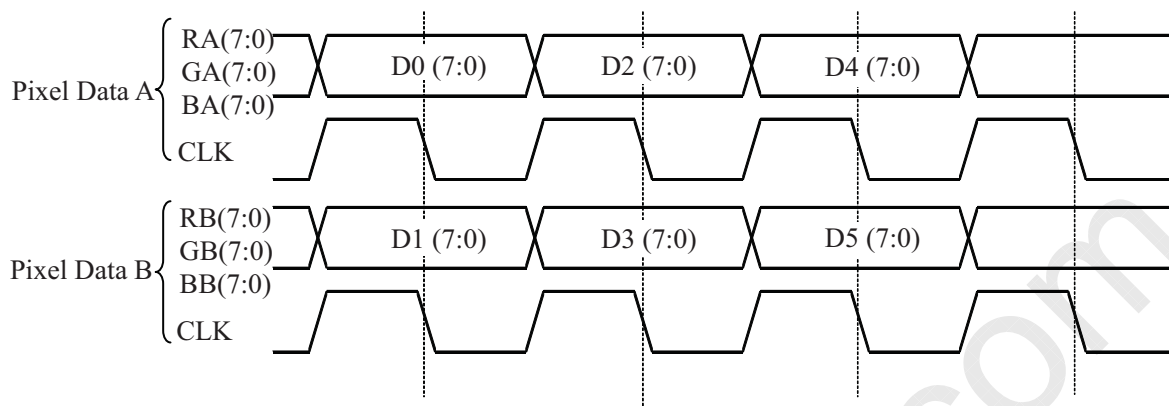

4.11 DISPLAY POSITIONS

Odd pixel: RA= Red data
GA= Green data
BA= Blue data

Even pixel: RB= Red data
GB= Green data
BB= Blue data

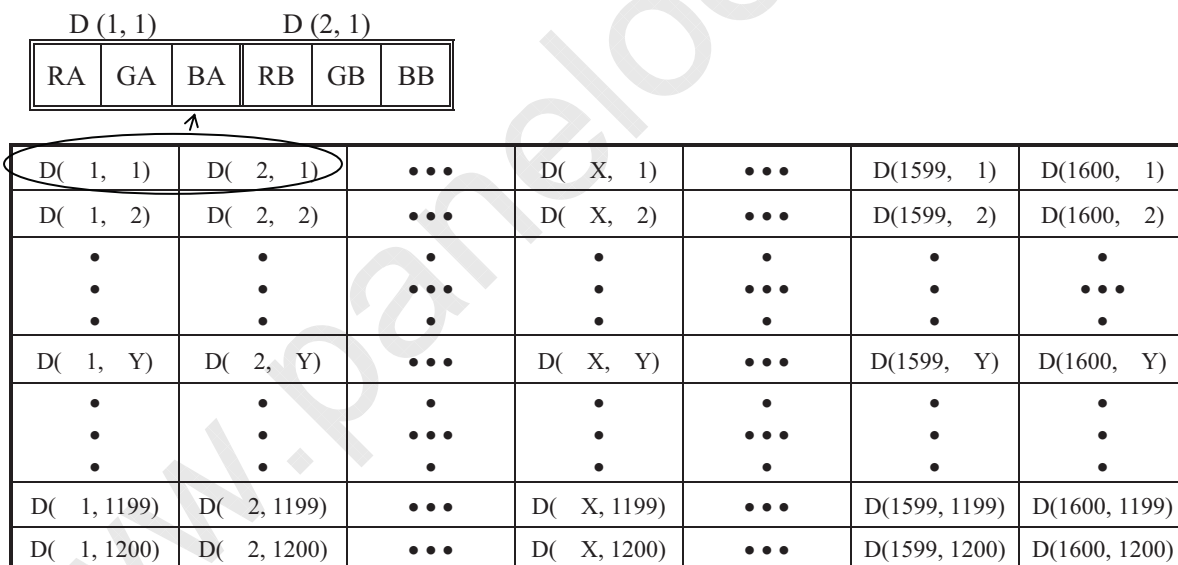

PRELIMINARY

NLT Technologies, Ltd.

NL160120AC27-32

4.12 PIXEL ARRANGMENT

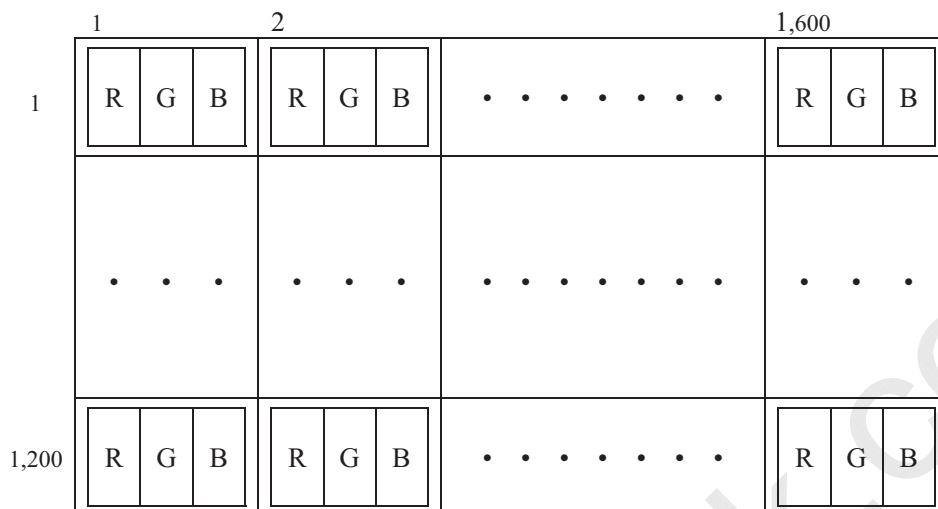

PRELIMINARY

NLT Technologies, Ltd.

NL160120AC27-32

4.13 OPTICS

4.13.1 Optical characteristics

(Note1, Note2)

Parameter	Condition	Symbol	min.	typ.	max.	Unit	Measuring instrument	Remarks
Luminance	White at center $\theta R = 0^\circ, \theta L = 0^\circ, \theta U = 0^\circ, \theta D = 0^\circ$	L	TBD	900	-	cd/m ²	BM-5A or SR-3	Note3
Contrast ratio	White/Black at center $\theta R = 0^\circ, \theta L = 0^\circ, \theta U = 0^\circ, \theta D = 0^\circ$	CR	TBD	1,400	-	-	BM-5A or SR-3	Note3 Note5
Luminance uniformity	255/255 gray scale $\theta R = 0^\circ, \theta L = 0^\circ, \theta U = 0^\circ, \theta D = 0^\circ$	LU1023	(80)	-	-	%	BM-5A or SR-3	Note4 Note6
Chromaticity	White	x coordinate	Wx	(0.269)	0.299			Note3 Note8
		y coordinate	Wy	(0.285)	0.315	(0.345)	-	
	Red	x coordinate	Rx	-	(0.65)	-	-	
		y coordinate	Ry	-	(0.33)	-	-	
	Green	x coordinate	Gx	-	(0.29)	-	-	
		y coordinate	Gy	-	(0.60)	-	-	
Blue	x coordinate	Bx	-	(0.15)	-	-		
	y coordinate	By	-	(0.07)	-	-		
Color uniformity	204/255 gray scale $\theta R = 0^\circ, \theta L = 0^\circ, \theta U = 0^\circ, \theta D = 0^\circ$	$\Delta u'v'$	-	-	0.01	-	SR-3	Note4 Note7
Color gamut	$\theta R = 0^\circ, \theta L = 0^\circ, \theta U = 0^\circ, \theta D = 0^\circ$ at center, against NTSC color space	C	(65)	(72)	-	%	SR-3	Note3
Response time	Black to White	Ton	-	(20)	(30)	ms	BM-5A	Note3 Note9
	White to Black	Toff	-	(20)	(30)	ms		
Viewing angle	Right	$\theta U = 0^\circ, \theta D = 0^\circ, CR \geq 10$	θR	70	88	-	BM-5A or EZ Contrast	Note3 Note10
	Left	$\theta U = 0^\circ, \theta D = 0^\circ, CR \geq 10$	θL	70	88	-		
	Up	$\theta R = 0^\circ, \theta L = 0^\circ, CR \geq 10$	θU	70	88	-		
	Down	$\theta R = 0^\circ, \theta L = 0^\circ, CR \geq 10$	θD	70	88	-		

Note1: These are initial characteristics.

Note2: Measurement conditions are as follows.

Ta = 25°C, VDD = 12.0V, VDDB = 12.0V, PWM: Duty 100%, Display mode: UXGA,
Horizontal cycle = 1/75.19 kHz, Vertical cycle = 1/60.0Hz

Optical characteristics are measured after 20 minutes from working the product, in the dark room.
Also measurement methods are as follows.

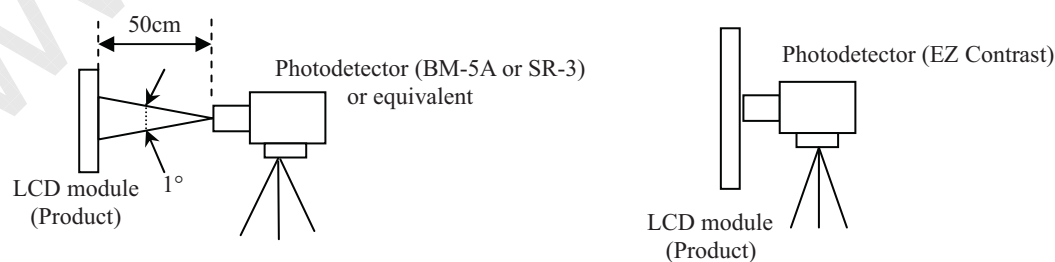

Note3: Product surface temperature at the maximum luminance control: TopF = 32°C

Note4: Product surface temperature at 450cd/m² luminance control: TopF = 30°CTemperature difference in display area: $\Delta TBD^\circ C$

PRELIMINARY

NLT Technologies, Ltd.

NL160120AC27-32

Note5: See "4.13.2 Definition of contrast ratio".

Note6: See "4.13.3 Definition of luminance uniformity".

Note7: See "4.13.4 Definition of color uniformity".

Note8: These coordinates are found on CIE 1931 chromaticity diagram.

Note9: See "4.13.5 Definition of response times".

Note10: See "4.13.6 Definition of viewing angles".

2

4.13.2 Definition of contrast ratio

The contrast ratio is calculated by using the following formula.

$$\text{Contrast ratio (CR)} = \frac{\text{Luminance of white screen}}{\text{Luminance of black screen}}$$

4.13.3 Definition of luminance uniformity

The luminance uniformity is calculated by using following formula.

$$\text{Luminance uniformity (LU)} = \frac{\text{Minimum luminance from ① to ⑤}}{\text{Maximum luminance from ① to ⑤}}$$

The luminance is measured at near the 9 points shown below.

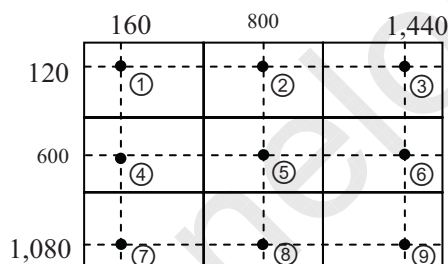

4.13.4 Definition of color uniformity

The color (u' , v') is measured at near the 9 points shown below.

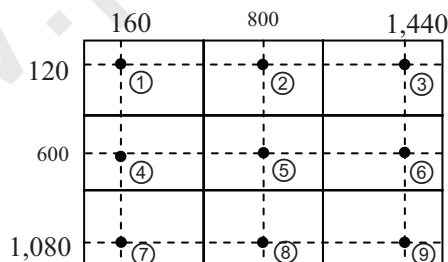

The color uniformity in each measuring point is calculated by using the following formula.

$$\text{Color uniformity}(\Delta u'v') = \sqrt{(u'_x - u'_y)^2 + (v'_x - v'_y)^2}$$

u'_x, v'_x : u' , v' value at measuring point x.

u'_y, v'_y : u' , v' value at measuring point y.

2

PRELIMINARY

NLT Technologies, Ltd.

NL160120AC27-32

4.13.5 Definition of response times

Response time is measured at the time when the luminance changes from "black" to "white", or "white" to "black" on the same screen point, by photo-detector. Ton is the time when the luminance changes from 10% up to 90%. Also Toff is the time when the luminance changes from 90% down to 10% (See the following diagram.).

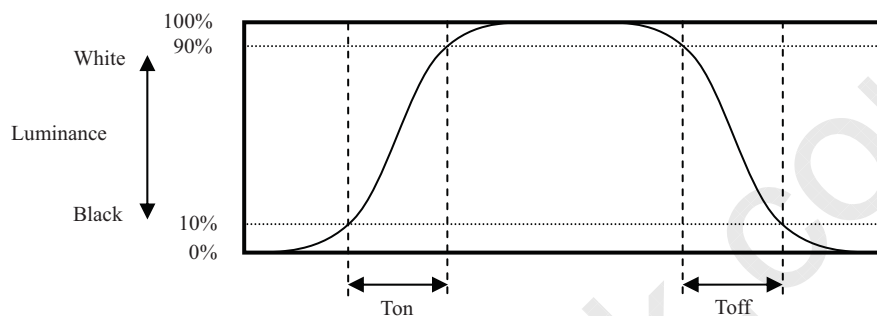

4.13.6 Definition of viewing angles

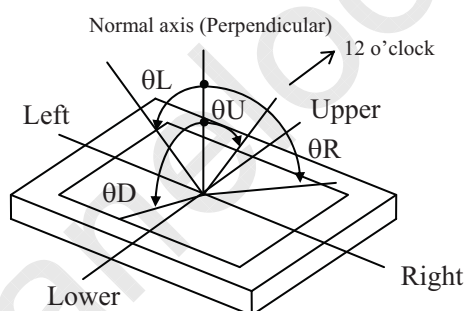

5. ESTIMATED LUMINANCE LIFETIME

The luminance lifetime is the time from initial luminance to half-luminance.

This lifetime is the estimated value, and is not guarantee value.

Condition		Estimated luminance lifetime (Life time expectancy) Note1, Note2, Note3	Unit
LED elementary substance	25°C (Ambient temperature of the product) Continuous operation, PWM: Duty 100%	70,000	h
	60°C (Surface temperature at screen) Continuous operation, PWM: Duty 100%	TBD	

Note1: Life time expectancy is mean time to half-luminance.

Note2: Estimated luminance lifetime is not the value for an LCD module but the value for LED elementary substance.

Note3: By ambient temperature, the lifetime changes particularly. Especially, in case the product works under high temperature environment, the lifetime becomes short.

PRELIMINARY

NLT Technologies, Ltd.

NL160120AC27-32

6. RELIABILITY TESTS

Test item	Condition	Judgment Note1
High temperature and humidity (Operation)	① $60 \pm 2^\circ\text{C}$, RH = 60%, 500hours ② Display data is white. Note2	No display malfunctions
Heat cycle (Operation)	① $0 \pm 3^\circ\text{C}$...1hour $60 \pm 3^\circ\text{C}$...1hour ② 50cycles, 4hours/cycle ③ Display data is white. Note2	
Thermal shock (Non operation)	① $-20 \pm 3^\circ\text{C}$...30minutes $60 \pm 3^\circ\text{C}$...30minutes ② 100cycles, 1hour/cycle ③ Temperature transition time is within 5 minutes.	
Vibration (Non operation)	① 5 to 100Hz, 11.76m/s^2 ② 1 minute/cycle ③ X, Y, Z directions ④ 10 times each directions	No display malfunctions No physical damages
Mechanical shock (Non operation)	① 294m/s^2 , 11ms ② X, Y, Z directions ③ 3 times each directions	No display malfunctions
ESD (Operation)	① 150pF, 150Ω , $\pm 10\text{kV}$ ② 9 places on a panel surface Note3 ③ 10 times each places at 1 sec interval	
Dust (Operation)	① Sample dust: No.15 (by JIS-Z8901) ② 15 seconds stir ③ 8 times repeat at 1 hour interval Note2	
Low pressure	Non-operation	No display malfunctions
	Operation	
	① 15 kPa (Equivalent to altitude 13,600m) ② $-20^\circ\text{C} \pm 3^\circ\text{C}$...24 hours ③ $+60^\circ\text{C} \pm 3^\circ\text{C}$...24 hours	No display malfunctions
	① 53.3 kPa (Equivalent to altitude 4,850m) ② $0^\circ\text{C} \pm 3^\circ\text{C}$...24 hours ③ $+60^\circ\text{C} \pm 3^\circ\text{C}$...24 hours Note2	

Note1: Display and appearance are checked under environmental conditions equivalent to the inspection conditions of defect criteria.

Note2: Luminance: 450cd/m^2 at luminance control.

Note3: See the following figure for discharge points

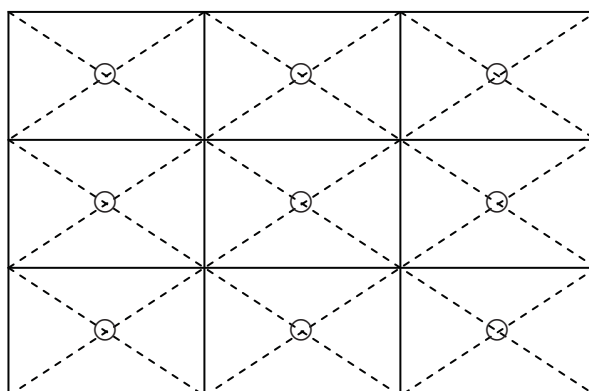

PRELIMINARY

NLT Technologies, Ltd.

NL160120AC27-32

7. PRECAUTIONS

7.1 MEANING OF CAUTION SIGNS

The following caution signs have very important meaning. **Be sure to read "7.2 CAUTIONS" and "7.3 ATTENTIONS"!**



This sign has the meaning that a customer will be injured or the product will sustain damage if the customer practices wrong operations.



This sign has the meaning that a customer will be injured if the customer practices wrong operations.

7.2 CAUTIONS



*** Do not shock and press the LCD panel and the backlight! There is a danger of breaking, because they are made of glass. (Shock: Equal to or no greater than 294m/s^2 and equal to or no greater than 11ms, Pressure: Equal to or no greater than 19.6N ($\phi 16\text{mm}$ jig))**

7.3 ATTENTIONS

7.3.1 Handling of the product

- ① Take hold of both ends without touching the circuit board when the product (LCD module) is picked up from inner packing box to avoid broken down or misadjustment, because of stress to mounting parts on the circuit board.
- ② Do not hook nor pull cables such as lamp cable, and so on, in order to avoid any damage.
- ③ When the product is put on the table temporarily, display surface must be placed downward.
- ④ When handling the product, take the measures of electrostatic discharge with such as earth band, ionic shower and so on, because the product may be damaged by electrostatic.
- ⑤ The torque for product mounting screws must never exceed 0.735N·m. Higher torque might result in distortion of the bezel. And the length of product mounting screws must be $\leq 5.0\text{mm}$.

PRELIMINARY

NLT Technologies, Ltd.

NL160120AC27-32

- ⑥ The product must be installed using mounting holes without undue stress such as bends or twist (See outline drawings). And do not add undue stress to any portion (such as bezel flat area). Bends or twist described above and undue stress to any portion may cause display mura.
Recommended installing method: Ideal plane "A" is defined by one mounting hole (datum point) and other mounting holes. The ideal plane "A" should be the same plane within ± 0.3 mm.

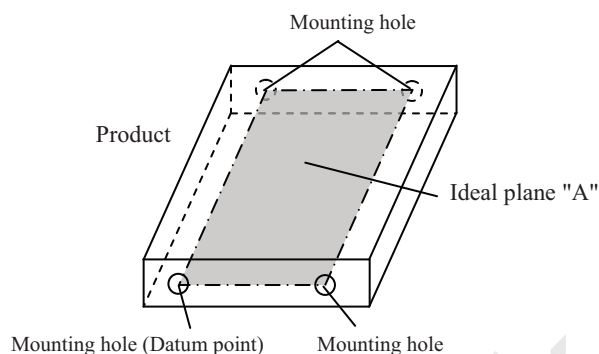

- ⑦ Do not press or rub on the sensitive product surface. When cleaning the product surface, wipe it with a soft dry cloth.
- ⑧ Do not push or pull the interface connectors while the product is working.
- ⑨ When handling the product, use of an original protection sheet on the product surface (polarizer) is recommended for protection of product surface. Adhesive type protection sheet may change color or characteristics of the polarizer.
- ⑩ Usually liquid crystals don't leak through the breakage of glasses because of the surface tension of thin layer and the construction of LCD panel. But, if you contact with liquid crystal by any chance, please wash it away with soap and water.

7.3.2 Environment

- ① Do not operate or store in high temperature, high humidity, dewdrop atmosphere or corrosive gases. Keep the product in packing box with antistatic pouch in room temperature to avoid dusts and sunlight, when storing the product.
- ② In order to prevent dew condensation occurred by temperature difference, the product packing box must be opened after enough time being left under the environment of an unpacking room. Evaluate the storage time sufficiently because dew condensation is affected by the environmental temperature and humidity. (Recommended leaving time: 6 hours or more with the original packing state after a customer receives the package)
- ③ Do not operate in high magnetic field. If not, circuit boards may be broken.
- ④ This product is not designed as radiation hardened.

PRELIMINARY

NLT Technologies, Ltd.

NL160120AC27-32

7.3.3 Characteristics

The following items are neither defects nor failures.

- ① Response time, luminance and color may be changed by ambient temperature.
- ② Display mura, flickering, vertical streams or tiny spots may be observed depending on display patterns.
- ③ Do not display the fixed pattern for a long time because it may cause image sticking. Use a screen saver, if the fixed pattern is displayed on the screen. 2
- ④ The display color may be changed depending on viewing angle because of the use of condenser sheet in the backlight.
- ⑤ Optical characteristics may be changed depending on input signal timings.

7.3.4 Others

- ① All GND, GNDB, VDD and VDDB terminals should be used without any non-connected lines.
- ② Do not disassemble a product or adjust variable resistors.
- ③ Pack the product with the original shipping package, in order to avoid any damages during transportation, when returning the product to NLT for repairing and so on.
- ④ The LCD module by itself or integrated into end product should be packed and transported with display in the vertical position. Otherwise the display characteristics may be degraded.



2

2

2

2

PRELIMINARY

NLT Technologies, Ltd.

NL160120AC27-32

8. OUTLINE DRAWINGS
8.1 FRONT VIEW

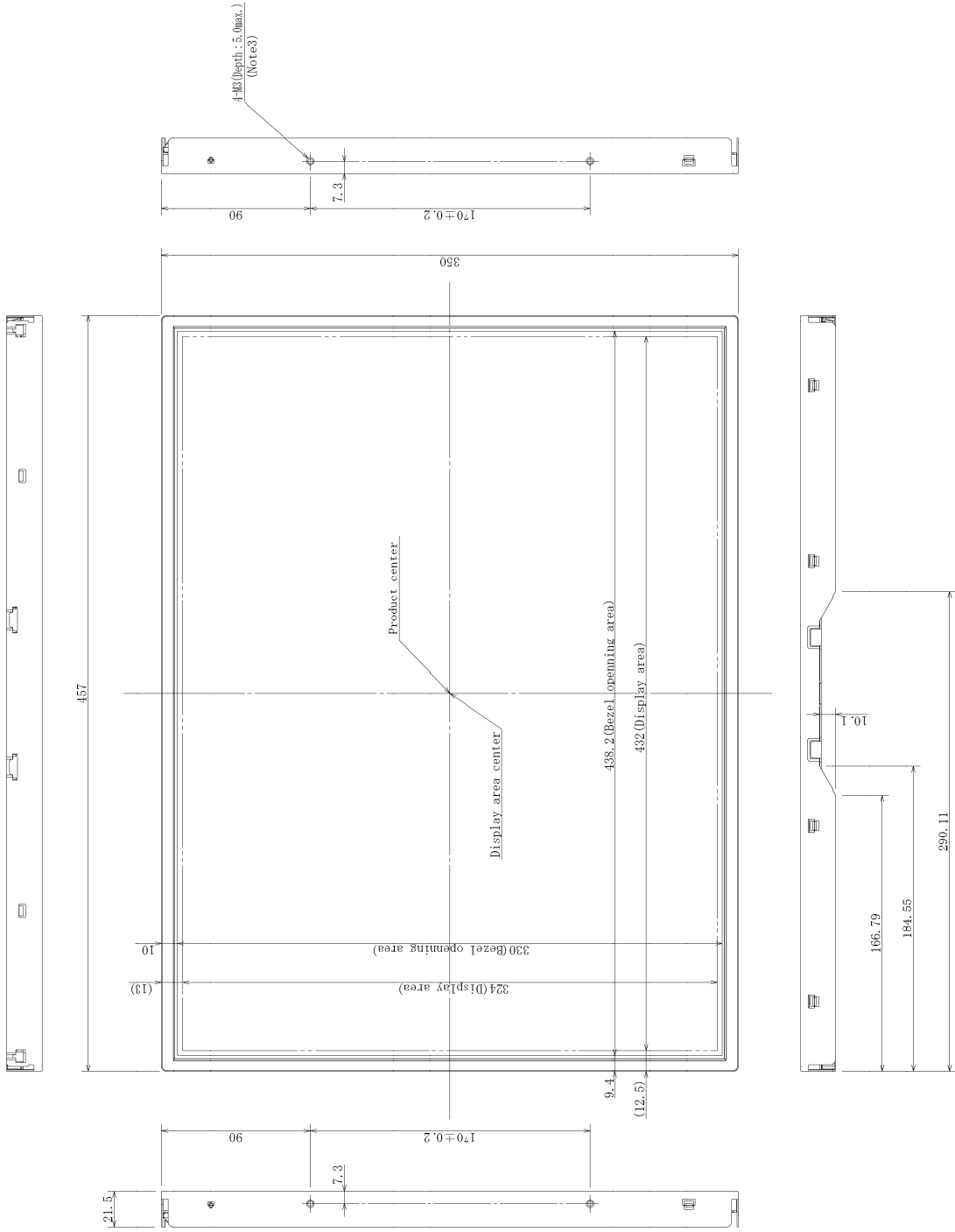

Note1: Not shown tolerances of the dimensions are ±0.5mm.

Note2: The torque for product mounting screws must never exceed 0.735N·m.

Note3: The length of product mounting screws from surface of plate must be ≤ 5.0mm.

Note4: The values in parentheses are for reference.

Unit: mm

PRELIMINARY

NLT Technologies, Ltd.

NL160120AC27-32

8.2 REAR VIEW

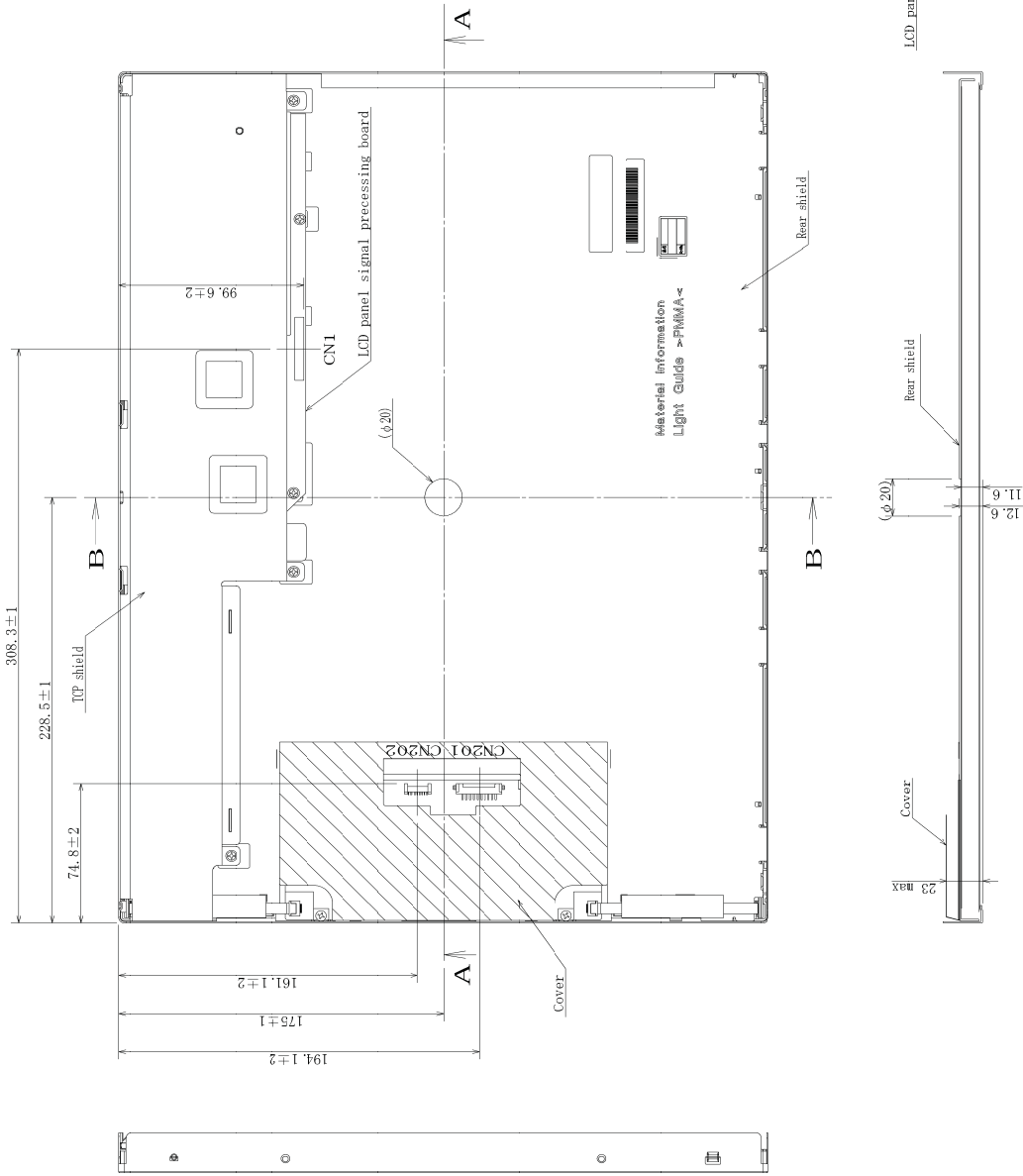

- Note 1: Not shown tolerances of the dimensions are $\pm 0.5\text{mm}$.
 Note 2: The torque for product mounting screws must never exceed $0.735\text{N}\cdot\text{m}$.
 Note 3: The length of product mounting screws from surface of plate must be $\leq 5.0\text{mm}$.
 Note 4: The values in parentheses are for reference.

Unit: mm

PRELIMINARY

NLT Technologies, Ltd.

NL160120AC27-32

REVISION HISTORY

The inside of latest specifications is revised to the clerical error and the major improvement of previous edition. Only a changed part such as functions, characteristic value and so on that may affect a design of customers, are described especially below.

Edition	Document number	Prepared date	Revision contents and signature
1st edition	DOD-PP-1244	July 8, 2011	<p>Revision contents</p> <p>New issue</p> <p>Writer</p> <p>Approved by _____ T. OGAWA</p> <p>Checked by _____</p> <p>Prepared by _____ T. OGAWA</p>
2nd edition	DOD-PP-1268	Sep 16, 2011	<p>Revision contents</p> <p>P5 General specifications</p> <ul style="list-style-type: none"> • Luminance: 890 cd/m² (typ.) → 900 cd/m² (typ.) • Signal system: THC63LVD824 → THC63LVD824A • Power consumption: (52) W (typ.) → (57) W (typ.) <p>P7 Mechanical specifications</p> <ul style="list-style-type: none"> • Module size: TBD (max. D) mm → 23.0 (max. D) mm • Weight: TBD (max.) g → (2,980) (max.) g <p>P7 Absolute maximum ratings</p> <ul style="list-style-type: none"> • Power supply voltage- LED driver board: -0.3 to +27.0 V → -0.3 to +15.0 V • Operating temperature- Rear surface: (0 to + TBD) °C → (0 to + 60) °C <p>P8 LCD panel signal processing board</p> <ul style="list-style-type: none"> • Power supply current: TBD (max.) mA → (700) (max.) mA <p>P9 LED Driver board</p> <ul style="list-style-type: none"> • Power supply current: (5,000) (typ.) mA → (4,200) (typ.) mA <p>P9 LED Driver board current wave</p> <ul style="list-style-type: none"> • (5,000) mA (typ.) → (4,200) mA (typ.) • At the minimum luminance control: TBD % → (1) % (At frequency: 325 Hz) <p>P10 Power supply voltage ripple (addition), Fuse (addition)</p> <p>P11 LED Driver board</p> <ul style="list-style-type: none"> • tr ≤ TBD ms → tr ≤ (100) ms • Note2: TBD → (100) ms <p>P15 Luminance control methods</p> <ul style="list-style-type: none"> • Variable resistor control- Luminance ratio: 0Ω: TBD % → 0 % • Voltage control- Luminance ratio: 0V: TBD % → 0 % • Pulse width modulation- Luminance ratio : TBD, TBD % → (0.01), (1) %, (At frequency: 325 Hz) • Note4: "4.6.3 Detail of BRTP timing" → "4.6.2 Detail of BRTP timing" <p>P16 Detail of BRTP timing- Each parameter</p> <ul style="list-style-type: none"> • Luminance control frequency: (325) (max.) Hz → (1,000) (max.) Hz • Parameter: Duty ratio → External PWM pulse width <p>P17 LVDS data input map- Mode A</p> <ul style="list-style-type: none"> • Transmitter: THC63LVDF83A → THC63LVDM83D, THC63LVD823 → THC63LVD823B <p>P24-25 Optical characteristics</p> <ul style="list-style-type: none"> • Luminance: 890 cd/m² (typ.) → 900 cd/m² (typ.) • Color uniformity (addition) • Response time: Ton / Toff: TBD (max.) ms → (30) (max.) ms • Viewing angle- Measuring instrument: BM-5A (addition) • Note3: TopF = TBD°C → TopF = 32°C • Note4: TopF = TBD°C → TopF = 30°C Temperature difference in display area: ΔTBD°C (addition) • Note7 (addition) • Definition of color uniformity (addition)

PRELIMINARY

NLT Technologies, Ltd.

NL160120AC27-32

REVISION HISTORY

Edition	Document number	Prepared date	Revision contents and signature
2nd edition	DOD-PP-1268	Sep 16, 2011	<p>Revision contents</p> <p>P30 Characteristics</p> <ul style="list-style-type: none"> • Optical characteristics ..., because the LCD has cold cathode fluorescent lamps. (elimination) <p>P31-32 Outline drawings- Front view</p> <ul style="list-style-type: none"> • Front view <ul style="list-style-type: none"> • 7.5 → 7.3 (2 points), 8.9 → 10.1 • Display center → Product center • 92, 122.3 (elimination) • 166.79, 184.55, 290.11 (additon) • Rear view • Cover: figure is changed. <p>Signature of writer</p> <p>Approved by <i>T. Ogawa</i> Checked by _____ Prepared by <i>T. Ogawa</i></p> <p>_____ _____ _____</p> <p>T. OGAWA T. OGAWA T. OGAWA</p>