

# TFT COLOR LCD MODULE

## NL160120AC27-01A

**54 cm (21.3 inches), 1600 1200 pixels,  
Full-color, Multi-scan function,  
Ultra-wide viewing angle**

### DESCRIPTION

NL160120AC27-01A is a TFT (thin film transistor) active matrix color liquid crystal display (LCD) comprising amorphous silicon TFT attached to each signal electrode, a driving circuit, a CRT interface board and a backlight. NL160120AC27-01A has a built-in backlight with an inverter.

The 54 cm (21.3 inches) diagonal display area contains 1600 1200 pixels and can display full-color (more than 16 million colors simultaneously). Also, it has ultra wide viewing angle and multi-scan function. Therefore, this module calls Super Fine TFT.

### FEATURES

- Ultra-wide viewing angle and low reflection
- High luminance
- CRT interface board
- Auto recognition of input signal  
Analog RGB signals, Sync on Green, Synchronous signals (HS, Vsyn. Composite)
- Digital control: e.g. Brightness, Display Position
- Free supply voltage sequence
- Corresponding to DDC1 and DDC2B
- Corresponding to VESA DPMS
- Multi-scan function: e.g. UXGA, SXGA, XGA, SVGA, VGA, VGA-TEXT, PC-9801, MAC, SUN
- Incorporated backlight (12 lamps into a lamp unit, Inverter)
- Lamp unit replaceable (Part No.: 213LHS01)
- UL1950 3rd ed. UL/CSA-C22.2 No.950-95 (Pending)
- On Screen Display  
Regarding the use of OSD, please note that there is possibility of conflicts with a patent in Europe and the U.S.  
Thus, if such conflict might happen when you use OSD, we shall not be responsible for any trouble.

VESA : Video Electronics Standards Association  
DPMS : Display Power Management Signaling  
DDC1 : Display Data Channel 1  
DDC2B: Display Data Channel 2B

### APPLICATIONS

- Engineering workstation (EWS), Desk-top type of PC
- Display terminals for control system
- Monitors for process controller



**STRUCTURE AND FUNCTIONS**

A color TFT (thin film transistor) LCD module is comprised of a TFT liquid crystal panel structure, LSIs for driving the TFT array, and a backlight assembly. The TFT panel structure is created by sandwiching liquid crystal material in the narrow gap between a TFT array glass substrate and a color filter glass substrate. After the driver LSIs are connected to the panel, the backlight assembly is attached to the backside of the panel.

RGB (red, green, blue) data signals from a source system is modulated into a form suitable for active matrix addressing by the onboard signal processor and sent to the driver LSIs which in turn addresses the individual TFT cells.

Acting as an electro-optical switch, each TFT cell regulates light transmission from the backlight assembly when activated by the data source. By regulating the amount of light passing through the array of red, green, and blue dots, color images are created with clarity.

**OUTLINE OF CHARACTERISTICS (at room temperature)**

Display area	432.0 (H) 324.0 (V) mm
Drive system	a-Si TFT active matrix
Display colors	Full-color
Number of pixels	1600 1200
Pixel arrangement	RGB vertical stripe
Pixel pitch	0.270 (H) 0.270 (V) mm
Module size	470.0 (H) 382.0 (V) 41.6 (D) mm (typ.)
Weight	3050 g (typ.)
Contrast ratio	250:1 (typ.)
Viewing angle (more than the contrast ratio of 10:1)	<ul style="list-style-type: none"> <li>• Horizontal: 85° (typ., left side, right side)</li> <li>• Vertical : 85° (typ., up side, down side)</li> </ul>
Designed viewing direction	<ul style="list-style-type: none"> <li>• Optimum grayscale ( = 2.2): perpendicular</li> </ul>
Color gamut	60% (typ., At center, To NTSC)
Response time	20 ms (typ.), "black" to "white"
Luminance	200 cd/m <sup>2</sup> (typ.)
Input signals	Analog RGB signals, Synchronous signals (Vsync and Hsync or Composite), Digital data
Backlight	Direct type: 12 cold cathode fluorescent lamps with an inverter <Replacement parts> Inverter                      Parts No.: 213PW011 Lamp holder set              Parts No.: 213LHS01
Supply voltage	12 V, 12 V (Logic/LCD driving, Backlight)
Power consumption	71 W (typ.)

**BLOCK DIAGRAM**

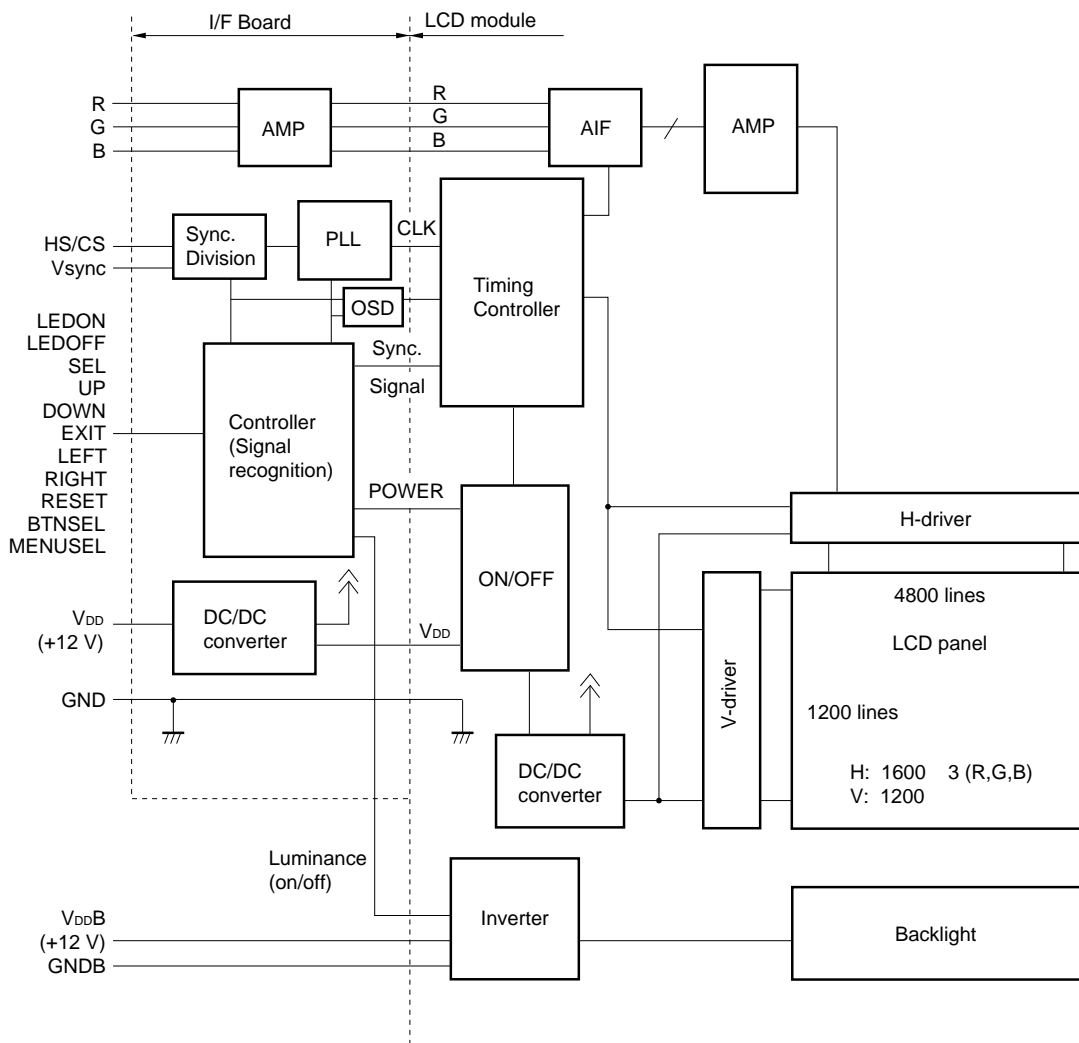

**Note** Frame Ground and GND are connected in this module.  
GNDB is not connected to Frame Ground.

**SPECIFICATIONS**

**GENERAL SPECIFICATIONS**

Item	Contents	Unit
Module size	470.0 ± 1.0 (H) 382.0 ± 1.0 (V) 42.5 (max.) (D)	mm
Display area	432.0 (H) 324.0 (V)	mm
Number of dots	1600 3 (H) 1200 (V)	dots
Pixel pitch	0.270 (H) 0.270 (V)	mm
Dot pitch	0.090 (H) 0.270 (V)	mm
Pixel arrangement	RGB (Red, Green, Blue) vertical stripe	–
Display colors	Full color	color
Weight	3150 (max.)	g

**ABSOLUTE MAXIMUM RATINGS**

Parameter	Symbol	Rating	Unit	Remarks
Supply voltage	V <sub>DD</sub>	–0.3 to + 14	V	T <sub>a</sub> = 25°C
	V <sub>DDB</sub>	–0.3 to + 14	V	
Logic input voltage	V <sub>In1</sub>	–0.3 to + 5.5	V	T <sub>a</sub> = 25°C V <sub>DD</sub> = 12 V
R,G,B input voltage	V <sub>In2</sub>	–6.0 to + 6.0	V	
CLK input voltage	V <sub>In3</sub>	–7.0 to + 7.0	V	
Storage temp.	T <sub>st</sub>	–20 to + 60	°C	–
Operating temp.	Top	0 to 50	°C	Module surface <b>Note</b>
Humidity (no condensation)	95% relative humidity		T <sub>a</sub> 40°C	
	85% relative humidity		40 < T <sub>a</sub> 50°C	
	Absolute humidity shall not exceed T <sub>a</sub> = 50°C, 85 % relative humidity) level.		T <sub>a</sub> > 50°C	

**Note:** Measure at panel center (Including self heat)

**ELECTRICAL CHARACTERISTICS**

**(1) Logic, LCD driving, Backlight**

(T<sub>a</sub> = 25°C)

Item	Symbol	Min.	Typ.	Max.	Unit	Remarks
Supply voltage	V <sub>DD</sub>	10.8	12.0	13.2	V	Logic and LCD driving
	V <sub>DDB</sub>	11.4	12.0	13.2	V	Backlight
Logic input "L" voltage	V <sub>IL</sub>	10.8	–	0.8	V	HS/CS, Vsync, UP, DOWN, SEL, RESET, EXIT, RIGHT, LEFT, DDCCLK, DDCDAT
Logic input "H" voltage	V <sub>IH</sub>	2.2	–	5.25	V	
Logic output "L" voltage	V <sub>oL1</sub>	–	–	0.4		DDCAT
Logic output "H" voltage	V <sub>oH1</sub>	2.4	–	–	V	
Logic input "L" current	I <sub>IL</sub>	–1	–	–	A	HS/CS, Vsync
Logic input "H" current	I <sub>IH</sub>	–	–	1	A	
Supply current	I <sub>DD</sub>	–	1700 <small>Note1</small>	2200 <small>Note2</small>	mA	V <sub>DD</sub> = 1 2.0 V
		–	–	70 <small>Note2</small>	mA	Power saving mode V <sub>DD</sub> = 1 2.0 V
	I <sub>DDB</sub>	–	4200	5000	mA	V <sub>DDB</sub> = 12.0 V (Max. luminance)
		–	–	10	mA	Power saving mode V <sub>DDB</sub> = 12.0 V

- Notes**
1. Checker flag pattern (in EIAJ ED-2522)
  2. Pixel checkered pattern

**(2) Video signal (R, G, B) input**

(T<sub>a</sub> = 25°C)

Item	Min.	Typ.	Max.	Unit	Remarks
Maximum amplitude (white - black)	0 (black)	0.7 (white)	*A	Vp-p	<b>Note</b>
DC input level (black)	0.5	–	+2.5	V	–
Sync level	0.2	0.3	*B	Vp-p	G terminal (sync on green)
*A + *B	–	–	1.1	Vp-p	–

**Note** Contrast adjustment is needed if the amplitude exceeds 0.7 Vp-p.

**POWER SUPPLY DESIGN**

- (1) 12 V for backlight should be started up within 80 ms, otherwise, the protection circuit makes the backlight turns off.
- (2) If the power supply voltage is applied while UP and DOWN are connected to GND, the input control signals become ineffective mode. To reset this mode, turn off the power once and turn on the power while UP and DOWN are connected to GND. Then, the mode will be released.
- (3) Inverter current wave  
Inverter current wave is as follows.

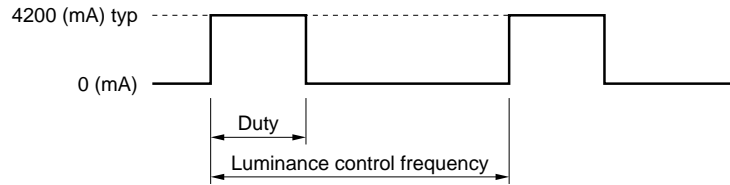

Maximum luminance control: 100 %  
 Minimum luminance control: 30 %  
 Luminance control frequency = Input Vsync frequency / K  
 Input Vsync frequency = 75 Hz: K = 4.6  
 Input Vsync frequency > 75 Hz: K = 3.6

- (4) Ripple of supply voltage  
Please note that the ripple at the input connector of the module should be within the values shown in this table. If the ripple is beyond these values, the noise may appear on the screen.

	V <sub>DD</sub> (for logic and LCD driver)	V <sub>DD</sub> B (for backlight)
Acceptable range	100 mVp-p	200 mVp-p

**Note** The acceptable range of ripple voltage includes spike noise.

Example of the power supply connection

a) Separate the power supply

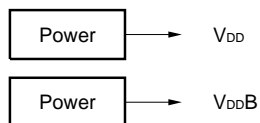

b) Put the filter

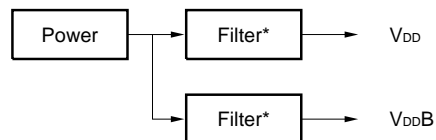

**INTERFACE**  
**INTERFACE CONNECTION**

(1) CN101

Part No. : MRF03-6R-SMT  
 Adaptable socket: MRF03-2 6P-1.27 (For cable type) or MRF03-6PR-SMT (For board to board type)  
 Supplier : HIROSE ELECTRIC CO., LTD. (coaxial type)

Coaxial cable : UL20537PF75VLAS  
 Supplier : HITACHI CO., LTD.

**Note** A coaxial cable shield should be connected with GND.

Pin No.	Symbol	Pin No.	Symbol
1	B	4	Vsync
2	G	5	HS/CS
3	R	6▼	N.C.

**Note** N.C. (No connection) should be open.

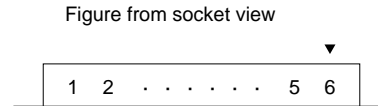

(2) CN102

Part No. : IL-Z-4PL-SMTY  
 Adaptable socket: IL-Z-4S-S125C3  
 Supplier : Japan Aviation Electronics Industry Limited (JAE)

Pin No.	Symbol	Pin No.	Symbol
1	DDCCLK	3	MENUSEL
2	DDCDAT	4	GND

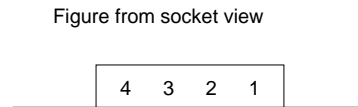

(3) CN103

Part No. : DF14A-25P-1.25H  
 Adaptable socket: DF14-25S-1.25C  
 Supplier : HIROSE ELECTRIC CO., LTD.

Pin No.	Symbol	Pin No.	Symbol
1	LEDON	14	EXIT
2	LEDOFF	15	GND
3	GND	16	N.C.
4	N.C.	17	GND
5	N.C.	18	TEST1
6	RIGHT	19	BTNSEL
7	LEFT	20	N.C.
8	RESET	21	N.C.
9	N.C.	22	N.C.
10	GND	23	GND
11	SEL	24	N.C.
12	UP	25	N.C.
13	DOWN		

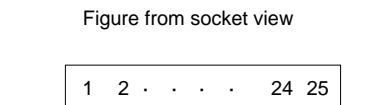

**Note** N.C. (No connection) should be open.  
 TEST1 should be grounded.

(4) CN104

Part No. : IL-Z-8PL-SMTY  
 Adaptable socket: IL-Z-8S-S125C3  
 Supplier : Japan Aviation Electronics Industry Limited (JAE)

Pin No.	Symbol	Pin No.	Symbol
1	V <sub>DD</sub>	5	GND
2	V <sub>DD</sub>	6	GND
3	V <sub>DD</sub>	7	GND
4	V <sub>DD</sub>	8	GND

Figure from socket view

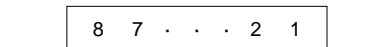

(5) CN201

Part No. : DF3-8P-2H  
 Adaptable socket: DF3-8S-2C  
 Supplier : HIROSE ELECTRIC CO., LTD.

Pin No.	Symbol	Pin No.	Symbol
1	GNDB	5	V <sub>DD</sub> B
2	GNDB	6	V <sub>DD</sub> B
3	GNDB	7	V <sub>DD</sub> B
4	GNDB	8▼	V <sub>DD</sub> B

Figure from socket view

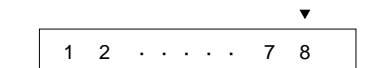

Rear view

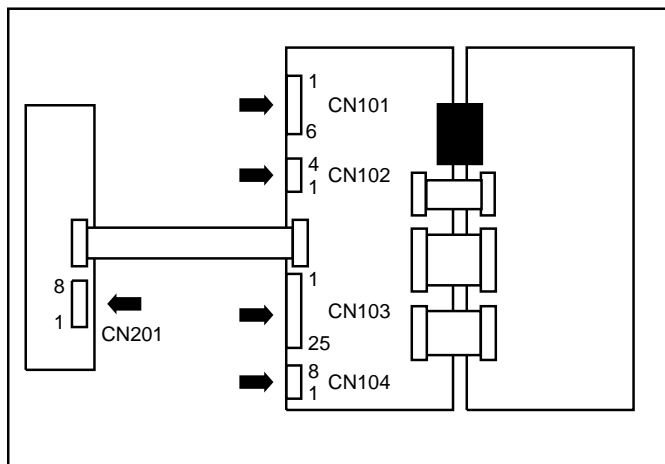



## PIN FUNCTION

Symbol	I/O	Logic	Description
HS/CS	Input	Negative	Horizontal synchronous signal input or composite synchronous signal input (TTL level), Positive/Negative auto recognition
Vsync	Input	Negative	Vertical synchronous signal input (TTL level) Positive/Negative auto recognition, Clock input for DDC1
R	Input	–	Red video signal input (0.7 Vp-p, input impedance 75 Ω)
G	Input	–	Green video signal input (0.7 Vp-p, input impedance 75 Ω)
B	Input	–	Blue video signal input (0.7 Vp-p, input impedance 75 Ω)
SEL	Input	Negative	Control function select signal (TTL level) SEL is pulled up in the module. Detail of the functions are mentioned in <b>CONTROL FUNCTIONS</b> . "H" or "open": SEL off, "L": SEL on
UP	Input	Negative	Control signal (TTL level) The signal increases the value of the functions selected. UP is pulled up in the module. "H" or "open": UP off, "L": UP on
DOWN	Input	Negative	Control signal (TTL level) The signal decreases the value of the functions selected. DOWN is pulled up in the module. "H" or "open": DOWN off, "L": DOWN on
EXIT	Input	Negative	Control signal (TTL level) The signal initializes the selected function. EXIT is pulled up in the module. "H" or open": EXIT off, "L": EXIT on
RIGHT	Input	Negative	Control signal (TTL level) This signal increase the value or shift the position to right. This input is valid only in case of 7SW mode. It is pulled up in the module
LEFT	Input	Negative	Control signal (TTL level) This signal decrease the value or shift the position to left. This input is valid only in case of 7SW mode. It is pulled up in the module
RESET	Input	Negative	Control signal (TTL level) This signal resets the value or the position. This input is valid only in case of 7SW mode. It is pulled up in the module
DDCCLK	Input	Positive	CLK for DDC2B
DDCDAT	Input/Output	Positive	Data for DDC1/2B, read/write
LEDON	Output	Positive	Indicator for LED power on "H": normal mode select, "L": Other status
LEDOFF	Output	Positive	Indicator for power save mode "H": power save mode select, "L": Other status
BTNSEL	Input	–	Select signal for Adjustment Switches. Refer to ADJUSTMENT SWITCH (SW) SELECT. It is pulled up in the module.
TEST1	Input	–	This is for internal test purpose. It should be grounded(GND) It is pulled up in the module.
MENUSEL	Input	–	Select signal of OSD design. Refer <b>OSD DESIGN SELECT</b>
V <sub>DD</sub>	–	–	Power supply for Logic and LCD driving +12V (+/- 10%)
V <sub>DDB</sub>	–	–	Power supply for backlight +12V (+/- 10%)
GND	–	–	Ground for logic and LCD driving (VDD)
GNDB	–	–	Ground for backlight (V <sub>DDB</sub> )

- Notes** 1: Frame Ground (FG) and GND are connected in the module. GNDB is not connected in this module.  
 2: 12 V for backlight should be started up within 80 ms, otherwise, the protection circuit makes the backlight turns off.

**ADJSTMENT SWITCH (SW) SELECT**

BTNSEL	"L"	"Open" (Pull-up internally)
Adjustment SW	4 SW	7SW
Functions & Operation	Same as conventional operation.	Operation is more easier than 4SW

**OSD DESIGN SELECT**

MENUSEL	"L"	"Open" (Pull-up internally)
OSD	OSD without background	OSD with background
Functions & Operation	OSD background is transparent.	OSD background is blue.

**EQUIVALENT CIRCUIT FOR LED**

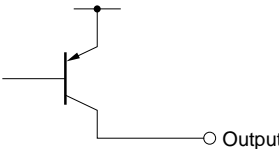
Symbol	I/O	Equivalent circuit
LEDON LEDOFF	Output	RN2306 (Toshiba) or Equivalents 

**<Example of LED circuit>**

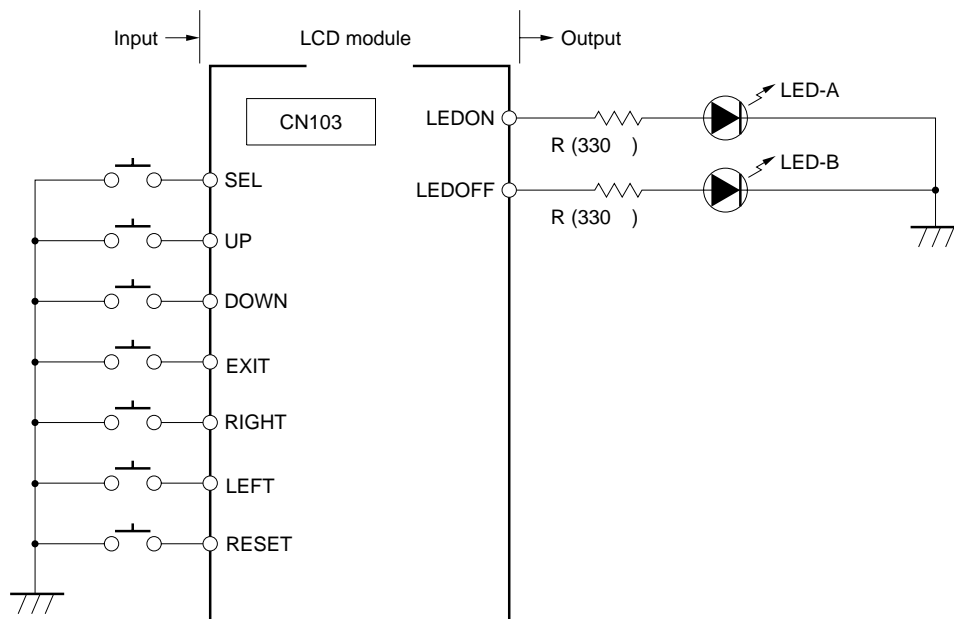

**INPUT SYNCHRONOUS SIGNAL**

This module is corresponding to the synchronous signals below.

Auto recognition mode	Synchronous signal		
	HS/CS	Vsync	Sync. On Green
Separate synchronous signal mode (Hsync, Vsync)	Input	Input	Input or no input
Composite synchronous signal mode	Input (CS)	No input	Input or no input
Sync. On Green mode	No input	No input	Input
Power save mode	No input	No input	No input
	No input	Input	Input or no input
	Input (HS)	No input	Input or no input

**Note** Power save mode corresponds to VESA DPMA.

## PRESET TIMING

The 21 types of display timing shown below are preset in this module. When the timing signals in this table are input, the device automatically assesses display timing and controls the display using the preset value.

No.	Display resolution (dots)	Vsync (Hz)	Hsync (kHz)	DOTCLK (MHz)	V Pulse (H)	V B.porch (V)	H Pulse (DOTCLK)	H B.porch (DOTCLK)	Sync Logic V, H	Remarks
1	640 400	56.432	24.830	21.053	8	25	96	48	-, -	NEC PC98
2	640 480	59.992	31.469	25.175	2	33	96	48	-, -	VGA
3	720 400	70.087	31.469	28.322	2	35	108	45	+, -	VGA TXT
4	800 600	60.317	37.879	40.000	4	23	128	88	+, +	VESA
5	640 480	66.667	35.000	30.240	3	39	64	96	SonG type A	Macintosh
6	640 480	75.000	37.500	31.500	3	16	64	120	-, -	VESA
7	720 400	85.039	37.927	35.500	3	42	36	144	+, -	VESA <sup>Note</sup>
8	640 480	85.008	43.269	36.000	3	25	48	112	-, -	VESA <sup>Note</sup>
9	1024 768	60.004	48.363	65.000	6	29	136	160	-, -	VESA
10	800 600	75.000	46.875	49.500	3	21	80	160	+, +	VESA
11	832 624	74.565	49.735	57.283	3	39	64	224	SonG type A	Macintosh
12	800 600	85.061	53.674	56.250	3	27	64	152	+, +	VESA <sup>Note</sup>
13	1024 768	70.069	56.476	75.000	6	29	136	144	-, -	VESA
14	1024 768	75.029	60.023	78.750	3	28	96	176	-, -	VESA
15	1280 1024	60.020	63.981	108.000	3	38	112	248	+, +	VESA
16	1152 900	66.003	61.846	94.500	4	31	128	208	CS(-)	SUN <sup>Note</sup>
17	1024 768	77.068	62.040	84.375	4	31	128	176	CS(-)	SUN <sup>Note</sup>
18	1280 1024	67.189	71.691	117.000	8	33	112	224	CS(-)	SUN
19	1152 900	76.149	71.809	108.000	8	33	128	192	CS(-)	SUN <sup>Note</sup>
20	1280 1024	75.025	79.976	135.000	3	38	144	248	+, +	VESA
21	1600 x 1200	60.000	75.000	162.000	3	46	192	304	+, +	VESA

\* These preset timings are not included in the specifications of the LCD module. Use preset timing only after careful evaluation.

**Note 1.** Please bear in mind slight adjustment (multiplication value, clock delay, and display location) is required as a result of equipment variation even if input is performed with the display timing of this table.

Readjustment, however, is unnecessary because adjusted values are stored in memory for every preset number.

Display is controlled with preset timing near HS and Vsync frequency even if a signal with a timing other than the preset display timing is input.

2. The device may not function normally if a signal is input that differs from the timing shown in the above table by a large margin. In addition, the device will not operate normally if waveforms are distorted by rounding of Hsync or Vsync waveforms, noise, and others factors, even for a signal with the same timing as shown above.

**Example** For 640 480 dots, HS: 37.861 kHz, and Vsync: 72.809 Hz, the image is displayed with preset number 6. Adjustment may not be synchronized if the expansion rate (scaling factor) or other values differ when the device is used with a display timing other than a preset one. Therefore, only use a non-preset display timing after careful evaluation.

3. Display colors may change during Sync on Green (SonG) input.
4. SonG signal types:

**(1) SonG type A**

An equivalent Hsync pulse is not present during Vsync period.

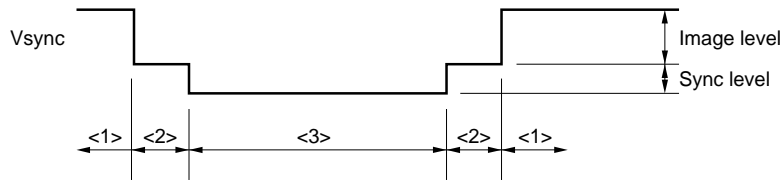

**(2) SonG type B**

An equivalent Hsync pulse is present during Vsync period.

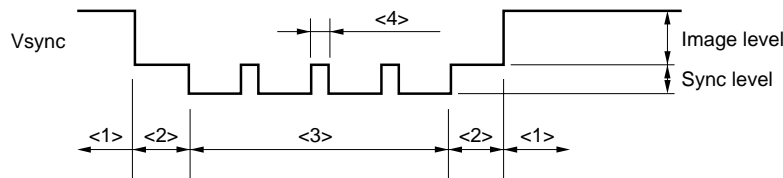

- <1> Image signal
- <2> Black level period
- <3> Vsync period
- <4> Hsync equivalent pulse

**EXPANSION FUNCTION**

**HOW TO USE EXPANSION MODES**

Expansion mode is a function to expand screen. For example, VGA signal has 640 480 pixels. But, if the display data can be expanded to 2.5 times vertically and horizontally, VGA screen image can be displayed fully on the screen of SXGA resolution.

This LCD module has the function that expands vertical and horizontal directions as shown in Table below.

Please adopt this mode after evaluating display quality, because the appearance in expansion mode is happened to be relatively bad in some cases.

The followings show display magnifications for each mode.

Input display	Number of pixels	Magnification	
		Vertical	Horizontal
UXGA	1600 x 1200	1.0	1.0
SXGA	1280 1024	1.17	1.25
SUN	1152 x 900	1.38	1.33
XGA	1024 768	1.56	1.56
SVGA	800 600	2.0	2.0
VGA	640 480	2.5	2.5
VGA text	720 400	3.0	2.2
PC9801	640 400	3.0	2.5
MAC	832 624	1.92	1.92

**DDC FUNCTION**

This function is corresponding to VESA DDC™ and EDID™ (Structure Version 1).

This LCD module uses Microchip 24LC21 memory for writing DDC's data. When you use this function, please refer to the data sheet of this memory chip.

EDID: Extended Display Identification Data

**<Internal equivalent circuit diagram>**

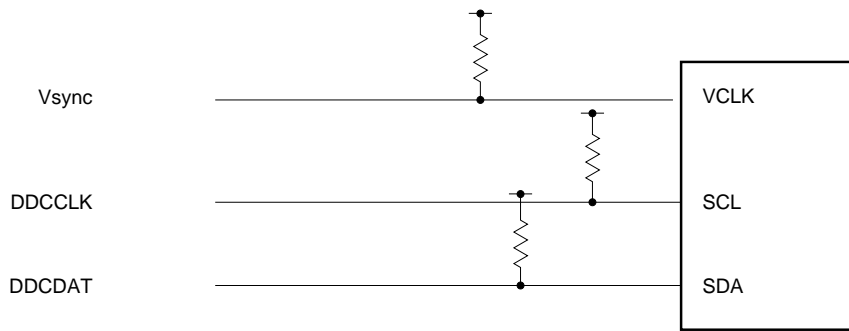

Product: Microchip Technology Inc.  
24LC21  
or equipment

Please write a data into necessary addresses when you will use this function.  
For our inspection purpose, data ""55" was written at address "00" and other addresses were "FF" at factory set.

**DPMS**

This function is corresponding to VESA DPMS™ Standard.

VESA DPMS Standard					NL160120AC27-01A		
State	Signal			Power saving	Recovery time	Power saving	Recovery time
	Horizontal	Vertical	Video				
On	Pulses	Pulses	Active	None	Not applicable	None	Not applicable
Stand-by	No pulses	Pulses	Blanked	Minimum	Short	Maximum	Short
Suspend	Pulses	No pulses	Blanked	Substantial	Longer	Maximum	Short
Off	No pulses	No pulses	Blanked	Maximum	System dependent	Maximum	Short

**CONTROL FUNCTIONS**

**FUNCTION ITEMS**

The input video signals to this LCD module can be adjusted by SEL/UP/DOWN/LEFT/RIGHT/RESET/EXIT signals. The following table shows which functions can be controlled by these signals. The control functions are different by selecting adjustable SW.

Controllable Items	Functions
Auto Adjust	Auto adjustment. The following Clock and Position can be adjusted automatically.
Brightness	Brightness control of backlight. The brightness can be changed.
Clock	Adjust the horizontal size (H. Size) Adjust the dot clock frequency to comply to the input video signals. Clock delay adjustment (Clock Phase) Adjust the dot clock phase to the input video signals.
Position	Adjust the horizontal position (H. Position) Adjust the display position horizontally. Adjust the vertical position (V. Position) Adjust the display position vertically.
Contrast	Adjustment of contrast Adjust the contrast depending on the input video signals. Adjust the contrast of RGB colors individually or simultaneously. However, depending on the initial set, the individual adjustment is not available.
Color Level	Adjustment of color level Adjust the black level depending on the input video signals. Adjust the black level of RGB colors individually or simultaneously. However, depending on the initial set, the individual adjustment is not available.
Information	Information of input video signals Display of resolutions and frequencies of Hsync and Vsync.
OSD Position	Adjust the display position of OSD Change the display position of OSD at center, left upper corner, right upper corner, left bottom corner and right bottom corner.
All Reset	All reset Initialize the all above adjustment values except Information. Reset to the initial values set by the initialized function or default value when it was shipped from factory.

Each adjusted value is memorized in the LCD module every display modes and every preset timing, therefore, it is not necessary to see up the values every time when the power is turned on. However, adjusted values are not memorized in case of that the adjustment mode is changed during the set of value or the power is turned off.

Auto Adjust is affected by the system PCs and display modes. In this case, manual adjustment is required.

In case of input signals are different from the preset timing, Information shows you a different resolution.

The adjustment ranges of Position are deviated when OSD Position is changed. Therefore, the display position might be affected.

The display is momentarily disturbed during adjustment.

Auto Adjust does not function correctly when both Sync on Green and separate sync signals are input. In this case, manual adjustment is required.



FLOW CHART OF CONTROL FUNCTIONS AND OSD IMAGES

< 4SW mode >

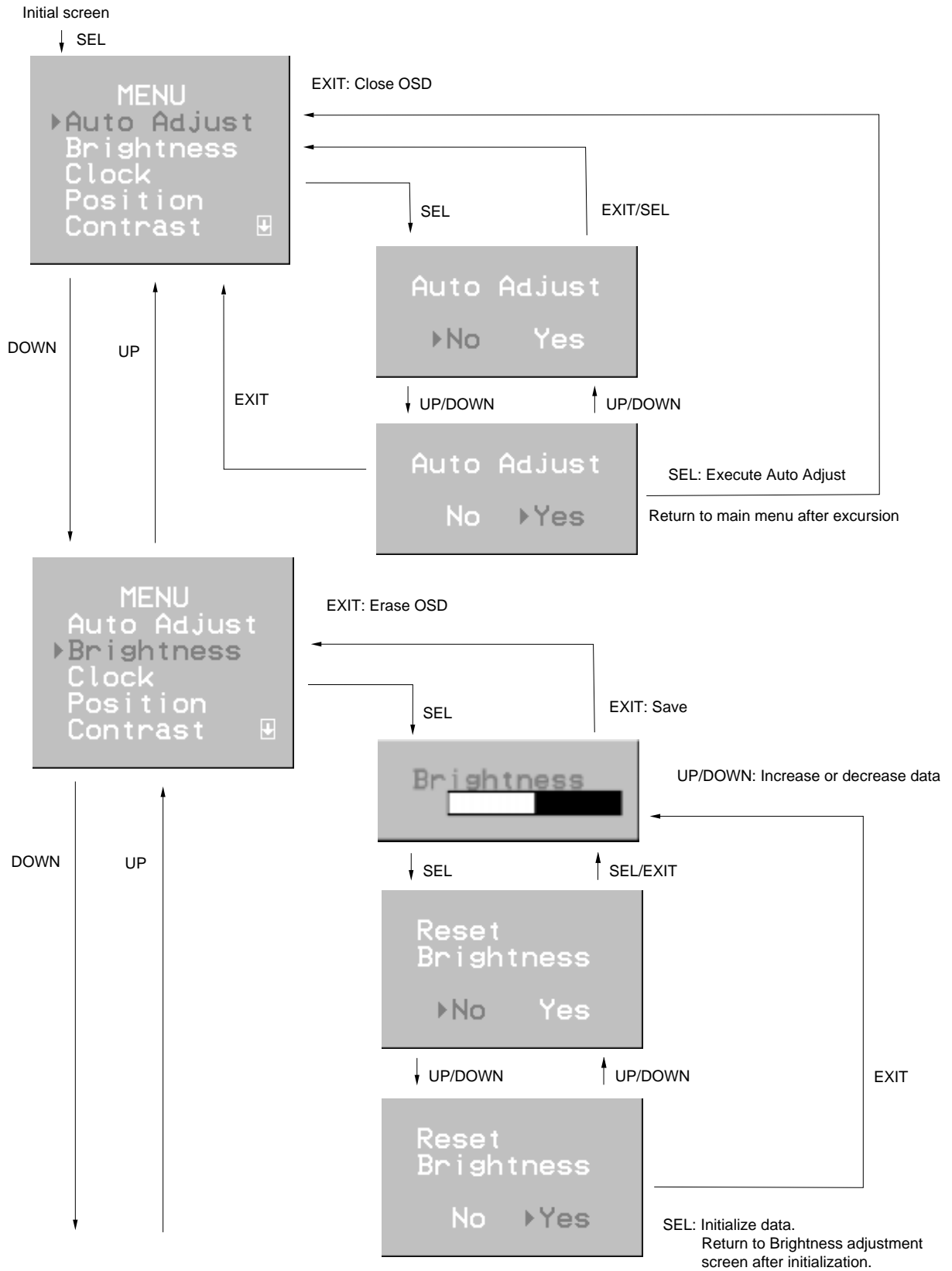

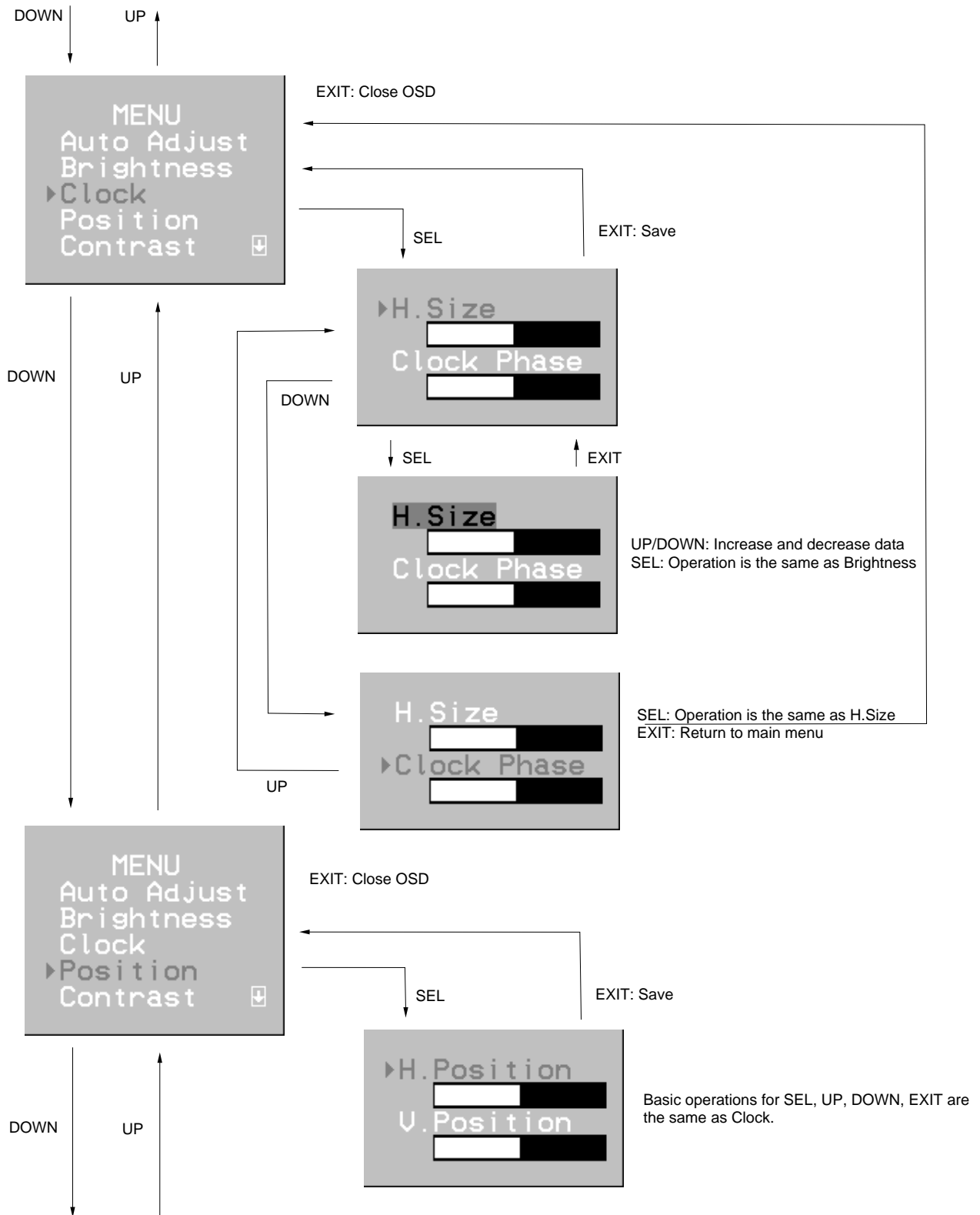

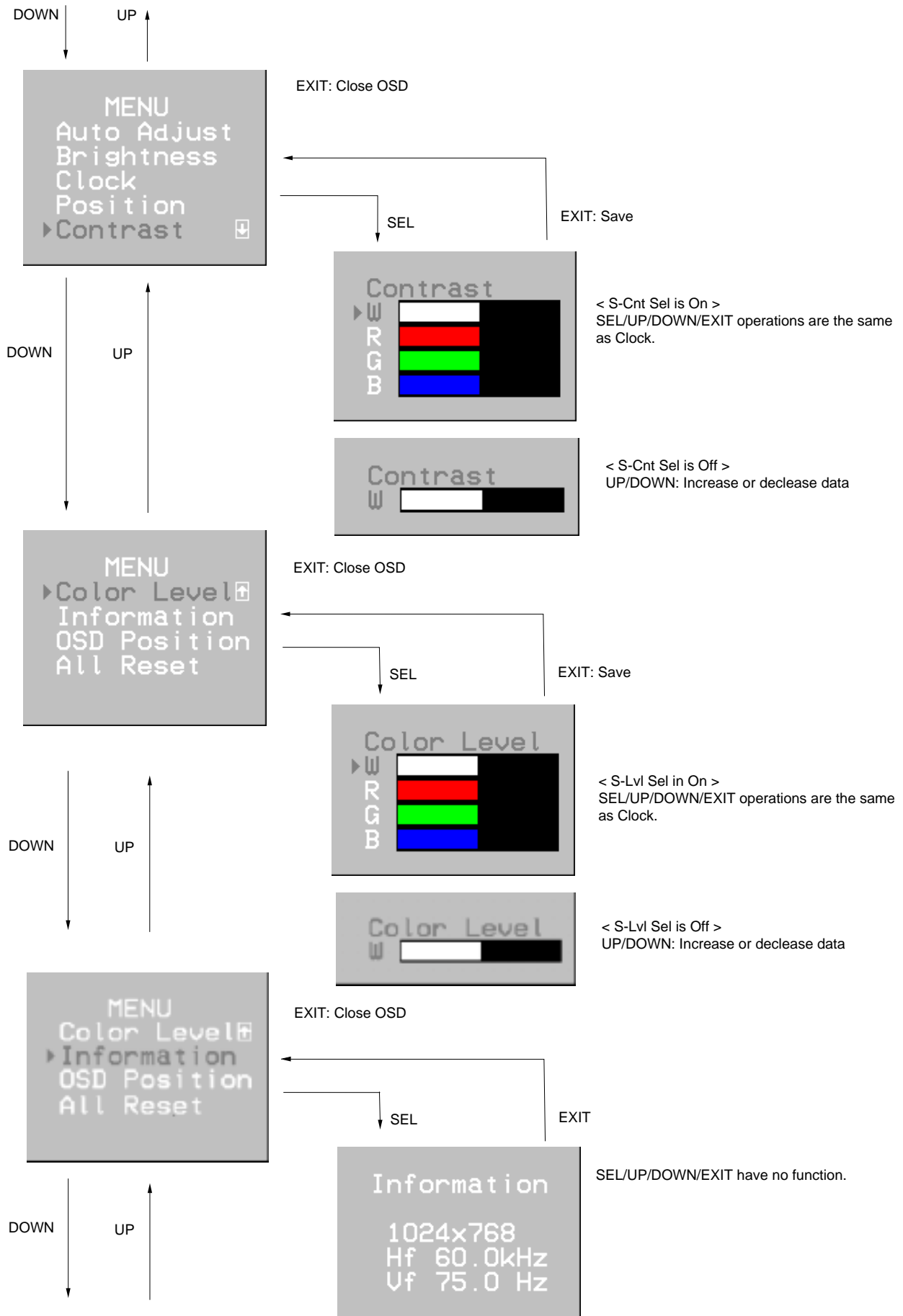

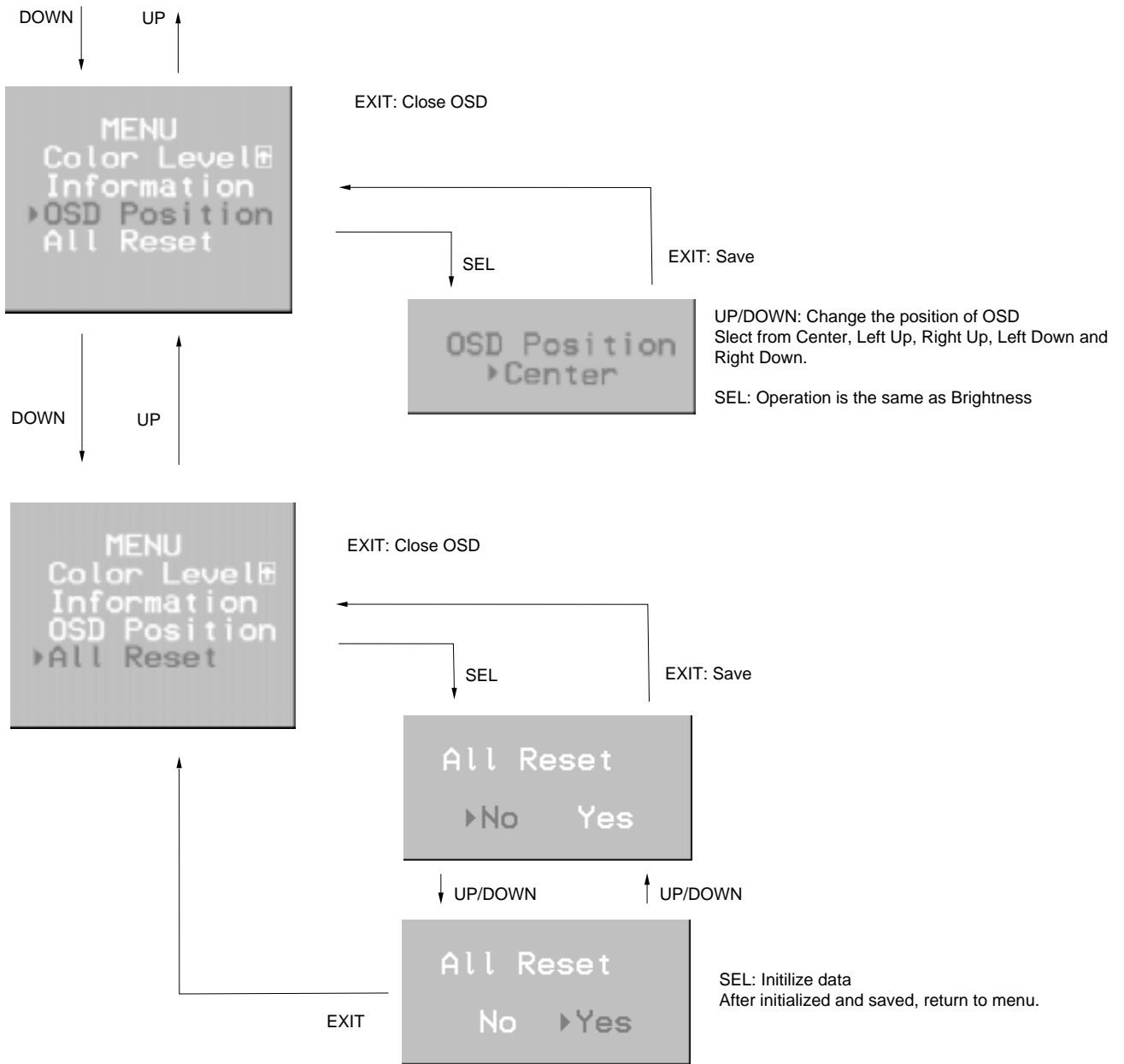

< 7SW mode >

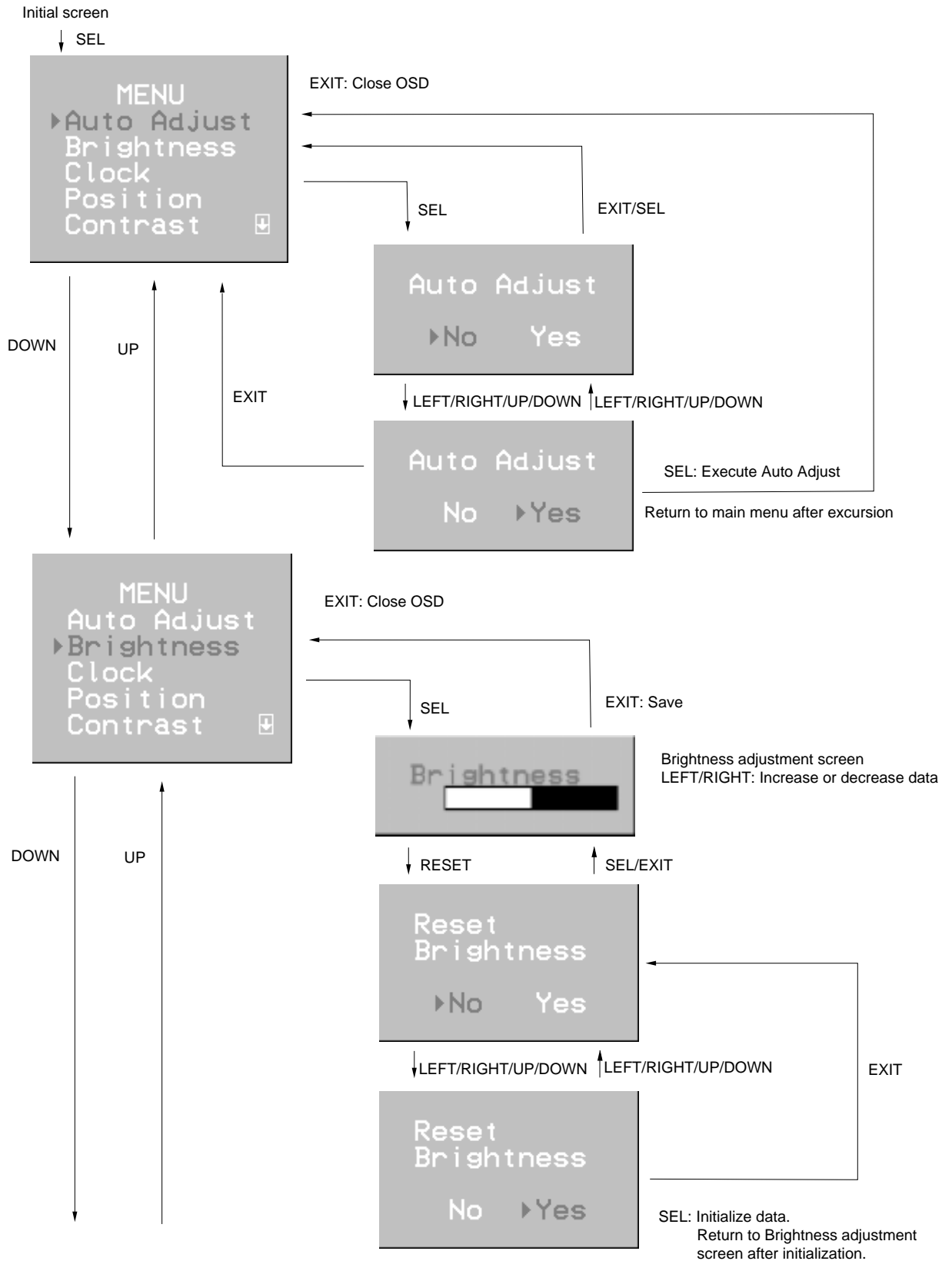

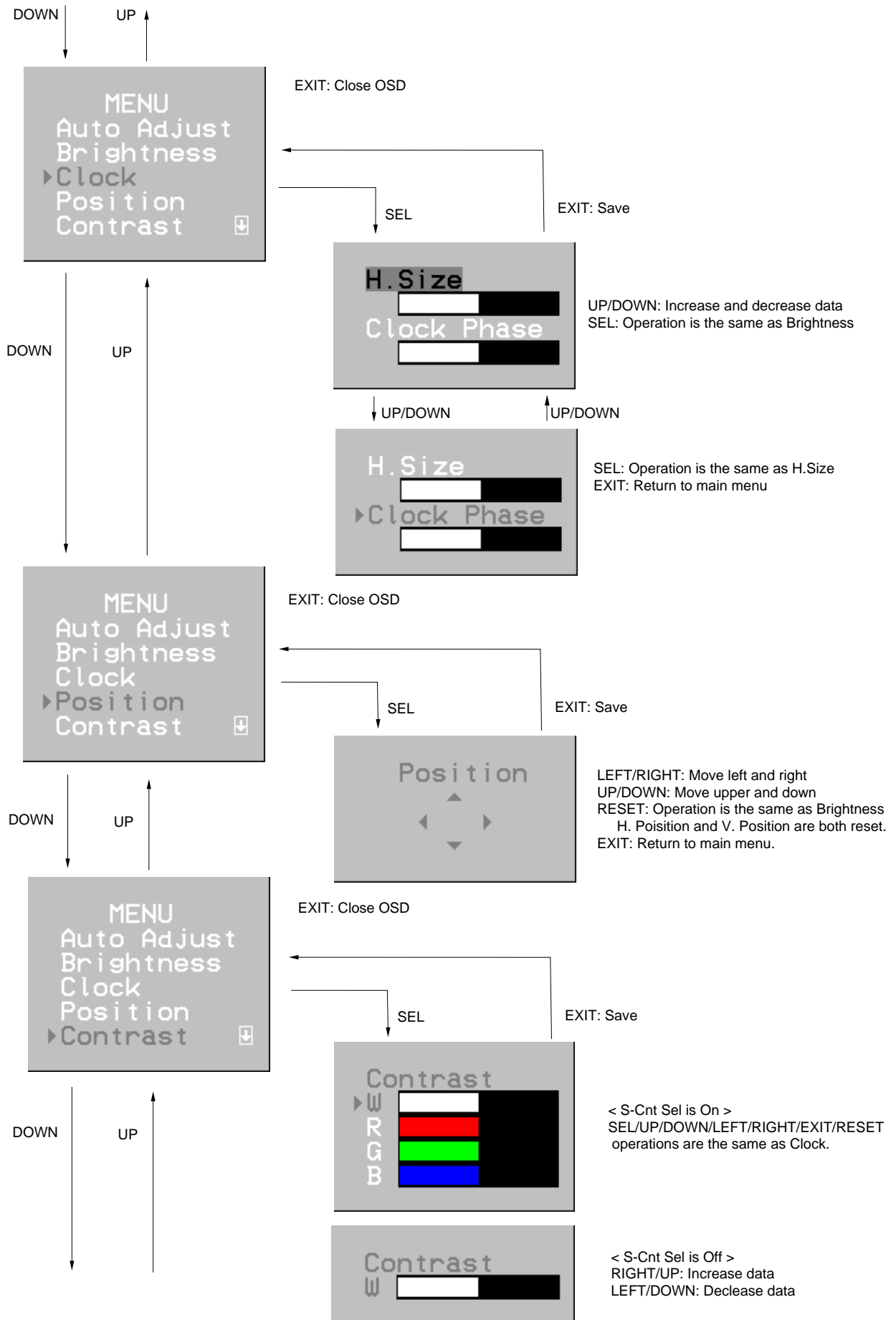

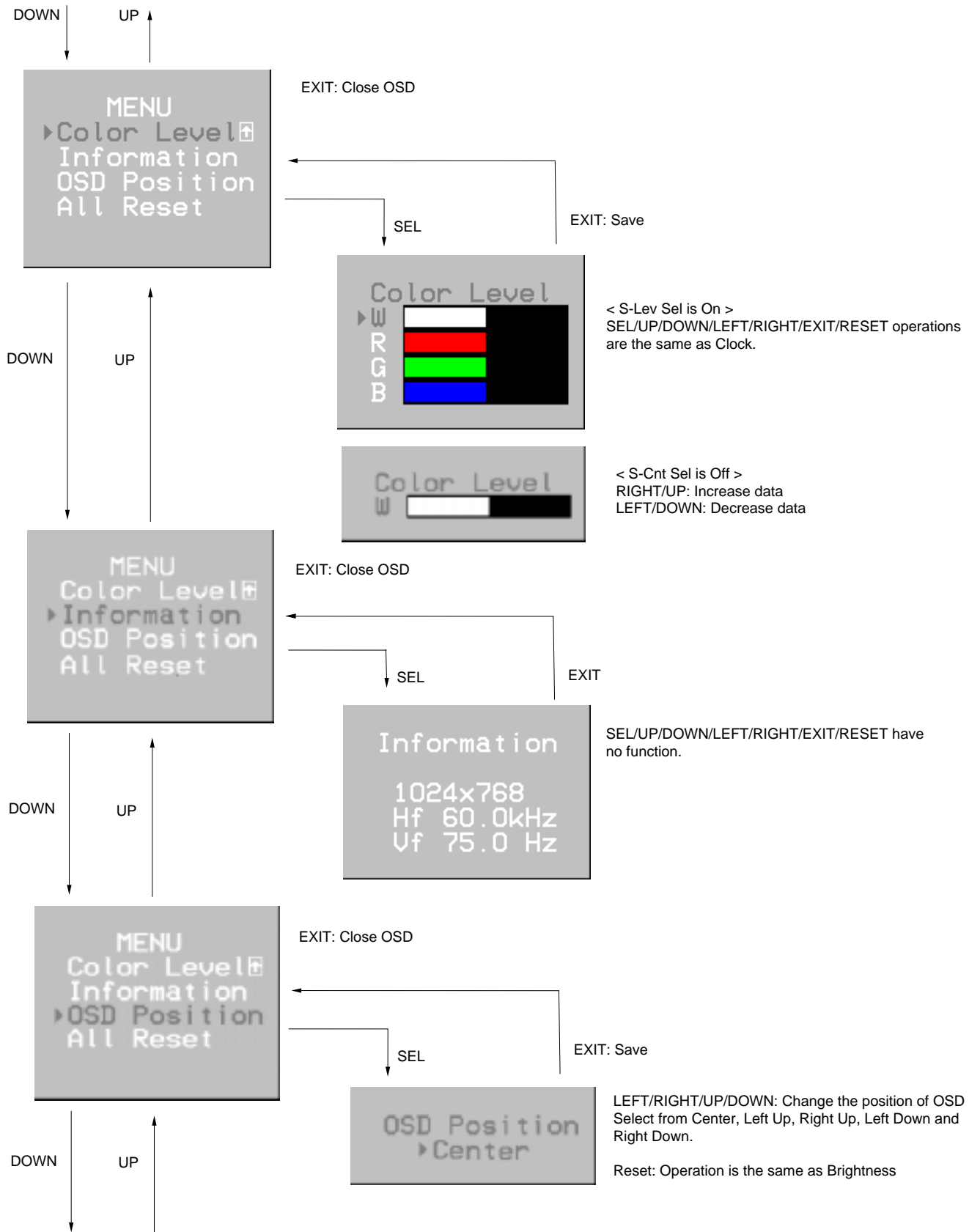

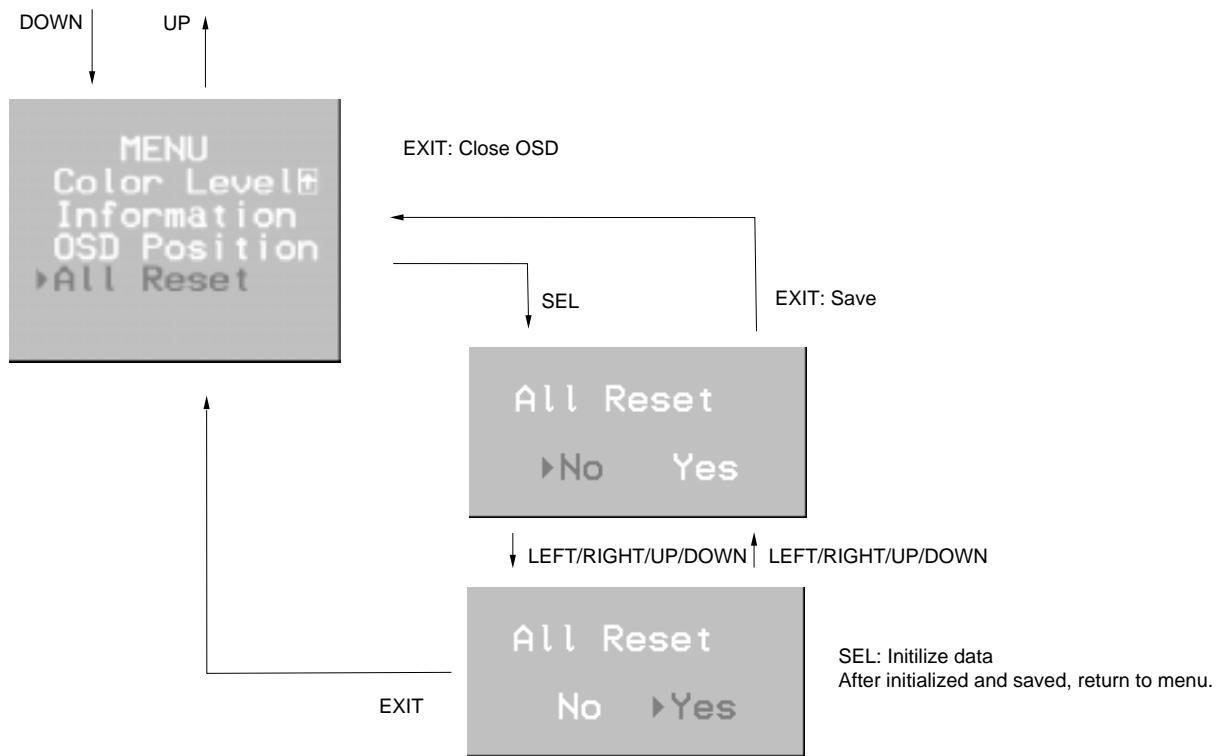

- Remark 1.** LEFT/RIGHT/UP/DOWN signal are input contiguously more than 1 sec. each, the adjustment setting values are sequentially incremented or decremented. If the inputs are less than 1 sec. each setting value is incremented or decremented by 1. However, only even numbers can be set for multiplication value setting.
2. Reset of each adjustment initializes only that adjustment value, while All Reset initializes all adjustment values for all current displayed modes including Brightness, Contrast and Color Level.
  3. Time-out is approx. 10 sec.
  4. The value of Contrast W is synchronizing the values of Contrast R, G and B.
  5. The value of Color Level W is synchronizing the values of Color Level R, G and B.



**CHANGING DEFAULT VALUES**

This LCD module has a capability to change or modify the default values and ODD screen by the customers. The changed values are become the initial values at every each preset timing and also applicable when it is reset (including All reset) in the normal mode.

- 1) Shift to mode of changing defaults  
During the indication of "Information", connect "UP" and "SEL" to ground (GND).
- 2) Operation  
Controlled by SEL/UP/DOWN/EXIT.
- 3) Return to normal mode  
Connect "EXIT" to ground (GND) during non menu mode or turn off the power of LCD module.  
Turn on the "LEDON" and "LEDOFF" simultaneously during this operation.

Controllable Items	Functions
Brightness	The brightness can be changed. The default value is 100.
Color Level	Can change the default values of RGB individually for color level . The default values are 128.
Contrast	Can change the default values of RGB individually or simultaneously for contrast . The default values are 128 for both.
LCD Data	Mode Show the number of Preset timing. No function to change.
	HSE Can change the default of even number.
	Delay Can change the default value of clock delay. The default value is 0 .
	VD Can change the default value of vertical position.
	HD Can change the default value of vertical position.
	Auto Adjust Execute auto adjustment. No default value.
	Par. Delay Can change the compensation value of Auto adjust Delay. Value range: 0 to 255
	Par. HD Can change the compensation value of Auto adjust Horizontal position. Value range: 0 to 127
	LCD Rest Initialize the above values at the factory set.
Sel Data	S-Lvl Sel Invalid the individual RGB Color Level adjustments. In this case, it is not displayed on the menu screen.  ON: Valid individual adjustment OFF: Invalid individual adjustment Default value is ON.
	S-Cnt Sel Invalid the individual RGB Contrast adjustments. In this case, it is not displayed on the menu screen.  ON: Valid individual adjustment OFF: Invalid individual adjustment Default value is ON.
	PSODS Sel Select display or non-display of Power Save OSD.  ON: Display OFF: Non display Default value is OFF.

Controllable Items	Functions
Information	Information of input video signals Display of resolutions and frequencies of Hsync and Vsync.
OSD Position	Can change a default value of the display position of OSD Change the display position of OSD at center, left upper corner, right upper corner, left bottom corner and right bottom corner. The default value is Center.
Used Time	Indicate the elapse times of operation and power save modes. The elapse times are saved every 5 min. It is not saved if the power is turned off within 5 min.  There are no adjustment.
Full Reset	Full reset Initialize the all above adjustment values except Information. Reset to the initial values set by the initialized function or default value when it was shipped from factory. It will take approx. 10 sec. for execution.

- Remarks
1. The values of HSE to Par. HD in LCD Data are memorized at every preset timing.
  2. All selected adjustment items are displayed by OSD.
  3. Other data except Auto Adjust in LCD Data are saved when the menu is returned to upper most menu screen. But it is not save if the power is off during this operation.  
The date of Auto Adjust is saved after auto adjustment is completed.
  4. Please determine after detailed evaluation for the compensation values of Par. Delay and Par. HP in LCD Data

**Information on OSD**

This LCD module displays the following information on OSD.

- 1) Power Save  
Display "No Signal" during 4 sec. when move to power save mode.

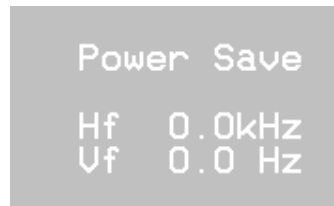

- # Display it with following Hsync. frequency (Hf) and Vsync frequency (Vf) conditions.
- a) Hf < 10kHz
  - b) Vf < 40Hz
  - c) Condition with a) and b)

# It is not displayed when no-display mode of Power Save OSD at PSODS sel of Sel Data in **CHANGING DEFAULT VALUES.**

## 2) Out of Range

Display Hf and Vf during 4 sec. when the input signals are out of range.

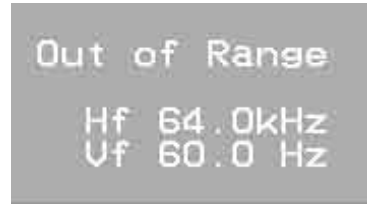

# Display it with following Hf and Vf conditions.

a)  $10\text{kHz} < \text{Hf} < 24\text{kHz}$  or  $90\text{kHz} < \text{Hf}$

b)  $40\text{Hz} < \text{Vf} < 50\text{Hz}$  or  $200\text{Hz} < \text{Vf}$

c) Condition with a) and b)

But it is not displayed when either Hf or Vf is power save mode.

# Cannot select display or non-display the OSD of Out of Range.

## 3) Disable:

Display the disability of adjustment switches (SW) for 4 sec.



OPTICAL CHARACTERISTICS

(Ta = 25°C, VDD = 12 V, VDDb = 12 V)

Item	Symbol	Condition	Min.	Typ.	Max.	Unit	Remark
Contrast ratio	CR	R = 0°, L = 0°, D = 0°, White/Black, at center	150	250			<b>Note 1</b>
Luminance	Lvmax	White, at center	150	200		cd/m <sup>2</sup>	<b>Note 2</b>
Luminance uniformity		White		–	1.30		<b>Note 3</b>
Color gamut	C	R = 0°, L = 0°, U = 0°, D = 0° at center, to NTSC	50	60		%	
Response time	Ton	Black to White		20		ms	<b>Note 5</b>
	Toff	White to Black		40			

Reference data

(Ta = 25°C, VDD = 12 V, VDDb = 12 V)

Item	Symbol	Condition	Min.	Typ.	Max.	Unit	Remark
Viewing angle range	R	CR > 10, U = 0°, D = 0° White/Black, at center	70	85		deg.	<b>Note 4</b>
	L		70	85		deg.	
	U	CR > 10, R = 0°, L = 0° White/Black, at center	70	85		deg.	
	D		70	85		deg.	
Luminance control range		Maximum luminance: 100%		30 100		%	

**Notes 1.** The contrast ratio is calculated by using the following formula.

$$\text{Contrast ratio (CR)} = \frac{\text{Luminance with all pixels in "white"}}{\text{Luminance with all pixels in "black"}}$$

**2.** The luminance is measured after 20 minutes from the module works, with all pixels in "white". The typical value is measured after luminance saturation, more than one hour after burn-in. The timing is UXGA standard mode, preset timing No. 21. See detail **PRESET TIMING**.

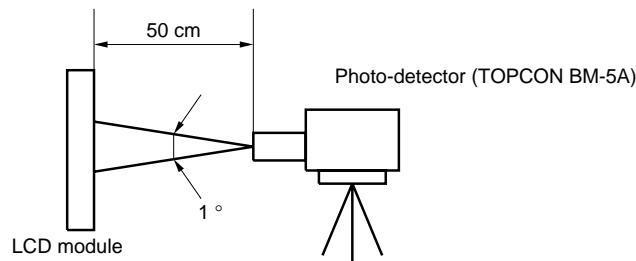

3. Luminance uniformity is calculated by using the following formula.

$$\text{Luminance uniformity} = \frac{\text{Maximum luminance}}{\text{Minimum luminance}}$$

The luminance is measured at near the five points shown below.

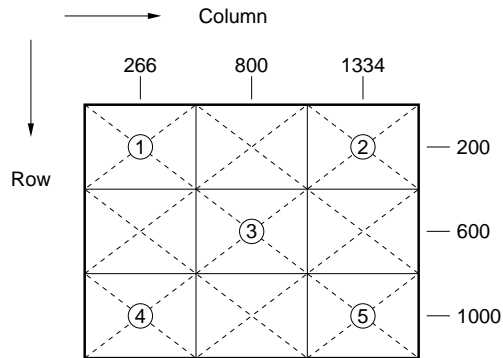

4. Definitions of viewing angle are as follows.

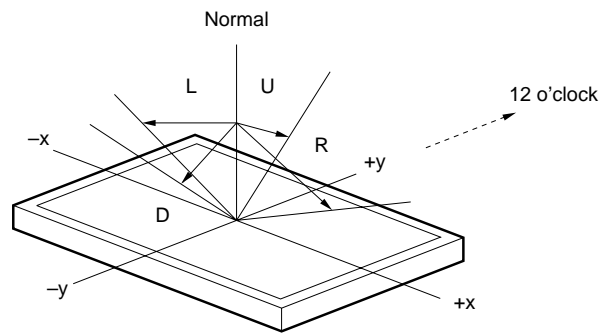

5. Definitions of response time is as follows.

Photo-detector output signal is measured when the luminance changes "white" to "black" or "black" to "white".

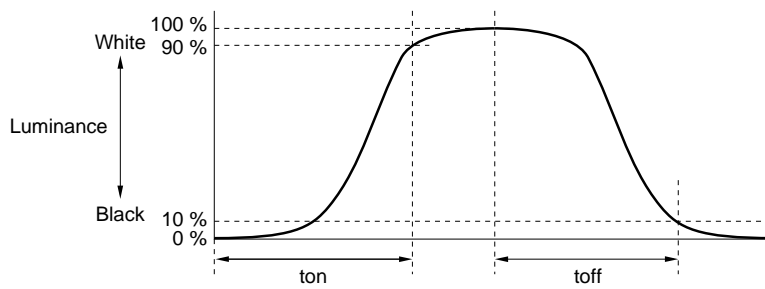

RELIABILITY TEST

Test item	Test condition	Judgment
High temperature/humidity operation	50 ±2°C, 85% relative humidity 240 hours, Display data is white.	<b>Note 1</b>
Heat cycle (operation)	<1> 0°C ±3°C ... 1 hour 55°C ±3°C ... 1 hour <2> 50 cycles, 4 hours/cycle <3> Display data is white.	<b>Note 1</b>
Thermal shock (non-operation)	<1> 20°C ±3°C ... 30 minutes 60°C ±3°C ... 30 minutes <2> 100 cycles <3> Temperature transition time is within 5 minutes.	<b>Note 1</b>
Vibration (non-operation)	<1> 5-100 Hz, 1.2 G 1 minute/cycle, X, Y, Z direction <2> 10 times each direction	<b>Notes 1, 2</b>
Mechanical shock (non-operation)	<1> 30 G, 11 ms X, Y, Z direction <2> 3 times each direction	<b>Notes 1, 2</b>
ESD (operation)	150 pF, 150 , ±10 KV 9 places on a panel 10 times each place at one-second intervals	<b>Note 3</b> <b>Note 1</b>
Dust (operation)	15 kinds of dust (JIS-Z 8901) Hourly 15 seconds stir, 8 times repeat	<b>Note 1</b>

- Notes**
1. Display function is checked by the same condition as LCD module out-going inspection.
  2. Physical damage.
  3. Discharge points are shown in the figure.

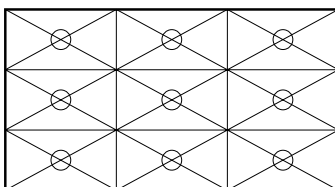

**GENERAL CAUTIONS**

Because next figures and sentences are very important, please understand these contents as follows.

	<b>CAUTION</b>	This figure is a mark that you will get hurt and/or the module will have damages when you make a mistake to operate.
---	----------------	--

	This figure is a mark that you will get an electric shock when you make a mistake to operate.
---	---

	This figure is a mark that you will get hurt when you make a mistake to operate.
---	--

 **CAUTION**

	Do not touch an inverter -- on which is stuck a caution label -- while the LCD module is under the operation, because of dangerous high voltage.
---	--

- (1) Caution when taking out the module a Pick the pouch only, in taking out module from a carrier box.
- (2) Cautions for handling the module
  - a) As the electrostatic discharges may break the LCD module, handle the LCD module with care against electrostaic discharges.
  - b)  As the LCD panel and backlight element are made from fragile glass material, impulse and pressure to the LCD module should be avoided.
  - c) As the surface of polarizer is very soft and easily scratched, use a soft dry cloth without chemicals for cleaning.
  - d) Do not pull the interface connectors in or out while the LCD module is operating.
  - e) Put the module display side down on a horizontal plane.
  - f) Handle connectors and cables with care.
  - g) When the module is operating, do not lose CLK, HS or Vsync signal. If any one of these signals is lost, the LCD panel would be damaged.
  - h) The torque to mounting screw should never exceed 0.392 N·m (4 kgf·cm).
  - i) Don't push or rub the surface of LCD module please.  
If you do the scratches or the marks like rubbing may left on the surface of the module.
- (3) Cautions for the atmosphere
  - a) Dew drop atmosphere should be avoided.
  - b) Do not store and/or operate the LCD module in a high temperature and/or high humidity atmosphere. Storage in an anti-static pouch and under the room temperature atmosphere is recommended.
  - c) This module uses cold cathod fluorescent lamps. Therefore, the life of lamps becomes short if the module is operated under the low temperature environment.
  - d) Do not operate the LCD module in a high magnetic field.
- (4) Caution for the module characteristics
  - a) Do not apply the fixed pattern for a long time to the LCD module. It may cause image sticking. Please use the screen savers if the display pattern is fixed for a long time.
  - b) This module has the retardation film which may cause the variation of the color hue in the different viewing angles. The ununiformity may appear on the screen under the high temperature operation.
  - c) The light vertical stripe may be observed depending on the display pattern. This is not defects or malfunctions.

d) The noise from the inverter circuit may be observed in the luminance control mode. This is not defects or malfunctions.

(5) Other cautions

- a) Do not disassemble and/or reassemble LCD module.
- b) Do not readjust any variable resistors or switches in the module.
- c) When returning the module for repair or etc., please pack the module properly to avoid any damages. We recommend using the original shipping packages.
- d) In case that the scan converter is used to convert VGA signal to NTSC, it is recommended using the frame-memory type, not the line-memory.

Liquid Crystal Display has the following specific characteristics. There are not defects nor malfunctions.

The optical characteristics of this module may be affected by the ambient temperature.

This module has cold cathode tube for backlight. Optical characteristics, like luminance or uniformity, will be changed by the progress in time.

Uneven brightness and/or small spots may be observed depending on different display patterns.



OUTLINE DRAWINGS

Front View (Unit in mm)

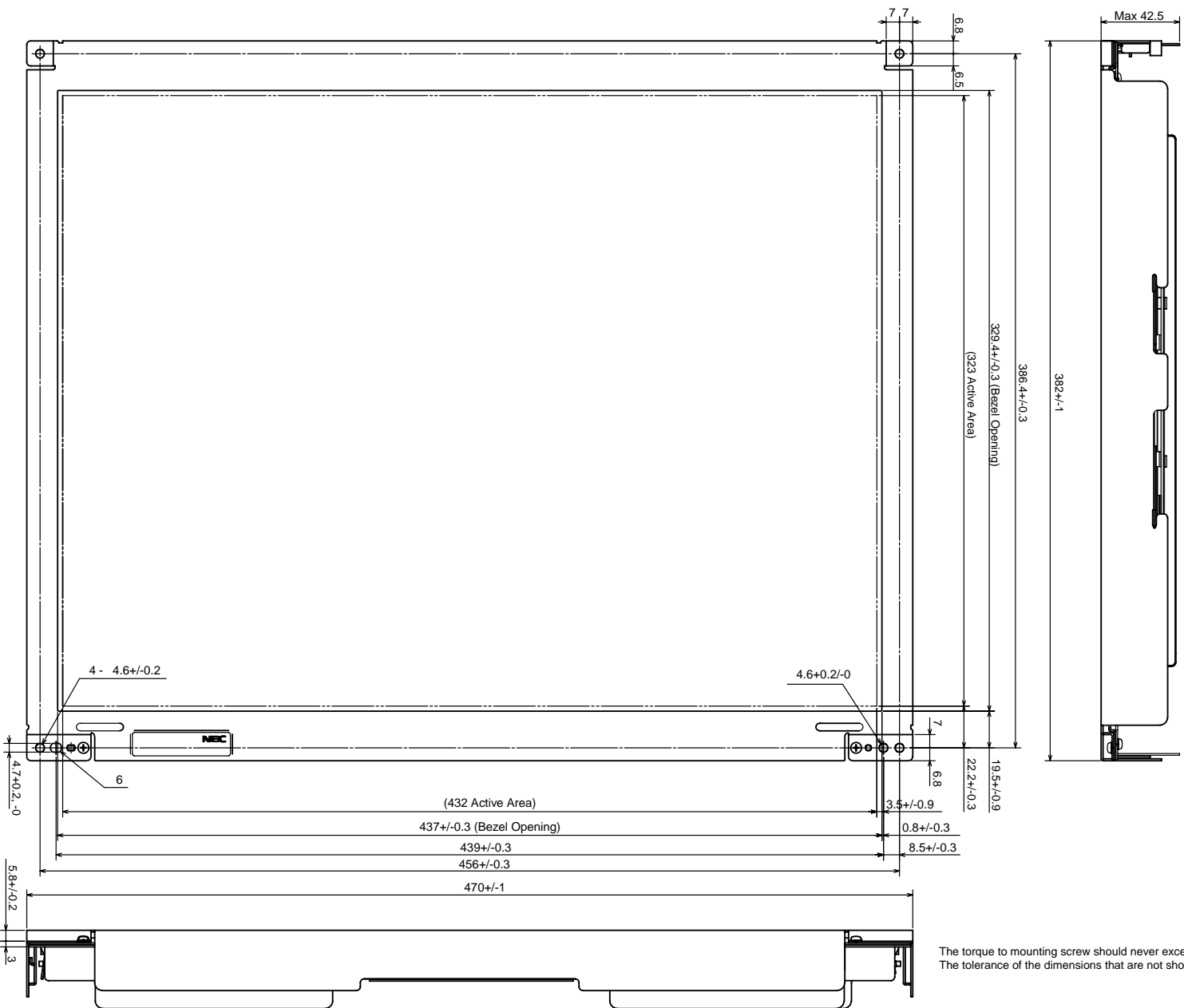

The torque to mounting screw should never exceed 0.392N · m (4 kg · cm).  
The tolerance of the dimensions that are not shown is ±0.5 mm.

OUTLINE DRAWINGS

Rear View (Unit in mm)

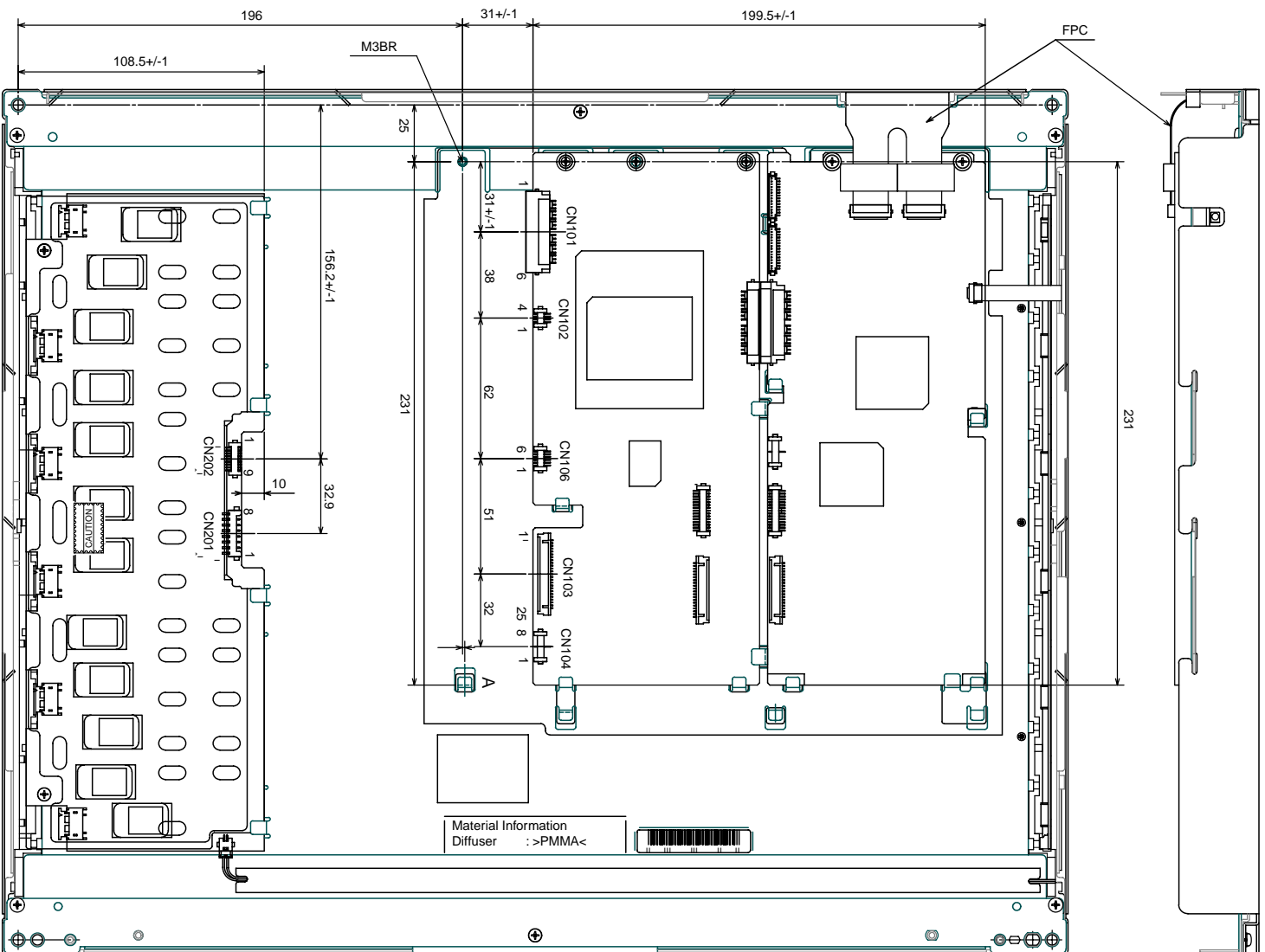

\* The tolerances not shown in this drawing are +/- 0.5mm.

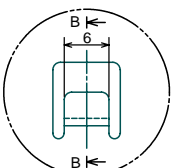

Detail A

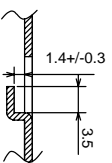

Section B-B

No part of this document may be copied or reproduced in any form or by any means without the prior written consent of NEC Corporation. NEC Corporation assumes no responsibility for any errors which may appear in this document.

NEC Corporation does not assume any liability for infringement of patents, copyrights or other intellectual property rights of third parties by or arising from use of a device described herein or any other liability arising from use of such device. No license, either express, implied or otherwise, is granted under any patents, copyrights or other intellectual property rights of NEC Corporation or others.

While NEC Corporation has been making continuous effort to enhance the reliability of its electronic components, the possibility of defects cannot be eliminated entirely. To minimize risks of damage or injury to persons or property arising from a defect in an NEC electronic component, customers must incorporate sufficient safety measures in its design, such as redundancy, fire-containment, and anti-failure features.

NEC devices are classified into the following three quality grades:

"Standard", "Special", and "Specific". The Specific quality grade applies only to devices developed based on a customer designated "quality assurance program" for a specific application. The recommended applications of a device depend on its quality grade, as indicated below. Customers must check the quality grade of each device before using it in a particular application.

Standard: Computers, office equipment, communications equipment, test and measurement equipment, audio and visual equipment, home electronic appliances, machine tools, personal electronic equipment and industrial robots

Special: Transportation equipment (automobiles, trains, ships, etc.), traffic control systems, anti-disaster systems, anti-crime systems, safety equipment and medical equipment (not specifically designed for life support)

Specific: Aircrafts, aerospace equipment, submersible repeaters, nuclear reactor control systems, life support systems or medical equipment for life support, etc.

The quality grade of NEC devices is "Standard" unless otherwise specified in NEC's Data Sheets or Data Books. If customers intend to use NEC devices for applications other than those specified for Standard quality grade, they should contact an NEC sales representative in advance.

Anti-radioactive design is not implemented in this product.

---