

Single 2-Input NAND Gate

NL17SV00

The NL17SV00 is a single 2-input NAND gate in tiny footprint packages. The device is designed to operate for $V_{CC} = 0.9\text{ V}$ to 3.6 V .

Features

- Designed for 0.9 V to 3.6 V V_{CC} Operation
- 1.5 ns t_{PD} at 3.3 V (Typ)
- Inputs/Outputs Over-Voltage Tolerant up to 3.6 V
- I_{OFF} Supports Partial Power Down Protection
- Source/Sink 24 mA at 3.3 V
- Available in SOT-353, SOT-553, SOT-953, SC-74A and UDFN Packages
- NLV Prefix for Automotive and Other Applications Requiring Unique Site and Control Change Requirements; AEC-Q100 Qualified and PPAP Capable
- These Devices are Pb-Free, Halogen Free/BFR Free and are RoHS Compliant

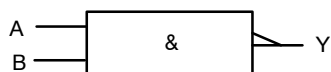
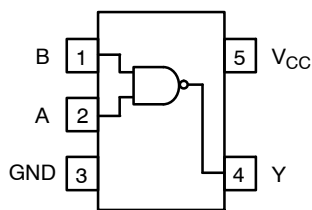
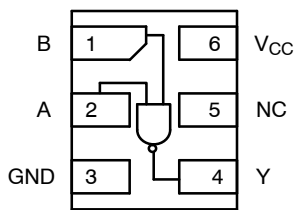

Figure 1. Logic Symbol



(SC-88A / SOT-553 / SC-74A)



UDFN6

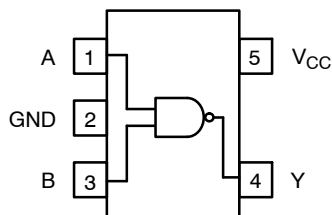

SOT-953

Figure 2. Pinout (Top View)



ON Semiconductor®

www.onsemi.com

MARKING DIAGRAMS



SC-74A
CASE 318BQ

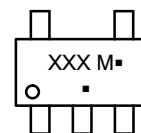

SC-88A
(SC-70-5/SOT-353)
CASE 419A-02

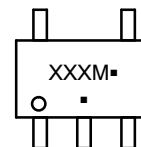

SOT-553, 5 LEAD
CASE 463B

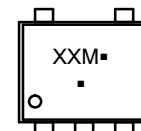

SOT-953
CASE 527AE

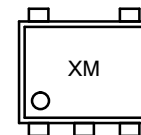

UDFN6, 1.45x1.0, 0.5P
CASE 517AQ

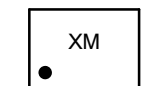

UDFN6, 1x1, 0.35P
CASE 517BX

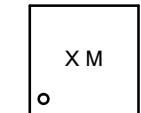

X, XX = Specific Device Code
M = Date Code*
▪ = Pb-Free Package

(Note: Microdot may be in either location)

*This information is generic. Please refer to device data sheet for actual part marking. Pb-Free indicator, "G" or microdot "▪", may or may not be present.

ORDERING INFORMATION

See detailed ordering, marking and shipping information in the package dimensions section on page 6 of this data sheet.

NL17SV00

PIN ASSIGNMENT

Pin	SOT-953	SC88A / SOT553 / SC-74A	UDFN6
1	A	B	B
2	GND	A	A
3	B	GND	GND
4	Y	Y	Y
5	V _{CC}	V _{CC}	NC
6	-	-	V _{CC}

FUNCTION TABLE

Input		Output
A	B	Y
L	L	H
L	H	H
H	L	H
H	H	L

MAXIMUM RATINGS

Symbol	Characteristics	Value	Unit
V _{CC}	DC Supply Voltage	-0.5 to +4.3	V
V _{IN}	DC Input Voltage	-0.5 to +4.3	V
V _{OUT}	DC Output Voltage Active-Mode (High or Low State) Tri-State Mode (Note 1) Power-Down Mode (V _{CC} = 0 V)	-0.5 to V _{CC} + 0.5 -0.5 to +4.3 -0.5 to +4.3	V
I _{IK}	DC Input Diode Current V _{IN} < GND	-50	mA
I _{OK}	DC Output Diode Current V _{OUT} < GND	-50	mA
I _{OUT}	DC Output Source/Sink Current	±50	mA
I _{CC} or I _{GND}	DC Supply Current per Supply Pin or Ground Pin	±50	mA
T _{STG}	Storage Temperature Range	-65 to +150	°C
T _L	Lead Temperature, 1 mm from Case for 10 Seconds	260	°C
T _J	Junction Temperature Under Bias	+150	°C
θ _{JA}	Thermal Resistance (Note 2) SC-88A SOT-553 SOT-953 SC-74A UDFN6	377 324 254 320 154	°C/W
P _D	Power Dissipation in Still Air SC-88A SOT-553 SOT-953 SC-74A UDFN6	332 386 491 390 812	mW
MSL	Moisture Sensitivity	Level 1	-
F _R	Flammability Rating Oxygen Index: 28 to 34	UL 94 V-0 @ 0.125 in	-
V _{ESD}	ESD Withstand Voltage (Note 3) Human Body Model Charged Device Model	2000 1000	V
I _{Latchup}	Latchup Performance (Note 4)	±100	mA

Stresses exceeding those listed in the Maximum Ratings table may damage the device. If any of these limits are exceeded, device functionality should not be assumed, damage may occur and reliability may be affected.

1. Applicable to devices with outputs that may be tri-stated.
2. Measured with minimum pad spacing on an FR4 board, using 10 mm-by-1 inch, 2 ounce copper trace no air flow per JESD51-7.
3. HBM tested to EIA / JESD22-A114-A. CDM tested to JESD22-C101-A. JEDEC recommends that ESD qualification to EIA/JESD22-A115A (Machine Model) be discontinued.
4. Tested to EIA/JESD78 Class II.

NL17SV00

RECOMMENDED OPERATING CONDITIONS

Symbol	Parameter	Min	Max	Unit
V _{CC}	Positive DC Supply Voltage	0.9	3.6	V
V _{IN}	DC Input Voltage	0	3.6	V
V _{OUT}	DC Output Voltage Active-Mode (High or Low State) Tri-State Mode (Note 1) Power-Down Mode (V _{CC} = 0 V)	0	V _{CC}	
		0	3.6	
		0	3.6	
T _A	Operating Temperature Range	-55	+125	°C
t _r , t _f	Input Transition Rise and Fall Time	0	20	ns/V

Functional operation above the stresses listed in the Recommended Operating Ranges is not implied. Extended exposure to stresses beyond the Recommended Operating Ranges limits may affect device reliability.

DC ELECTRICAL CHARACTERISTICS

Symbol	Parameter	Condition	V _{CC} (V)	T _A = 25°C			T _A = -55°C to +125°C		Unit
				Min	Typ	Max	Min	Max	
V _{IH}	High-Level Input Voltage		0.9	-	0.5	-	-	-	V
			1.1 to 1.3	0.65 x V _{CC}	-	-	0.65 x V _{CC}	-	
			1.4 to 1.6	0.65 x V _{CC}	-	-	0.65 x V _{CC}	-	
			1.65 to 1.95	0.65 x V _{CC}	-	-	0.65 x V _{CC}	-	
			2.3 to < 2.7	1.6	-	-	1.6	-	
			2.7 to 3.6	2.0	-	-	2.0	-	
V _{IL}	Low-Level Input Voltage		0.9	-	0.5	-	-	-	V
			1.1 to 1.3	-	-	0.35 x V _{CC}	-	0.35 x V _{CC}	
			1.4 to 1.6	-	-	0.35 x V _{CC}	-	0.35 x V _{CC}	
			1.65 to 1.95	-	-	0.35 x V _{CC}	-	0.35 x V _{CC}	
			2.3 to < 2.7	-	-	0.7	-	0.7	
			2.7 to 3.6	-	-	0.8	-	0.8	
V _{OH}	High-Level Output Voltage	V _{IN} = V _{IH} or V _{IL}							V
		I _{OH} = -100 μA	0.9	-	V _{CC} - 0.1	-	-	-	
			1.1 to 1.3	V _{CC} - 0.1	-	-	V _{CC} - 0.1	-	
			1.4 to 1.6	V _{CC} - 0.1	-	-	V _{CC} - 0.1	-	
			1.65 to 1.95	V _{CC} - 0.2	-	-	V _{CC} - 0.2	-	
			2.3 to < 2.7	V _{CC} - 0.2	-	-	V _{CC} - 0.2	-	
			2.7 to 3.6	V _{CC} - 0.2	-	-	V _{CC} - 0.2	-	
		I _{OH} = -2 mA	1.1 to 1.3	0.75 x V _{CC}	-	-	0.75 x V _{CC}	-	
			1.4 to 1.6	0.75 x V _{CC}	-	-	0.75 x V _{CC}	-	
		I _{OH} = -4 mA	1.65 to 1.95	1.25	-	-	1.25	-	
			2.3 to 2.7	2.0	-	-	2.0	-	
		I _{OH} = -6 mA	2.3 to 2.7	1.8	-	-	1.8	-	
			2.7 to 3.6	2.2	-	-	2.2	-	
		I _{OH} = -12 mA	2.3 to 2.7	1.7	-	-	1.7	-	
			2.7 to 3.6	2.4	-	-	2.4	-	
I _{OH} = -18 mA	2.3 to 2.7	1.7	-	-	1.7	-			
	2.7 to 3.6	2.4	-	-	2.4	-			
I _{OH} = -24 mA	2.7 to 3.6	2.2	-	-	2.2	-			

NL17SV00

DC ELECTRICAL CHARACTERISTICS (continued)

Symbol	Parameter	Condition	V _{CC} (V)	T _A = 25°C			T _A = -55°C to +125°C		Unit	
				Min	Typ	Max	Min	Max		
V _{OL}	Low-Level Output Voltage	V _{IN} = V _{IH} or V _{IL}							V	
		I _{OL} = 100 μA	0.9	-	0.1	-	-	-		-
			1.1 to 1.3	-	-	0.1	-	-		0.1
			1.4 to 1.6	-	-	0.1	-	-		0.1
			1.65 to 1.95	-	-	0.2	-	-		0.2
			2.3 to < 2.7	-	-	0.2	-	-		0.2
			2.7 to 3.6	-	-	0.2	-	-		0.2
		I _{OL} = 2 mA	1.1 to 1.3	-	-	0.25 x V _{CC}	-	-		0.25 x V _{CC}
		I _{OL} = 4 mA	1.4 to 1.6	-	-	0.25 x V _{CC}	-	-		0.25 x V _{CC}
		I _{OL} = 6 mA	1.65 to 1.95	-	-	0.3	-	-		0.3
			2.3 to 2.7	-	-	0.3	-	-		0.3
		I _{OL} = 12 mA	2.3 to 2.7	-	-	0.4	-	-		0.4
			2.7 to 3.6	-	-	0.4	-	-		0.4
I _{OL} = 18 mA	2.3 to 2.7	-	-	0.6	-	-	0.6			
	2.7 to 3.6	-	-	0.4	-	-	0.4			
I _{OL} = 24 mA	2.7 to 3.6	-	-	0.55	-	-	0.55			
I _{IN}	Input Leakage Current	V _{IN} = 3.6 V or GND	0.9 to 3.6	-	-	±0.1	-	±0.9	μA	
I _{OFF}	Power Off Leakage Current	V _{IN} = 3.6 V or V _{OUT} = 3.6 V	0	-	-	1.0	-	5.0	μA	
I _{CC}	Quiescent Supply Current	V _{IN} = V _{CC} or GND	0.9 to 3.6	-	-	0.9	-	5.0	μA	

Product parametric performance is indicated in the Electrical Characteristics for the listed test conditions, unless otherwise noted. Product performance may not be indicated by the Electrical Characteristics if operated under different conditions.

AC ELECTRICAL CHARACTERISTICS

Symbol	Parameter	Condition	V _{CC} (V)	T _A = 25°C			T _A = -55°C to +125°C		Unit
				Min	Typ	Max	Min	Max	
t _{PLH} , t _{PHL}	Propagation Delay, (A or B) to Y (Figures 3 and 4)	R _L = 1 MΩ, C _L = 15 pF	0.9	-	14.6	-	-	-	ns
		R _L = 2 kΩ, C _L = 15 pF	1.10 to 1.30	-	6.3	10.1	-	14.6	
			1.40 to 1.60	-	3.4	6.0	-	7.2	
		R _L = 500 Ω, C _L = 30 pF	1.65 to 1.95	-	2.4	4.5	-	5.3	
			2.3 to 2.7	-	1.8	2.6	-	3.7	
			2.7 to 3.6	-	1.5	2.3	-	3.0	

CAPACITIVE CHARACTERISTICS

Symbol	Parameter	Test Condition	Typical (T _A = 25°C)	Unit
C _{IN}	Input Capacitance	V _{CC} = 0 V	2.0	pF
C _{OUT}	Output Capacitance	V _{CC} = 0 V	4.5	pF
C _{PD}	Power Dissipation Capacitance (Note 5)	10 MHz, V _{CC} = 0.9 to 3.6 V, V _{IN} = 0 V or V _{CC}	20	pF

5. C_{PD} is defined as the value of the internal equivalent capacitance which is calculated from the operating current consumption without load. Average operating current can be obtained by the equation I_{CC(OPR)} = C_{PD} • V_{CC} • f_{in} + I_{CC}. C_{PD} is used to determine the no-load dynamic power consumption: P_D = C_{PD} • V_{CC}² • f_{in} + I_{CC} • V_{CC}.

NL17SV00

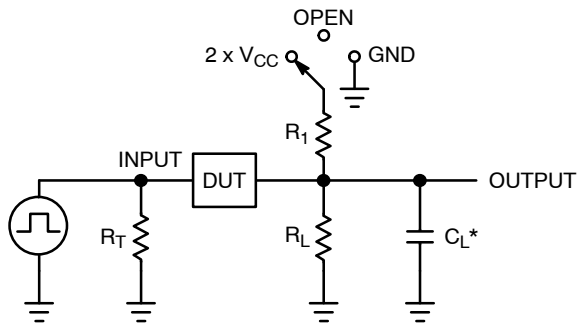

C_L includes probe and jig capacitance
 R_T is Z_{OUT} of pulse generator (typically 50 Ω)
 $f = 1$ MHz

Test	Switch Position
t_{PLH} / t_{PHL}	Open
t_{PLZ} / t_{PZL}	$2 \times V_{CC}$
t_{PHZ} / t_{PZH}	GND

Figure 3. Test Circuit

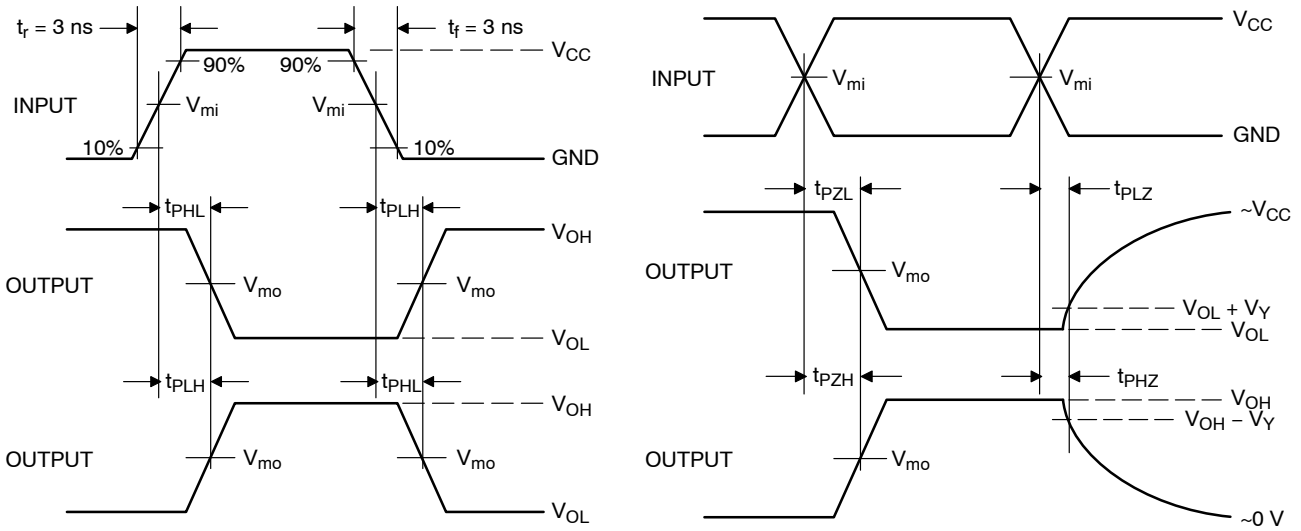

V_{CC}, V	V_{mi}, V	V_{mo}, V		V_Y, V
		t_{PLH}, t_{PHL}	$t_{PZL}, t_{PLZ}, t_{PZH}, t_{PHZ}$	
0.9	$V_{CC}/2$	$V_{CC}/2$	$V_{CC}/2$	0.1
1.1 to 1.3	$V_{CC}/2$	$V_{CC}/2$	$V_{CC}/2$	0.1
1.4 to 1.6	$V_{CC}/2$	$V_{CC}/2$	$V_{CC}/2$	0.1
1.65 to 1.95	$V_{CC}/2$	$V_{CC}/2$	$V_{CC}/2$	0.15
2.3 to 2.7	$V_{CC}/2$	$V_{CC}/2$	$V_{CC}/2$	0.15
3.0 to 3.6	1.5	1.5	1.5	0.3

Figure 4. Switching Waveforms

NL17SV00

ORDERING INFORMATION

Device	Package	Marking	Pin 1 Orientation (See below)	Shipping [†]
NL17SV00DFT2G (Contact ON Semiconductor)	SC-88A	TBD	Q4	3000 / Tape & Reel
NL17SV00XV5T2G	SOT-553	UH	Q4	4000 / Tape & Reel
NL17SV00P5T5G (Contact ON Semiconductor)	SOT-953	TBD	Q2	8000 / Tape & Reel
NL17SV00DBVT1G (Contact ON Semiconductor)	SC-74A	TBD	Q4	3000 / Tape & Reel
NL17SV00MU1TCG (Contact ON Semiconductor)	UDFN6, 1.45 x 1.0, 0.5P	TBD	Q4	3000 / Tape & Reel
NL17SV00MU3TCG (Contact ON Semiconductor)	UDFN6, 1.0 x 1.0, 0.35P	TBD	Q4	3000 / Tape & Reel

[†]For information on tape and reel specifications, including part orientation and tape sizes, please refer to our Tape and Reel Packaging Specifications Brochure, BRD8011/D.

*NLV Prefix for Automotive and Other Applications Requiring Unique Site and Control Change Requirements; AEC-Q100 Qualified and PPAP Capable.

Pin 1 Orientation in Tape and Reel

Direction of Feed

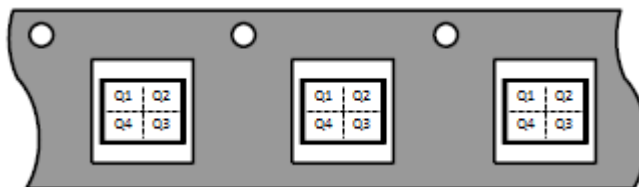

NL17SV00

PACKAGE DIMENSIONS

SC-74A
CASE 318BQ
ISSUE B

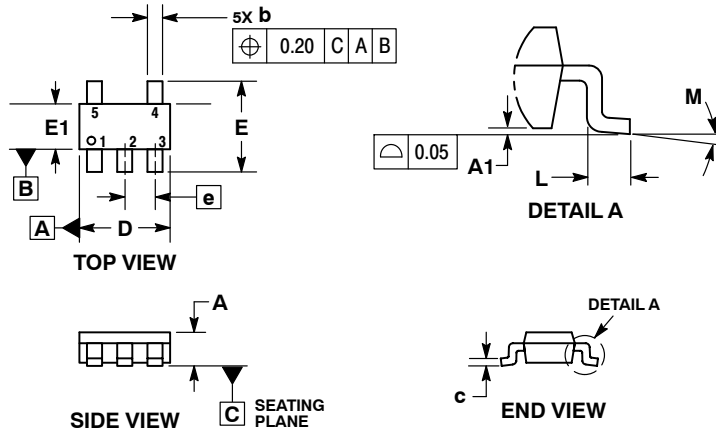

NOTES:

1. DIMENSIONING AND TOLERANCING PER ASME Y14.5M, 1994.
2. CONTROLLING DIMENSION: MILLIMETERS.
3. MAXIMUM LEAD THICKNESS INCLUDES LEAD FINISH THICKNESS. MINIMUM LEAD THICKNESS IS THE MINIMUM THICKNESS OF BASE MATERIAL.
4. DIMENSIONS A AND B DO NOT INCLUDE MOLD FLASH, PROTRUSIONS, OR GATE BURRS. MOLD FLASH, PROTRUSIONS, OR GATE BURRS SHALL NOT EXCEED 0.15 PER SIDE.

DIM	MILLIMETERS	
	MIN	MAX
A	0.90	1.10
A1	0.01	0.10
b	0.25	0.50
c	0.10	0.26
D	2.85	3.15
E	2.50	3.00
E1	1.35	1.65
e	0.95 BSC	
L	0.20	0.60
M	0°	10°

**RECOMMENDED
SOLDERING FOOTPRINT***

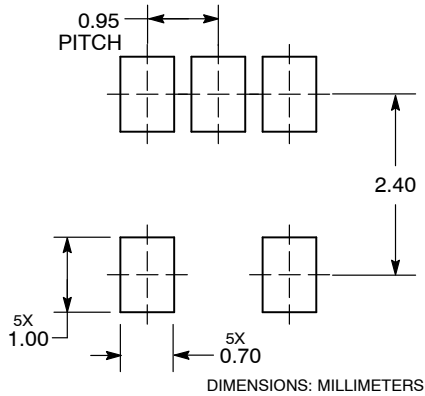

*For additional information on our Pb-Free strategy and soldering details, please download the ON Semiconductor Soldering and Mounting Techniques Reference Manual, SOLDERRM/D.

NL17SV00

PACKAGE DIMENSIONS

SOT-553, 5 LEAD CASE 463B ISSUE C

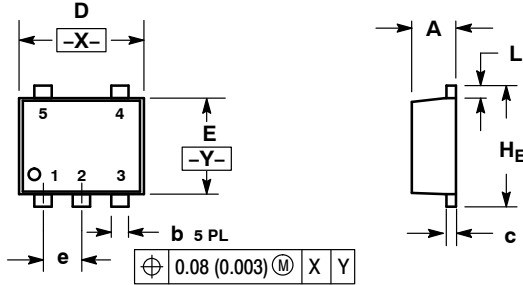

NOTES:

1. DIMENSIONING AND TOLERANCING PER ANSI Y14.5M, 1982.
2. CONTROLLING DIMENSION: MILLIMETERS
3. MAXIMUM LEAD THICKNESS INCLUDES LEAD FINISH THICKNESS. MINIMUM LEAD THICKNESS IS THE MINIMUM THICKNESS OF BASE MATERIAL.

DIM	MILLIMETERS			INCHES		
	MIN	NOM	MAX	MIN	NOM	MAX
A	0.50	0.55	0.60	0.020	0.022	0.024
b	0.17	0.22	0.27	0.007	0.009	0.011
c	0.08	0.13	0.18	0.003	0.005	0.007
D	1.55	1.60	1.65	0.061	0.063	0.065
E	1.15	1.20	1.25	0.045	0.047	0.049
e	0.50 BSC			0.020 BSC		
L	0.10	0.20	0.30	0.004	0.008	0.012
HE	1.55	1.60	1.65	0.061	0.063	0.065

RECOMMENDED SOLDERING FOOTPRINT*

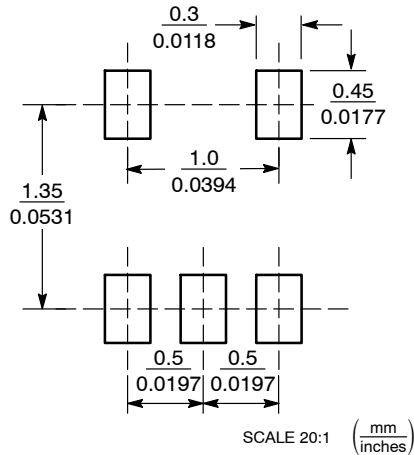

*For additional information on our Pb-Free strategy and soldering details, please download the ON Semiconductor Soldering and Mounting Techniques Reference Manual, SOLDERRM/D.

STYLE 1:

- PIN 1. BASE
- 2. EMITTER
- 3. BASE
- 4. COLLECTOR
- 5. COLLECTOR

STYLE 2:

- PIN 1. CATHODE
- 2. COMMON ANODE
- 3. CATHODE 2
- 4. CATHODE 3
- 5. CATHODE 4

STYLE 3:

- PIN 1. ANODE 1
- 2. N/C
- 3. ANODE 2
- 4. CATHODE 2
- 5. CATHODE 1

STYLE 4:

- PIN 1. SOURCE 1
- 2. DRAIN 1/2
- 3. SOURCE 1
- 4. GATE 1
- 5. GATE 2

STYLE 5:

- PIN 1. ANODE
- 2. EMITTER
- 3. BASE
- 4. COLLECTOR
- 5. CATHODE

STYLE 6:

- PIN 1. EMITTER 2
- 2. BASE 2
- 3. EMITTER 1
- 4. COLLECTOR 1
- 5. COLLECTOR 2/BASE 1

STYLE 7:

- PIN 1. BASE
- 2. EMITTER
- 3. BASE
- 4. COLLECTOR
- 5. COLLECTOR

STYLE 8:

- PIN 1. CATHODE
- 2. COLLECTOR
- 3. N/C
- 4. BASE
- 5. EMITTER

STYLE 9:

- PIN 1. ANODE
- 2. CATHODE
- 3. ANODE
- 4. ANODE
- 5. ANODE

NL17SV00

PACKAGE DIMENSIONS

UDFN6, 1.45x1.0, 0.5P
CASE 517AQ
ISSUE O

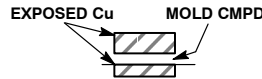
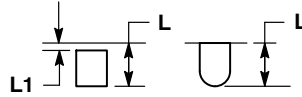
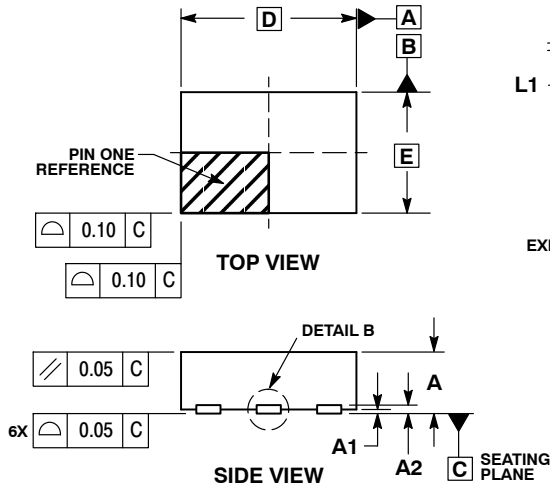

NOTES:

1. DIMENSIONING AND TOLERANCING PER ASME Y14.5M, 1994.
2. CONTROLLING DIMENSION: MILLIMETERS.
3. DIMENSION b APPLIES TO PLATED TERMINAL AND IS MEASURED BETWEEN 0.15 AND 0.30 mm FROM THE TERMINAL TIP.

MILLIMETERS		
DIM	MIN	MAX
A	0.45	0.55
A1	0.00	0.05
A2	0.07	REF
b	0.20	0.30
D	1.45	BSC
E	1.00	BSC
e	0.50	BSC
L	0.30	0.40
L1	---	0.15

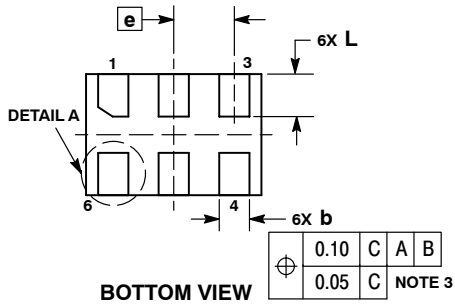

MOUNTING FOOTPRINT

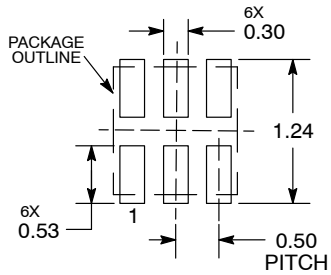

DIMENSIONS: MILLIMETERS

*For additional information on our Pb-Free strategy and soldering details, please download the ON Semiconductor Soldering and Mounting Techniques Reference Manual, SOLDERRM/D.

NL17SV00

PACKAGE DIMENSIONS

UDFN6, 1x1, 0.35P
CASE 517BX
ISSUE O

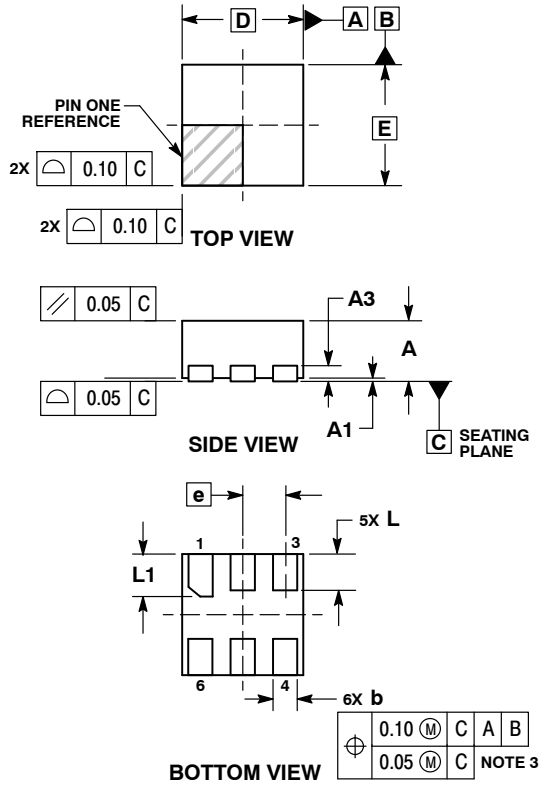

NOTES:

1. DIMENSIONING AND TOLERANCING PER ASME Y14.5M, 1994.
2. CONTROLLING DIMENSION: MILLIMETERS.
3. DIMENSION b APPLIES TO PLATED TERMINAL AND IS MEASURED BETWEEN 0.15 AND 0.20 MM FROM TERMINAL TIP.
4. PACKAGE DIMENSIONS EXCLUSIVE OF BURRS AND MOLD FLASH.

MILLIMETERS		
DIM	MIN	MAX
A	0.45	0.55
A1	0.00	0.05
A3	0.13	REF
b	0.12	0.22
D	1.00	BSC
E	1.00	BSC
e	0.35	BSC
L	0.25	0.35
L1	0.30	0.40

RECOMMENDED SOLDERING FOOTPRINT*

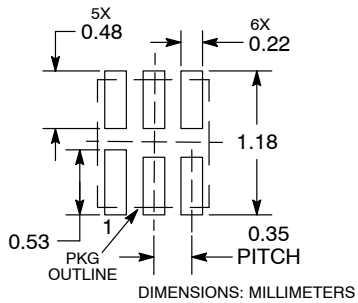

*For additional information on our Pb-Free strategy and soldering details, please download the ON Semiconductor Soldering and Mounting Techniques Reference Manual, SOLDERRM/D.

NL17SV00

PACKAGE DIMENSIONS

SOT-953 CASE 527AE ISSUE E

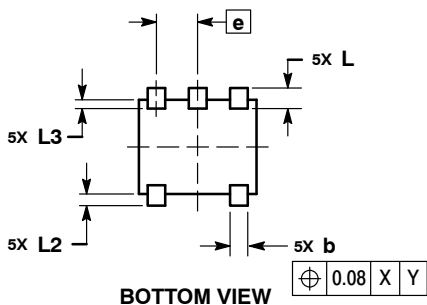
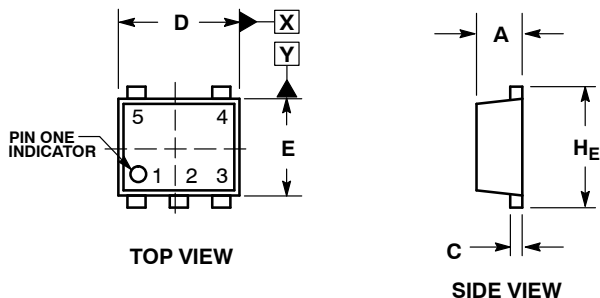

NOTES:

1. DIMENSIONING AND TOLERANCING PER ASME Y14.5M, 1994.
2. CONTROLLING DIMENSION: MILLIMETERS
3. MAXIMUM LEAD THICKNESS INCLUDES LEAD FINISH. MINIMUM LEAD THICKNESS IS THE MINIMUM THICKNESS OF THE BASE MATERIAL.
4. DIMENSIONS D AND E DO NOT INCLUDE MOLD FLASH, PROTRUSIONS, OR GATE BURRS.

DIM	MILLIMETERS		
	MIN	NOM	MAX
A	0.34	0.37	0.40
b	0.10	0.15	0.20
C	0.07	0.12	0.17
D	0.95	1.00	1.05
E	0.75	0.80	0.85
e	0.35 BSC		
HE	0.95	1.00	1.05
L	0.175 REF		
L2	0.05	0.10	0.15
L3	---	---	0.15

SOLDERING FOOTPRINT*

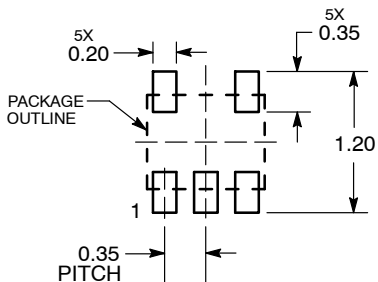

DIMENSIONS: MILLIMETERS

*For additional information on our Pb-Free strategy and soldering details, please download the ON Semiconductor Soldering and Mounting Techniques Reference Manual, SOLDERRM/D.

ON Semiconductor and are trademarks of Semiconductor Components Industries, LLC dba ON Semiconductor or its subsidiaries in the United States and/or other countries. ON Semiconductor owns the rights to a number of patents, trademarks, copyrights, trade secrets, and other intellectual property. A listing of ON Semiconductor's product/patent coverage may be accessed at www.onsemi.com/site/pdf/Patent-Marketing.pdf. ON Semiconductor reserves the right to make changes without further notice to any products herein. ON Semiconductor makes no warranty, representation or guarantee regarding the suitability of its products for any particular purpose, nor does ON Semiconductor assume any liability arising out of the application or use of any product or circuit, and specifically disclaims any and all liability, including without limitation special, consequential or incidental damages. Buyer is responsible for its products and applications using ON Semiconductor products, including compliance with all laws, regulations and safety requirements or standards, regardless of any support or applications information provided by ON Semiconductor. "Typical" parameters which may be provided in ON Semiconductor data sheets and/or specifications can and do vary in different applications and actual performance may vary over time. All operating parameters, including "Typicals" must be validated for each customer application by customer's technical experts. ON Semiconductor does not convey any license under its patent rights nor the rights of others. ON Semiconductor products are not designed, intended, or authorized for use as a critical component in life support systems or any FDA Class 3 medical devices or medical devices with a same or similar classification in a foreign jurisdiction or any devices intended for implantation in the human body. Should Buyer purchase or use ON Semiconductor products for any such unintended or unauthorized application, Buyer shall indemnify and hold ON Semiconductor and its officers, employees, subsidiaries, affiliates, and distributors harmless against all claims, costs, damages, and expenses, and reasonable attorney fees arising out of, directly or indirectly, any claim of personal injury or death associated with such unintended or unauthorized use, even if such claim alleges that ON Semiconductor was negligent regarding the design or manufacture of the part. ON Semiconductor is an Equal Opportunity/Affirmative Action Employer. This literature is subject to all applicable copyright laws and is not for resale in any manner.

PUBLICATION ORDERING INFORMATION

LITERATURE FULFILLMENT:
Email Requests to: orderlit@onsemi.com

TECHNICAL SUPPORT
North American Technical Support:
Voice Mail: 1 800-282-9855 Toll Free USA/Canada
Phone: 011 421 33 790 2910

Europe, Middle East and Africa Technical Support:
Phone: 00421 33 790 2910
For additional information, please contact your local Sales Representative