

NL17SZ07

Single Non-Inverting Buffer with Open Drain Output

The NL17SZ07 is a high performance single non-inverting buffer with open drain outputs operating from a 1.65 to 5.5 V supply.

The Output stage is open drain with Over Voltage Tolerance. This allows the NL17SZ07 to be used to interface 5.0 V circuits to circuits of any voltage between 0 and +7.0 V.

Features

- Tiny SOT-353, SOT-553 and SOT-953 Packages
- Extremely High Speed: t_{PD} 2.5 ns (typical) at $V_{CC} = 5$ V
- Designed for 1.65 V to 5.5 V V_{CC} Operation, CMOS Compatible
- Over Voltage Tolerant Inputs V_{IN} may be Between 0 and 7.0 V for V_{CC} Between 0.5 and 5.5 V
- TTL Compatible – Interface Capability with 5.0 V TTL Logic with $V_{CC} = 2.7$ V to 3.6 V
- LVCMOS Compatible
- 24 mA Output Sink Capability, Pullup may be between 0 and 7.0 V
- Near Zero Static Supply Current Substantially Reduces System Power Requirements
- Chip Complexity: FET = 20
- These Devices are Pb-Free, Halogen Free/BFR Free and are RoHS Compliant

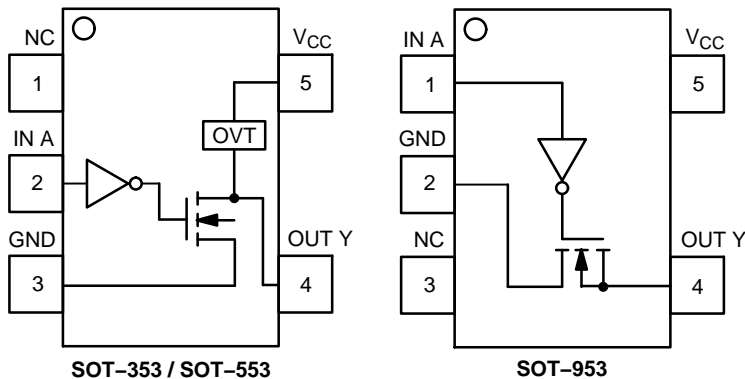

Figure 1. Pinout

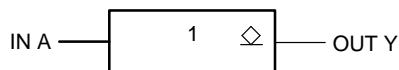

Figure 2. Logic Symbol



ON Semiconductor®

www.onsemi.com

MARKING DIAGRAMS

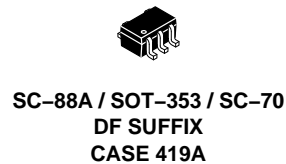

SOT-553
XV5 SUFFIX
CASE 463B

L7 = Device Code
M = Date Code*
▪ = Pb-Free Package

(Note: Microdot may be in either location)
*Date Code orientation and/or position may vary depending upon manufacturing location.



6 = Specific Device Code
M = Month Code

ORDERING INFORMATION

See detailed ordering and shipping information in the package dimensions section on page 5 of this data sheet.

NL17SZ07

PIN ASSIGNMENT (SOT-353 / SOT-553)

Pin	Function
1	NC
2	IN A
3	GND
4	OUT Y
5	V _{CC}

PIN ASSIGNMENT (SOT-953)

Pin	Function
1	IN A
2	GND
3	NC
4	OUT Y
5	V _{CC}

FUNCTION TABLE

Input	Output
A	Y
L	L
H	Z

MAXIMUM RATINGS

Symbol	Characteristics	Value	Unit	
V _{CC}	DC Supply Voltage	-0.5 to +7.0	V	
V _I	DC Input Voltage	-0.5 ≤ V _I ≤ +7.0	V	
V _O	DC Output Voltage (SOT-953 Package) (Note 1)	-0.5 to V _{CC} + 0.5	V	
	DC Output Voltage (SOT-353 / SOT-553 Packages) Active Mode, LOW State (Note 1)	-0.5 to V _{CC} + 0.5		
	DC Output Voltage (SOT-353 / SOT-553 Packages) Tri-State Mode Power-Down Mode (V _{CC} = 0 V)	-0.5 to +7.0 -0.5 to +7.0		
I _{OK}	DC Output Diode Current (SOT-953 Package) V _O < GND, V _O > V _{CC}	±50	mA	
	DC Output Diode Current (SOT-353 / SOT-553 Packages) V _O < GND	-50		
I _{IK}	DC Input Diode Current V _I < GND	-50	mA	
I _O	DC Output Sink Current	±50	mA	
I _{CC}	DC Supply Current per Supply Pin	±100	mA	
I _{GND}	DC Ground Current per Ground Pin	±100	mA	
T _{STG}	Storage Temperature Range	-65 to +150	°C	
P _D	Power Dissipation in Still Air	SOT-353	186	mW
		SOT-553	135	
θ _{JA}	Thermal Resistance	SOT-353	350	°C/W
		SOT-553	496	
T _L	Lead Temperature, 1 mm from Case for 10 Seconds	260	°C	
T _J	Junction Temperature Under Bias	+150	°C	
I _{Latch-Up}	Latch-Up Performance Above V _{CC} and Below GND at 85°C (Note 5)	±100	mA	
MSL	Moisture Sensitivity	Level 1		
F _R	Flammability Rating Oxygen Index: 28 to 34	UL 94 V-0 @ 0.125 in		
ESD	ESD Classification	Human Body Model (Note 3)	2000	V
		Machine Model (Note 4)	200	V
		Charged Device Model (Note 5)	N/A	

Stresses exceeding those listed in the Maximum Ratings table may damage the device. If any of these limits are exceeded, device functionality should not be assumed, damage may occur and reliability may be affected.

1. I_O absolute maximum rating must be observed.
2. Tested to EIA/JESD22-A114-A, rated to EIA/JESD22-A114-B.
3. Tested to EIA/JESD22-A115-A, rated to EIA/JESD22-A115-A.
4. Tested to JESD22-C101-A.
5. Tested to EIA/JESD78.

NL17SZ07

RECOMMENDED OPERATING CONDITIONS

Symbol	Parameter	Min	Max	Unit	
V _{CC}	Supply Voltage	Operating	1.65	5.5	V
		Data Retention Only	1.5	5.5	
V _I	Input Voltage	0	5.5	V	
V _O	Output Voltage (SOT-953 Package)	0	V _{CC}	V	
	Output Voltage (SOT-353 / SOT-553 Packages)	Active Mode, LOW State	0		V _{CC}
		Tri-State Mode	0		5.5
	Power-Down Mode (V _{CC} = 0 V)	0	5.5		
T _A	Operating Free-Air Temperature	-55	+125	°C	
Δt/ΔV	Input Transition Rise or Fall Rate	V _{CC} = 2.5 V ±0.2 V	0	20	ns/V
		V _{CC} = 3.0 V ±0.3 V	0	10	
		V _{CC} = 5.0 V ±0.5 V	0	5	

Functional operation above the stresses listed in the Recommended Operating Ranges is not implied. Extended exposure to stresses beyond the Recommended Operating Ranges limits may affect device reliability.

DC ELECTRICAL CHARACTERISTICS

Symbol	Parameter	Condition	V _{CC} (V)	T _A = 25°C			-55°C ≤ T _A ≤ 125°C		Unit
				Min	Typ	Max	Min	Max	
V _{IH}	High-Level Input Voltage		1.65 to 1.95 2.3 to 5.5	0.75 V _{CC} 0.7 V _{CC}			0.75 V _{CC} 0.7 V _{CC}		V
V _{IL}	Low-Level Input Voltage		1.65 to 1.95 2.3 to 5.5			0.25 V _{CC} 0.3 V _{CC}		0.25 V _{CC} 0.3 V _{CC}	V
I _{LKG}	Z-State Output Leakage Current	V _{IN} = V _{IH} V _{OUT} = V _{CC} or GND	2.3 to 5.5			±5.0		±10.0	μA
V _{OL}	Low-Level Output Voltage V _{IN} = V _{IL}	I _{OL} = 100 μA	1.65 to 5.5		0.0	0.1		0.1	V
		I _{OL} = 4 mA	1.65		0.08	0.24		0.24	
		I _{OL} = 8 mA	2.3		0.20	0.3		0.3	
		I _{OL} = 12 mA	2.7		0.22	0.4		0.4	
		I _{OL} = 16 mA	3.0		0.28	0.4		0.4	
		I _{OL} = 24 mA	3.0		0.38	0.55		0.55	
		I _{OL} = 32 mA	4.5		0.42	0.55		0.55	
I _{IN}	Input Leakage Current	V _{IN} = 5.5 V or GND	0 to 5.5			±0.1		±1.0	μA
I _{OFF}	Power Off Leakage Current (SOT-353/SOT-553 Packages)	V _{IN} = 5.5 V or V _{OUT} = 5.5 V	0			1		10	μA
I _{CC}	Quiescent Supply Current	V _{IN} = 5.5 V or GND	5.5			1		10	μA
I _{CCT}	Quiescent Supply Current	V _{IN} = 3.0 V	3.6			10		100	μA

Product parametric performance is indicated in the Electrical Characteristics for the listed test conditions, unless otherwise noted. Product performance may not be indicated by the Electrical Characteristics if operated under different conditions.

NL17SZ07

AC ELECTRICAL CHARACTERISTICS $t_R = t_F = 2.5 \text{ ns}$; $C_L = 50 \text{ pF}$; $R_L = 500 \Omega$

Symbol	Parameter	Condition	V_{CC} (V)	$T_A = 25^\circ\text{C}$			$-55^\circ\text{C} \leq T_A \leq 125^\circ\text{C}$		Unit
				Min	Typ	Max	Min	Max	
t_{PZL}	Propagation Delay (Figure 3 and 4)	$R_L = R_1 = 500 \Omega$, $C_L = 50 \text{ pF}$	1.8 ± 0.15	0.8	5.3	11.6	0.8	12.0	ns
			2.5 ± 0.2	1.2	3.7	5.8	1.2	6.4	
			3.3 ± 0.3	0.8	2.9	4.4	0.8	4.8	
			5.0 ± 0.5	0.5	2.3	3.5	0.5	3.9	
t_{PLZ}	Propagation Delay (Figure 3 and 4)	$R_L = R_1 = 500 \Omega$, $C_L = 50 \text{ pF}$	1.8 ± 0.15	0.8	5.3	11.6	0.8	1.20	ns
			2.5 ± 0.2	1.2	2.8	5.8	1.2	6.4	
			3.3 ± 0.3	0.8	2.1	4.4	0.8	4.8	
			5.0 ± 0.5	0.5	1.4	3.5	0.5	3.9	

CAPACITIVE CHARACTERISTICS

Symbol	Parameter	Condition	Typical	Unit
C_{IN}	Input Capacitance	$V_{CC} = 5.5 \text{ V}$, $V_I = 0 \text{ V}$ or V_{CC}	> 2.5	pF
C_{OUT}	Output Capacitance	$V_{CC} = 5.5 \text{ V}$, $V_I = 0 \text{ V}$ or V_{CC}	4.0	pF
C_{PD}	Power Dissipation Capacitance (Note 6)	10 MHz, $V_{CC} = 5.5 \text{ V}$, $V_I = 0 \text{ V}$ or V_{CC}	4.0	pF

6. C_{PD} is defined as the value of the internal equivalent capacitance which is calculated from the operating current consumption without load. Average operating current can be obtained by the equation: $I_{CC(OPER)} = C_{PD} \cdot V_{CC} \cdot f_{in} + I_{CC}$. C_{PD} is used to determine the no-load dynamic power consumption; $P_D = C_{PD} \cdot V_{CC}^2 \cdot f_{in} + I_{CC} \cdot V_{CC}$.

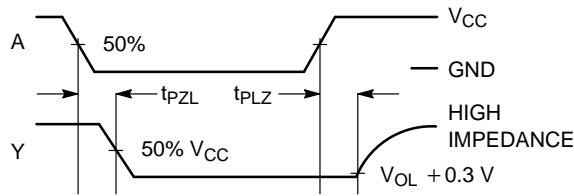

Figure 3. Switching Waveforms

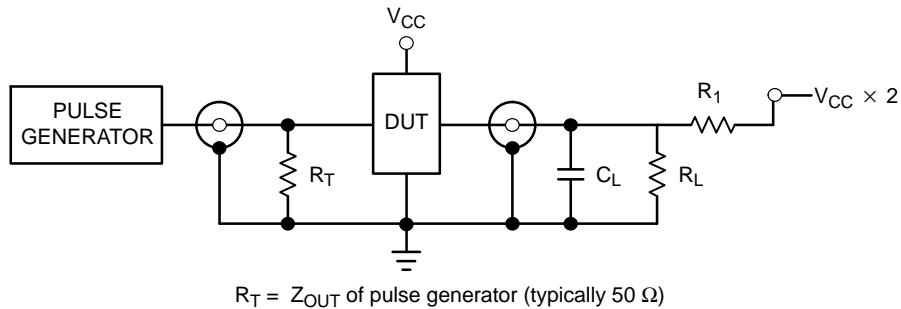

Figure 4. Test Circuit

NL17SZ07

DEVICE ORDERING INFORMATION

Device	Package	Shipping†
NL17SZ07DFT2G	SOT-353/SC70-5/SC-88A (Pb-Free)	3000 / Tape & Reel
NL17SZ07XV5T2G	SOT-553 (Pb-Free)	4000 / Tape & Reel
NL17SZ07P5T5G	SOT-953 (Pb-Free)	8000 / Tape & Reel

†For information on tape and reel specifications, including part orientation and tape sizes, please refer to our Tape and Reel Packaging Specifications Brochure, BRD8011/D.

NL17SZ07

PACKAGE DIMENSIONS

SC-88A (SC-70-5/SOT-353)
CASE 419A-02
ISSUE L

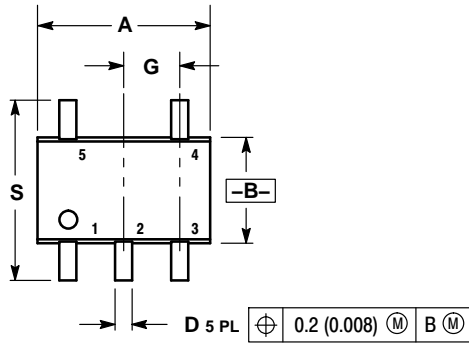

- NOTES:
1. DIMENSIONING AND TOLERANCING PER ANSI Y14.5M, 1982.
 2. CONTROLLING DIMENSION: INCH.
 3. 419A-01 OBSOLETE. NEW STANDARD 419A-02.
 4. DIMENSIONS A AND B DO NOT INCLUDE MOLD FLASH, PROTRUSIONS, OR GATE BURRS.

DIM	INCHES		MILLIMETERS	
	MIN	MAX	MIN	MAX
A	0.071	0.087	1.80	2.20
B	0.045	0.053	1.15	1.35
C	0.031	0.043	0.80	1.10
D	0.004	0.012	0.10	0.30
G	0.026 BSC		0.65 BSC	
H	---	0.004	---	0.10
J	0.004	0.010	0.10	0.25
K	0.004	0.012	0.10	0.30
N	0.008 REF		0.20 REF	
S	0.079	0.087	2.00	2.20

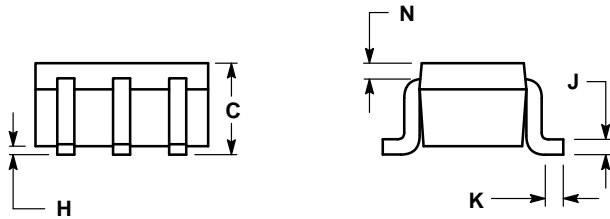

SOLDER FOOTPRINT*

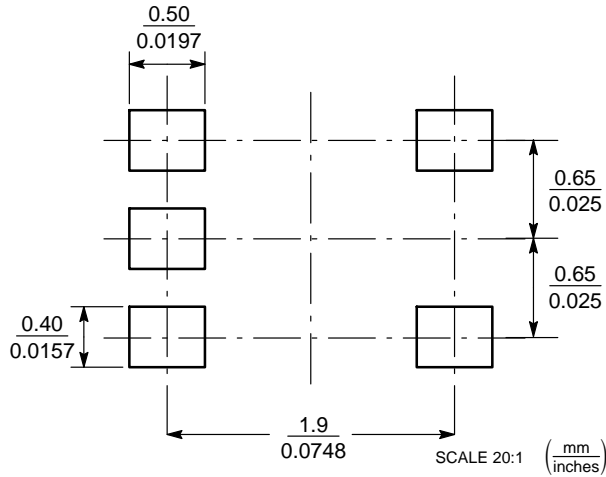

*For additional information on our Pb-Free strategy and soldering details, please download the ON Semiconductor Soldering and Mounting Techniques Reference Manual, SOLDERRM/D.

NL17SZ07

PACKAGE DIMENSIONS

SOT-553
XV5 SUFFIX
CASE 463B
ISSUE C

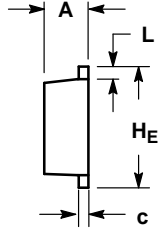
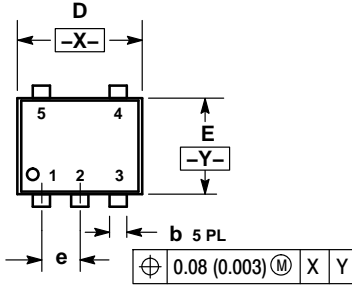

NOTES:

1. DIMENSIONING AND TOLERANCING PER ANSI Y14.5M, 1982.
2. CONTROLLING DIMENSION: MILLIMETERS
3. MAXIMUM LEAD THICKNESS INCLUDES LEAD FINISH THICKNESS. MINIMUM LEAD THICKNESS IS THE MINIMUM THICKNESS OF BASE MATERIAL.

DIM	MILLIMETERS			INCHES		
	MIN	NOM	MAX	MIN	NOM	MAX
A	0.50	0.55	0.60	0.020	0.022	0.024
b	0.17	0.22	0.27	0.007	0.009	0.011
c	0.08	0.13	0.18	0.003	0.005	0.007
D	1.55	1.60	1.65	0.061	0.063	0.065
E	1.15	1.20	1.25	0.045	0.047	0.049
e	0.50 BSC			0.020 BSC		
L	0.10	0.20	0.30	0.004	0.008	0.012
HE	1.55	1.60	1.65	0.061	0.063	0.065

SOLDERING FOOTPRINT*

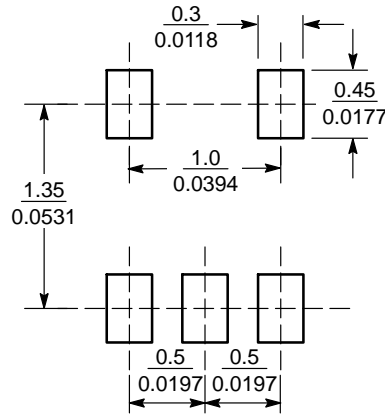

SCALE 20:1 $\left(\frac{\text{mm}}{\text{inches}} \right)$

*For additional information on our Pb-Free strategy and soldering details, please download the ON Semiconductor Soldering and Mounting Techniques Reference Manual, SOLDERRM/D.

NL17SZ07

PACKAGE DIMENSIONS

SOT-953 CASE 527AE ISSUE E

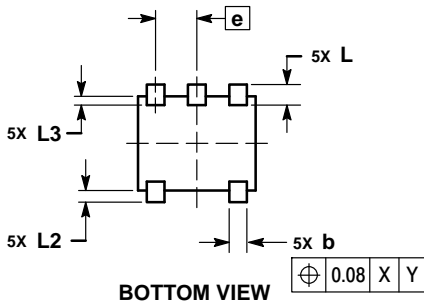
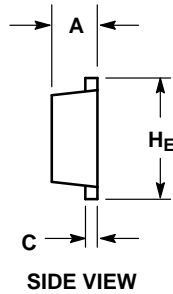
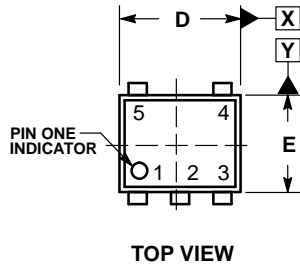

NOTES:

1. DIMENSIONING AND TOLERANCING PER ASME Y14.5M, 1994.
2. CONTROLLING DIMENSION: MILLIMETERS
3. MAXIMUM LEAD THICKNESS INCLUDES LEAD FINISH. MINIMUM LEAD THICKNESS IS THE MINIMUM THICKNESS OF THE BASE MATERIAL.
4. DIMENSIONS D AND E DO NOT INCLUDE MOLD FLASH, PROTRUSIONS, OR GATE BURRS.

DIM	MILLIMETERS		
	MIN	NOM	MAX
A	0.34	0.37	0.40
b	0.10	0.15	0.20
C	0.07	0.12	0.17
D	0.95	1.00	1.05
E	0.75	0.80	0.85
e	0.35 BSC		
H _e	0.95	1.00	1.05
L	0.175 REF		
L2	0.05	0.10	0.15
L3	---	---	0.15

SOLDERING FOOTPRINT*

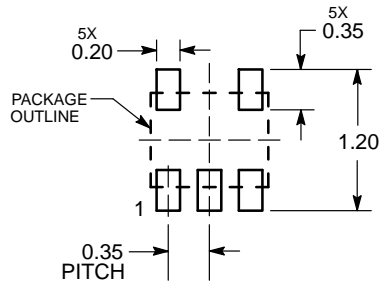

DIMENSIONS: MILLIMETERS

*For additional information on our Pb-Free strategy and soldering details, please download the ON Semiconductor Soldering and Mounting Techniques Reference Manual, SOLDERRM/D.

ON Semiconductor and the are registered trademarks of Semiconductor Components Industries, LLC (SCILLC) or its subsidiaries in the United States and/or other countries. SCILLC owns the rights to a number of patents, trademarks, copyrights, trade secrets, and other intellectual property. A listing of SCILLC's product/patent coverage may be accessed at www.onsemi.com/site/pdf/Patent-Marketing.pdf. SCILLC reserves the right to make changes without further notice to any products herein. SCILLC makes no warranty, representation or guarantee regarding the suitability of its products for any particular purpose, nor does SCILLC assume any liability arising out of the application or use of any product or circuit, and specifically disclaims any and all liability, including without limitation special, consequential or incidental damages. "Typical" parameters which may be provided in SCILLC data sheets and/or specifications can and do vary in different applications and actual performance may vary over time. All operating parameters, including "Typicals" must be validated for each customer application by customer's technical experts. SCILLC does not convey any license under its patent rights nor the rights of others. SCILLC products are not designed, intended, or authorized for use as components in systems intended for surgical implant into the body, or other applications intended to support or sustain life, or for any other application in which the failure of the SCILLC product could create a situation where personal injury or death may occur. Should Buyer purchase or use SCILLC products for any such unintended or unauthorized application, Buyer shall indemnify and hold SCILLC and its officers, employees, subsidiaries, affiliates, and distributors harmless against all claims, costs, damages, and expenses, and reasonable attorney fees arising out of, directly or indirectly, any claim of personal injury or death associated with such unintended or unauthorized use, even if such claim alleges that SCILLC was negligent regarding the design or manufacture of the part. SCILLC is an Equal Opportunity/Affirmative Action Employer. This literature is subject to all applicable copyright laws and is not for resale in any manner.

PUBLICATION ORDERING INFORMATION

LITERATURE FULFILLMENT:

Literature Distribution Center for ON Semiconductor
19521 E. 32nd Pkwy, Aurora, Colorado 80011 USA
Phone: 303-675-2175 or 800-344-3860 Toll Free USA/Canada
Fax: 303-675-2176 or 800-344-3867 Toll Free USA/Canada
Email: orderlit@onsemi.com

N. American Technical Support: 800-282-9855 Toll Free
USA/Canada
Europe, Middle East and Africa Technical Support:
Phone: 421 33 790 2910
Japan Customer Focus Center
Phone: 81-3-5817-1050

ON Semiconductor Website: www.onsemi.com
Order Literature: <http://www.onsemi.com/orderlit>

For additional information, please contact your local Sales Representative