

NICHIA CORPORATION

SPECIFICATIONS FOR RED STANDARD LED

NLSR06S01

- LED reference standard with temperature control unit for luminous flux and radiant flux calibration

SPECIFICATIONS

(1) Absolute Maximum Ratings

Item	Symbol	Absolute Maximum Rating	Unit
Forward Current	I_F 300		mA
Allowable Reverse Current	I_R 50		mA
Operating Temperature	T_{opr}	20 ~ 30	°C
Storage Temperature	T_{stg}	0 ~ 40	°C
Platinum Resistance Temperature Device (RTD) Current	I_{pt} 2		mA
Peltier Device Current	I_{pel}	-1 ~ 1	A
Peltier Device Voltage	V_{pel}	-3.2 ~ 3.2	V

* Absolute maximum ratings at $T_A = 25^\circ\text{C}$.

(2) Initial Electrical/Optical Characteristics

Item	Symbol	Condition	Typ.	Unit
Forward Voltage	V_F	$T_{pt} = 45^\circ\text{C}, I_F = 240 \text{ mA}$	2.2	V
Luminous Flux	Φ_v	$T_{pt} = 45^\circ\text{C}, I_F = 240 \text{ mA}$	16	lm
Radiant flux	Φ_e	$T_{pt} = 45^\circ\text{C}, I_F = 240 \text{ mA}$	105	mW
Chromaticity Coordinate	x	$T_{pt} = 45^\circ\text{C}, I_F = 240 \text{ mA}$	0.70	-
	y	$T_{pt} = 45^\circ\text{C}, I_F = 240 \text{ mA}$	0.30	-

* Characteristics at $T_A = 25^\circ\text{C}$.

* The typical values of luminous flux and radiant flux are traceable to the CIE 127:2007-compliant national standards.

* The chromaticity coordinates are derived from the CIE 1931 Chromaticity Diagram.

* Platinum RTD temperature (T_{pt}) must be controlled between 50°C and 60°C .

* The LED incorporated into the socket was characterized.

* The product seasoned for 200 hours at $T_A = 25^\circ\text{C}, I_F = 240 \text{ mA}$ was characterized.

(3) Lumen Maintenance

* Guaranteed maximum fluctuation of luminous flux is $\pm 3\%$ of the initial value up to 100 hours of continuous operation at $T_A = 25^\circ\text{C}, T_{pt} = 45^\circ\text{C} (\pm 0.03^\circ\text{C})$, and $I_F = 240 \text{ mA} (\pm 0.1\%)$.

DIRECTIONS FOR USE

(1) Auxiliary Equipment and System Requirements

- The following figure shows how the Luminous Flux Standard LED is connected.

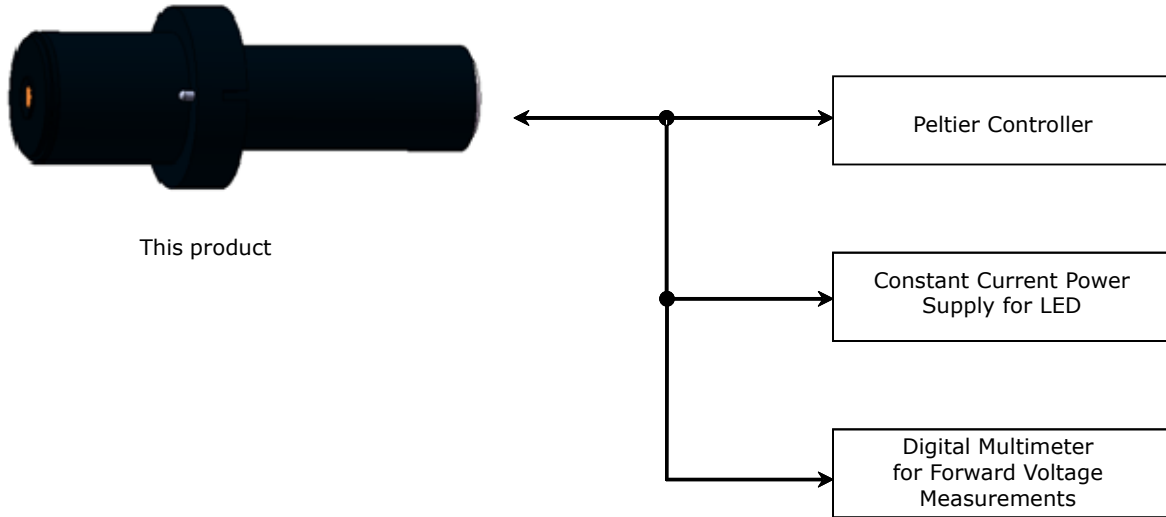

Recommended specifications for the peripheral equipment

Peltier Controller	PID Controller Temperature measurement accuracy of $\pm 0.03^{\circ}\text{C}$.
Constant Current Power Supply for LED	Drive current accuracy: $\leq 0.1\%$ of the set current
Digital Multimeter for Forward Voltage Measurements	Input impedance: $\geq 1\ \text{G}\Omega$

(2) Installation

- The following figure shows how the product should be held by a holder.

Example 1:

(Held by the part with 25 mm diameter)

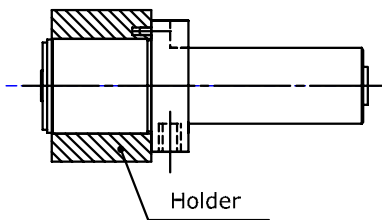

Example 2:

(Held by the part with 20 mm diameter)

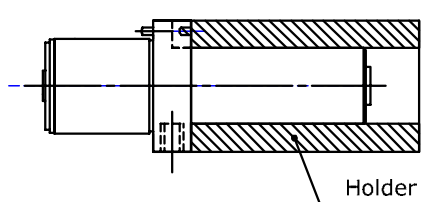

(3) Measurement

- The product should be measured when luminous flux or radiant flux has stabilized after the start of temperature control and constant current drive.

Typically, this product will be stable and ready to be used for calibration within 1 to 3 minutes.

Please refer to "STABILITY" on the following page for the characteristics during the first 5 minutes after the LED starts emission.

OUTLINE DIMENSIONS

NLSx06S01

管理番号 No. STS-DA5-0014

(単位 Unit: mm, 公差 Tolerance: ±0.2)

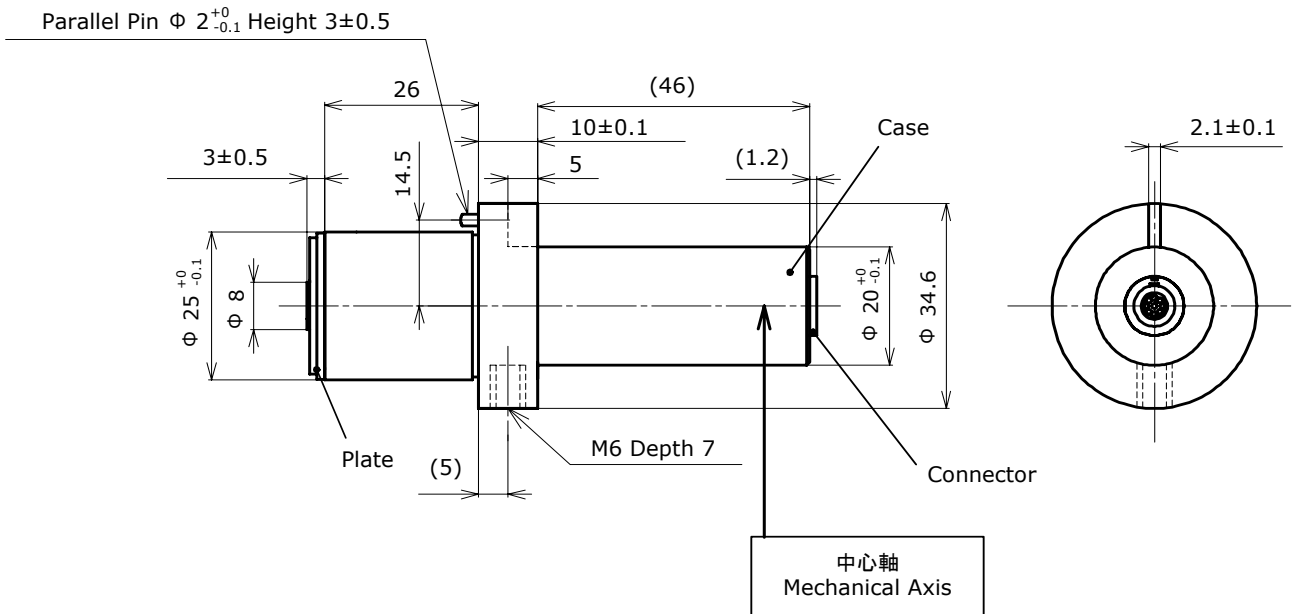

項目 Item	内容 Description	数量 Quantity
コネクタ Connector	Part No.: EGJ.0B.309.CLA (from LEMO JAPAN Ltd.)	1
ケース Case	材質: アルミニウム Material: Aluminum	1
プレート Plate	材質: 樹脂 Material: POM	1

型番 NICHIA Part Number シリアル番号 Serial Number

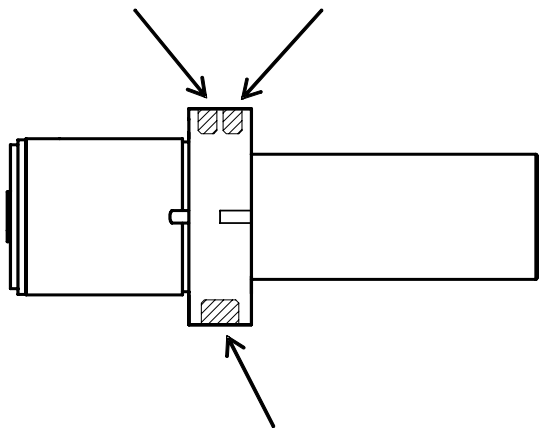

ロゴマーク NICHIA LED Mark

型番 NICHIA Part Number
NLSx06S01
x - 発光色 (例 W: 白色)
x - Color (Example W: White)

シリアル番号 Serial Number
xxxxx

ロゴマーク NICHIA LED Mark



WIRING CONNECTION

NLSx06S01
管理番号 No. STS-DA5-0015



矢印方向から見たコネクタ図は以下を参照して下さい。
Refer to the following illustration for the connector pin numbering
(viewed from direction of the arrow).

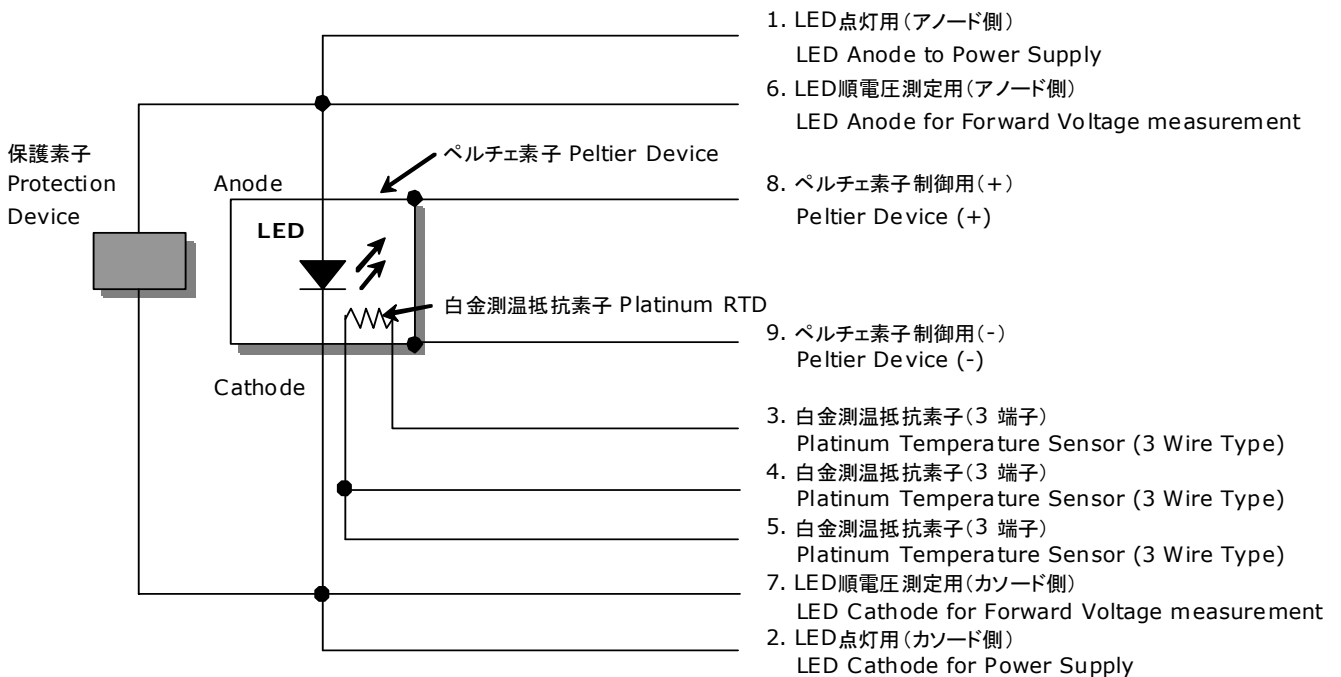
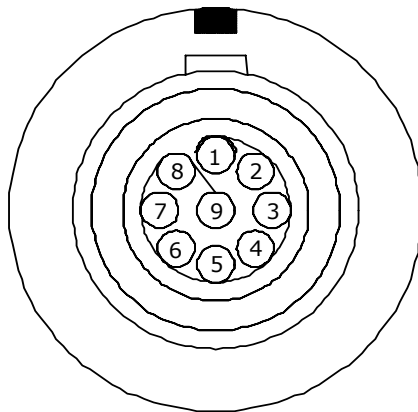

PACKAGING

NLSx06S01
管理番号 No. STS-DA5-0016

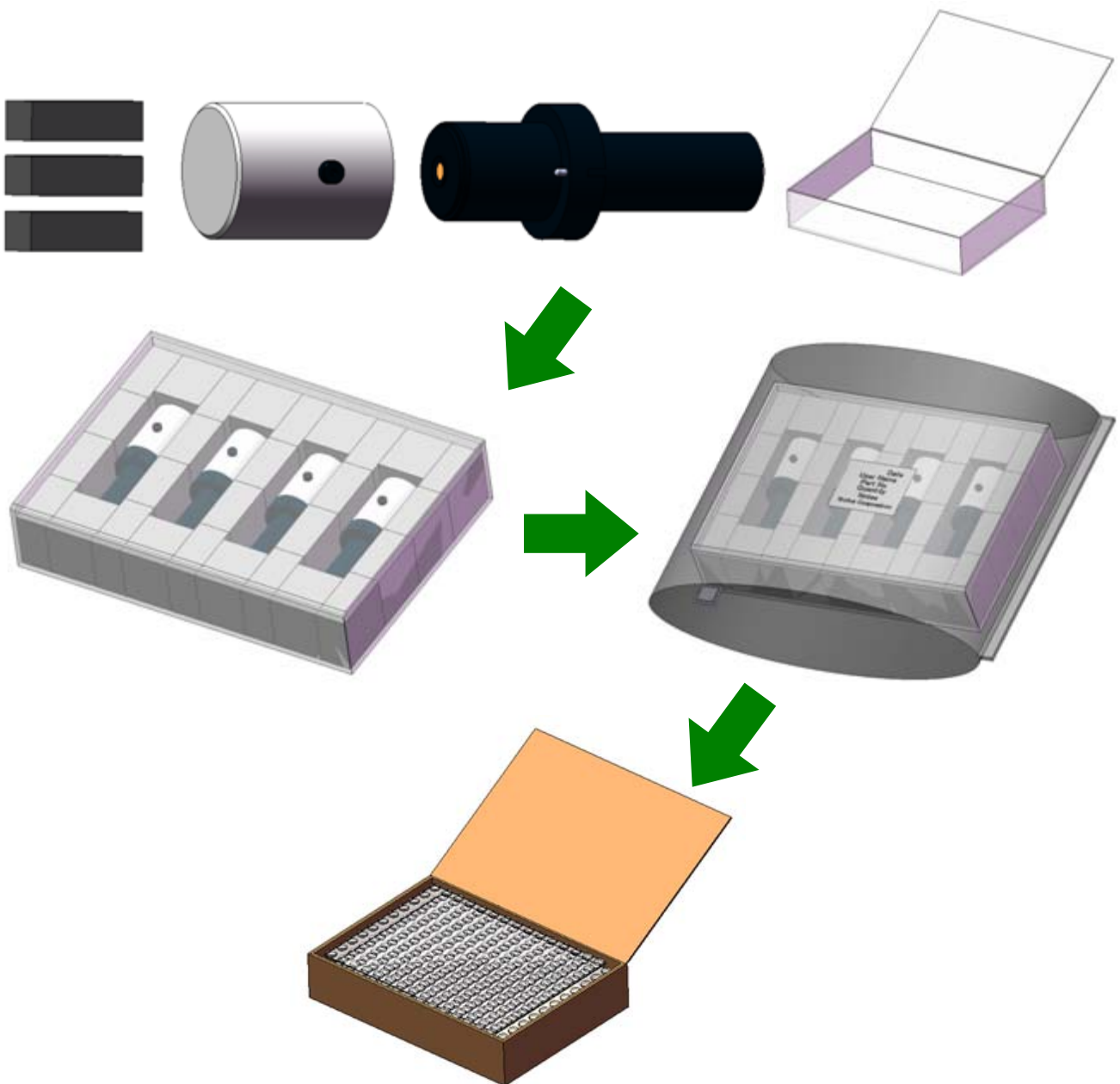

- * 製品、キャップ、緩衝ウレタンをプラスチックケースに入れます。
The capped products are placed in a urethane-filled plastic case.
- * プラスチックケースをシリカゲルとともにアルミ防湿袋に入れ、熱シールにより封をします
The plastic case and desiccant (silica gel) are placed in a moisture-proof foil bag and then heat-sealed.
- * 製品を入れたアルミ防湿袋をプチシートでくるみ、段ボール箱に梱包します
The moisture proof foil bag is covered with bubble-wrap and the bubble wrap is placed in a cardboard box.
- * 段ボール箱内に空きスペースがなくなるまでプチシートを重ね、最後に段ボール箱のふたをガムテープで止めます
Extra bubble-wrap is filled in the empty space of the box. Then the box is sealed with packing tape.
- * プラスチックケースには出荷先、型名 数量 備考を明記したラベルを貼りつけます。
A label specifying "Customer Name, NICHIA Part No., Quantity and Notes" is attached to the plastic case.

OPTICAL CHARACTERISTICS

* 本特性は参考です。
All characteristics shown are for reference only and are not guaranteed.

NLSR06S01
管理番号 No. STS-DA5-0021

発光スペクトル Spectrum

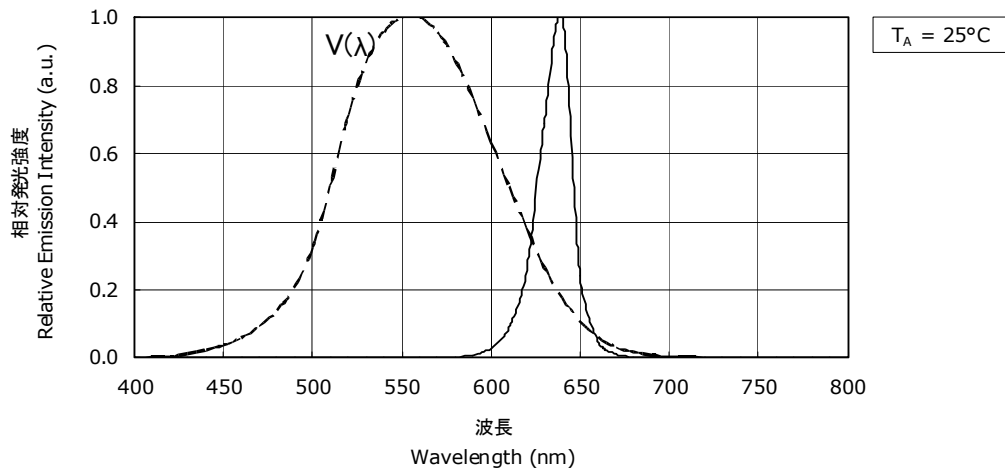

指向特性 Directivity

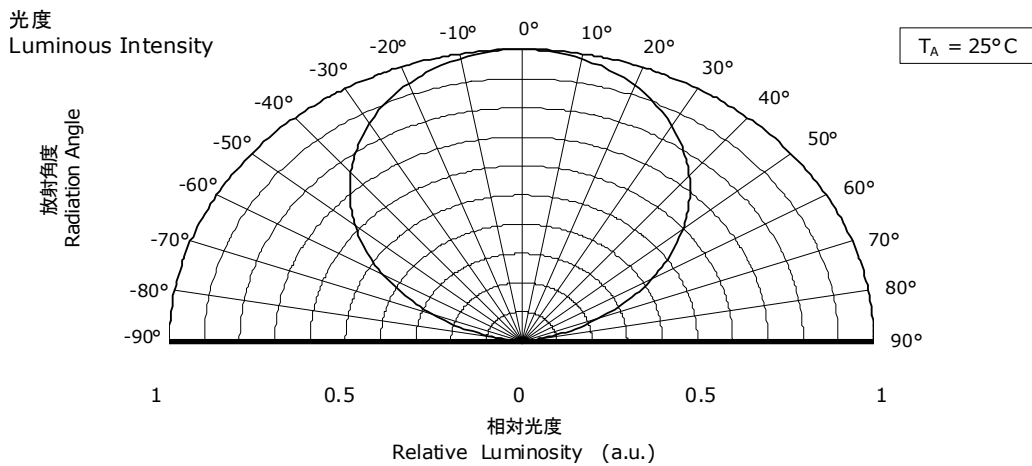

色度 Chromaticity Coordinate

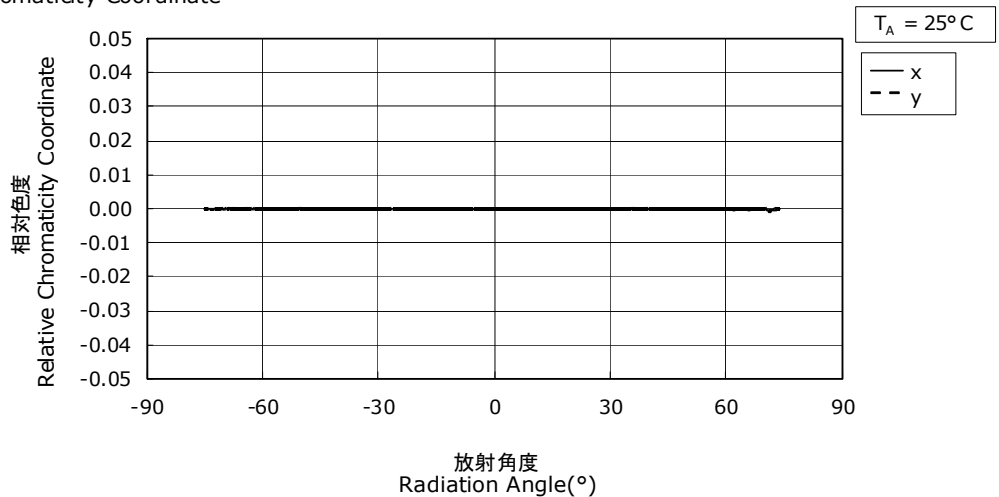

* 標準LEDに取り付けられた白金測温抵抗素子の温度が45°Cなるように温度コントロールしたときの特性です($I_F = 240\text{ mA}$)。

These characteristics are measured at $I_F = 240\text{ mA}$ and $T_{pt} = 45^\circ\text{C}$.

* ペルチェコントローラーの温度制御安定度は $\pm 0.03^\circ\text{C}$ です(メーカー仕様値)。

The Stability of Peltier Controller is $\pm 0.03^\circ\text{C}$ (data from manufacturer specification).

STABILITY

* 本特性は参考です。
All characteristics shown are for reference only and are not guaranteed.

NLSR06S01
管理番号 No. STS-DA5-0022

点灯時間 - 相对順電圧特性
Relative Forward Voltage
Over Time

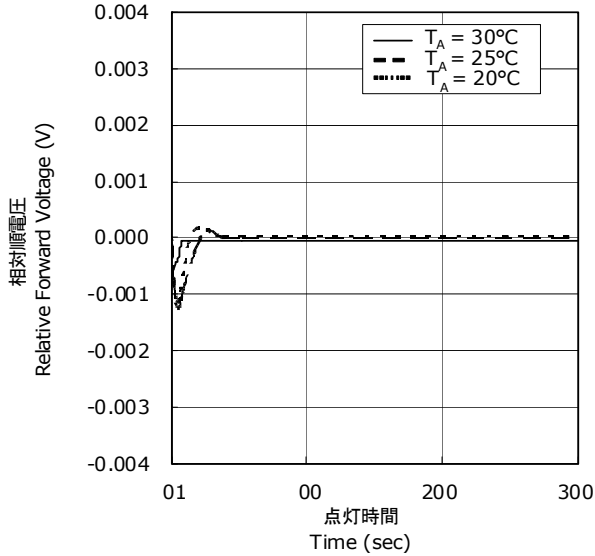

点灯時間 - 相对光束特性
Relative Luminous Flux
Over Time

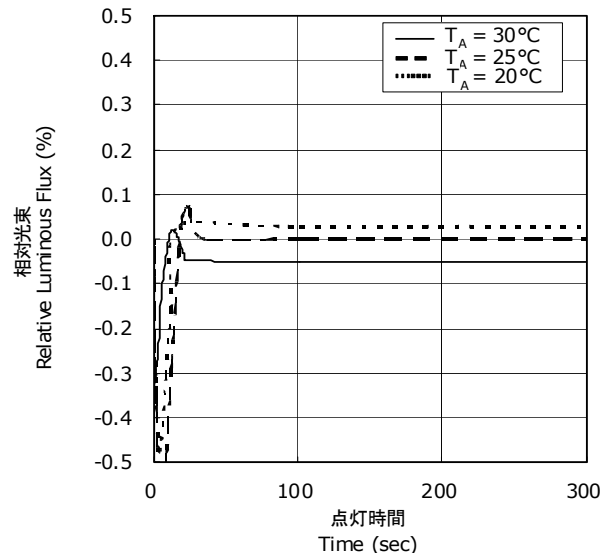

点灯時間 - 相对色度 x特性
Relative x Coordinate
Over Time

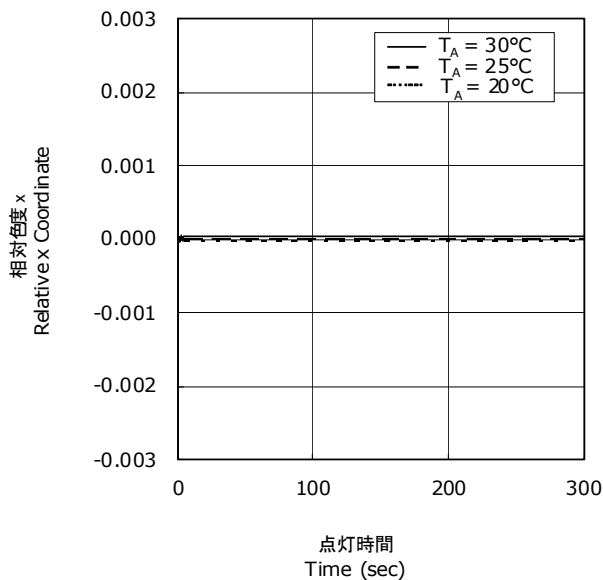

点灯時間 - 相对色度 y特性
Relative y Coordinate
Over Time

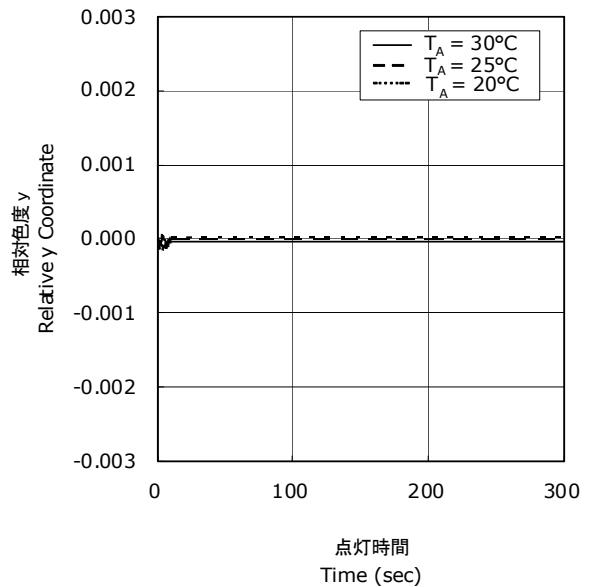

* 標準LEDに取り付けられた白金測温抵抗素子の温度が45°Cなるように温度コントロールしたときの特性です ($I_F = 240 \text{ mA}$)。

These characteristics are measured at $I_F = 240 \text{ mA}$ and $T_{pt} = 45^\circ\text{C}$.

* ペルチェコントローラーの温度制御安定度は $\pm 0.03^\circ\text{C}$ です(メーカー仕様値)。

The Stability of Peltier Controller is $\pm 0.03^\circ\text{C}$ (data from manufacturer specification).

* 点灯時間-相对順電圧特性、点灯時間-相对光束特性、点灯時間-相对色度x特性、点灯時間-相对色度y特性は、 $T_A = 25^\circ\text{C}$ 、LED点灯300sec後の値を基準としています。

In the above graphs, the value at 300 seconds of the curve of $T_A = 25^\circ\text{C}$ was set as the reference point.

CAUTIONS

(1) Storage

- The products should be stored in an air tight container with desiccant (silica gel) at 30°C or less and 70% RH or less.
- To avoid condensation, the products must not be stored in the areas where temperature and humidity fluctuate greatly.
- The LED incorporated in the product is silver plated.

Customer is advised to store properly the products in controlled ambient as exposure to a corrosive environment might cause the plated metal parts of the product to tarnish, which might leads to adverse effects on optical characteristics.

(2) Handling Precautions

- The LED used in this product employs silicone as encapsulating resin. Do not touch the encapsulant as the encapsulant is soft and easy to attract dirt. Failure to comply might have adverse effects on characteristics, and, in the worst case scenario, lead to catastrophic failure.
- Do not expose the product to shock. Failure to comply might affect on its characteristics.

(3) Electrostatic Discharge (ESD)

- The products are sensitive to static electricity or surge voltage. An ESD event may damage its die or reduce its reliability performance. When handling the products, measures against electro static discharge, including the followings, are strongly recommended.
 - Eliminating the charge;
 - Wrist strap, ESD footwear and garments, ESD floors
 - Grounding the equipment and tools at workstation
 - ESD table/shelf mat (conductive materials)
- Proper grounding techniques are required for all devices, equipment and machinery used in the assembly of the products.
- If tools or equipment contain insulating materials, such as glass or plastic, proper measures against electro static discharge, including the followings, are strongly recommended.
 - Dissipating the charge with conductive materials
 - Preventing the charge generation with moisture
 - Neutralizing the charge with ionizers

(4) Eye Safety

- The International Electrical Commission (IEC) published in 2006, IEC 62471:2006 Photobiological safety of lamps and lamp systems which includes LEDs within its scope. Meanwhile LEDs were removed from the scope of the IEC 60825-1:2007 laser safety standard, the 2001 edition of which included LED sources within its scope. However, keep it mind that some countries and regions have adopted standards based on the IEC laser safety standard IEC 60825-1:2001 which includes LEDs within its scope. Following IEC 62471:2006, most of Nichia LEDs can be classified as belonging to either Exempt Group or Risk Group 1. Especially a high-power LED, that emits light containing blue wavelengths, may be in Risk Group 2. Great care should be taken when viewing directly the LED driven at high current or the LED with optical instruments, which greatly increase the hazard to your eyes.
- Viewing a flashing light may cause eye discomfort. When incorporating the LED into your product, precaution should be taken to avoid adverse effect on human body caused by the light stimulus.

(5) Others

- This product is designed to be used for calibration. Do not use this product for any other purposes or other applications.
- The customer shall not reverse engineer by disassembling or analysis of the LEDs without having prior written consent from Nichia. When defective LEDs are found, the customer shall inform Nichia directly before disassembling or analysis.
- When a customer purchases this product, the customer and Nichia shall agree the official specification of the supplied products.
- The appearance and specifications of the product may be modified for improvement without notice.