

NLSV1T240

1-Bit Dual-Supply Inverting Level Translator

The NLSV1T240 is a 1-bit configurable dual-supply voltage level translator. The input A_n and output B_n ports are designed to track two different power supply rails, V_{CCA} and V_{CCB} respectively. Both supply rails are configurable from 0.9 V to 4.5 V allowing universal low-voltage translation from the input A_n to the output B_n port.

Features

- Wide V_{CCA} and V_{CCB} Operating Range: 0.9 V to 4.5 V
- High-Speed w/ Balanced Propagation Delay
- Inputs and Outputs have OVT Protection to 4.5 V
- Non-preferential V_{CCA} and V_{CCB} Sequencing
- Outputs at 3-State until Active V_{CC} is Reached
- Power-Off Protection
- Outputs Switch to 3-State with V_{CCB} at GND
- Ultra-Small Packaging: 1.2 mm x 1.0 mm UDFN6
- This is a Pb-Free Device

Typical Applications

- Mobile Phones, PDAs, Other Portable Devices

Important Information

- ESD Protection for All Pins:
Human Body Model (HBM) > 2000 V

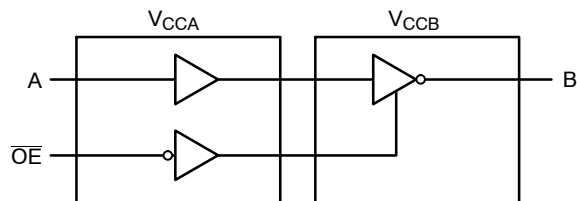
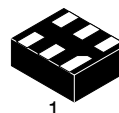

Figure 1. Logic Diagram



ON Semiconductor®

<http://onsemi.com>



UDFN6
MU SUFFIX
CASE 517AA

MARKING DIAGRAM

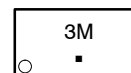

- 3 = Specific Device Code
- M = Date Code
- = Pb-Free Package

PIN ASSIGNMENT

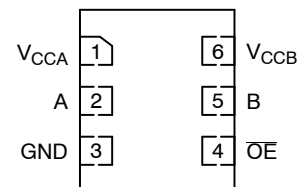

(Top View)

ORDERING INFORMATION

Device	Package	Shipping†
NLSV1T240MUTBG	UDFN6 (Pb-Free)	3000/Tape & Reel

†For information on tape and reel specifications, including part orientation and tape sizes, please refer to our Tape and Reel Packaging Specification Brochure, BRD8011/D.

NLSV1T240

PIN ASSIGNMENT

PIN	FUNCTION
V _{CCA}	Input Port DC Power Supply
V _{CCB}	Output Port DC Power Supply
GND	Ground
A	Input Port
B	Output Port
\overline{OE}	Output Enable

TRUTH TABLE

Inputs		Outputs
\overline{OE}	A	B
L	L	H
L	H	L
H	X	3-State

MAXIMUM RATINGS

Symbol	Rating	Value	Condition	Unit	
V _{CCA} , V _{CCB}	DC Supply Voltage	-0.5 to +5.5		V	
V _I	DC Input Voltage	A	-0.5 to +5.5	V	
V _C	Control Input	\overline{OE}	-0.5 to +5.5	V	
V _O	DC Output Voltage (Power Down)	B	-0.5 to +5.5	V _{CCA} = V _{CCB} = 0	V
	(Active Mode)	B	-0.5 to +5.5		V
	(Tri-State Mode)	B	-0.5 to +5.5		V
I _{IK}	DC Input Diode Current		-20	V _I < GND	mA
I _{OK}	DC Output Diode Current		-50	V _O < GND	mA
I _O	DC Output Source/Sink Current		±50		mA
I _{CCA} , I _{CCB}	DC Supply Current Per Supply Pin		±100		mA
I _{GND}	DC Ground Current per Ground Pin		±100		mA
T _{STG}	Storage Temperature		-65 to +150		°C

Stresses exceeding Maximum Ratings may damage the device. Maximum Ratings are stress ratings only. Functional operation above the Recommended Operating Conditions is not implied. Extended exposure to stresses above the Recommended Operating Conditions may affect device reliability.

RECOMMENDED OPERATING CONDITIONS

Symbol	Parameter	Min	Max	Unit	
V _{CCA} , V _{CCB}	Positive DC Supply Voltage	0.9	4.5	V	
V _I	Bus Input Voltage	GND	4.5	V	
V _C	Control Input	\overline{OE}	GND	4.5	V
V _{IO}	Bus Output Voltage (Power Down Mode)	B	GND	4.5	V
	(Active Mode)	B	GND	V _{CCB}	V
	(Tri-State Mode)	B	GND	4.5	V
T _A	Operating Temperature Range	-40	+85	°C	
Δt / ΔV	Input Transition Rise or Rate V _I , from 30% to 70% of V _{CC} ; V _{CC} = 3.3 V ±0.3 V	0	10	nS	

NLSV1T240

DC ELECTRICAL CHARACTERISTICS

Symbol	Parameter	Test Conditions	V _{CCA} (V)	V _{CCB} (V)	-40°C to +85°C		Unit
					Min	Max	
V _{IH}	Input HIGH Voltage (A, OE)		3.6 – 4.5	0.9 – 4.5	2.2	–	V
			2.7 – 3.6		2.0	–	
			2.3 – 2.7		1.6	–	
			1.4 – 2.3		0.65 * V _{CCA}	–	
			0.9 – 1.4		0.9 * V _{CCA}	–	
V _{IL}	Input LOW Voltage (A, OE)		3.6 – 4.5	0.9 – 4.5	–	0.8	V
			2.7 – 3.6		–	0.8	
			2.3 – 2.7		–	0.7	
			1.4 – 2.3		–	0.35 * V _{CCA}	
			0.9 – 1.4		–	0.1 * V _{CCA}	
V _{OH}	Output HIGH Voltage	I _{OH} = -100 μA; V _I = V _{IL}	0.9 – 4.5	0.9 – 4.5	V _{CCB} - 0.2	–	V
		I _{OH} = -0.5 mA; V _I = V _{IL}	0.9	0.9	0.75 * V _{CCB}	–	
		I _{OH} = -2 mA; V _I = V _{IL}	1.4	1.4	1.05	–	
		I _{OH} = -6 mA; V _I = V _{IL}	1.65	1.65	1.25	–	
			2.3	2.3	2.0	–	
		I _{OH} = -12 mA; V _I = V _{IL}	2.3	2.3	1.8	–	
			2.7	2.7	2.2	–	
		I _{OH} = -18 mA; V _I = V _{IL}	2.3	2.3	1.7	–	
3.0	3.0		2.4	–			
V _{OL}	Output LOW Voltage	I _{OL} = 100 μA; V _I = V _{IH}	0.9 – 4.5	0.9 – 4.5	–	0.2	V
		I _{OL} = 0.5 mA; V _I = V _{IH}	1.1	1.1	–	0.3	
		I _{OL} = 2 mA; V _I = V _{IH}	1.4	1.4	–	0.35	
		I _{OL} = 6 mA; V _I = V _{IH}	1.65	1.65	–	0.3	
			2.3	2.3	–	0.4	
		I _{OL} = 12 mA; V _I = V _{IH}	2.7	2.7	–	0.4	
			2.3	2.3	–	0.6	
		I _{OL} = 24 mA; V _I = V _{IH}	3.0	3.0	–	0.4	
I _I	Input Leakage Current	V _I = V _{CCA} or GND	0.9 – 4.5	0.9 – 4.5	-1.0	1.0	μA
I _{OFF}	Power-Off Leakage Current	OE = 0 V	0 0.9 – 4.5	0.9 – 4.5 0	-1.0 -1.0	1.0 1.0	μA
I _{CCA}	Quiescent Supply Current	V _I = V _{CCA} or GND; I _O = 0, V _{CCA} = V _{CCB}	0.9 – 4.5	0.9 – 4.5	–	1.0	μA
I _{CCB}	Quiescent Supply Current	V _I = V _{CCA} or GND; I _O = 0, V _{CCA} = V _{CCB}	0.9 – 4.5	0.9 – 4.5	–	1.0	μA
I _{CCA} + I _{CCB}	Quiescent Supply Current	V _I = V _{CCA} or GND; I _O = 0, V _{CCA} = V _{CCB}	0.9 – 4.5	0.9 – 4.5	–	2.0	μA
ΔI _{CCA}	Increase in I _{CC} per Input Voltage, Other Inputs at V _{CCA} or GND	V _I = V _{CCA} - 0.6 V; V _I = V _{CCA} or GND	4.5	4.5	–	10	μA
			3.6	3.6	–	5.0	
ΔI _{CCB}	Increase in I _{CC} per Input Voltage, Other Inputs at V _{CCA} or GND	V _I = V _{CCA} - 0.6 V; V _I = V _{CCA} or GND	4.5	4.5	–	10	μA
			3.6	3.6	–	5.0	
I _{OZ}	I/O Tri-State Output Leakage Current	T _A = 25°C, OE = 0 V	0.9 – 4.5	0.9 – 4.5	-1.0	1.0	μA

NLSV1T240

TOTAL STATIC POWER CONSUMPTION ($I_{CCA} + I_{CCB}$)

V_{CCA} (V)	-40°C to +85°C										Unit
	V_{CCB} (V)										
	4.5		3.3		2.8		1.8		0.9		
	Min	Max	Min	Max	Min	Max	Min	Max	Min	Max	
4.5		2		2		2		2		< 1.5	μ A
3.3		2		2		2		2		< 1.5	μ A
2.8		< 2		< 1		< 1		< 0.5		< 0.5	μ A
1.8		< 1		< 1		< 0.5		< 0.5		< 0.5	μ A
0.9		< 0.5		< 0.5		< 0.5		< 0.5		< 0.5	μ A

NOTE: Connect ground before applying supply voltage V_{CCA} or V_{CCB} . This device is designed with the feature that the power-up sequence of V_{CCA} and V_{CCB} will not damage the IC.

AC ELECTRICAL CHARACTERISTICS

Symbol	Parameter	V_{CCA} (V)	-40°C to +85°C										Unit
			V_{CCB} (V)										
			4.5		3.3		2.8		1.8		1.2		
			Min	Max	Min	Max	Min	Max	Min	Max	Min	Max	
t_{PLH} , t_{PHL} (Note 1)	Propagation Delay, A to B	4.5		1.6		1.8		2.0		2.1		2.3	nS
		3.3		1.7		1.9		2.1		2.3		2.6	
		2.8		1.9		2.1		2.3		2.5		2.8	
		1.8		2.1		2.4		2.5		2.7		3.0	
		1.2		2.4		2.7		2.8		3.0		3.3	
t_{PZH} , t_{PZL} (Note 1)	Output Enable, \overline{OE} to B	4.5		2.6		3.8		4.0		4.1		4.3	nS
		3.3		3.7		3.9		4.1		4.3		4.6	
		2.5		3.9		4.1		4.3		4.5		4.8	
		1.8		4.1		4.4		4.5		4.7		5.0	
		1.2		4.4		4.7		4.8		5.0		5.3	
t_{PHZ} , t_{PLZ} (Note 1)	Output Disable, \overline{OE} to B	4.5		2.6		3.8		4.0		4.1		4.3	nS
		3.3		3.7		3.9		4.1		4.3		4.6	
		2.5		3.9		4.1		4.3		4.5		4.8	
		1.8		4.1		4.4		4.5		4.7		5.0	
		1.2		4.4		4.7		4.8		5.0		5.3	
t_{OSHL} , t_{OSLH} (Note 1)	Output to Output Skew, Time	4.5		0.15		0.15		0.15		0.15		0.15	nS
		3.3		0.15		0.15		0.15		0.15		0.15	
		2.5		0.15		0.15		0.15		0.15		0.15	
		1.8		0.15		0.15		0.15		0.15		0.15	
		1.2		0.15		0.15		0.15		0.15		0.15	

1. Propagation delays defined per Figure 2.

CAPACITANCE

Symbol	Parameter	Test Conditions	Typ (Note 2)	Unit
C_{IN}	Control Pin Input Capacitance	$V_{CCA} = V_{CCB} = 3.3$ V, $V_I = 0$ V or $V_{CCA/B}$	3.5	pF
$C_{I/O}$	I/O Pin Input Capacitance	$V_{CCA} = V_{CCB} = 3.3$ V, $V_I = 0$ V or $V_{CCA/B}$	5.0	pF
C_{PD}	Power Dissipation Capacitance	$V_{CCA} = V_{CCB} = 3.3$ V, $V_I = 0$ V or V_{CCA} , $f = 10$ MHz	5.0	pF

2. Typical values are at $T_A = +25^\circ\text{C}$.

3. C_{PD} is defined as the value of the IC's equivalent capacitance from which the operating current can be calculated from:
 $I_{CC(\text{operating})} \cong C_{PD} \times V_{CC} \times f_{IN}$ where $I_{CC} = I_{CCA} + I_{CCB}$.

NLSV1T240



Figure 2. AC (Propagation Delay) Test Circuit

Test	Switch
t_{PLH} , t_{PHL}	OPEN
t_{PLZ} , t_{PZL}	$V_{CC} \times 2$
t_{PHZ} , t_{PZH}	GND

$C_L = 15 \text{ pF}$ or equivalent (includes probe and jig capacitance)
 $R_L = 2 \text{ k}\Omega$ or equivalent
 Z_{OUT} of pulse generator = 50Ω

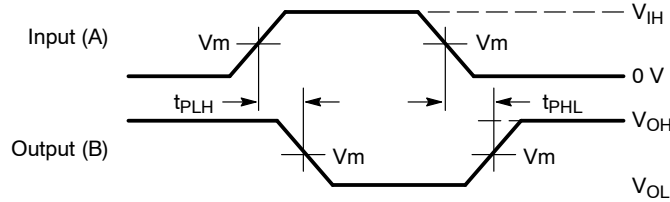

Waveform 1 - Propagation Delays

$t_R = t_F = 2.0 \text{ ns}$, 10% to 90%; $f = 1 \text{ MHz}$; $t_W = 500 \text{ ns}$

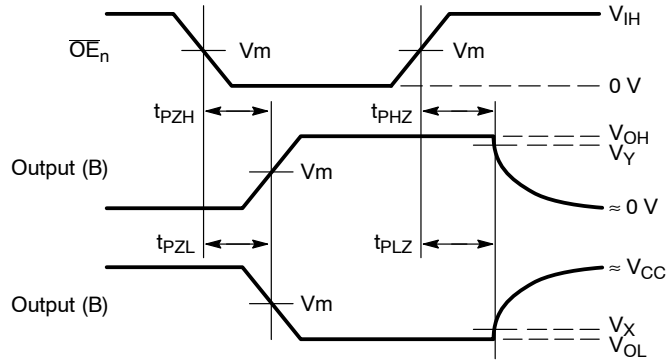

Waveform 2 - Output Enable and Disable Times

$t_R = t_F = 2.0 \text{ ns}$, 10% to 90%; $f = 1 \text{ MHz}$; $t_W = 500 \text{ ns}$

Figure 3. AC (Propagation Delay) Test Circuit Waveforms

Symbol	V_{CC}				
	3.0 V - 4.5 V	2.3 V - 2.7 V	1.65 V - 1.95 V	1.4 V - 1.6 V	0.9 V - 1.3 V
V_{mA}	$V_{CCA}/2$	$V_{CCA}/2$	$V_{CCA}/2$	$V_{CCA}/2$	$V_{CCA}/2$
V_{mB}	$V_{CCB}/2$	$V_{CCB}/2$	$V_{CCB}/2$	$V_{CCB}/2$	$V_{CCB}/2$
V_X	$V_{OL} \times 0.1$	$V_{OL} \times 0.1$	$V_{OL} \times 0.1$	$V_{OL} \times 0.1$	$V_{OL} \times 0.1$
V_Y	$V_{OH} \times 0.9$	$V_{OH} \times 0.9$	$V_{OH} \times 0.9$	$V_{OH} \times 0.9$	$V_{OH} \times 0.9$

NLSV1T240

PACKAGE DIMENSIONS

UDFN6 1.2 x 1.0, 0.4P
CASE 517AA
ISSUE C

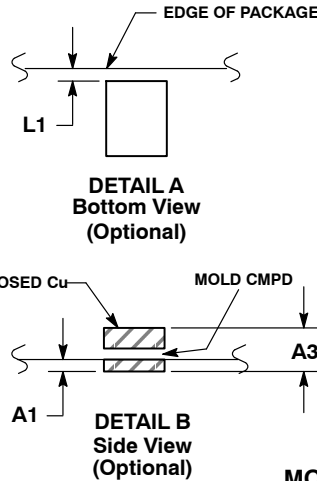
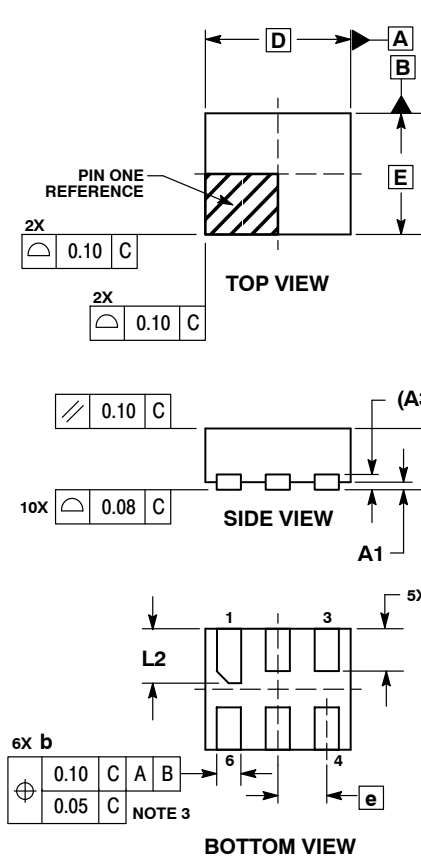

NOTES:

1. DIMENSIONING AND TOLERANCING PER ASME Y14.5M, 1994.
2. CONTROLLING DIMENSION: MILLIMETERS.
3. DIMENSION b APPLIES TO PLATED TERMINAL AND IS MEASURED BETWEEN 0.25 AND 0.30 mm FROM TERMINAL.
4. COPLANARITY APPLIES TO THE EXPOSED PAD AS WELL AS THE TERMINALS.

MILLIMETERS		
DIM	MIN	MAX
A	0.45	0.55
A1	0.00	0.05
A3	0.127 REF	
b	0.15	0.25
D	1.20	BSC
E	1.00	BSC
e	0.40	BSC
L	0.30	0.40
L1	0.00	0.15
L2	0.40	0.50

MOUNTING FOOTPRINT*

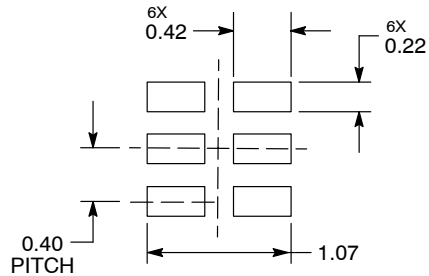

DIMENSIONS: MILLIMETERS

*For additional information on our Pb-Free strategy and soldering details, please download the ON Semiconductor Soldering and Mounting Techniques Reference Manual, SOLDERRM/D.

ON Semiconductor and are registered trademarks of Semiconductor Components Industries, LLC (SCILLC). SCILLC reserves the right to make changes without further notice to any products herein. SCILLC makes no warranty, representation or guarantee regarding the suitability of its products for any particular purpose, nor does SCILLC assume any liability arising out of the application or use of any product or circuit, and specifically disclaims any and all liability, including without limitation special, consequential or incidental damages. "Typical" parameters which may be provided in SCILLC data sheets and/or specifications can and do vary in different applications and actual performance may vary over time. All operating parameters, including "Typicals" must be validated for each customer application by customer's technical experts. SCILLC does not convey any license under its patent rights nor the rights of others. SCILLC products are not designed, intended, or authorized for use as components in systems intended for surgical implant into the body, or other applications intended to support or sustain life, or for any other application in which the failure of the SCILLC product could create a situation where personal injury or death may occur. Should Buyer purchase or use SCILLC products for any such unintended or unauthorized application, Buyer shall indemnify and hold SCILLC and its officers, employees, subsidiaries, affiliates, and distributors harmless against all claims, costs, damages, and expenses, and reasonable attorney fees arising out of, directly or indirectly, any claim of personal injury or death associated with such unintended or unauthorized use, even if such claim alleges that SCILLC was negligent regarding the design or manufacture of the part. SCILLC is an Equal Opportunity/Affirmative Action Employer. This literature is subject to all applicable copyright laws and is not for resale in any manner.

PUBLICATION ORDERING INFORMATION

LITERATURE FULFILLMENT:
Literature Distribution Center for ON Semiconductor
P.O. Box 5163, Denver, Colorado 80217 USA
Phone: 303-675-2175 or 800-344-3860 Toll Free USA/Canada
Fax: 303-675-2176 or 800-344-3867 Toll Free USA/Canada
Email: orderlit@onsemi.com

N. American Technical Support: 800-282-9855 Toll Free USA/Canada
Europe, Middle East and Africa Technical Support:
Phone: 421 33 790 2910
Japan Customer Focus Center
Phone: 81-3-5817-1050

ON Semiconductor Website: www.onsemi.com
Order Literature: <http://www.onsemi.com/orderlit>

For additional information, please contact your local Sales Representative