

Single Inverter

NLV74HC1G04

The NLV74HC1G04 is a high speed CMOS inverter fabricated with silicon gate CMOS technology.

The internal circuit is composed of multiple stages, including a buffer output which provides high noise immunity and stable output.

The NLV74HC1G04 output drive current is 1/2 compared to NLV74HC series.

Features

- High Speed: $t_{PD} = 7 \text{ ns}$ (Typ) at $V_{CC} = 5 \text{ V}$
- Low Power Dissipation: $I_{CC} = 1 \mu\text{A}$ (Max) at $T_A = 25^\circ\text{C}$
- High Noise Immunity
- Balanced Propagation Delays ($t_{pLH} = t_{pHL}$)
- Symmetrical Output Impedance ($I_{OH} = I_{OL} = 2 \text{ mA}$)
- Chip Complexity: < 100 FETs
- NLV Prefix for Automotive and Other Applications Requiring Unique Site and Control Change Requirements; AEC-Q100 Qualified and PPAP Capable
- These Devices are Pb-Free, Halogen Free/BFR Free and are RoHS Compliant

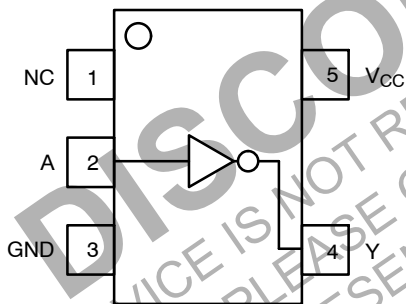

Figure 1. Pinout

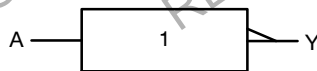
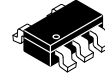

Figure 2. Logic Symbol

| PIN ASSIGNMENT | |
|----------------|-----------------|
| 1 | NC |
| 2 | A |
| 3 | GND |
| 4 | Y |
| 5 | V _{CC} |



SC-88A
DF SUFFIX
CASE 419A



TSOP-5
DT SUFFIX
CASE 483

MARKING DIAGRAMS

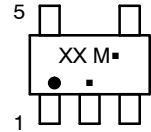
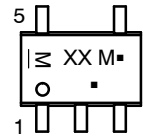

XX = Device Code
M = Date Code*
▪ = Pb-Free Package

(Note: Microdot may be in either location)

*Date Code orientation and/or position may vary depending upon manufacturing location.

FUNCTION TABLE

| Input A | Output Y |
|---------|----------|
| L | H |
| H | L |

ORDERING INFORMATION

See detailed ordering, marking and shipping information in the package dimensions section on page 5 of this data sheet.

NLV74HC1G04

MAXIMUM RATINGS

| Symbol | Parameter | Value | Unit |
|-------------------------------------|---|--|------|
| V _{CC} | DC Supply Voltage | -0.5 to +7.0 | V |
| V _{IN} | DC Input Voltage | -0.5 to V _{CC} +0.5 | V |
| V _{OUT} | DC Output Voltage | -0.5 to V _{CC} +0.5 | V |
| I _{IK} | DC Input Diode Current | ±20 | mA |
| I _{OK} | DC Output Diode Current | ±20 | mA |
| I _{OUT} | DC Output Source/Sink Current | ±12.5 | mA |
| I _{CC} or I _{GND} | DC Supply Current per Supply Pin or Ground Pin | ±25 | mA |
| T _{STG} | Storage Temperature Range | -65 to +150 | °C |
| T _L | Lead Temperature, 1 mm from Case for 10 Seconds | 260 | °C |
| T _J | Junction Temperature Under Bias | +150 | °C |
| θ _{JA} | Thermal Resistance (Note 1) | SC-88A TSOP-5 377 320 | °C/W |
| P _D | Power Dissipation in Still Air at 85°C | SC-88A TSOP-5 332 390 | mW |
| MSL | Moisture Sensitivity | Level 1 | |
| F _R | Flammability Rating | Oxygen Index: 28 to 34 UL 94 V-0 @ 0.125 in | |
| V _{ESD} | ESD Withstand Voltage (Note 2) | Human Body Model Charged Device Model 2000 1000 | V |
| I _{LATCHUP} | Latchup Performance (Note 3) | ±500 | mA |

Stresses exceeding those listed in the Maximum Ratings table may damage the device. If any of these limits are exceeded, device functionality should not be assumed, damage may occur and reliability may be affected.

1. Measured with minimum pad spacing on an FR4 board, using 10 mm-by-1 inch, 20 ounce copper trace with no air flow per JESD51-7.
2. HBM tested to ANSI/ESDA/JEDEC JS-001-2017. CDM tested to JESD22-C101-F. JEDEC recommends that ESD qualification to EIA/JESD22-A115A (Machine Model) be discontinued per JEDEC/JEP172A.
3. Tested to EIA/JESD78 Class II.

RECOMMENDED OPERATING CONDITIONS

| Symbol | Parameter | Min | Max | Unit |
|---------------------------------|-----------------------------|--|--------------------------------|------|
| V _{CC} | DC Supply Voltage | 2.0 | 6.0 | V |
| V _{IN} | DC Input Voltage | 0.0 | V _{CC} | V |
| V _{OUT} | DC Output Voltage | 0.0 | V _{CC} | V |
| T _A | Operating Temperature Range | -55 | +125 | °C |
| t _r , t _f | Input Rise and Fall Time | V _{CC} = 2.0 V V _{CC} = 3.0 V V _{CC} = 4.5 V V _{CC} = 6.0 V | 0 1000 600 500 400 | ns |

Functional operation above the stresses listed in the Recommended Operating Ranges is not implied. Extended exposure to stresses beyond the Recommended Operating Ranges limits may affect device reliability.

NLV74HC1G04

DC ELECTRICAL CHARACTERISTICS

| Symbol | Parameter | Test Conditions | V _{CC} (V) | T _A = 25°C | | | -40°C ≤ T _A ≤ 85°C | | -55°C ≤ T _A ≤ 125°C | | Unit |
|-----------------|---------------------------|--|------------------------|-----------------------|------|------|-------------------------------|------|--------------------------------|------|------|
| | | | | Min | Typ | Max | Min | Max | Min | Max | |
| V _{IH} | High-Level Input Voltage | | 2.0 | 1.5 | - | - | 1.5 | - | 1.5 | - | V |
| | | | 3.0 | 2.1 | - | - | 2.1 | - | 2.1 | - | |
| | | | 4.5 | 3.15 | - | - | 3.15 | - | 3.15 | - | |
| | | | 6.0 | 4.20 | - | - | 4.20 | - | 4.20 | - | |
| V _{IL} | Low-Level Input Voltage | | 2.0 | - | - | 0.5 | - | 0.5 | - | 0.5 | V |
| | | | 3.0 | - | - | 0.9 | - | 0.9 | - | 0.9 | |
| | | | 4.5 | - | - | 1.35 | - | 1.35 | - | 1.35 | |
| | | | 6.0 | - | - | 1.80 | - | 1.80 | - | 1.80 | |
| V _{OH} | High-Level Output Voltage | V _{IN} = V _{IH} or V _{IL} I _{OH} = -20 μA | 2.0 | 1.9 | 2.0 | - | 1.9 | - | 1.9 | - | V |
| | | | 3.0 | 2.9 | 3.0 | - | 2.9 | - | 2.9 | - | |
| | | | 4.5 | 4.4 | 4.5 | - | 4.4 | - | 4.4 | - | |
| | | | 6.0 | 5.9 | 6.0 | - | 5.9 | - | 5.9 | - | |
| | | V _{IN} = V _{IH} or V _{IL} I _{OH} = -2 mA I _{OH} = -2.6 mA | 4.5 | 4.18 | 4.31 | - | 4.13 | - | 4.08 | - | |
| | | | 6.0 | 5.68 | 5.80 | - | 5.63 | - | 5.58 | - | |
| V _{OL} | Low-Level Output Voltage | V _{IN} = V _{IH} or V _{IL} I _{OL} = 20 μA | 2.0 | - | 0.0 | 0.1 | - | 0.1 | - | 0.1 | V |
| | | | 3.0 | - | 0.0 | 0.1 | - | 0.1 | - | 0.1 | |
| | | | 4.5 | - | 0.0 | 0.1 | - | 0.1 | - | 0.1 | |
| | | | 6.0 | - | 0.0 | 0.1 | - | 0.1 | - | 0.1 | |
| | | V _{IN} = V _{IH} or V _{IL} I _{OL} = 2 mA I _{OL} = 2.6 mA | 4.5 | - | 0.17 | 0.26 | - | 0.33 | - | 0.40 | |
| | | | 6.0 | - | 0.18 | 0.26 | - | 0.33 | - | 0.40 | |
| I _{IN} | Input Leakage Current | V _{IN} = 6.0 V or GND | 6.0 | - | - | ±0.1 | - | ±1.0 | - | ±1.0 | μA |
| I _{CC} | Quiescent Supply Current | V _{IN} = V _{CC} or GND | 6.0 | - | - | 1.0 | - | 10 | - | 40 | μA |

Product parametric performance is indicated in the Electrical Characteristics for the listed test conditions, unless otherwise noted. Product performance may not be indicated by the Electrical Characteristics if operated under different conditions.

AC ELECTRICAL CHARACTERISTICS

| Symbol | Parameter | Test Conditions | T _A = 25°C | | | -40°C ≤ T _A ≤ 85°C | | -55°C ≤ T _A ≤ 125°C | | Unit |
|--|------------------------------|--|-----------------------|-----|-----|-------------------------------|-----|--------------------------------|-----|------|
| | | | Min | Typ | Max | Min | Max | Min | Max | |
| t _{PLH} , t _{PHL} | Propagation Delay, A to Y | V _{CC} = 5.0 V C _L = 15 pF | - | 3.5 | 15 | - | 20 | - | 25 | ns |
| | | V _{CC} = 2.0 V C _L = 50 pF | - | 20 | 100 | - | 125 | - | 155 | |
| | | V _{CC} = 3.0 V | - | 11 | 27 | - | 35 | - | 90 | |
| | | V _{CC} = 4.5 V | - | 8 | 20 | - | 25 | - | 35 | |
| | | V _{CC} = 6.0 V | - | 7 | 17 | - | 21 | - | 26 | |
| t _{TLH} , t _{THL} | Output Transition Time | V _{CC} = 5.0 V C _L = 15 pF | - | 3 | 10 | - | 15 | - | 20 | ns |
| | | V _{CC} = 2.0 V C _L = 50 pF | - | 25 | 125 | - | 155 | - | 200 | |
| | | V _{CC} = 3.0 V | - | 16 | 35 | - | 45 | - | 60 | |
| | | V _{CC} = 4.5 V | - | 11 | 25 | - | 31 | - | 38 | |
| | | V _{CC} = 6.0 V | - | 9 | 21 | - | 26 | - | 32 | |
| C _{IN} | Input Capacitance | | - | 5 | 10 | - | 10 | - | 10 | pF |

| C _{PD} | Power Dissipation Capacitance (Note 4) | Typical @ 25°C, V _{CC} = 5.0 V | |
|-----------------|--|---|-----|
| | | Min | Max |
| | | 10 | |

4. C_{PD} is defined as the value of the internal equivalent capacitance which is calculated from the operating current consumption without load. Average operating current can be obtained by the equation: I_{CC(OPR)} = C_{PD} • V_{CC} • f_{in} + I_{CC}. C_{PD} is used to determine the no-load dynamic power consumption; P_D = C_{PD} • V_{CC}² • f_{in} + I_{CC} • V_{CC}.

NLV74HC1G04

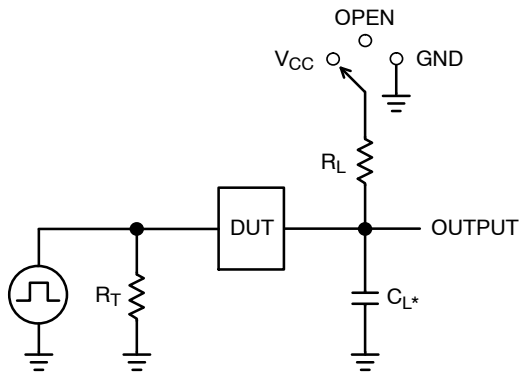

*C_L includes probe and jig capacitance
 R_T is Z_{OUT} of pulse generator (typically 50 Ω)
 f = 1 MHz

Figure 3. Test Circuit

| Test | Switch Position | C _L , pF | R _L , Ω |
|--|-----------------|------------------------------|--------------------|
| t _{PLH} / t _{PHL} | Open | See AC Characteristics Table | X |
| t _{TLH} / t _{THL} (Note 5) | Open | | X |
| t _{PLZ} / t _{PZL} | V _{CC} | 1 k | |
| t _{PHZ} / t _{PZH} | GND | 1 k | |

X - Don't Care

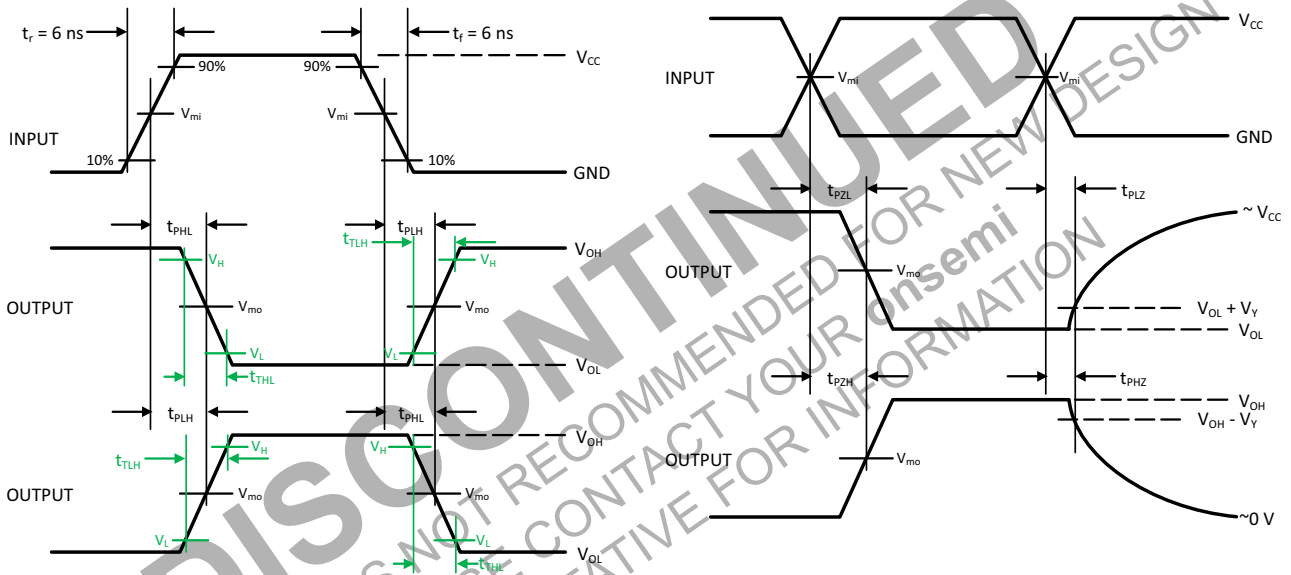

Figure 4. Switching Waveforms

| V _{CC} , V | V _{m1} , V | V _{m0} , V | | V _L , V | V _H , V | V _Y , V |
|---------------------|---------------------|-------------------------------------|---|--|--|--------------------|
| | | t _{PLH} , t _{PHL} | t _{PZL} , t _{PLZ} , t _{PZH} , t _{PHZ} | | | |
| 3.0 to 3.6 | V _{CC} /2 | V _{CC} /2 | V _{CC} /2 | V _{OL} + 0.1 (V _{OH} - V _{OL}) | V _{OL} + 0.9 (V _{OH} - V _{OL}) | 0.3 |
| 4.5 to 5.5 | V _{CC} /2 | V _{CC} /2 | V _{CC} /2 | V _{OL} + 0.1 (V _{OH} - V _{OL}) | V _{OL} + 0.9 (V _{OH} - V _{OL}) | 0.3 |

5. t_{TLH} and t_{THL} are measured from 10% to 90% of (V_{OH} - V_{OL}), and 90% to 10% of (V_{OH} - V_{OL}), respectively.

NLV74HC1G04

ORDERING INFORMATION

| Device | Packages | Specific Device Code | Pin 1 Orientation (See below) | Shipping† |
|------------------------|----------|----------------------|----------------------------------|--------------------|
| MC74HC1G04DFT1G-L22038 | SC-88A | H5 | Q2 | 3000 / Tape & Reel |
| NLVHC1G04DFT1G* | SC-88A | H5 | Q2 | 3000 / Tape & Reel |
| MC74HC1G04DFT2G-L22038 | SC-88A | H5 | Q4 | 3000 / Tape & Reel |
| NLVHC1G04DFT2G* | SC-88A | H5 | Q4 | 3000 / Tape & Reel |
| MC74HC1G04DTT1G | TSOP-5 | H5 | Q4 | 3000 / Tape & Reel |

†For complete information on tape and reel specifications, including part orientation and tape sizes, please refer to our Tape and Reel Packaging Specifications Brochure, BRD8011/D.

*NLV Prefix for Automotive and Other Applications Requiring Unique Site and Control Change Requirements; AEC-Q100 Qualified and PPAP Capable.

Pin 1 Orientation in Tape and Reel

Direction of Feed

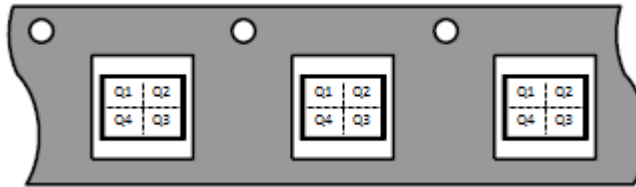

DISCONTINUED
THIS DEVICE IS NOT RECOMMENDED FOR NEW DESIGN
PLEASE CONTACT YOUR ONSEMI REPRESENTATIVE FOR INFORMATION

MECHANICAL CASE OUTLINE PACKAGE DIMENSIONS



SCALE 2:1

SC-88A (SC-70-5/SOT-353) CASE 419A-02 ISSUE M

DATE 11 APR 2023

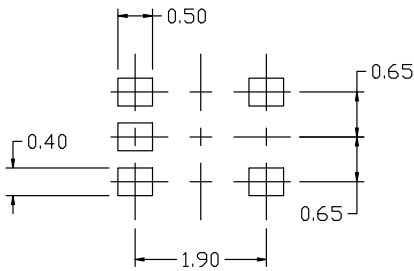
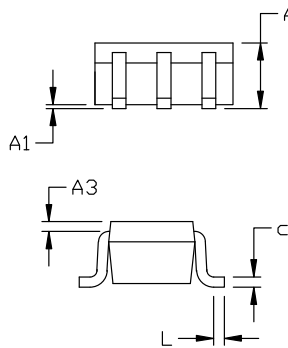
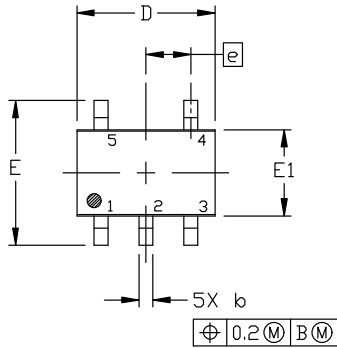

RECOMMENDED MOUNTING FOOTPRINT

* For additional information on our Pb-Free strategy and soldering details, please download the ON Semiconductor Soldering and Mounting Techniques Reference Manual, SOLDERM/D.

NOTES:

1. DIMENSIONING AND TOLERANCING PER ANSI Y14.5M, 1982.
2. CONTROLLING DIMENSION: MILLIMETERS
3. 419A-01 OBSOLETE. NEW STANDARD 419A-02
4. DIMENSIONS D AND E1 DO NOT INCLUDE MOLD FLASH, PROTRUSIONS, OR GATE BURRS. MOLD FLASH, PROTRUSIONS, OR GATE BURRS SHALL NOT EXCEED 0.1016MM PER SIDE.

| DIM | MILLIMETERS | | |
|-----|-------------|------|------|
| | MIN. | NOM. | MAX. |
| A | 0.80 | 0.95 | 1.10 |
| A1 | --- | --- | 0.10 |
| A3 | 0.20 REF | | |
| b | 0.10 | 0.20 | 0.30 |
| c | 0.10 | --- | 0.25 |
| D | 1.80 | 2.00 | 2.20 |
| E | 2.00 | 2.10 | 2.20 |
| E1 | 1.15 | 1.25 | 1.35 |
| e | 0.65 BSC | | |
| L | 0.10 | 0.15 | 0.30 |

GENERIC MARKING DIAGRAM*

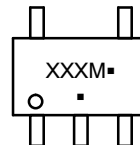

*This information is generic. Please refer to device data sheet for actual part marking. Pb-Free indicator, "G" or microdot "▪", may or may not be present. Some products may not follow the Generic Marking.

XXX = Specific Device Code

M = Date Code

▪ = Pb-Free Package

(Note: Microdot may be in either location)

STYLE 1:

- PIN 1. BASE
- EMITTER
- BASE
- COLLECTOR
- COLLECTOR

STYLE 2:

- PIN 1. ANODE
- EMITTER
- BASE
- COLLECTOR
- CATHODE

STYLE 3:

- PIN 1. ANODE 1
- N/C
- ANODE 2
- CATHODE 2
- CATHODE 1

STYLE 4:

- PIN 1. SOURCE 1
- DRAIN 1/2
- SOURCE 1
- GATE 1
- GATE 2

STYLE 5:

- PIN 1. CATHODE
- COMMON ANODE
- CATHODE 2
- CATHODE 3
- CATHODE 4

STYLE 6:

- PIN 1. EMITTER 2
- BASE 2
- EMITTER 1
- COLLECTOR
- COLLECTOR 2/BASE 1

STYLE 7:

- PIN 1. BASE
- EMITTER
- BASE
- COLLECTOR
- COLLECTOR

STYLE 8:

- PIN 1. CATHODE
- COLLECTOR
- N/C
- BASE
- EMITTER

STYLE 9:

- PIN 1. ANODE
- CATHODE
- ANODE
- ANODE
- ANODE

Note: Please refer to datasheet for style callout. If style type is not called out in the datasheet refer to the device datasheet pinout or pin assignment.

| | | |
|-------------------------|---------------------------------|---|
| DOCUMENT NUMBER: | 98ASB42984B | Electronic versions are uncontrolled except when accessed directly from the Document Repository. Printed versions are uncontrolled except when stamped "CONTROLLED COPY" in red. |
| DESCRIPTION: | SC-88A (SC-70-5/SOT-353) | PAGE 1 OF 1 |

onsemi and ONSEMI are trademarks of Semiconductor Components Industries, LLC dba onsemi or its subsidiaries in the United States and/or other countries. onsemi reserves the right to make changes without further notice to any products herein. onsemi makes no warranty, representation or guarantee regarding the suitability of its products for any particular purpose, nor does onsemi assume any liability arising out of the application or use of any product or circuit, and specifically disclaims any and all liability, including without limitation special, consequential or incidental damages. onsemi does not convey any license under its patent rights nor the rights of others.

MECHANICAL CASE OUTLINE PACKAGE DIMENSIONS

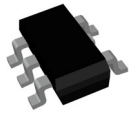

TSOP-5 3.00x1.50x0.95, 0.95P CASE 483 ISSUE P

DATE 01 APR 2024

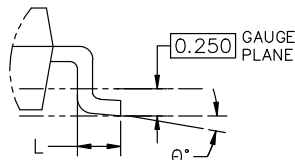
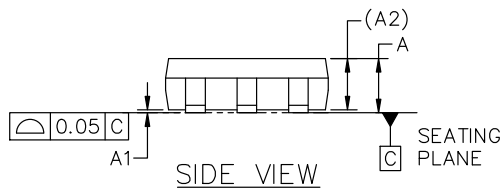
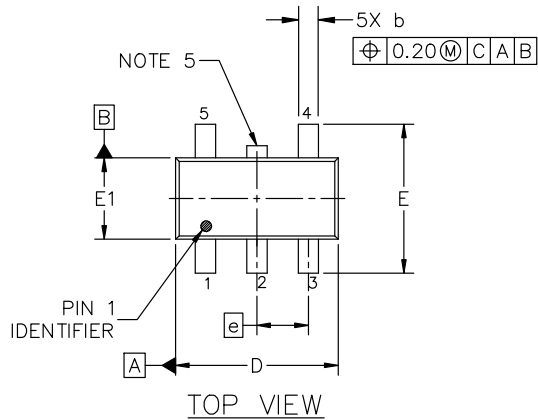

NOTES:

1. DIMENSIONING AND TOLERANCING CONFORM TO ASME Y14.5-2018.
2. ALL DIMENSION ARE IN MILLIMETERS (ANGLES IN DEGREES).
3. MAXIMUM LEAD THICKNESS INCLUDES LEAD FINISH THICKNESS. MINIMUM LEAD THICKNESS IS THE MINIMUM THICKNESS OF BASE MATERIAL.
4. DIMENSIONS D AND E1 DO NOT INCLUDE MOLD FLASH, PROTRUSIONS OF GATE BURRS. MOLD FLASH, PROTRUSIONS, OR GATE BURRS SHALL NOT EXCEED 0.15 PER SIDE. DIMENSION D.
5. OPTIONAL CONSTRUCTION: AN ADDITIONAL TRIMMED LEAD IS ALLOWED IN THIS LOCATION. TRIMMED LEAD NOT TO EXTEND MORE THAN 0.2 FROM BODY.

| DIM | MILLIMETERS | | |
|----------|-------------|-------|-------|
| | MIN. | NOM. | MAX. |
| A | 0.900 | 1.000 | 1.100 |
| A1 | 0.010 | 0.055 | 0.100 |
| A2 | 0.950 REF. | | |
| b | 0.250 | 0.375 | 0.500 |
| c | 0.100 | 0.180 | 0.260 |
| D | 2.850 | 3.000 | 3.150 |
| E | 2.500 | 2.750 | 3.000 |
| E1 | 1.350 | 1.500 | 1.650 |
| e | 0.950 BSC | | |
| L | 0.200 | 0.400 | 0.600 |
| θ | 0° | 5° | 10° |

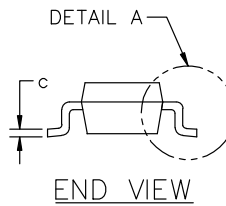

GENERIC MARKING DIAGRAM*

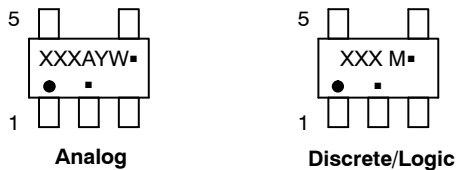

- XXX = Specific Device Code XXX = Specific Device Code
 A = Assembly Location M = Date Code
 Y = Year ▪ = Pb-Free Package
 W = Work Week
- = Pb-Free Package

(Note: Microdot may be in either location)

*This information is generic. Please refer to device data sheet for actual part marking. Pb-Free indicator, "G" or microdot "▪", may or may not be present. Some products may not follow the Generic Marking.

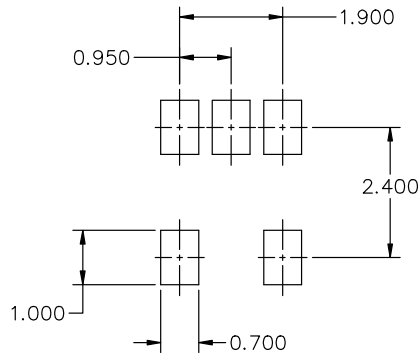

* FOR ADDITIONAL INFORMATION ON OUR Pb-FREE STRATEGY AND SOLDERING DETAILS, PLEASE DOWNLOAD THE ON SEMICONDUCTOR SOLDERING AND MOUNTING TECHNIQUES REFERENCE MANUAL, SOLDERM/D.

| | | |
|------------------|------------------------------|--|
| DOCUMENT NUMBER: | 98ARB18753C | Electronic versions are uncontrolled except when accessed directly from the Document Repository. Printed versions are uncontrolled except when stamped "CONTROLLED COPY" in red. |
| DESCRIPTION: | TSOP-5 3.00x1.50x0.95, 0.95P | PAGE 1 OF 1 |

onsemi and ONSEMI are trademarks of Semiconductor Components Industries, LLC dba onsemi or its subsidiaries in the United States and/or other countries. onsemi reserves the right to make changes without further notice to any products herein. onsemi makes no warranty, representation or guarantee regarding the suitability of its products for any particular purpose, nor does onsemi assume any liability arising out of the application or use of any product or circuit, and specifically disclaims any and all liability, including without limitation special, consequential or incidental damages. onsemi does not convey any license under its patent rights nor the rights of others.

onsemi, **Onsemi**, and other names, marks, and brands are registered and/or common law trademarks of Semiconductor Components Industries, LLC dba "**onsemi**" or its affiliates and/or subsidiaries in the United States and/or other countries. **onsemi** owns the rights to a number of patents, trademarks, copyrights, trade secrets, and other intellectual property. A listing of **onsemi**'s product/patent coverage may be accessed at www.onsemi.com/site/pdf/Patent-Marking.pdf. **onsemi** reserves the right to make changes at any time to any products or information herein, without notice. The information herein is provided "as-is" and **onsemi** makes no warranty, representation or guarantee regarding the accuracy of the information, product features, availability, functionality, or suitability of its products for any particular purpose, nor does **onsemi** assume any liability arising out of the application or use of any product or circuit, and specifically disclaims any and all liability, including without limitation special, consequential or incidental damages. Buyer is responsible for its products and applications using **onsemi** products, including compliance with all laws, regulations and safety requirements or standards, regardless of any support or applications information provided by **onsemi**. "Typical" parameters which may be provided in **onsemi** data sheets and/or specifications can and do vary in different applications and actual performance may vary over time. All operating parameters, including "Typicals" must be validated for each customer application by customer's technical experts. **onsemi** does not convey any license under any of its intellectual property rights nor the rights of others. **onsemi** products are not designed, intended, or authorized for use as a critical component in life support systems or any FDA Class 3 medical devices or medical devices with a same or similar classification in a foreign jurisdiction or any devices intended for implantation in the human body. Should Buyer purchase or use **onsemi** products for any such unintended or unauthorized application, Buyer shall indemnify and hold **onsemi** and its officers, employees, subsidiaries, affiliates, and distributors harmless against all claims, costs, damages, and expenses, and reasonable attorney fees arising out of, directly or indirectly, any claim of personal injury or death associated with such unintended or unauthorized use, even if such claim alleges that **onsemi** was negligent regarding the design or manufacture of the part. **onsemi** is an Equal Opportunity/Affirmative Action Employer. This literature is subject to all applicable copyright laws and is not for resale in any manner.

ADDITIONAL INFORMATION

TECHNICAL PUBLICATIONS:

Technical Library: www.onsemi.com/design/resources/technical-documentation
onsemi Website: www.onsemi.com

ONLINE SUPPORT: www.onsemi.com/support

For additional information, please contact your local Sales Representative at www.onsemi.com/support/sales