

# 2-Input NAND Schmitt-Trigger

## NLV74VHC1G132, NLV74VHC1GT132

The NLV74VHC1G132 / NLV74VHC1GT132 is a single 2-input NAND Schmitt Trigger in tiny footprint packages. The NLV74VHC1G132 has CMOS-level input thresholds while the NLV74VHC1GT132 has TTL-level input thresholds.

The input structures provide protection when voltages up to 5.5 V are applied, regardless of the supply voltage. This allows the device to be used to interface 5 V circuits to 3 V circuits. Some output structures also provide protection when  $V_{CC} = 0$  V and when the output voltage exceeds  $V_{CC}$ . These input and output structures help prevent device destruction caused by supply voltage – input/output voltage mismatch, battery backup, hot insertion, etc.

### Features

- Designed for 2.0 V to 5.5 V  $V_{CC}$  Operation
- 3.6 ns  $t_{PD}$  at 5 V (typ)
- Inputs/Outputs Over-Voltage Tolerant up to 5.5 V
- $I_{OFF}$  Supports Partial Power Down Protection
- Source/Sink 8 mA at 3.0 V
- Available in SC-88A and TSOP-5 Packages
- Chip Complexity < 100 FETs
- NLV Prefix for Automotive and Other Applications Requiring Unique Site and Control Change Requirements; AEC-Q100 Qualified and PPAP Capable
- These Devices are Pb-Free, Halogen Free/BFR Free and are RoHS Compliant

### MARKING DIAGRAMS

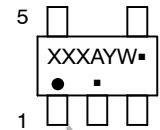
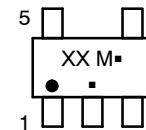
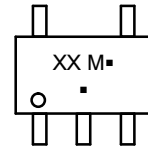

- XX = Specific Device Code
- M = Date Code\*
- = Pb-Free Package

(Note: Microdot may be in either location)

\*Date Code orientation and/or position may vary depending upon manufacturing location.

### ORDERING INFORMATION

See detailed ordering, marking and shipping information on page 7 of this data sheet.



Figure 1. Logic Symbol

NLV74VHC1G132, NLV74VHC1GT132

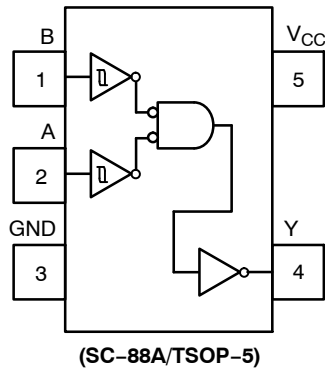

Figure 2. Pinout (Top View)

**PIN ASSIGNMENT**  
(SC-88A/TSOP-5)

Pin	Function
1	B
2	A
3	GND
4	Y
5	V <sub>CC</sub>

**FUNCTION TABLE**

Input		Output
A	B	Y
L	L	H
L	H	H
H	L	H
H	H	L

**DISCONTINUED**  
THIS DEVICE IS NOT RECOMMENDED FOR NEW DESIGN  
PLEASE CONTACT YOUR onsemi  
REPRESENTATIVE FOR INFORMATION

# NLV74VHC1G132, NLV74VHC1GT132

## MAXIMUM RATINGS

Symbol	Characteristics		Value	Unit
V <sub>CC</sub>	DC Supply Voltage		-0.5 to +7.0	V
V <sub>IN</sub>	DC Input Voltage		-0.5 to +7.0	V
V <sub>OUT</sub>	DC Output Voltage	1Gxx	-0.5 to V <sub>CC</sub> + 0.5	V
		1GTxx	Active-Mode (High or Low State) Tri-State Mode (Note 1) Power-Down Mode (V <sub>CC</sub> = 0 V)	
I <sub>IK</sub>	DC Input Diode Current V <sub>IN</sub> < GND		-20	mA
I <sub>OK</sub>	DC Output Diode Current	1Gxx	V <sub>OUT</sub> > V <sub>CC</sub> ; V <sub>OUT</sub> < GND	mA
		1GTxx	V <sub>OUT</sub> < GND	
I <sub>OUT</sub>	DC Output Source/Sink Current		±25	mA
I <sub>CC</sub> or I <sub>GND</sub>	DC Supply Current per Supply Pin or Ground Pin		±50	mA
T <sub>STG</sub>	Storage Temperature Range		-65 to +150	°C
T <sub>L</sub>	Lead Temperature, 1 mm from Case for 10 secs		260	°C
T <sub>J</sub>	Junction Temperature Under Bias		+150	°C
θ <sub>JA</sub>	Thermal Resistance (Note 2)	SC-88A	377	°C/W
		TSOP-5	320	
P <sub>D</sub>	Power Dissipation in Still Air	SC-88A	332	mW
		TSOP-5	390	
MSL	Moisture Sensitivity		Level 1	-
F <sub>R</sub>	Flammability Rating Oxygen Index: 28 to 34		UL 94 V-0 @ 0.125 in	-
V <sub>ESD</sub>	ESD Withstand Voltage (Note 3)	Human Body Model	2000	V
		Charged Device Model	1000	
I <sub>Latchup</sub>	Latchup Performance (Note 4)		±100	mA

Stresses exceeding those listed in the Maximum Ratings table may damage the device. If any of these limits are exceeded, device functionality should not be assumed, damage may occur and reliability may be affected.

1. Applicable to devices with outputs that may be tri-stated.
2. Measured with minimum pad spacing on an FR4 board, using 10mm-by-1inch, 2 ounce copper trace no air flow per JESD51-7.
3. HBM tested to ANSI/ESDA/JEDEC JS-001-2017. CDM tested to EIA/JESD22-C101-F. JEDEC recommends that ESD qualification to EIA/JESD22-A115-A (Machine Model) be discontinued per JEDEC/JEP172A.
4. Tested to EIA/JESD78 Class II.

# NLV74VHC1G132, NLV74VHC1GT132

## RECOMMENDED OPERATING CONDITIONS

Symbol	Characteristics		Min	Max	Unit	
V <sub>CC</sub>	Positive DC Supply Voltage		2.0	5.5	V	
V <sub>IN</sub>	DC Input Voltage		0	5.5	V	
V <sub>OUT</sub>	DC Output Voltage	1Gxx	0	V <sub>CC</sub>	V	
		1GTxx	Active-Mode (High or Low State)	0		V <sub>CC</sub>
			Tri-State Mode	0		5.5
		Power-Down Mode (V <sub>CC</sub> = 0 V)	0	5.5		
T <sub>A</sub>	Operating Temperature Range		-55	+125	°C	
t <sub>r</sub> , t <sub>f</sub>	Input Rise and Fall Time				ns/V	
		V <sub>CC</sub> = 3.0 V to 3.6 V	0	No Limit		
		V <sub>CC</sub> = 4.5 V to 5.5 V	0	No Limit		

Functional operation above the stresses listed in the Recommended Operating Ranges is not implied. Extended exposure to stresses beyond the Recommended Operating Ranges limits may affect device reliability.

## DC ELECTRICAL CHARACTERISTICS (NLV74VHC1G132)

Symbol	Parameter	Test Conditions	V <sub>CC</sub> (V)	T <sub>A</sub> = 25°C			-40°C ≤ T <sub>A</sub> ≤ 85°C		-55°C ≤ T <sub>A</sub> ≤ 125°C		Unit
				Min	Typ	Max	Min	Max	Min	Max	
V <sub>T+</sub>	Positive Input Threshold Voltage		3.0	1.2	2.0	2.2	-	2.2	-	2.2	V
			4.5	1.75	3.0	3.15	-	3.15	-	3.15	
			5.5	2.15	3.6	3.85	-	3.85	-	3.85	
V <sub>T-</sub>	Negative Input Threshold Voltage		3.0	0.9	1.5	1.9	0.9	-	0.9	-	V
			4.5	1.35	2.3	2.75	1.35	-	1.35	-	
			5.5	1.65	2.9	3.35	1.65	-	1.65	-	
V <sub>H</sub>	Hysteresis Voltage		3.0	0.30	0.57	1.20	0.30	1.20	0.30	1.20	V
			4.5	0.40	0.67	1.40	0.40	1.40	0.40	1.40	
			5.5	0.50	0.74	1.60	0.50	1.60	0.50	1.60	
V <sub>OH</sub>	High-Level Output Voltage	V <sub>IN</sub> = V <sub>IH</sub> or V <sub>IL</sub> I <sub>OH</sub> = -50 μA	2.0	1.9	2.0	-	1.9	-	1.9	-	V
			3.0	2.9	3.0	-	2.9	-	2.9	-	
			4.5	4.4	4.5	-	4.4	-	4.4	-	
			3.0	2.58	-	-	2.48	-	2.34	-	
			4.5	3.94	-	-	3.80	-	3.66	-	
V <sub>OL</sub>	Low-Level Output Voltage	V <sub>IN</sub> = V <sub>IH</sub> or V <sub>IL</sub> I <sub>OL</sub> = 50 μA	2.0	-	0.0	0.1	-	0.1	-	0.1	V
			3.0	-	0.0	0.1	-	0.1	-	0.1	
			4.5	-	0.0	0.1	-	0.1	-	0.1	
			3.0	-	-	0.36	-	0.44	-	0.52	
			4.5	-	-	0.36	-	0.44	-	0.52	
I <sub>IN</sub>	Input Leakage Current	V <sub>IN</sub> = 5.5 V or GND	2.0 to 5.5	-	-	±0.1	-	±1.0	-	±1.0	μA
I <sub>OFF</sub>	Power Off Leakage Current	V <sub>IN</sub> = 5.5 V	0.0	-	-	1.0	-	10	-	10	μA
I <sub>CC</sub>	Quiescent Supply Current	V <sub>IN</sub> = V <sub>CC</sub> or GND	5.5	-	-	1.0	-	20	-	40	μA

# NLV74VHC1G132, NLV74VHC1GT132

## DC ELECTRICAL CHARACTERISTICS (NLV74VHC1GT132)

Symbol	Parameter	Test Conditions	V <sub>CC</sub> (V)	T <sub>A</sub> = 25°C			-40°C ≤ T <sub>A</sub> ≤ 85°C		-55°C ≤ T <sub>A</sub> ≤ 125°C		Unit
				Min	Typ	Max	Min	Max	Min	Max	
V <sub>T+</sub>	Positive Input Threshold Voltage		3.0	1.2	1.4	1.6	-	1.6	-	1.6	V
			4.5	1.58	1.74	2.0	-	2.0	-	2.0	
			5.5	1.79	1.94	2.1	-	2.1	-	2.1	
V <sub>T-</sub>	Negative Input Threshold Voltage		3.0	0.35	0.76	0.93	0.35	-	0.35	-	V
			4.5	0.5	1.01	1.18	0.5	-	0.5	-	
			5.5	0.6	1.13	1.29	0.6	-	0.6	-	
V <sub>H</sub>	Hysteresis Voltage		3.0	0.30	0.64	1.20	0.30	1.20	0.30	1.20	V
			4.5	0.40	0.73	1.40	0.40	1.40	0.40	1.40	
			5.5	0.50	0.81	1.60	0.50	1.60	0.50	1.60	
V <sub>OH</sub>	High-Level Output Voltage	V <sub>IN</sub> = V <sub>IH</sub> or V <sub>IL</sub>	2.0	1.9	2.0	-	1.9	-	1.9	-	V
		I <sub>OH</sub> = -50 μA	3.0	2.9	3.0	-	2.9	-	2.9	-	
		I <sub>OH</sub> = -50 μA	4.5	4.4	4.5	-	4.4	-	4.4	-	
		I <sub>OH</sub> = -4 mA	3.0	2.58	-	-	2.48	-	2.34	-	
		I <sub>OH</sub> = -8 mA	4.5	3.94	-	-	3.80	-	3.66	-	
V <sub>OL</sub>	Low-Level Output Voltage	V <sub>IN</sub> = V <sub>IH</sub> or V <sub>IL</sub>	2.0	-	0.0	0.1	-	0.1	-	0.1	V
		I <sub>OL</sub> = 50 μA	3.0	-	0.0	0.1	-	0.1	-	0.1	
		I <sub>OL</sub> = 50 μA	4.5	-	0.0	0.1	-	0.1	-	0.1	
		I <sub>OL</sub> = 4 mA	3.0	-	-	0.36	-	0.44	-	0.52	
		I <sub>OL</sub> = 8 mA	4.5	-	-	0.36	-	0.44	-	0.52	
I <sub>IN</sub>	Input Leakage Current	V <sub>IN</sub> = 5.5 V or GND	2.0 to 5.5	-	-	±0.1	-	±1.0	-	±1.0	μA
I <sub>OFF</sub>	Power Off Leakage Current	V <sub>IN</sub> = 5.5 V or V <sub>OUT</sub> = 5.5 V	0	-	-	1.0	-	10	-	10	μA
I <sub>CC</sub>	Quiescent Supply Current	V <sub>IN</sub> = V <sub>CC</sub> or GND	5.5	-	-	1.0	-	20	-	40	μA
I <sub>CCT</sub>	Increase in Quiescent Supply Current per Input Pin	One Input: V <sub>IN</sub> = 3.4 V; Other Input at V <sub>CC</sub> or GND	5.5	-	-	1.35	-	1.5	-	1.65	mA

## AC ELECTRICAL CHARACTERISTICS

Symbol	Parameter	Conditions	V <sub>CC</sub> (V)	T <sub>A</sub> = 25°C			-40°C ≤ T <sub>A</sub> ≤ 85°C		-55°C ≤ T <sub>A</sub> ≤ 125°C		Unit
				Min	Typ	Max	Min	Max	Min	Max	
t <sub>PLH</sub> , t <sub>PHL</sub>	Propagation Delay, A to Y (Figures 3 and 4)	C <sub>L</sub> = 15 pF	3.0 to 3.6	-	4.6	11.9	-	14.0	-	16.1	ns
				-	6.1	15.4	-	17.5	-	19.6	
		C <sub>L</sub> = 50 pF	4.5 to 5.5	-	3.6	7.7	-	9.0	-	10.3	
				-	4.3	9.7	-	11.0	-	12.3	
C <sub>IN</sub>	Input Capacitance			-	4.0	10	-	10	-	10	pF
C <sub>OUT</sub>	Output Capacitance	Output in High Impedance State		-	6.0	-	-	-	-	-	pF

C <sub>PD</sub>	Power Dissipation Capacitance (Note 5)	Typical @ 25°C, V <sub>CC</sub> = 5.0 V	
		Value	Unit
		8.0	pF

5. C<sub>PD</sub> is defined as the value of the internal equivalent capacitance which is calculated from the operating current consumption without load. Average operating current can be obtained by the equation: I<sub>CC(OPR)</sub> = C<sub>PD</sub> • V<sub>CC</sub> • f<sub>in</sub> + I<sub>CC</sub>. C<sub>PD</sub> is used to determine the no-load dynamic power consumption; P<sub>D</sub> = C<sub>PD</sub> • V<sub>CC</sub><sup>2</sup> • f<sub>in</sub> + I<sub>CC</sub> • V<sub>CC</sub>.

# NLV74VHC1G132, NLV74VHC1GT132



$C_L$  includes probe and jig capacitance  
 $R_T$  is  $Z_{OUT}$  of pulse generator (typically 50  $\Omega$ )  
 $f = 1$  MHz

**Figure 3. Test Circuit**

Test	Switch Position	$C_L$ , pF	$R_L$ , $\Omega$
$t_{PLH} / t_{PHL}$	Open	See AC Characteristics Table	X
$t_{PLZ} / t_{PZL}$	$V_{CC}$		1 k
$t_{PHZ} / t_{PZH}$	GND		1 k

X = Don't Care

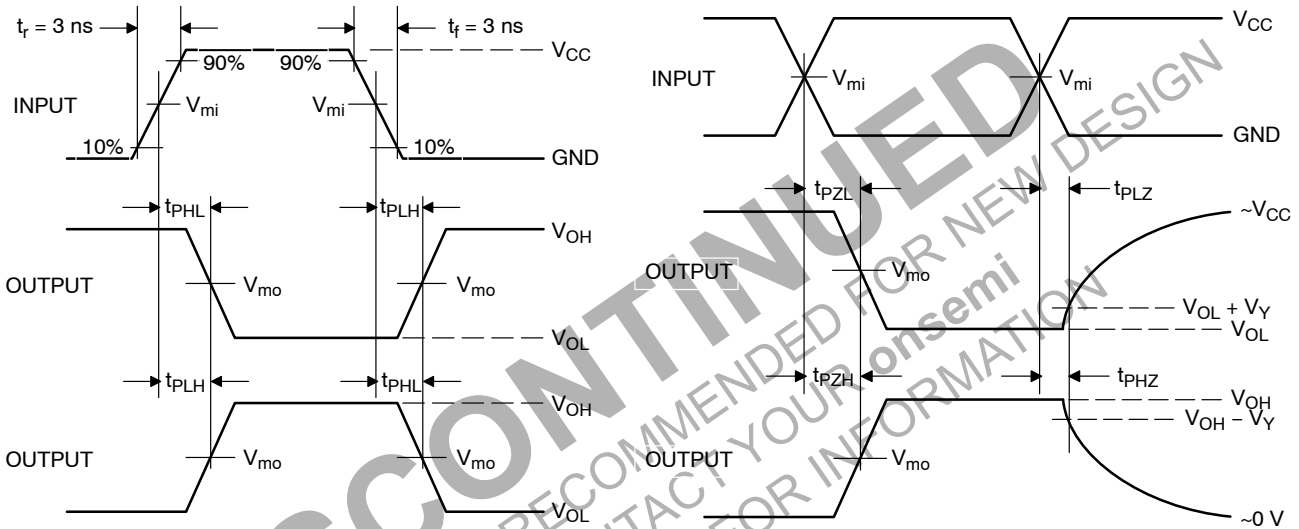

**Figure 4. Switching Waveforms**

$V_{CC}$ , V	$V_{mi}$ , V	$V_{mo}$ , V		$V_Y$ , V
		$t_{PLH}$ , $t_{PHL}$	$t_{PZL}$ , $t_{PLZ}$ , $t_{PZH}$ , $t_{PHZ}$	
3.0 to 3.6	$V_{CC}/2$	$V_{CC}/2$	$V_{CC}/2$	0.3
4.5 to 5.5	$V_{CC}/2$	$V_{CC}/2$	$V_{CC}/2$	0.3

## NLV74VHC1G132, NLV74VHC1GT132

### ORDERING INFORMATION

Device	Packages	Specific Device Code	Pin 1 Orientation (See below)	Shipping†
M74VHC1G132DFT2G-L22038	SC-88A	VD	Q4	3000 / Tape & Reel
NLVVHC1G132DFT1G*	SC-88A	VD	Q2	3000 / Tape & Reel
NLVVHC1G132DFT2G*	SC-88A	VD	Q4	3000 / Tape & Reel
M74VHC1G132DTT1G	TSOP-5	VD	Q4	3000 / Tape & Reel
NLVVHC1G132DTT1G*	TSOP-5	VD	Q4	3000 / Tape & Reel

†For information on tape and reel specifications, including part orientation and tape sizes, please refer to our Tape and Reel Packaging Specifications Brochure, BRD8011/D.

\*NLV Prefix for Automotive and Other Applications Requiring Unique Site and Control Change Requirements; AEC-Q100 Qualified and PPAP Capable.

### PIN 1 ORIENTATION IN TAPE AND REEL

Direction of Feed

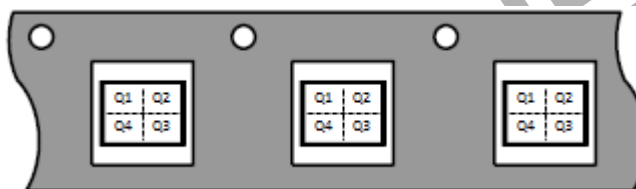

**DISCONTINUED**  
 THIS DEVICE IS NOT RECOMMENDED FOR NEW DESIGN  
 PLEASE CONTACT YOUR ONSEMI REPRESENTATIVE FOR INFORMATION

# MECHANICAL CASE OUTLINE PACKAGE DIMENSIONS



SCALE 2:1

## SC-88A (SC-70-5/SOT-353) CASE 419A-02 ISSUE M

DATE 11 APR 2023



### RECOMMENDED MOUNTING FOOTPRINT

\* For additional information on our Pb-Free strategy and soldering details, please download the ON Semiconductor Soldering and Mounting Techniques Reference Manual, SOLDERM/D.

### NOTES:

1. DIMENSIONING AND TOLERANCING PER ANSI Y14.5M, 1982.
2. CONTROLLING DIMENSION: MILLIMETERS
3. 419A-01 OBSOLETE. NEW STANDARD 419A-02
4. DIMENSIONS D AND E1 DO NOT INCLUDE MOLD FLASH, PROTRUSIONS, OR GATE BURRS. MOLD FLASH, PROTRUSIONS, OR GATE BURRS SHALL NOT EXCEED 0.1016MM PER SIDE.

DIM	MILLIMETERS		
	MIN.	NOM.	MAX.
A	0.80	0.95	1.10
A1	---	---	0.10
A3	0.20 REF		
b	0.10	0.20	0.30
c	0.10	---	0.25
D	1.80	2.00	2.20
E	2.00	2.10	2.20
E1	1.15	1.25	1.35
e	0.65 BSC		
L	0.10	0.15	0.30

### GENERIC MARKING DIAGRAM\*



\*This information is generic. Please refer to device data sheet for actual part marking. Pb-Free indicator, "G" or microdot "▪", may or may not be present. Some products may not follow the Generic Marking.

XXX = Specific Device Code

M = Date Code

▪ = Pb-Free Package

(Note: Microdot may be in either location)

#### STYLE 1:

1. BASE
2. EMITTER
3. BASE
4. COLLECTOR
5. COLLECTOR

#### STYLE 2:

1. ANODE
2. EMITTER
3. BASE
4. COLLECTOR
5. CATHODE

#### STYLE 3:

1. ANODE 1
2. N/C
3. ANODE 2
4. CATHODE 2
5. CATHODE 1

#### STYLE 4:

1. SOURCE 1
2. DRAIN 1/2
3. SOURCE 1
4. GATE 1
5. GATE 2

#### STYLE 5:

1. CATHODE
2. COMMON ANODE
3. CATHODE 2
4. CATHODE 3
5. CATHODE 4

#### STYLE 6:

1. EMITTER 2
2. BASE 2
3. EMITTER 1
4. COLLECTOR
5. COLLECTOR 2/BASE 1

#### STYLE 7:

1. BASE
2. EMITTER
3. BASE
4. COLLECTOR
5. COLLECTOR

#### STYLE 8:

1. CATHODE
2. COLLECTOR
3. N/C
4. BASE
5. EMITTER

#### STYLE 9:

1. ANODE
2. CATHODE
3. ANODE
4. ANODE
5. ANODE

Note: Please refer to datasheet for style callout. If style type is not called out in the datasheet refer to the device datasheet pinout or pin assignment.

<b>DOCUMENT NUMBER:</b>	<b>98ASB42984B</b>	Electronic versions are uncontrolled except when accessed directly from the Document Repository. Printed versions are uncontrolled except when stamped "CONTROLLED COPY" in red.
<b>DESCRIPTION:</b>	<b>SC-88A (SC-70-5/SOT-353)</b>	<b>PAGE 1 OF 1</b>

onsemi and ONSEMI are trademarks of Semiconductor Components Industries, LLC dba onsemi or its subsidiaries in the United States and/or other countries. onsemi reserves the right to make changes without further notice to any products herein. onsemi makes no warranty, representation or guarantee regarding the suitability of its products for any particular purpose, nor does onsemi assume any liability arising out of the application or use of any product or circuit, and specifically disclaims any and all liability, including without limitation special, consequential or incidental damages. onsemi does not convey any license under its patent rights nor the rights of others.



# MECHANICAL CASE OUTLINE PACKAGE DIMENSIONS

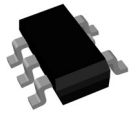

## TSOP-5 3.00x1.50x0.95, 0.95P CASE 483 ISSUE P

DATE 01 APR 2024

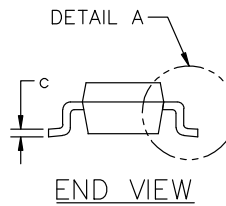
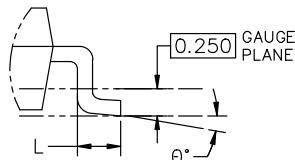

NOTES:

1. DIMENSIONING AND TOLERANCING CONFORM TO ASME Y14.5-2018.
2. ALL DIMENSION ARE IN MILLIMETERS (ANGLES IN DEGREES).
3. MAXIMUM LEAD THICKNESS INCLUDES LEAD FINISH THICKNESS. MINIMUM LEAD THICKNESS IS THE MINIMUM THICKNESS OF BASE MATERIAL.
4. DIMENSIONS D AND E1 DO NOT INCLUDE MOLD FLASH, PROTRUSIONS OF GATE BURRS. MOLD FLASH, PROTRUSIONS, OR GATE BURRS SHALL NOT EXCEED 0.15 PER SIDE. DIMENSION D.
5. OPTIONAL CONSTRUCTION: AN ADDITIONAL TRIMMED LEAD IS ALLOWED IN THIS LOCATION. TRIMMED LEAD NOT TO EXTEND MORE THAN 0.2 FROM BODY.

DIM	MILLIMETERS		
	MIN.	NOM.	MAX.
A	0.900	1.000	1.100
A1	0.010	0.055	0.100
A2	0.950 REF.		
b	0.250	0.375	0.500
c	0.100	0.180	0.260
D	2.850	3.000	3.150
E	2.500	2.750	3.000
E1	1.350	1.500	1.650
e	0.950 BSC		
L	0.200	0.400	0.600
θ	0°	5°	10°

### GENERIC MARKING DIAGRAM\*

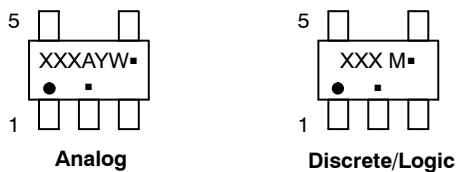

- XXX = Specific Device Code    XXX = Specific Device Code  
 A = Assembly Location        M = Date Code  
 Y = Year                        ▪ = Pb-Free Package  
 W = Work Week

▪ = Pb-Free Package  
(Note: Microdot may be in either location)

\*This information is generic. Please refer to device data sheet for actual part marking. Pb-Free indicator, "G" or microdot "▪", may or may not be present. Some products may not follow the Generic Marking.

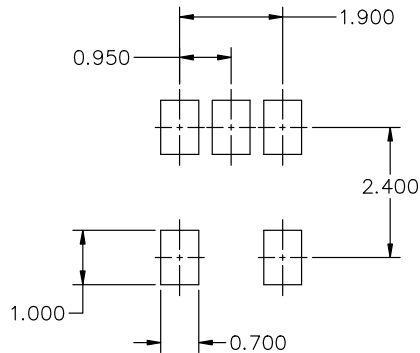

\* FOR ADDITIONAL INFORMATION ON OUR Pb-FREE STRATEGY AND SOLDERING DETAILS, PLEASE DOWNLOAD THE ON SEMICONDUCTOR SOLDERING AND MOUNTING TECHNIQUES REFERENCE MANUAL, SOLDERM/D.

<b>DOCUMENT NUMBER:</b>	<b>98ARB18753C</b>	Electronic versions are uncontrolled except when accessed directly from the Document Repository. Printed versions are uncontrolled except when stamped "CONTROLLED COPY" in red.
<b>DESCRIPTION:</b>	<b>TSOP-5 3.00x1.50x0.95, 0.95P</b>	<b>PAGE 1 OF 1</b>

onsemi and ONSEMI are trademarks of Semiconductor Components Industries, LLC dba onsemi or its subsidiaries in the United States and/or other countries. onsemi reserves the right to make changes without further notice to any products herein. onsemi makes no warranty, representation or guarantee regarding the suitability of its products for any particular purpose, nor does onsemi assume any liability arising out of the application or use of any product or circuit, and specifically disclaims any and all liability, including without limitation special, consequential or incidental damages. onsemi does not convey any license under its patent rights nor the rights of others.

**onsemi**, **Onsemi**, and other names, marks, and brands are registered and/or common law trademarks of Semiconductor Components Industries, LLC dba "**onsemi**" or its affiliates and/or subsidiaries in the United States and/or other countries. **onsemi** owns the rights to a number of patents, trademarks, copyrights, trade secrets, and other intellectual property. A listing of **onsemi**'s product/patent coverage may be accessed at [www.onsemi.com/site/pdf/Patent-Marking.pdf](http://www.onsemi.com/site/pdf/Patent-Marking.pdf). **onsemi** reserves the right to make changes at any time to any products or information herein, without notice. The information herein is provided "as-is" and **onsemi** makes no warranty, representation or guarantee regarding the accuracy of the information, product features, availability, functionality, or suitability of its products for any particular purpose, nor does **onsemi** assume any liability arising out of the application or use of any product or circuit, and specifically disclaims any and all liability, including without limitation special, consequential or incidental damages. Buyer is responsible for its products and applications using **onsemi** products, including compliance with all laws, regulations and safety requirements or standards, regardless of any support or applications information provided by **onsemi**. "Typical" parameters which may be provided in **onsemi** data sheets and/or specifications can and do vary in different applications and actual performance may vary over time. All operating parameters, including "Typicals" must be validated for each customer application by customer's technical experts. **onsemi** does not convey any license under any of its intellectual property rights nor the rights of others. **onsemi** products are not designed, intended, or authorized for use as a critical component in life support systems or any FDA Class 3 medical devices or medical devices with a same or similar classification in a foreign jurisdiction or any devices intended for implantation in the human body. Should Buyer purchase or use **onsemi** products for any such unintended or unauthorized application, Buyer shall indemnify and hold **onsemi** and its officers, employees, subsidiaries, affiliates, and distributors harmless against all claims, costs, damages, and expenses, and reasonable attorney fees arising out of, directly or indirectly, any claim of personal injury or death associated with such unintended or unauthorized use, even if such claim alleges that **onsemi** was negligent regarding the design or manufacture of the part. **onsemi** is an Equal Opportunity/Affirmative Action Employer. This literature is subject to all applicable copyright laws and is not for resale in any manner.

## ADDITIONAL INFORMATION

### TECHNICAL PUBLICATIONS:

Technical Library: [www.onsemi.com/design/resources/technical-documentation](http://www.onsemi.com/design/resources/technical-documentation)  
onsemi Website: [www.onsemi.com](http://www.onsemi.com)

### ONLINE SUPPORT: [www.onsemi.com/support](http://www.onsemi.com/support)

For additional information, please contact your local Sales Representative at [www.onsemi.com/support/sales](http://www.onsemi.com/support/sales)