

High speed thermal printhead (8 dots / mm)

NM2002-UA10A

The NM2002-UA10A is a flat thin-film thermal printhead with a built-in heat history control function, suited for general purpose compact printers as well as label printers with printing speeds up to 10 inch / second.

●Applications

- Bar code label printers
- Ticket printers
- General purpose compact printers

●Features

- 1) Special glazed components for high speed, high quality printing.
- 2) Our heat history control circuit reduces the load on the printer to control heat history.
- 3) Using a hard conductive film as a protective film on the heating element offers excellent resistance to electrostatic damage.

●External dimensions (Units: mm)

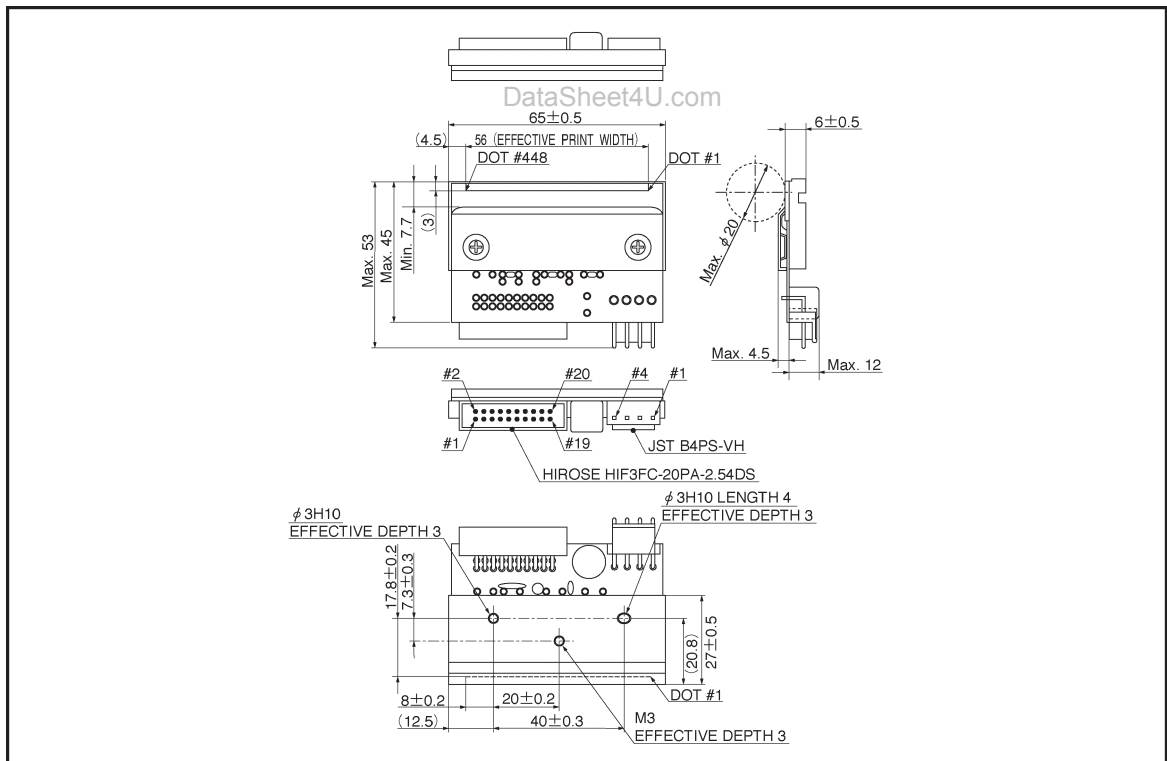

●Characteristics

Parameter	Symbol	Typical						Unit
Effective printing width	—	56						mm
Dot pitch	—	0.125						mm
Total dot number	—	448						dots
Average resistance value	Rave	550						Ω
Applied voltage	V _H	22.6						V
Applied power	P _O	0.8						W / dot
Print cycle	SLT	0.49						ms
Applied energy	LEVEL	1	2	3	4	5	6	—
	E _o	0.36	0.33	0.27	0.23	0.23	0.19	mJ / dot
Pulse width	Ton	0.45	0.41	0.34	0.29	0.29	0.24	ms
Maximum number of dots energized simultaneously	—	448						dots
Maximum clock frequency	—	5						MHz
Maximum roller diameter	—	20						mm
Running life / pulse life	—	50 / 10 ⁸						km / pulses
Operating temperature	—	5~45						°C

● Level Map

	Print Pattern	On Time	SLT=0.49ms
Level 1		Ton a	0.450 ms
Level 2		Ton b	0.410 ms
Level 3		Ton c	0.34 ms
Level 4		Ton d	0.29 ms
Level 5		Ton e	0.29 ms
Level 6		Ton f	0.240 ms

- : Heated dot.
- : Non-heated dot.
- : Dot to be printed.

This table shows a simple example. In actuality, the history of the previous level and the level before of the adjacent dots are included.

● Pin assignments

HIROSE

No.	Circuit	No.	Circuit
1	GND	11	CLK
2	N.C.	12	DI
3	N.C.	13	START
4	N.C.	14	LOAD
5	V _{DD}	15	RESET
6	V _{DD}	16	DO
7	INC	17	STB2
8	SET	18	STB1
9	E-OUT	19	TM
10	OR-ON	20	TM

JST

No.	Circuit
1	COM
2	COM
3	GND
4	GND

Added functions

SET: Sets all data to "HIGH". (Usable for preheating, etc.)

OR-ON: Set at "HIGH" when considering the adjoining of the previous columns; otherwise set at "LOW".

E-OUT: Outputs "HIGH" when a data transmission error occurs inside the head.

INC: Supports the increment function from level 1 to level 6. One level is incremented for one pulse. (See Fig. 2)

RESET: Sets all data at "LOW". Clears data when printing is resumed after a pause. (See Fig. 2)

Note: Signals of SET, INC, START, and RESET detect the falling edge; the START signal transmits data to the driver IC at the falling edge and latches at the rising edge.

For two-part split printing, enter INC after 34μ seconds of START7. (See Fig. 2)

● Timing chart

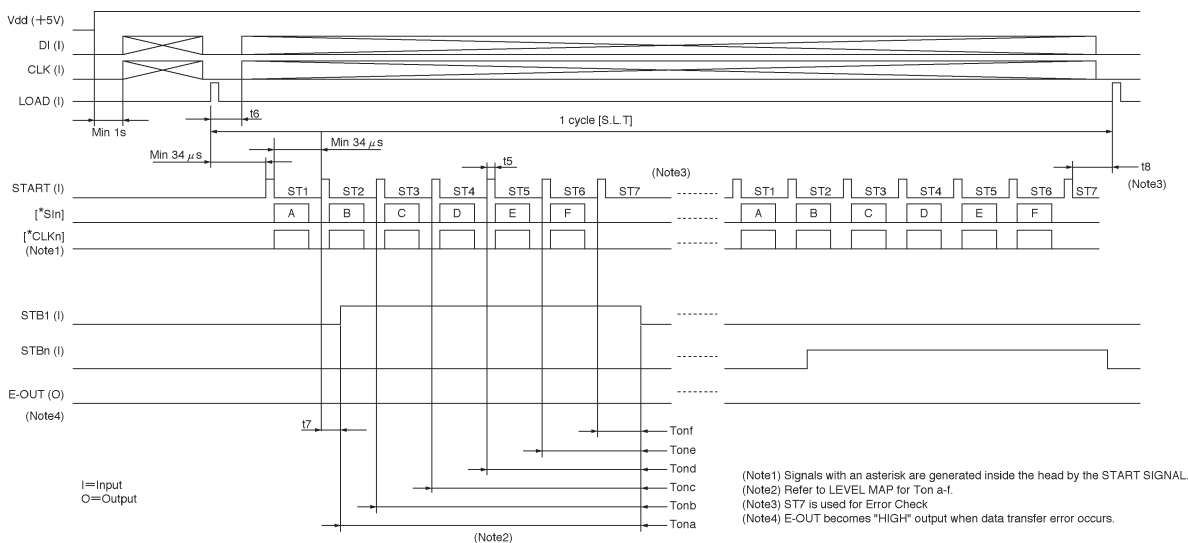

Fig.1

● Timing chart

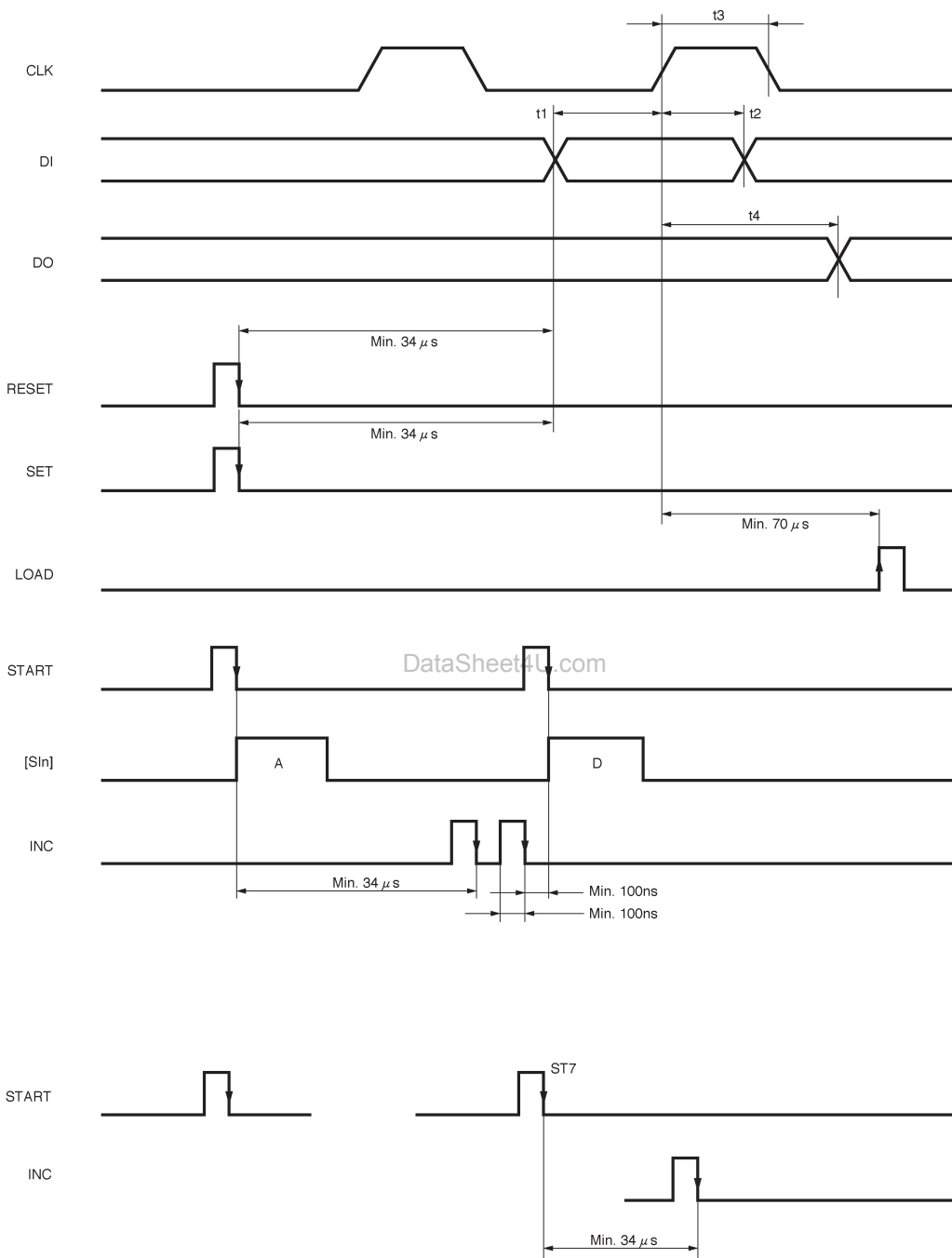

Fig.2

●Equivalent circuit

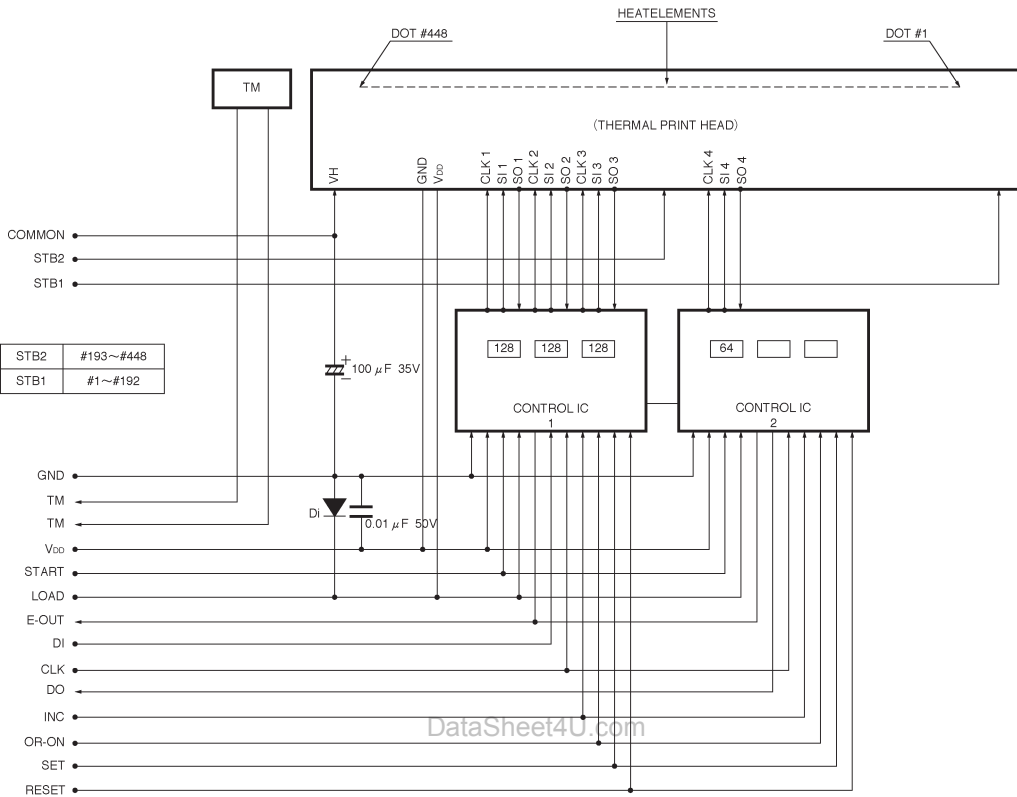
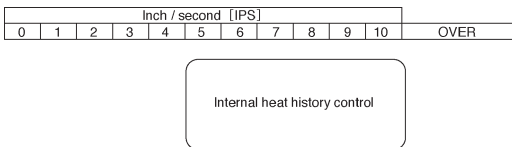

Fig. 3

●Supported speeds chart



● Electrical characteristic curves

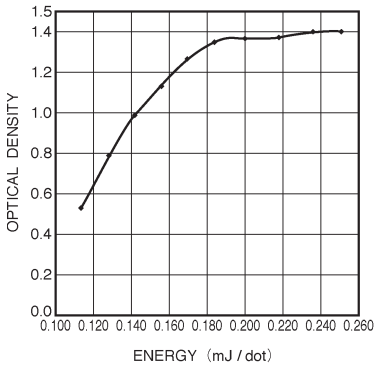

Fig. 4 Representative density curve

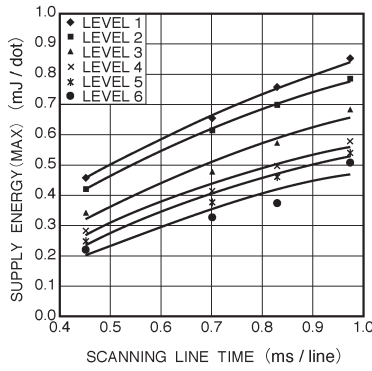

Fig. 5 Maximum energy curve

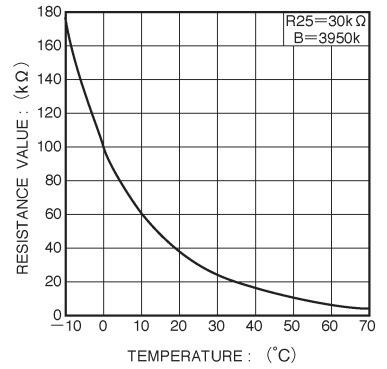

Fig. 6 Thermistor curve

et4U.com

DataSheet4U.com