

NOA1302

Ambient Light Sensor with I²C Interface

Description

The NOA1302 integrates a wide dynamic range ambient light sensor (ALS) with a 16-bit ADC and a 2-wire I²C digital interface. The NOA1302 ambient light sensor provides a linear response over the range of close to 0 lux to well over 100,000 lux with programmable integration times to optimize noise performance. The sensor employs proprietary CMOS image sensing technology from ON Semiconductor which provides low noise and high dynamic range output signals and light response similar to the response of the human eye.

The NOA1302 operates as an I²C slave device and supports commands to set options in the device and read out the ambient light intensity count.

Features

- Senses Ambient Light and Provides an Output Count Proportional to the Ambient Light Intensity
- Human Eye Type of Spectral Response
- Provides Comfortable Levels of Display Depending on the Viewing Environment
- Linear Response Over the Full Operating Range
- Senses Intensity of Ambient Light from ~0 Lux to over 100,000 Lux
- Programmable Integration Times of 400 ms, 200 ms and 100 ms
- No External Components Required
- Low Power Consumption
- Built-in 16-bit ADC
- I²C Serial Communication Port – Standard Mode – 100 kHz
– Fast Mode – 400 kHz
- This Device is Pb-Free, Halogen Free/BFR Free, and RoHS Compliant

Applications

- Saves Display Power in Applications such as:
 - Laptops, Notebooks, Digital Signage
 - LCD TVs and Monitors, Digital Picture Frames
 - LED Indoor/Outdoor Residential and Street Lights

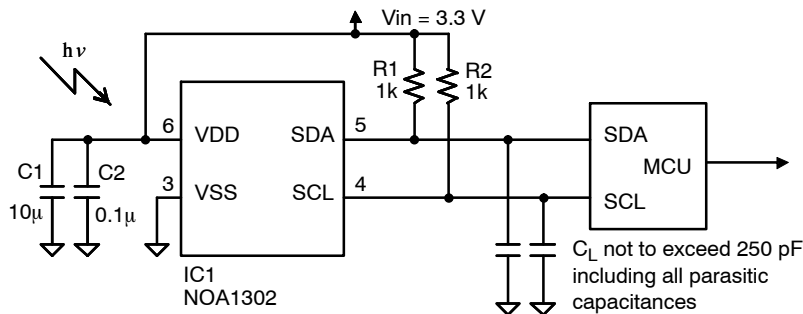

Figure 1. Typical Application Circuit



ON Semiconductor®

<http://onsemi.com>



CTSSOP-8
DC SUFFIX
CASE 949AA

MARKING DIAGRAM

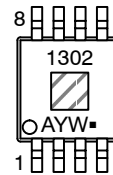

1302= Specific Device Code
A = Assembly Location
Y = Year
W = Work Week
▪ = Pb-Free Package

PIN ASSIGNMENT

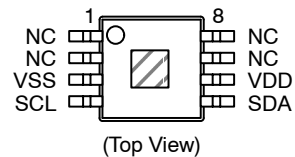

ORDERING INFORMATION

See detailed ordering and shipping information in the package dimensions section on page 2 of this data sheet.

NOA1302

Table 1. ORDERING INFORMATION

Part Number	Package	Shipping Configuration†	Temperature Range
NOA1302DCRG	CTSSOP-8 (Pb-Free)	2500 / Tape & Reel	0°C to 70°C

†For information on tape and reel specifications, including part orientation and tape sizes, please refer to our Tape and Reel Packaging Specification Brochure, BRD8011/D.

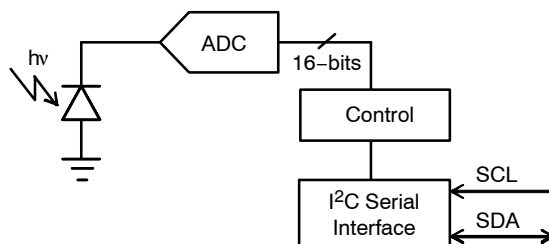

Figure 2. Simplified Block Diagram

Table 2. PIN FUNCTION DESCRIPTION

Pin	Pin Name	Description
1, 2, 7, 8	N/C	Not connected, leave this pin unconnected.
3	VSS	Ground pin.
4	SCL	External I²C clock supplied by the I²C master.
5	SDA	Bi-directional data signal for communications between this device and the I²C master.
6	VDD	Power pin.

Table 3. ABSOLUTE MAXIMUM RATINGS

Rating	Symbol	Value	Unit
Input power supply	VDD	5.5	V
Input voltage range	V _{in}	-0.3 to VDD + 0.2	V
Output voltage range	V _{out}	-0.3 to VDD + 0.2	V
Maximum Junction Temperature	T _{J(max)}	85	°C
Storage Temperature	T _{STG}	-40 to 85	°C
ESD Capability, Human Body Model (Note 1)	ESD _{HBM}	2.5	kV
ESD Capability, Charged Device Model (Note 1)	ESD _{CDM}	750	V
ESD Capability, Machine Model (Note 1)	ESD _{MM}	250	V
Moisture Sensitivity Level	MSL	3	-
Lead Temperature Soldering (Note 2)	T _{SLD}	260	°C

Stresses exceeding Maximum Ratings may damage the device. Maximum Ratings are stress ratings only. Functional operation above the Recommended Operating Conditions is not implied. Extended exposure to stresses above the Recommended Operating Conditions may affect device reliability.

- This device incorporates ESD protection and is tested by the following methods:
 - ESD Human Body Model tested per EIA/JESD22-A114
 - ESD Charged Device Model tested per ESD-STM5.3.1-1999
 - ESD Machine Model tested per EIA/JESD22-A115
 - Latchup Current Maximum Rating: ≤ 100 mA per JEDEC standard: JESD78
- For information, please refer to our Soldering and Mounting Techniques Reference Manual, SOLDERRM/D

NOA1302

Table 4. OPERATING RANGES

Rating	Symbol	Standard Mode		Fast Mode		Unit
		Min	Max	Min	Max	
Power supply voltage	VDD	3.0	3.6	3.0	3.6	V
Power supply current (VDD = 3.3 V)	IDD	325	950	325	950	μA
Low level input voltage (VDD related input levels)	V _{IL}	-0.3	0.3 VDD	-0.3	0.3 VDD	V
High level input voltage (VDD related input levels)	V _{IH}	0.7 VDD	VDD + 0.2	0.7 VDD	VDD + 0.2	V
Hysteresis of Schmitt trigger inputs (VDD > 2 V)	V _{hys}	N/A	N/A	0.05 VDD	-	V
Low level output voltage (open drain) at 3 mA sink current (VDD > 2 V)	V _{OL}	0	0.4	0	0.4	V
High level output voltage (with 1 kΩ pullup resistance) at and output current of -20 μA (VDD > 2 V)	V _{OH}	VDD - 0.1	N/A	VDD - 0.1	N/A	V
Input current of IO pin with an input voltage between 0.1 VDD and 0.9 VDD	I _I	-10	10	-10	10	μA
Output low current	I _{OL}	-	45	-	45	mA
Capacitance on IO pin	C _I	-	10	-	10	pF
Operating free-air temperature range	T _A	0	70	0	70	°C

Table 5. ELECTRICAL CHARACTERISTICS

(Unless otherwise specified, these specifications apply over VDD = 3.3 V, 0°C < T_A < 70°C) (Note 3)

Parameter	Symbol	Standard Mode		Fast Mode		Unit
		Min	Max	Min	Max	
SCL clock frequency	f _{SCL}	10	100	100	400	kHz
Hold time for START condition. After this period, the first clock pulse is generated.	t _{HD;STA}	4.0	-	0.6	-	μS
Low period of SCL clock	t _{LOW}	4.7		1.3		μS
High period of SCL clock	t _{HIGH}	4.0		0.6		μS
Data hold time for I ² C-bus devices	t _{HD;DAT_d}	0	3.45	0	0.9	μS
Data set-up time	t _{SU;DAT}	250	-	100	-	nS
Rise time of both SDA and SCL (input signals) (Note 4)	t _{r_INPUT}	5	300	5	300	nS
Fall time of both SDA and SCL (input signals) (Note 4)	t _{f_INPUT}	5	300	5	300	nS
Rise time of SDA output signal (Note 4)	t _{r_OUT}	-	1000	-	1000	nS
Fall time of SDA output signal (Note 4)	t _{f_OUT}	-	1000	-	1000	nS
Output fall time from V _{IHmin} to V _{ILmax} with a bus capacitance from 10 pF to 250 pF. (Note 5)	t _{of}	2	250	2	250	nS
Set-up time for STOP condition	t _{SU;STO}	4.0	-	0.6	-	μS
Bus free time between STOP and START condition	t _{BUF}	4.7	-	1.3	-	μS
Capacitive load for each bus line (including all parasitic capacitance)	C _L	-	250	-	250	pF
Noise margin at the low level for each connected device (including hysteresis)	V _{nL}	0.1 VDD	-	0.1 VDD	-	V
Noise margin at the high level for each connected device (including hysteresis)	V _{nH}	0.2 VDD	-	0.2 VDD	-	V

3. Refer to Figure 3 for more information on AC characteristics

4. The rise time and fall time are measured with a pull-up resistor R_p = 1 kΩ and C_b of 250 pF (including all parasitic capacitances).

5. C_b = capacitance of one bus line, maximum value of which including all parasitic capacitances should be less than 250 pF.

NOA1302

Table 6. OPTICAL CHARACTERISTICS (Unless otherwise specified, these specifications are for VDD = 3.3 V, T_A = 25°C)

Parameter	Test Conditions	Symbol	Min	Typ	Max	Unit
Irradiance responsivity	λ_p (see Figure 5)	R _e		545		nM
Illuminance responsivity	Incandescent light source: Ev = 100 lux (see Figure 6)	R _v		150		Counts
	Incandescent light source: Ev = 1000 lux (see Figure 6)			1480		
Illuminance responsivity	Fluorescent light source: Ev = 100 lux (see Figure 7)	R _v		130		Counts
	Fluorescent light source: Ev = 1000 lux (see Figure 7)			1290		
Dark current	Ev = 0 lux (see Figure 9)			2		Counts

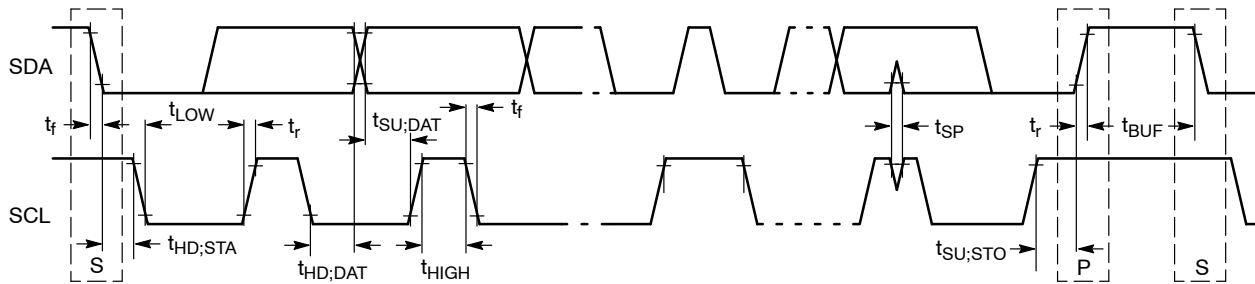

Figure 3. AC Characteristics

TYPICAL CHARACTERISTICS

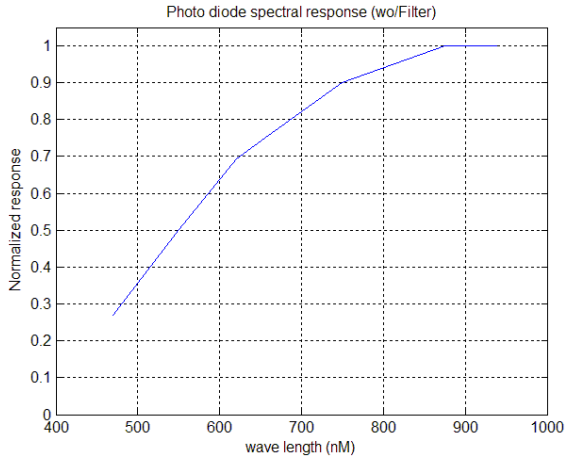

Figure 4. Photo Diode Spectral Response (Without Filter)

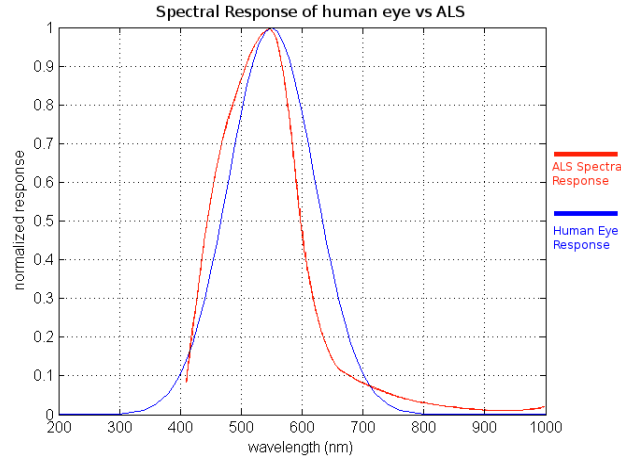

Figure 5. Human Eye vs. NOA1302 Spectral Response

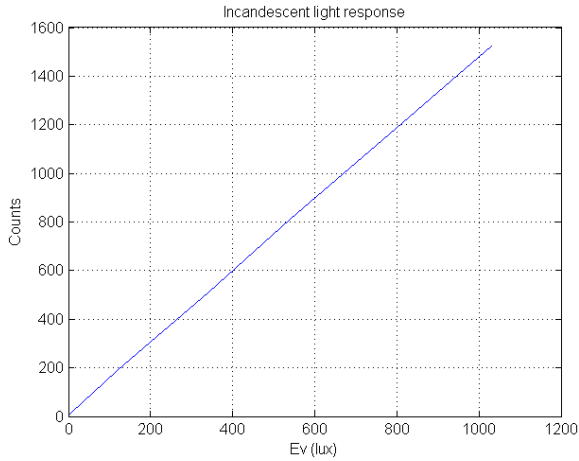

Figure 6. Incandescent Light Response (200 ms Integration)

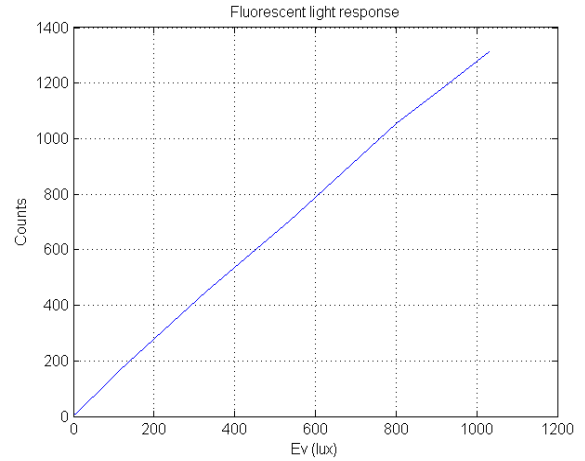

Figure 7. Fluorescent Light Response (200 ms Integration)

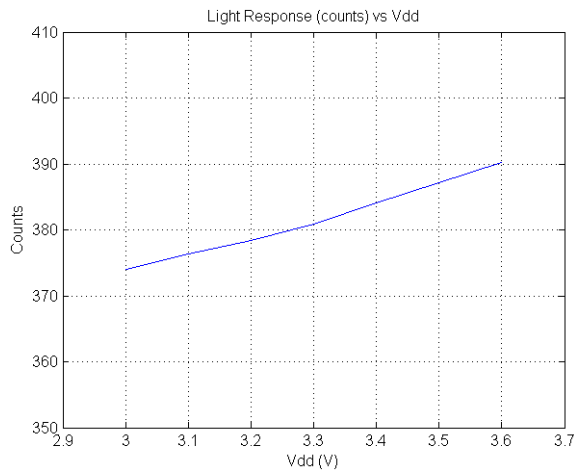

Figure 8. Light Response vs. VDD

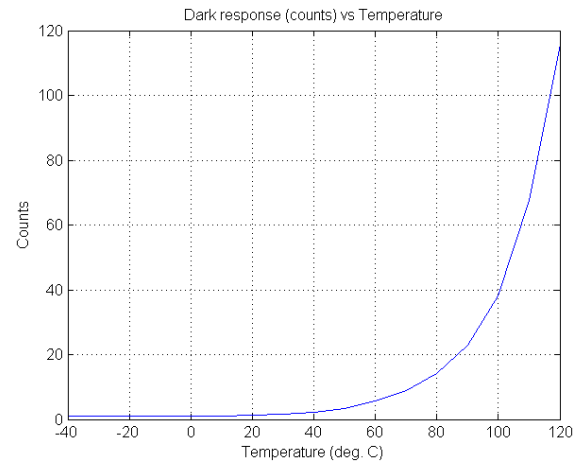

Figure 9. Dark Counts vs. Temperature (200 ms Integration)

TYPICAL CHARACTERISTICS

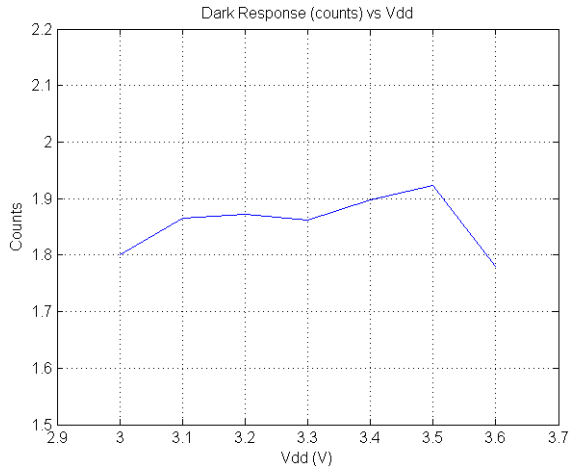

Figure 10. Dark Counts vs. Vdd

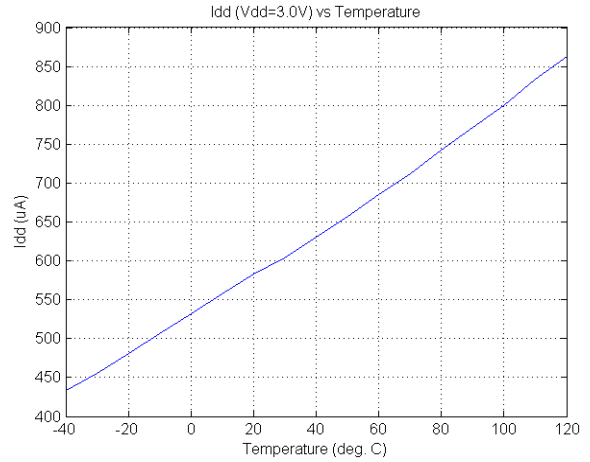

Figure 11. Idd vs. Temperature

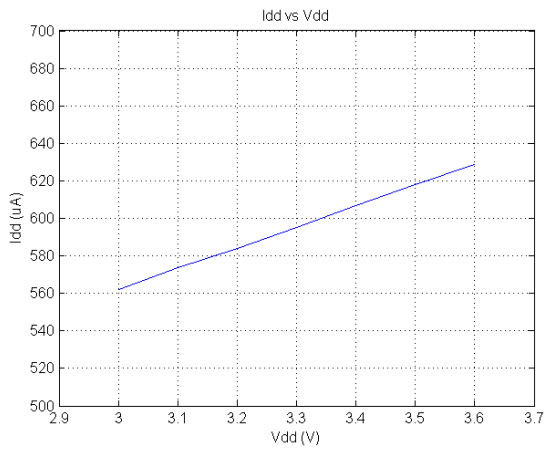

Figure 12. Idd vs.Vdd

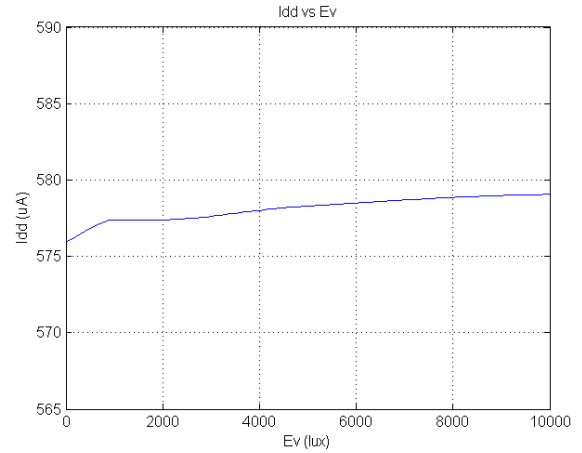

Figure 13. Idd vs Ev

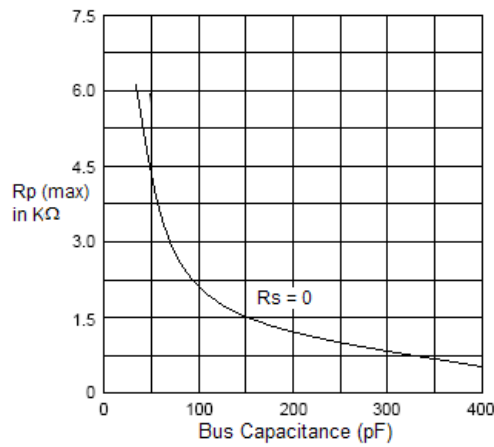

Figure 14. Maximum Value of Rp (in kΩ) as a function of Bus Capacitance (in pF)

DESCRIPTION OF OPERATION

Ambient Light Sensor Architecture

The NOA1302 employs a sensitive photo diode fabricated in ON Semiconductor's standard CMOS process technology. The major components of this sensor are as shown in Figure 2. The photons which are to be detected pass through an ON Semiconductor proprietary color filter limiting extraneous photons and thus performing as a band pass filter on the incident wave front. The filter only transmits photons in the visible spectrum which are primarily detected by the human eye. The photo response of this sensor is as shown in Figure 5.

The ambient light signal detected by the photo diode is converted to digital signal using a *variable slope integrating* ADC with a resolution of 16-bits, unsigned. The ADC value is provided to the control block connected to the I²C interface block.

Equation 1 shows the relationship of output counts C_{nt} as a function of integration constant I_k , integration time T_{int} (in seconds) and the intensity of the ambient light, I_L (in lux), at room temperature (25°C).

$$I_L = \frac{C_{nt}}{(I_k \cdot T_{int})} \quad (\text{eq. 1})$$

Where:

$I_k = 6.67$ (for fluorescent light)

$I_k = 7.5$ (for incandescent light)

Hence the intensity of the ambient fluorescent light (in lux):

$$I_L = \frac{C_{nt}}{(6.67 \cdot T_{int})} \quad (\text{eq. 2})$$

and the intensity of the ambient incandescent light (in lux):

$$I_L = \frac{C_{nt}}{(7.5 \cdot T_{int})} \quad (\text{eq. 3})$$

For example let:

$C_{nt} = 1200$

$T_{int} = 200 \text{ mS}$

Intensity of ambient incandescent light, I_L (in lux):

$$I_L = \frac{1200}{(7.5 \cdot 200 \text{ mS})} \quad (\text{eq. 4})$$

$I_L = 800 \text{ lux}$

I²C Interface

The NOA1302 operates on the I²C bus as a slave device. The I²C address is fixed at 0x39 (hexadecimal 39). Registers can be programmed by sending commands over an I²C bus. Ambient light intensity count value can be obtained by reading registers. The ambient light intensity count is 16 bits, hence two I²C read operations are needed. This device supports both standard (100 Kbit/s) and fast mode (400 Kbit/s) of operation on the I²C bus.

Figure 15 shows an I²C write operation. To write to an internal register of the NOA1302 a write command must be sent by an I²C master. The write command begins with a start condition. After the start condition, seven bits of address are

sent MSB first. RD/WR_ command bit follows the address bits. Upon receiving a valid address the device responds by driving SDA low for an ACK. After receiving an ACK, the I²C master sends eight bits of data with MSB first. Upon receiving eight bits of data the NOA1302 generates an ACK. The I²C master terminates this write command with a stop condition.

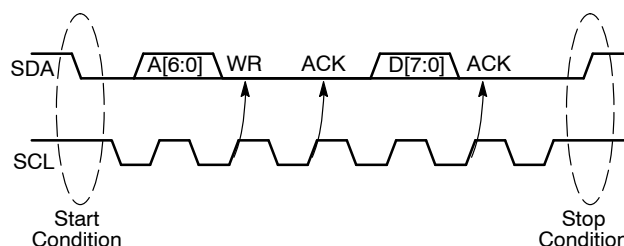

Figure 15. I²C Write Command

Figure 16 shows an I²C read command sent by the master to the slave device. The I²C read command begins with a start condition. After the start condition, seven bits of address are sent by the master MSB first, followed by the RD/WR_ command bit. For a read command the RD/WR_ bit is high. Upon receiving the address bits and RD/WR_ command bits the device responds with an ACK. After sending an ACK, the device sends eight bits of data MSB first. After receiving the data, the master terminates this transaction by issuing a NACK command to indicate that the master only wanted to read one byte from the device. The master generates a stop condition to end this transaction. Repeated START condition is not supported. Each I²C transaction must be terminated with a STOP condition after all required bits have been transmitted and received.

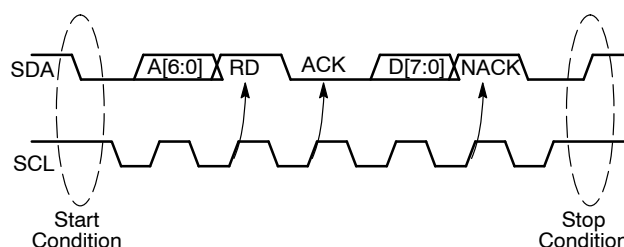

Figure 16. I²C Read Command

Programmer's Model

Ambient light intensity count is obtained from the the NOA1302 by issuing a fixed sequence of I²C commands. Integration time is programmable by writing different values to the integration time register. The following sections describe what a programmer needs to know about issuing commands to the chip and register access.

Integration Time Register

Table 7 describes integration time register which controls the exposure time. This register has three bits, EC[2:0] which control the duration of the integration time.

Table 7. INTEGRATION TIME REGISTER

EC[2,1,0]	Operation	Integration Time
000	Normal mode of operation	400 ms
001	Normal mode of operation	200 ms (Default)
010	Normal mode of operation	100 ms
011	Test mode	16.7 ms
100	Simulation test mode use only	1.0 ms
101	Reserved for future use	
110	Reserved for future use	
111	Reserved for future use	

Programming Sequence and Command Summary

This section describes supported commands and programming sequence. The NOA1302 only supports single byte write and a single byte read I²C commands. Ambient light intensity count is 16 bits wide, thus two I²C read commands are needed.

Table 8 describes supported commands. All of these commands have to be sent to the fixed address (0x39).

Table 8. DEVICE COMMANDS

Command	Function
0x00h	Start reading ADC data
0x03h	Complete reading ADC data
0x1Dh	Change EC[0] to 0
0x18h	Reset EC[2:0] to default value (001)
0x43h	Prepare ADC LS byte for reading
0x83h	Prepare ADC MS byte for reading
0x88h	Change EC[1] to 1
0x90h	Change EC[2] to 1

Programming Sequence

To read 16 bits wide ambient light intensity count, the following commands must be issued in sequence:

1. Send write command 0x00h to start the ADC conversion cycle.
2. Send write command 0x03h to complete the ADC cycle.
3. Send write command 0x43h to prepare the LS byte for reading.
4. Send read byte command, returns LS byte of count.
5. Send write command 0x83h to prepare the MS byte for reading.
6. Send read byte command, returns MS byte of count.

To change the integration time, for example to 100 ms, the following commands must be used in sequence:

1. Send write command 0x1Dh to set EC[0] = 0.
2. Send write command 0x88h to set EC[1] = 1, now EC[2:0] = 010.

Rise and Fall Time of SDA (Output)

Proper operation of the I²C bus depends on keeping the bus capacitance low and selecting suitable pull-up resistor values. Figure 17 and Figure 18 show the rise and fall time on SDA in output mode under maximum load conditions. The measurement set-up is shown in Figure 19. Figure 14 shows the maximum value of the pull-up resistor (R_p) as a function of the I²C data bus capacitance.

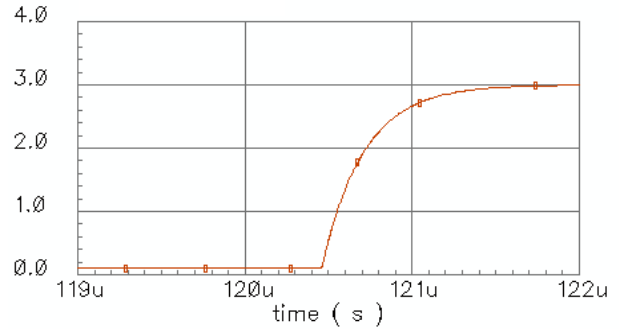

R_p = 1 kΩ
 C_L = 250 pF (including all parasitic caps)
 t_r = 530 ns

Figure 17. SDA Rise Time (t_r)

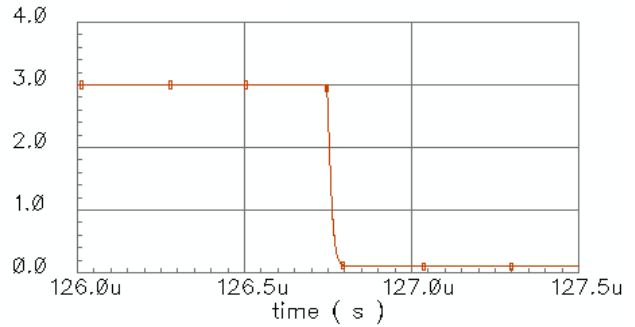

R_p = 1 kΩ
 C_L = 250 pF (including all parasitic caps)
 t_f = 21 ns

Figure 18. SDA Fall Time (t_f)

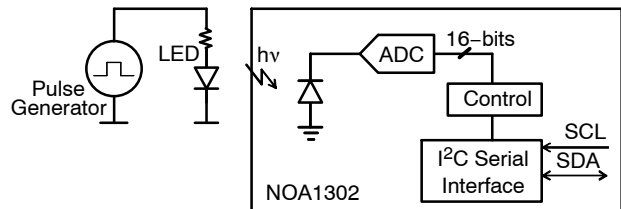
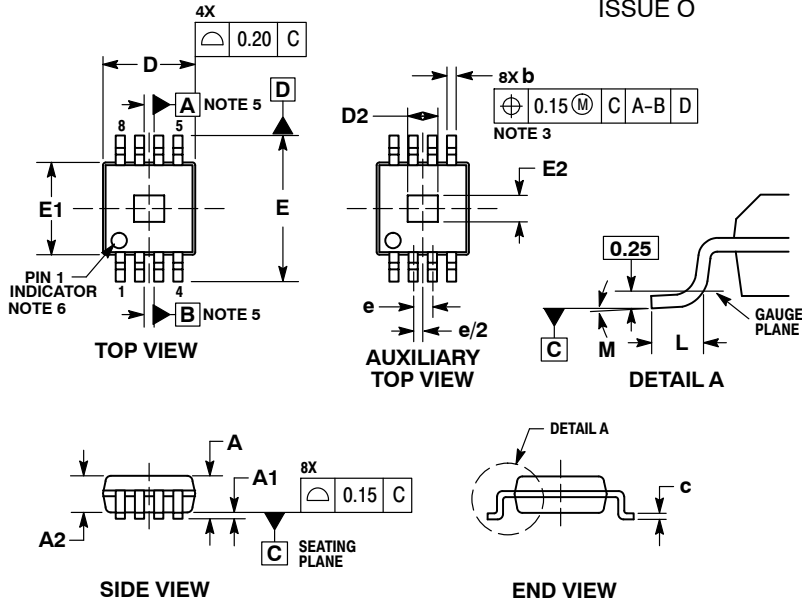

Figure 19. Measurement Set-up

NOA1302

PACKAGE DIMENSIONS

CTSSOP8 3x3
CASE 949AA-01
ISSUE O



- NOTES:
1. DIMENSIONING AND TOLERANCING PER ASME Y14.5M, 1994.
 2. CONTROLLING DIMENSION: MILLIMETER.
 3. DIMENSION b DOES NOT INCLUDE DAMBAR PROTRUSION AND IS DETERMINED BETWEEN 0.08 AND 0.15 MM FROM THE LEAD TIP.
 4. DIMENSIONS D AND E1 DOES NOT INCLUDE MOLD PROTRUSIONS, TIE BAR BURRS, GATE BURRS OR FLASH. END FLASH SHALL NOT EXCEED 0.25 PER SIDE. DIMENSIONS D AND E1 DO INCLUDE ANY MOLD CAVITY MISMATCH AND ARE DETERMINED AT THE GAUGE PLANE.
 5. DATUMS A AND B TO BE DETERMINED AT THE GAUGE PLANE.
 6. DETAILS OF THE PIN 1 IDENTIFIER ARE OPTIONAL, BUT MUST BE LOCATED WITHIN THIS ZONE.

DIM	MILLIMETERS	
	MIN	MAX
A	---	1.10
A1	0.00	0.14
A2	0.73	0.93
b	0.24	0.39
c	0.13	0.24
D	3.00 BSC	
D2	0.66	1.37
E	4.90 BSC	
E1	3.00 BSC	
E2	0.41	1.37
e	0.65 BSC	
L	0.39	0.67
M	0°	8°

SOLDERING FOOTPRINT*

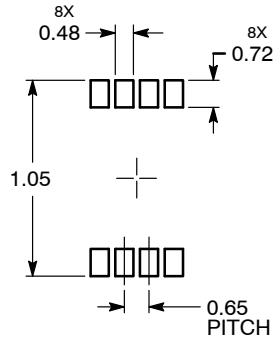

DIMENSIONS: MILLIMETERS

*For additional information on our Pb-Free strategy and soldering details, please download the ON Semiconductor Soldering and Mounting Techniques Reference Manual, SOLDERRM/D.

ON Semiconductor and are registered trademarks of Semiconductor Components Industries, LLC (SCILLC). SCILLC reserves the right to make changes without further notice to any products herein. SCILLC makes no warranty, representation or guarantee regarding the suitability of its products for any particular purpose, nor does SCILLC assume any liability arising out of the application or use of any product or circuit, and specifically disclaims any and all liability, including without limitation special, consequential or incidental damages. "Typical" parameters which may be provided in SCILLC data sheets and/or specifications can and do vary in different applications and actual performance may vary over time. All operating parameters, including "Typicals" must be validated for each customer application by customer's technical experts. SCILLC does not convey any license under its patent rights nor the rights of others. SCILLC products are not designed, intended, or authorized for use as components in systems intended for surgical implant into the body, or other applications intended to support or sustain life, or for any other application in which the failure of the SCILLC product could create a situation where personal injury or death may occur. Should Buyer purchase or use SCILLC products for any such unintended or unauthorized application, Buyer shall indemnify and hold SCILLC and its officers, employees, subsidiaries, affiliates, and distributors harmless against all claims, costs, damages, and expenses, and reasonable attorney fees arising out of, directly or indirectly, any claim of personal injury or death associated with such unintended or unauthorized use, even if such claim alleges that SCILLC was negligent regarding the design or manufacture of the part. SCILLC is an Equal Opportunity/Affirmative Action Employer. This literature is subject to all applicable copyright laws and is not for resale in any manner.

PUBLICATION ORDERING INFORMATION

LITERATURE FULFILLMENT:
Literature Distribution Center for ON Semiconductor
P.O. Box 5163, Denver, Colorado 80217 USA
Phone: 303-675-2175 or 800-344-3860 Toll Free USA/Canada
Fax: 303-675-2176 or 800-344-3867 Toll Free USA/Canada
Email: orderlit@onsemi.com

N. American Technical Support: 800-282-9855 Toll Free
USA/Canada
Europe, Middle East and Africa Technical Support:
Phone: 421 33 790 2910
Japan Customer Focus Center
Phone: 81-3-5773-3850

ON Semiconductor Website: www.onsemi.com
Order Literature: <http://www.onsemi.com/orderlit>
For additional information, please contact your local Sales Representative