

NP45N06VUK, NP45N06PUK

60 V – 45 A – N-channel Power MOS FET

Application: Automotive

R07DS0953EJ0200

Rev.2.00

May 24, 2018

Description

These products are N-channel MOS Field Effect Transistors designed for high current switching applications.

Features

- Super low on-state resistance
 $R_{DS(on)} = 9.6 \text{ m}\Omega \text{ MAX. (} V_{GS} = 10 \text{ V, } I_D = 23 \text{ A)}$
- Low C_{iss} : $C_{iss} = 1690 \text{ pF TYP. (} V_{DS} = 25 \text{ V)}$
- Designed for automotive application and AEC-Q101 qualified

Ordering Information

Part No.	Lead Plating	Packing		Package
NP45N06VUK-E1-AY *1	Pure Sn (Tin)	Tape 2500 p/reel	Taping (E1 type)	TO-252 (MP-3ZP)
NP45N06VUK-E2-AY *1			Taping (E2 type)	
NP45N06PUK-E1-AY *1		Tape 800 p/reel	Taping (E1 type)	TO-263 (MP-25ZP)
NP45N06PUK-E2-AY *1			Taping (E2 type)	

Note: *1 Pb-free (This product does not contain Pb in the external electrode)

Absolute Maximum Ratings ($T_A = 25^\circ\text{C}$)

Item	Symbol	Ratings	Unit	
Drain to Source Voltage ($V_{GS} = 0 \text{ V}$)	V_{DSS}	60	V	
Gate to Source Voltage ($V_{DS} = 0 \text{ V}$)	V_{GSS}	± 20	V	
Drain Current (DC) ($T_C = 25^\circ\text{C}$)	$I_{D(DC)}$	± 45	A	
Drain Current (pulse) *1, 3	$I_{D(pulse)}$	± 135	A	
Total Power Dissipation ($T_C = 25^\circ\text{C}$)	P_{T1}	75	W	
Total Power Dissipation ($T_A = 25^\circ\text{C}$)	NP45N06VUK	P_{T2}	1.2	W
	NP45N06PUK		1.8	W
Channel Temperature	T_{ch}	175	$^\circ\text{C}$	
Storage Temperature	T_{stg}	-55 to +175	$^\circ\text{C}$	
Repetitive Avalanche Current *2, 3	I_{AR}	19	A	
Repetitive Avalanche Energy *2, 3	E_{AR}	36	mJ	

Thermal Resistance

Channel to Case Thermal Resistance	$R_{th(ch-C)}$ *3		2.00 $^\circ\text{C/W}$
Channel to Ambient Thermal Resistance	$R_{th(ch-A)}$ *3	NP45N06VUK	125 $^\circ\text{C/W}$
		NP45N06PUK	83.3 $^\circ\text{C/W}$

Notes: *1 $T_C = 25^\circ\text{C}$, $P_w \leq 10 \mu\text{s}$, Duty Cycle $\leq 1\%$

*2 $R_G = 25 \Omega$, $V_{GS} = 20 \text{ V} \rightarrow 0 \text{ V}$

*3 Not subject of production test. Verified by design/characterization.

Electrical Characteristics (T_A = 25°C)

Item	Symbol	MIN.	TYP.	MAX.	Unit	Test Conditions
Zero Gate Voltage Drain Current	I _{DSS}	—	—	1	μA	V _{DS} = 60 V, V _{GS} = 0 V
Gate Leakage Current	I _{GSS}	—	—	±100	nA	V _{GS} = ±20 V, V _{DS} = 0 V
Gate to Source Threshold Voltage	V _{GS(th)}	2.0	3.0	4.0	V	V _{DS} = V _{GS} , I _D = 250 μA
Forward Transfer Admittance *1	y _{fs}	17	34	—	S	V _{DS} = 5 V, I _D = 23 A
Drain to Source On-state Resistance *1	R _{DS(on)}	—	7.8	9.6	mΩ	V _{GS} = 10 V, I _D = 23 A
Input Capacitance *2	C _{iss}	—	1690	2540	pF	V _{DS} = 25 V V _{GS} = 0 V f = 1 MHz
Output Capacitance *2	C _{oss}	—	155	240	pF	
Reverse Transfer Capacitance *2	C _{rss}	—	70	130	pF	
Turn-on Delay Time *2	t _{d(on)}	—	15	40	ns	V _{DD} = 30 V, I _D = 23 A V _{GS} = 10 V R _G = 0 Ω
Rise Time *2	t _r	—	5	20	ns	
Turn-off Delay Time *2	t _{d(off)}	—	37	80	ns	
Fall Time *2	t _f	—	3	10	ns	
Total Gate Charge *2	Q _G	—	30	45	nC	V _{DD} = 48 V V _{GS} = 10 V I _D = 45 A
Gate to Source Charge	Q _{GS}	—	8	—	nC	
Gate to Drain Charge	Q _{GD}	—	8	—	nC	
Body Diode Forward Voltage *1	V _{F(S-D)}	—	0.9	1.5	V	I _F = 45 A, V _{GS} = 0 V
Reverse Recovery Time	t _{rr}	—	32	—	ns	I _F = 45 A, V _{GS} = 0 V
Reverse Recovery Charge	Q _{rr}	—	35	—	nC	di/dt = 100 A/μs

Note: *1 Pulsed test

Note: *2 Not subject of production test. Verified by design/characterization.

TEST CIRCUIT 1 AVALANCHE CAPABILITY

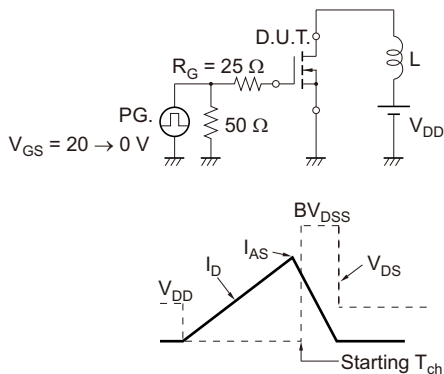

TEST CIRCUIT 2 SWITCHING TIME

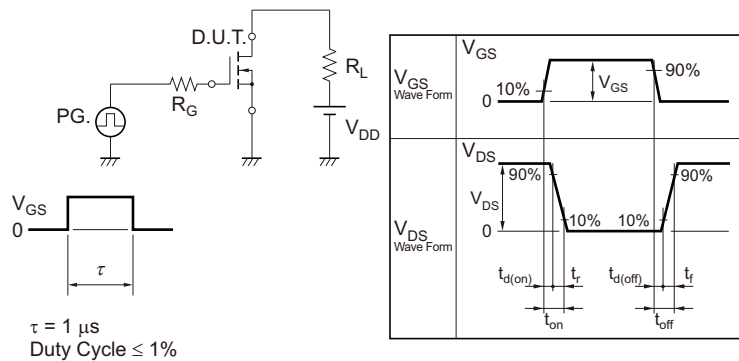

TEST CIRCUIT 3 GATE CHARGE

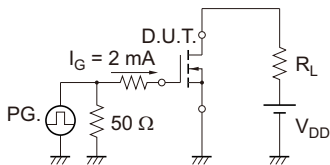

Typical Characteristics (T_A = 25°C)

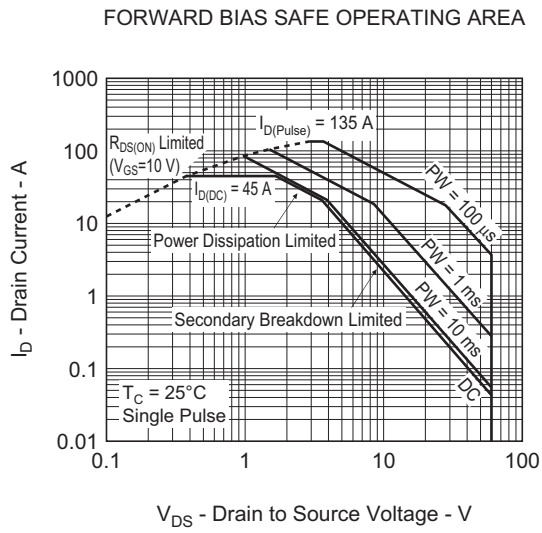
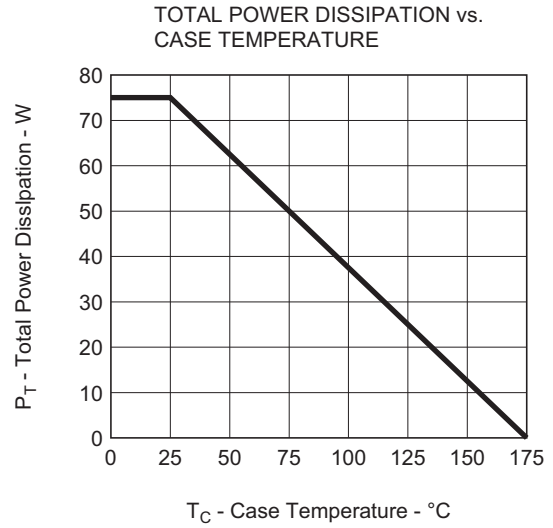
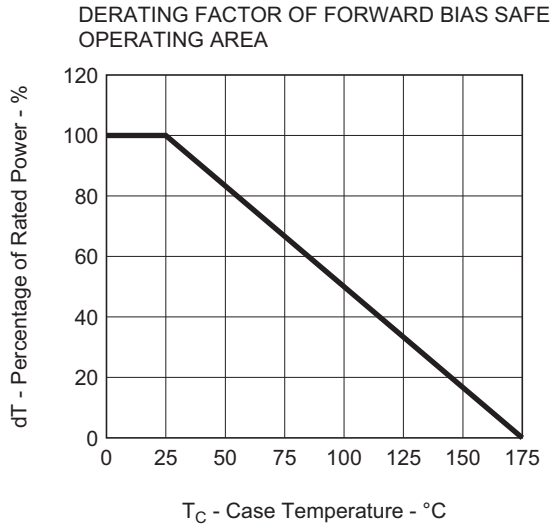

TRANSIENT THERMAL RESISTANCE vs. PULSE WIDTH (NP45N06VUK)

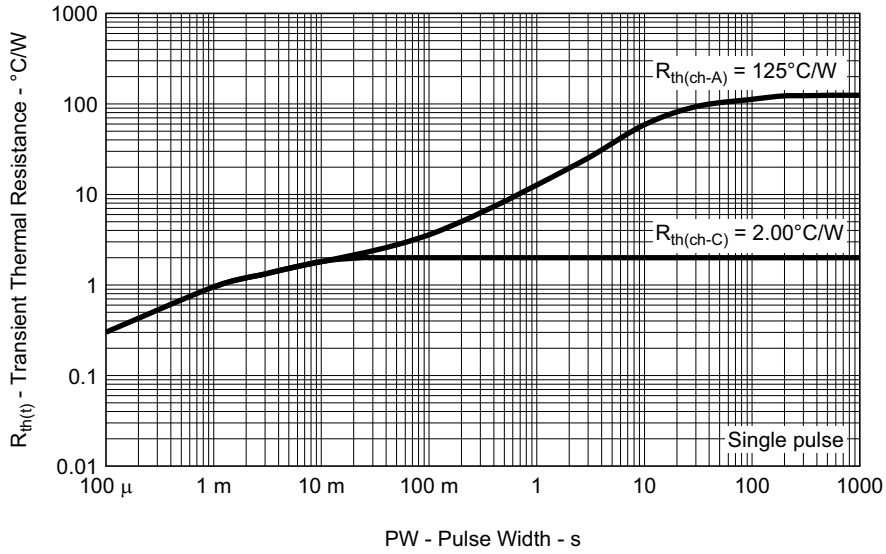

TRANSIENT THERMAL RESISTANCE vs. PULSE WIDTH (NP45N06PUK)

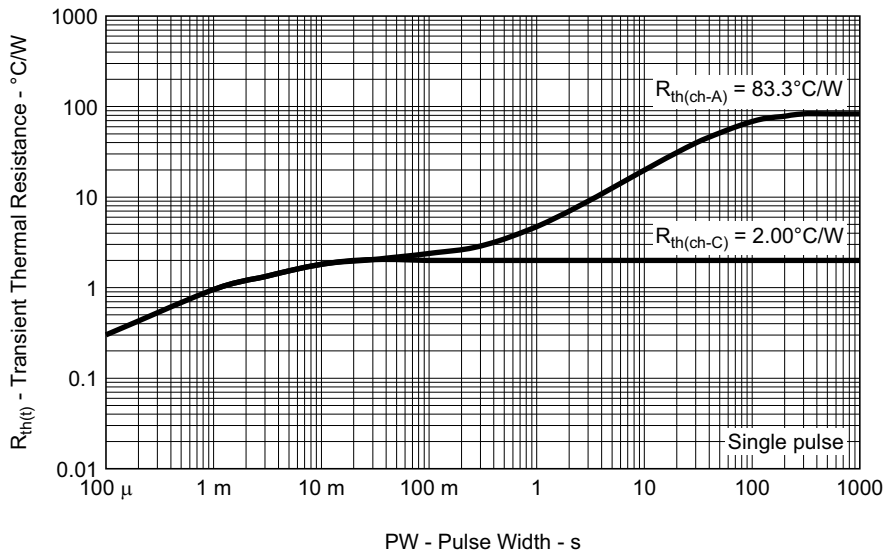

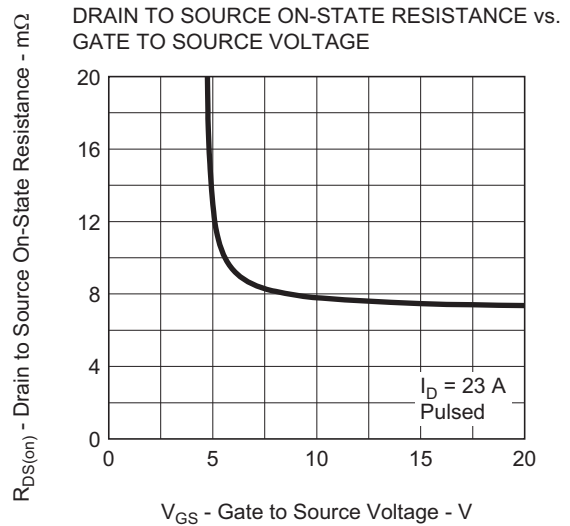
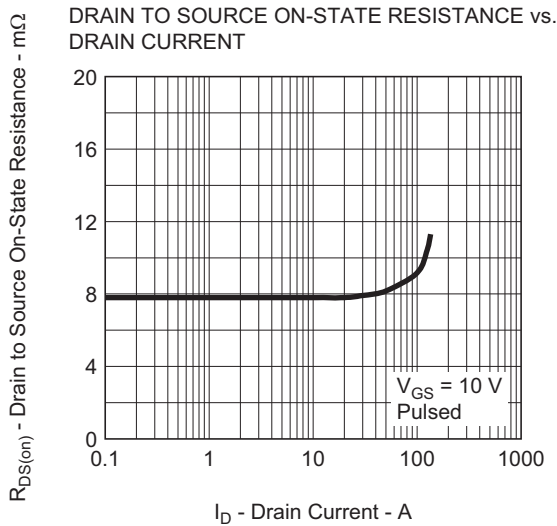
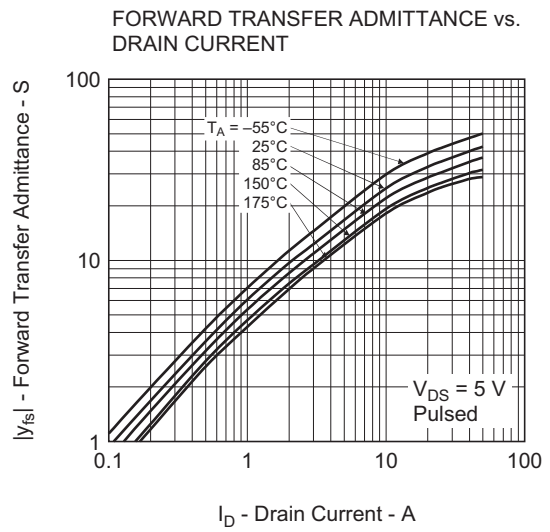
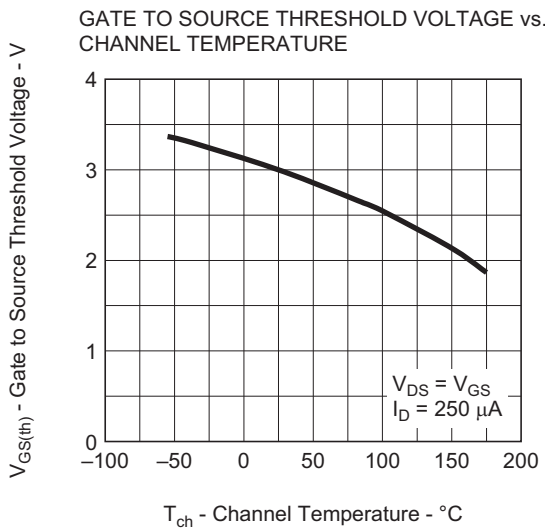
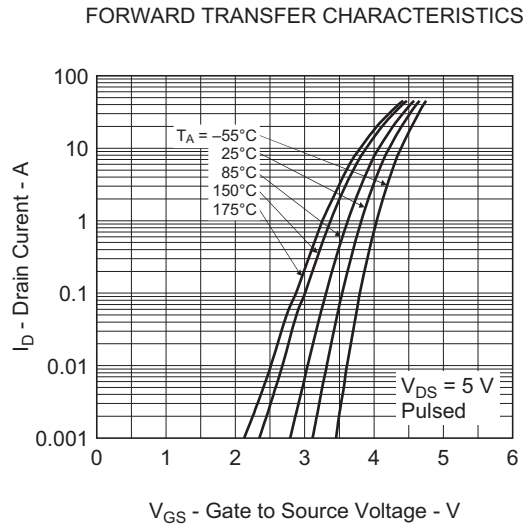
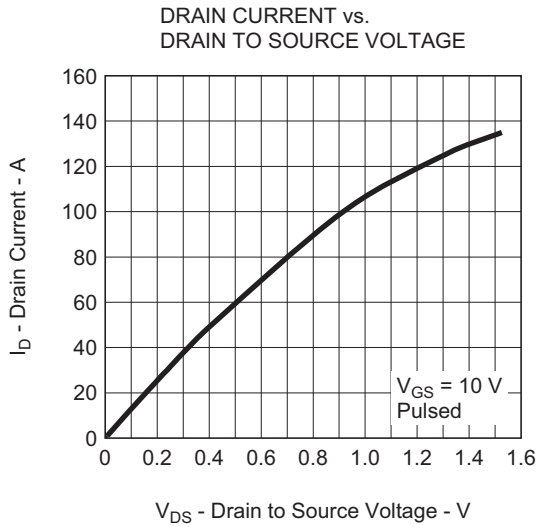

DRAIN TO SOURCE ON-STATE RESISTANCE vs. CHANNEL TEMPERATURE

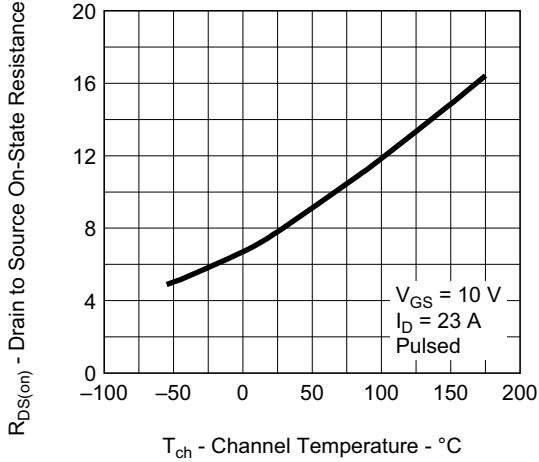

CAPACITANCE vs. DRAIN TO SOURCE VOLTAGE

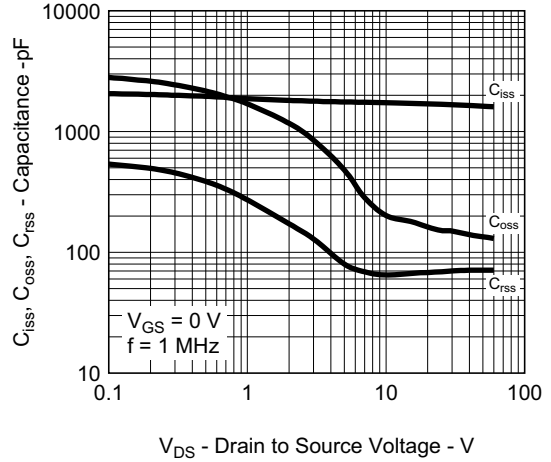

SWITCHING CHARACTERISTICS

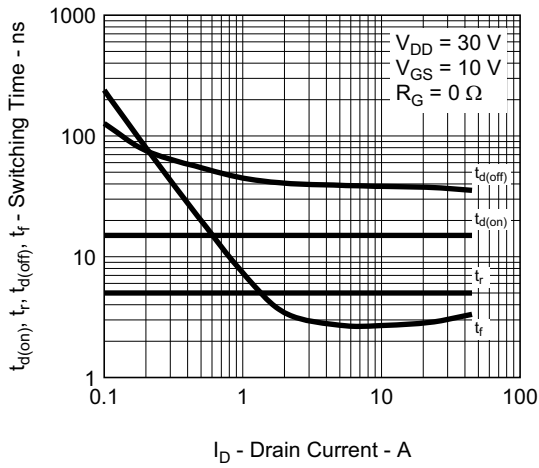

DYNAMIC INPUT/OUTPUT CHARACTERISTICS

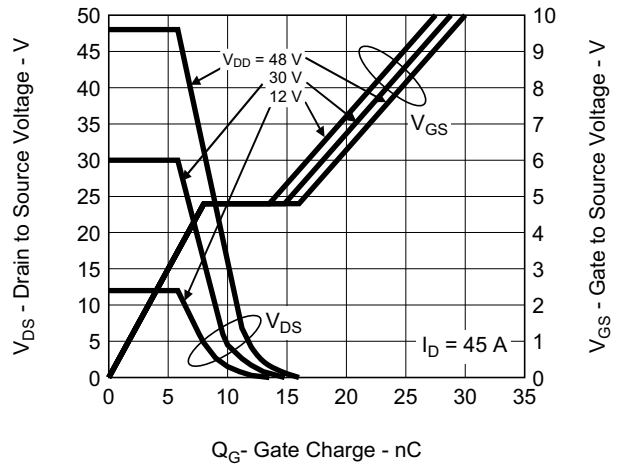

SOURCE TO DRAIN DIODE FORWARD VOLTAGE

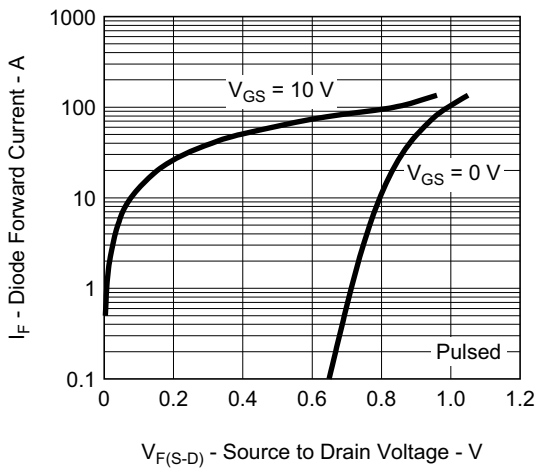

REVERSE RECOVERY TIME vs. DRAIN CURRENT

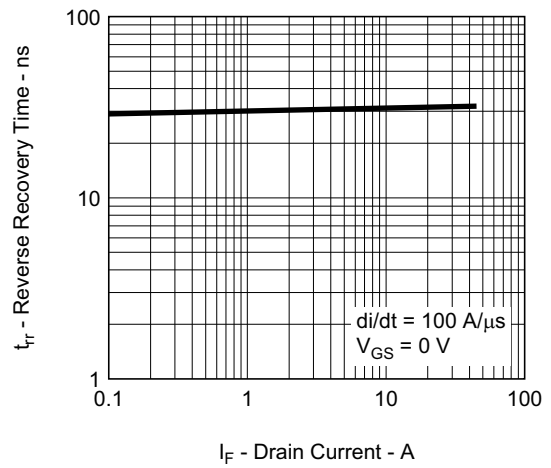

Package Drawing (Unit: mm)

TO-252 (MP-3ZP) (Mass: 0.3 g TYP.)

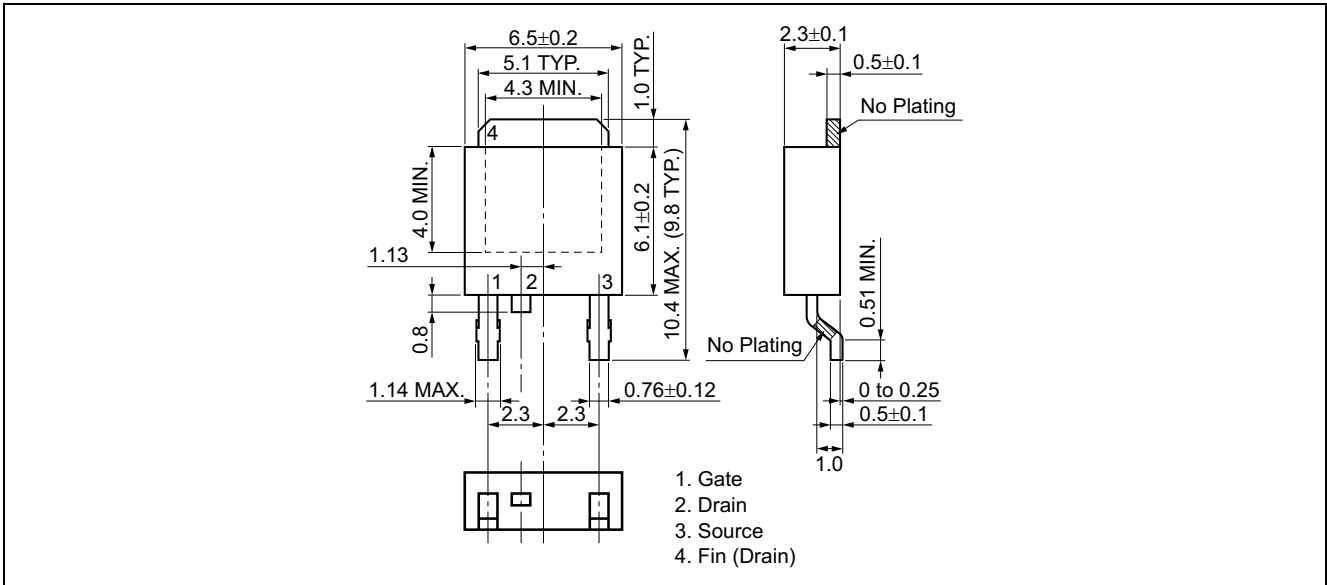

TO-263 (MP-25ZP) (Mass: 1.48 g TYP.)

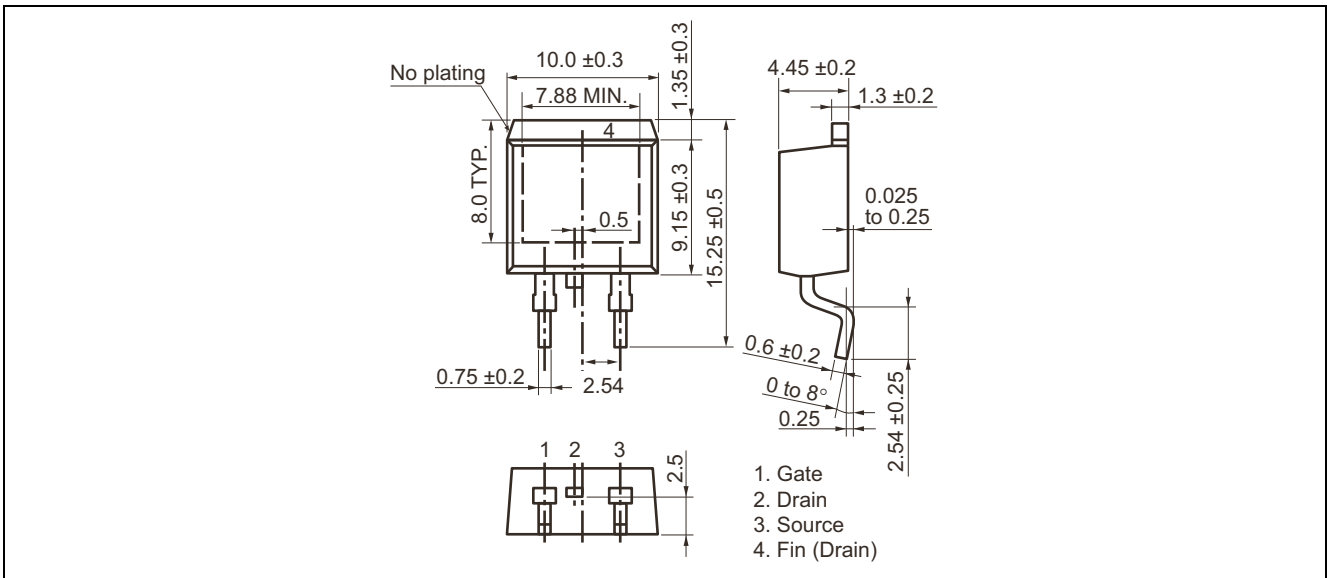

Equivalent Circuit

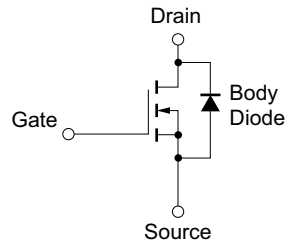

Remark: Strong electric field, when exposed to this device, can cause destruction of the gate oxide and ultimately degrade the device operation. Steps must be taken to stop generation of static electricity as much as possible, and quickly dissipate it once, when it has occurred.

Revision History	NP45N06VUK, NP45N06PUK Data Sheet
-------------------------	--

Rev.	Date	Description	
		Page	Summary
1.00	Nov 20, 2012	—	First Edition Issued
2.00	May 24 ,2018	1	Note 3 was added
		2	Note 2 was added

All trademarks and registered trademarks are the property of their respective owners.

Notice

1. Descriptions of circuits, software and other related information in this document are provided only to illustrate the operation of semiconductor products and application examples. You are fully responsible for the incorporation or any other use of the circuits, software, and information in the design of your product or system. Renesas Electronics disclaims any and all liability for any losses and damages incurred by you or third parties arising from the use of these circuits, software, or information.
2. Renesas Electronics hereby expressly disclaims any warranties against liability for infringement or any other claims involving patents, copyrights, or other intellectual property rights of third parties, by or arising from the use of Renesas Electronics products or technical information described in this document, including but not limited to, the product data, drawings, charts, programs, algorithms, and application examples.
3. No license, express, implied or otherwise, is granted hereby under any patents, copyrights or other intellectual property rights of Renesas Electronics or others.
4. You shall not alter, modify, copy, or reverse engineer any Renesas Electronics product, whether in whole or in part. Renesas Electronics disclaims any and all liability for any losses or damages incurred by you or third parties arising from such alteration, modification, copying or reverse engineering.
5. Renesas Electronics products are classified according to the following two quality grades: "Standard" and "High Quality". The intended applications for each Renesas Electronics product depends on the product's quality grade, as indicated below.
"Standard": Computers; office equipment; communications equipment; test and measurement equipment; audio and visual equipment; home electronic appliances; machine tools; personal electronic equipment; industrial robots; etc.
"High Quality": Transportation equipment (automobiles, trains, ships, etc.); traffic control (traffic lights); large-scale communication equipment; key financial terminal systems; safety control equipment; etc.
Unless expressly designated as a high reliability product or a product for harsh environments in a Renesas Electronics data sheet or other Renesas Electronics document, Renesas Electronics products are not intended or authorized for use in products or systems that may pose a direct threat to human life or bodily injury (artificial life support devices or systems; surgical implantations; etc.), or may cause serious property damage (space system; undersea repeaters; nuclear power control systems; aircraft control systems; key plant systems; military equipment; etc.). Renesas Electronics disclaims any and all liability for any damages or losses incurred by you or any third parties arising from the use of any Renesas Electronics product that is inconsistent with any Renesas Electronics data sheet, user's manual or other Renesas Electronics document.
6. When using Renesas Electronics products, refer to the latest product information (data sheets, user's manuals, application notes, "General Notes for Handling and Using Semiconductor Devices" in the reliability handbook, etc.), and ensure that usage conditions are within the ranges specified by Renesas Electronics with respect to maximum ratings, operating power supply voltage range, heat dissipation characteristics, installation, etc. Renesas Electronics disclaims any and all liability for any malfunctions, failure or accident arising out of the use of Renesas Electronics products outside of such specified ranges.
7. Although Renesas Electronics endeavors to improve the quality and reliability of Renesas Electronics products, semiconductor products have specific characteristics, such as the occurrence of failure at a certain rate and malfunctions under certain use conditions. Unless designated as a high reliability product or a product for harsh environments in a Renesas Electronics data sheet or other Renesas Electronics document, Renesas Electronics products are not subject to radiation resistance design. You are responsible for implementing safety measures to guard against the possibility of bodily injury, injury or damage caused by fire, and/or danger to the public in the event of a failure or malfunction of Renesas Electronics products, such as safety design for hardware and software, including but not limited to redundancy, fire control and malfunction prevention, appropriate treatment for aging degradation or any other appropriate measures. Because the evaluation of microcomputer software alone is very difficult and impractical, you are responsible for evaluating the safety of the final products or systems manufactured by you.
8. Please contact a Renesas Electronics sales office for details as to environmental matters such as the environmental compatibility of each Renesas Electronics product. You are responsible for carefully and sufficiently investigating applicable laws and regulations that regulate the inclusion or use of controlled substances, including without limitation, the EU RoHS Directive, and using Renesas Electronics products in compliance with all these applicable laws and regulations. Renesas Electronics disclaims any and all liability for damages or losses occurring as a result of your noncompliance with applicable laws and regulations.
9. Renesas Electronics products and technologies shall not be used for or incorporated into any products or systems whose manufacture, use, or sale is prohibited under any applicable domestic or foreign laws or regulations. You shall comply with any applicable export control laws and regulations promulgated and administered by the governments of any countries asserting jurisdiction over the parties or transactions.
10. It is the responsibility of the buyer or distributor of Renesas Electronics products, or any other party who distributes, disposes of, or otherwise sells or transfers the product to a third party, to notify such third party in advance of the contents and conditions set forth in this document.
11. This document shall not be reprinted, reproduced or duplicated in any form, in whole or in part, without prior written consent of Renesas Electronics.
12. Please contact a Renesas Electronics sales office if you have any questions regarding the information contained in this document or Renesas Electronics products.
(Note 1) "Renesas Electronics" as used in this document means Renesas Electronics Corporation and also includes its directly or indirectly controlled subsidiaries.
(Note 2) "Renesas Electronics product(s)" means any product developed or manufactured by or for Renesas Electronics.

(Rev.4.0-1 November 2017)



SALES OFFICES

Renesas Electronics Corporation

<http://www.renesas.com>

Refer to "<http://www.renesas.com/>" for the latest and detailed information.

Renesas Electronics America Inc.

1001 Murphy Ranch Road, Milpitas, CA 95035, U.S.A.
Tel: +1-408-432-8888, Fax: +1-408-434-5351

Renesas Electronics Canada Limited

9251 Yonge Street, Suite 8309 Richmond Hill, Ontario Canada L4C 9T3
Tel: +1-905-237-2004

Renesas Electronics Europe Limited

Dukes Meadow, Millboard Road, Bourne End, Buckinghamshire, SL8 5FH, U.K
Tel: +44-1628-651-700, Fax: +44-1628-651-804

Renesas Electronics Europe GmbH

Arcadiastrasse 10, 40472 Düsseldorf, Germany
Tel: +49-211-6503-0, Fax: +49-211-6503-1327

Renesas Electronics (China) Co., Ltd.

Room 1709 Quantum Plaza, No.27 ZhichunLu, Haidian District, Beijing, 100191 P. R. China
Tel: +86-10-8235-1155, Fax: +86-10-8235-7679

Renesas Electronics (Shanghai) Co., Ltd.

Unit 301, Tower A, Central Towers, 555 Langao Road, Putuo District, Shanghai, 200333 P. R. China
Tel: +86-21-2226-0888, Fax: +86-21-2226-0999

Renesas Electronics Hong Kong Limited

Unit 1601-1611, 16/F., Tower 2, Grand Century Place, 193 Prince Edward Road West, Mongkok, Kowloon, Hong Kong
Tel: +852-2265-6688, Fax: +852 2886-9022

Renesas Electronics Taiwan Co., Ltd.

13F, No. 363, Fu Shing North Road, Taipei 10543, Taiwan
Tel: +886-2-8175-9600, Fax: +886 2-8175-9670

Renesas Electronics Singapore Pte. Ltd.

80 Bendemeer Road, Unit #06-02 Hyflux Innovation Centre, Singapore 339949
Tel: +65-6213-0200, Fax: +65-6213-0300

Renesas Electronics Malaysia Sdn.Bhd.

Unit 1207, Block B, Menara Amcorp, Amcorp Trade Centre, No. 18, Jln Persiaran Barat, 46050 Petaling Jaya, Selangor Darul Ehsan, Malaysia
Tel: +60-3-7955-9390, Fax: +60-3-7955-9510

Renesas Electronics India Pvt. Ltd.

No.777C, 100 Feet Road, HAL 2nd Stage, Indiranagar, Bangalore 560 038, India
Tel: +91-80-67208700, Fax: +91-80-67208777

Renesas Electronics Korea Co., Ltd.

17F, KAMCO Yangjae Tower, 262, Gangnam-daero, Gangnam-gu, Seoul, 06265 Korea
Tel: +82-2-558-3737, Fax: +82-2-558-5338