

## Press Fit Stud Mount SCR ½", 25 Amps

**Features**

- Improved glass passivation for high reliability
- Exceptional stability at high temperatures
- Metric thread type available
- Low thermal resistance

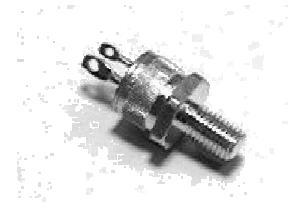

TO-48/F

Electrical Characteristics ( $T_A = 25^\circ\text{C}$ unless otherwise specified)			
Parameter	Symbol	Part Numbers	Units
Maximum repetitive peak reverse voltage, $V_{RRM}$	50	NPSS250	V
	100	NPSS251	
	200	NPSS252	
	400	NPSS254	
	600	NPSS256	
Maximum average forward output current	$I_{T(AV)}$	25	A
Peak forward surge current, single half sine-wave	$I_{TSM}$	250	A
Peak gate trigger current	$I_{GTM}$	2	A
Peak gate power dissipation @ $I_{GT} \leq I_{GTM}$	$P_{GM}$	20	W
Average gate power dissipation	$P_{G(AV)}$	0.5	W
Peak off-state current	$I_{DRM}$ & $I_{RRM}$	1.0	mA
Maximum instantaneous forward voltage drop @ 100 A	$V_{TM}$	1.5	V
DC holding current	$I_H$	50	mA
Critical rate-of-rise of off-state voltage	dv/dt	200	V/ $\mu\text{sec}$
Gate trigger current	$I_{GT}$	25	mA
Gate trigger voltage	$V_{GT}$	2.0	V
Turn-on time	Tgt	2.5	$\mu\text{sec}$

Thermal and Mechanical Specifications ( $T_A = 25^\circ\text{C}$ , unless otherwise noted)			
Parameters	Symbol	Values	Units
Maximum operating junction temperature range	$T_J$	- 40 to +110	$^\circ\text{C}$
Maximum storage temperature range	$T_{Stg}$	- 40 to +150	$^\circ\text{C}$
Maximum thermal resistance, junction to case	$R_{\theta(j-c)}$	1.8	$^\circ\text{C}/\text{W}$
Approximate weight	W	20	g

**Package Outline**

*(All dimensions in mm)*

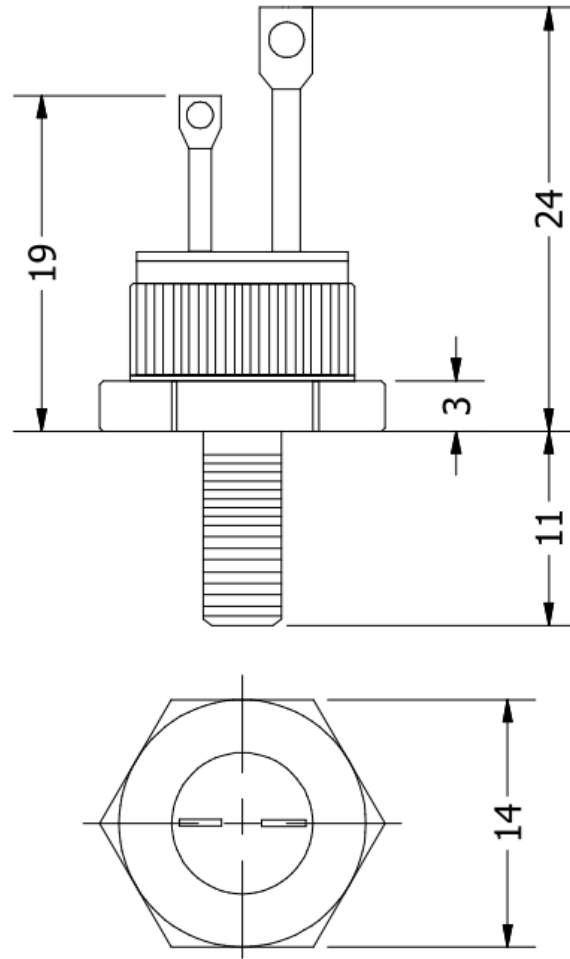

**Ordering Table**

<i>NPSS</i>	<i>25</i>	<i>0,1,2,4,6</i>
<b>1</b>	<b>2</b>	<b>3</b>

- 1 – Press Fit Stud Mount SCR
- 2 – Current,  $I_{F(AV)}$
- 3 – Voltage,  $V_{RRM}$  (See table)