

## Press Fit Triac ½", 40 Amps

**Features**

- Improved glass passivation for high reliability
- Exceptional stability at high temperatures
- Metric thread type available
- Low thermal resistance



TO-203/F

Electrical Characteristics ( $T_A = 25^\circ\text{C}$ unless otherwise specified)				
Parameter	Symbol	Part Numbers	Units	
Maximum repetitive peak reverse voltage (1), $V_{RRM}$	200	NPT402	V	
	400	NPT404		
	600	NPT406		
RMS on-state current	$I_{T(RMS)}$	40	A	
Non-repetitive peak surge on-state current, one cycle	$I_{TSM}$	400	A	
Peak gate trigger current	$I_{GTM}$	12	A	
Peak gate power dissipation @ $I_{GT} \leq I_{GTM}$	$P_{GM}$	40	W	
Average gate power dissipation	$P_{G(AV)}$	0.75	W	
Peak off-state current (1)	$I_{DRM}$ & $I_{RRM}$	1.0	mA	
Maximum instantaneous forward voltage drop (1)	$V_{TM}$	2.0	V	
DC holding current (1)	$I_H$	60	mA	
Critical rate-of-rise of off-state voltage (1)	Critical dv/dt	200	V/ $\mu\text{sec}$	
Critical rate-of-rise of commutation voltage (1)	Commutating dv/dt	3	V/ $\mu\text{sec}$	
DC gate trigger current	( $T_2+$ Gate +, $T_2-$ Gate -) Quads I and III	$I_{GT}$	100	mA
	( $T_2+$ Gate -, $T_2-$ Gate +) Quads II and IV		150	
DC gate trigger voltage	$V_{GT}$	2.5	V	
Gate controlled turn-on time	Tgt	3	$\mu\text{sec}$	

Thermal and Mechanical Specifications ( $T_A = 25^\circ\text{C}$ , unless otherwise noted)			
Parameters	Symbol	Values	Units
Maximum operating junction temperature range	$T_J$	- 40 to +110	$^\circ\text{C}$
Maximum storage temperature range	$T_{stg}$	- 40 to +150	$^\circ\text{C}$
Maximum thermal resistance, junction to case	$R_{\theta(j-c)}$	1.8	$^\circ\text{C}/\text{W}$
Approximate weight	W	15	g

Notes:

(1) All values apply in either direction

## Package Outline

(All dimensions in mm)

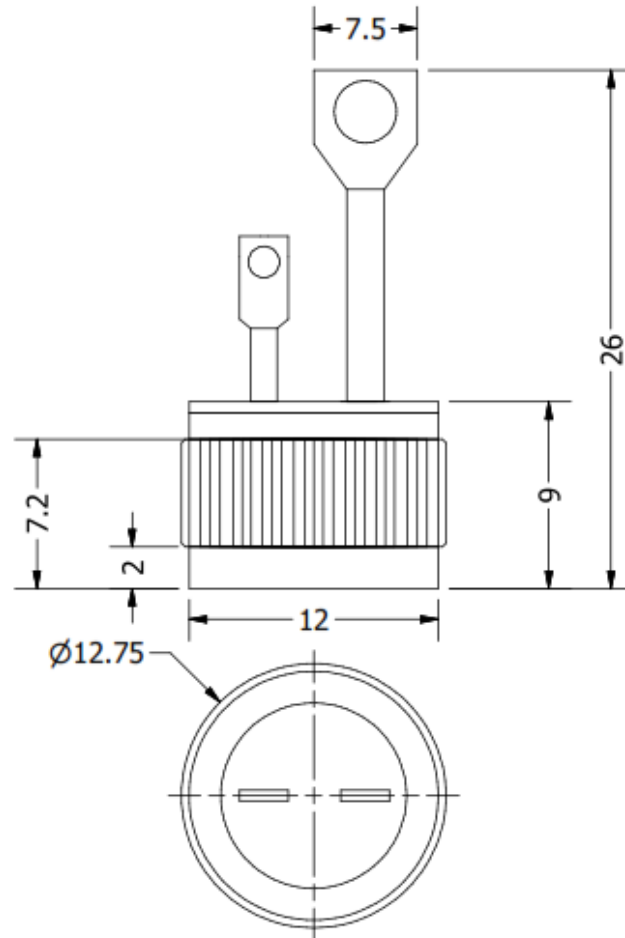

## Ordering Table

NPT	40	2,4,6
1	2	3

- 1 – Press Fit Triac
- 2 – Current,  $I_{T(RMS)}$
- 3 – Voltage,  $V_{RRM}$  (See table)