

Press Fit Stud Mount Triac ½", 25 Amps

Features

- Improved glass passivation for high reliability
- Exceptional stability at high temperatures
- Metric thread type available
- Low thermal resistance

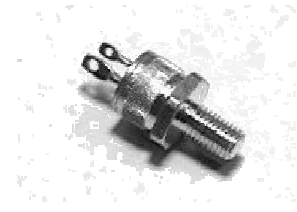

TO-48/F

Electrical Characteristics ($T_A = 25^\circ\text{C}$ unless otherwise specified)				
Parameter	Symbol	Part Numbers	Units	
Maximum repetitive peak reverse voltage (1), V_{RRM}	200	NPTS252	V	
	400	NPTS254		
	600	NPTS256		
RMS on-state current	$I_{T(RMS)}$	25	A	
Non-repetitive peak surge on-state current, one cycle	I_{TSM}	250	A	
Peak gate trigger current	I_{GTM}	4	A	
Peak gate power dissipation @ $I_{GT} \leq I_{GTM}$	P_{GM}	40	W	
Average gate power dissipation	$P_{G(AV)}$	0.8	W	
Peak off-state current (1)	I_{DRM} & I_{RRM}	1.0	mA	
Maximum instantaneous forward voltage drop (1)	V_{TM}	2.5	V	
DC holding current (1)	I_H	60	mA	
Critical rate-of-rise of off-state voltage (1)	Critical dv/dt	100	V/ μsec	
Critical rate-of-rise of commutation voltage (1)	Commutating dv/dt	3	V/ μsec	
DC gate trigger current	(T_2+ Gate +, T_2- Gate -) Quads I and III	I_{GT}	100	mA
	(T_2+ Gate -, T_2- Gate +) Quads II and IV		150	
DC gate trigger voltage	V_{GT}	2.5	V	
Gate controlled turn-on time	Tgt	3	μsec	

Thermal and Mechanical Specifications ($T_A = 25^\circ\text{C}$, unless otherwise noted)			
Parameters	Symbol	Values	Units
Maximum operating junction temperature range	T_J	- 40 to +110	$^\circ\text{C}$
Maximum storage temperature range	T_{stg}	- 40 to +150	$^\circ\text{C}$
Maximum thermal resistance, junction to case	$R_{\theta(j-c)}$	1.8	$^\circ\text{C}/\text{W}$
Approximate weight	W	20	g

Notes:

(1) All values apply in either direction

Package Outline

(All dimensions in mm)

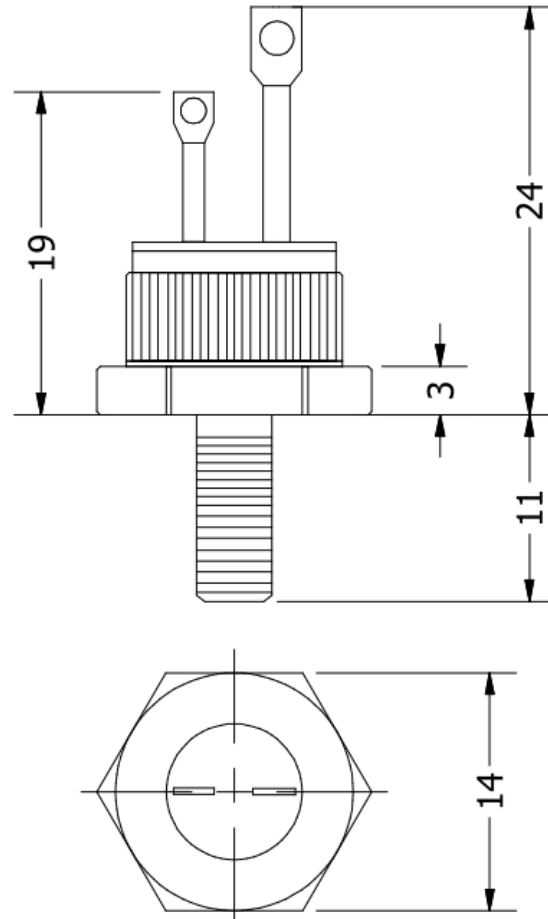

Ordering Table

NPTS	25	2,4,6
1	2	3

- 1 – Press Fit Stud Mount Triac
 2 – Current, $I_{T(RMS)}$
 3 – Voltage, V_{RRM} (See table)