

FEATURES

- **SMALL DARK CURRENT:**
 $I_D = 0.1 \text{ nA}$
- **HIGH SPEED RESPONSE:**
 $f_c = 2.5 \text{ GHz MIN.}$
- **HIGH SENSITIVITY:**
 $S = 0.89 \text{ A/W AT } \lambda = 1310 \text{ nm}$
 $S = 0.94 \text{ A/W AT } \lambda = 1550 \text{ nm}$
- **LOW OPERATING VOLTAGE:**
 $V_R = 5 \text{ V}$
- **COAXIAL MODULE WITH SINGLE MODE FIBER (SMF) or GI-50 fiber**
- **WITH SC CONNECTOR: Standard, FC connector: option**
(Refer to Ordering Information)

DESCRIPTION

NEC's NR7800 Series are InGaAs PIN photo diode (PIN-PD) coaxial modules with optical fiber pigtail. These modules are designed for long wavelength optical communication systems and are ideal as receivers for Synchronous Digital Hierarchy (SDH) system, STM-4 and STM-1, ITU-T recommendations.

ELECTRO-OPTICAL CHARACTERISTICS ($T_C = 40^\circ \text{ C to } +85^\circ \text{ C}$, unless otherwise specified)

PART NUMBER			NR7800 SERIES		
SYMBOLS	PARAMETERS AND CONDITIONS	UNITS	MIN	TYP	MAX
I_D	Dark Current, $V_R = 5 \text{ V}$, $T_C = 25^\circ \text{ C}$ $V_R = 5 \text{ V}$	nA		0.1	1.0 20
C_t	Terminal Capacitance, $V_R = 5 \text{ V}$, $f = 1 \text{ MHz}$, $T_C = 25^\circ \text{ C}$	pF		1.0	1.5
S	Sensitivity, $V_R = 5 \text{ V}$, $\lambda = 1310 \text{ nm}$ $V_R = 5 \text{ V}$, $\lambda = 1550 \text{ nm}$	A/W	0.78	0.89	
			0.80	0.94	
ΔS_t	Temperature Dependence of Sensitivity, $V_R = 5 \text{ V}$, $\lambda = 1550 \text{ nm}$	%	-5		5
ΔS_p	Polarization Dependence of Sensitivity, $V_R = 5 \text{ V}$, $\lambda = 1550 \text{ nm}$, $T_C = 25^\circ \text{ C}$	%	-2.5		2.5
ΔS_w	Wavelength Dependence of Sensitivity, $V_R = 5 \text{ V}$, $\lambda = 1520 \text{ to } 1560 \text{ nm}$, $T_C = 25^\circ \text{ C}$	%	-2.5		2.5
f_c	Cut-off Frequency, $V_R = 5 \text{ V}$, $T_C = 25^\circ \text{ C}$	GHz	2.5		
ORL	Optical Return Loss, SMF GI-50 Fiber	dB	30		
			28		

ABSOLUTE MAXIMUM RATINGS¹

(T_C = 25°C, unless otherwise specified)

SYMBOLS	PARAMETERS	UNITS	RATINGS
V _R	Reverse Voltage	V	20
I _F	Forward Current	mA	10
P _{IN}	Optical Input Power	mW	8
T _C	Operating Case Temp.	°C	-40 to +85
T _{STG}	Storage Temperature	°C	-40 to +85
T _{SLD}	Lead Soldering Temp.	°C	260 (10 sec.)
RH	Relative Humidity (noncondensing)	%	85

Note:

1. Operation in excess of any one of these parameters may result in permanent damage.

TYPICAL PERFORMANCE CURVES (T_C = 25°C, unless otherwise specified)

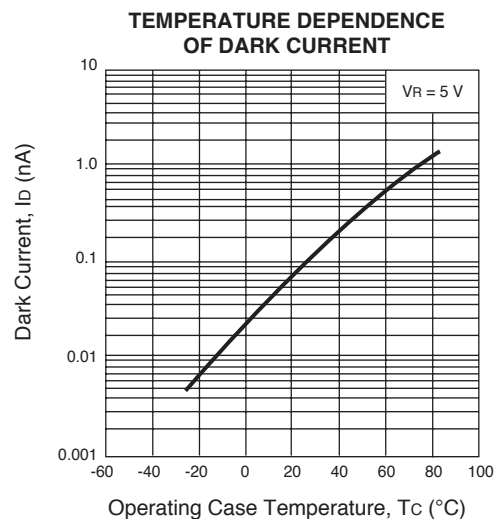
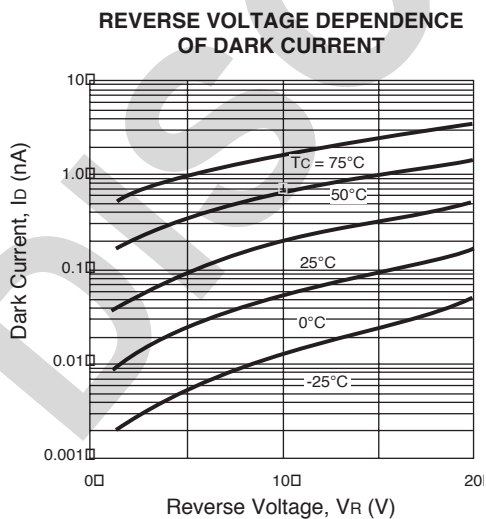
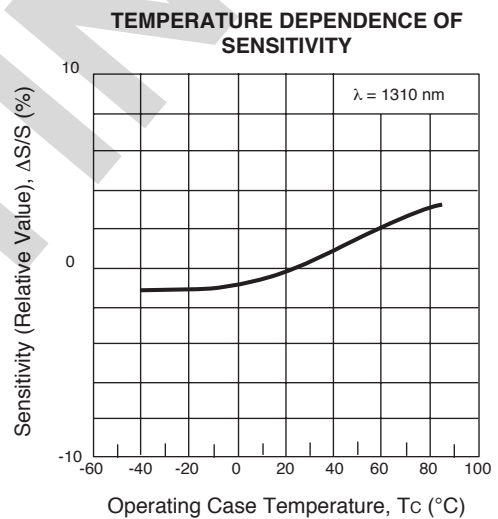
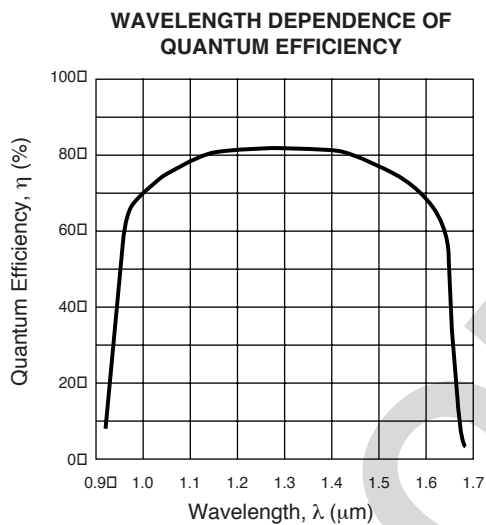

Remark: The graphs indicate nominal characteristics.

TYPICAL PERFORMANCE CURVES ($T_c = 25^\circ\text{C}$, unless otherwise specified)

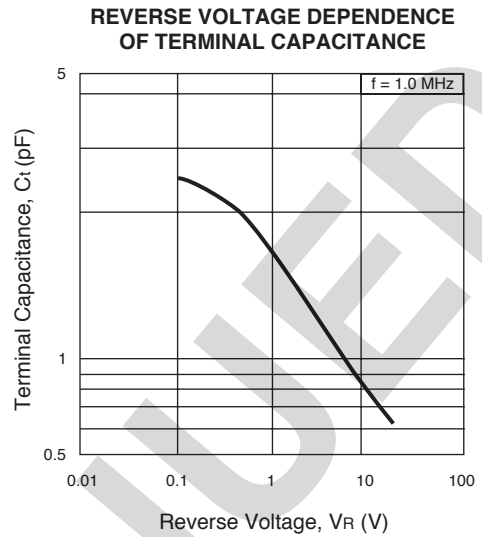
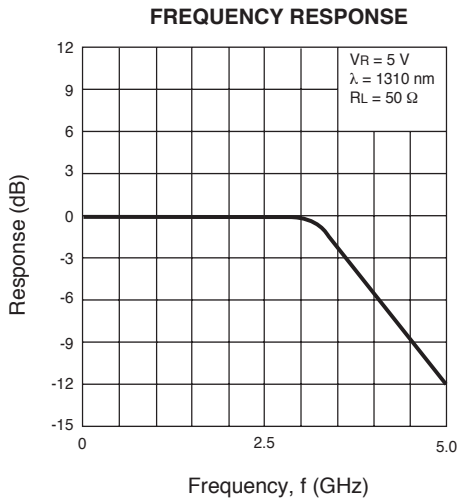

Remark: The graphs indicate nominal characteristics.

OUTLINE DIMENSIONS (Units in mm)

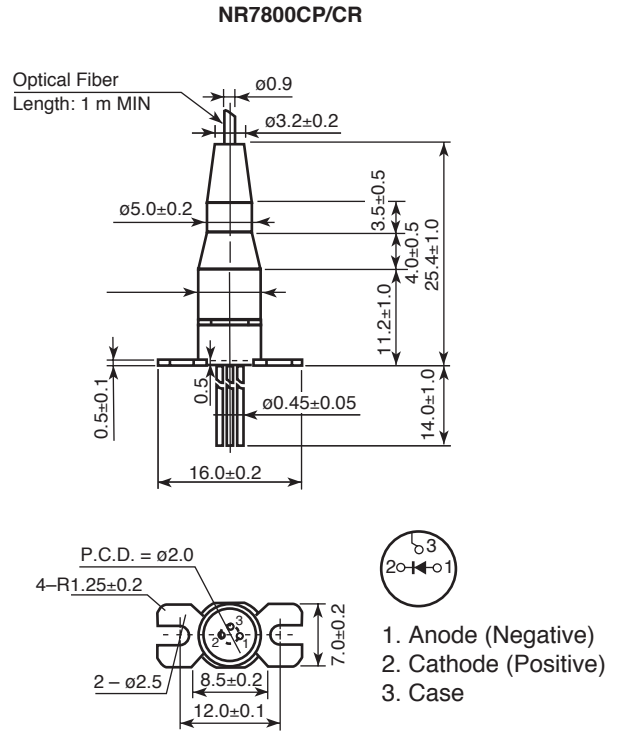
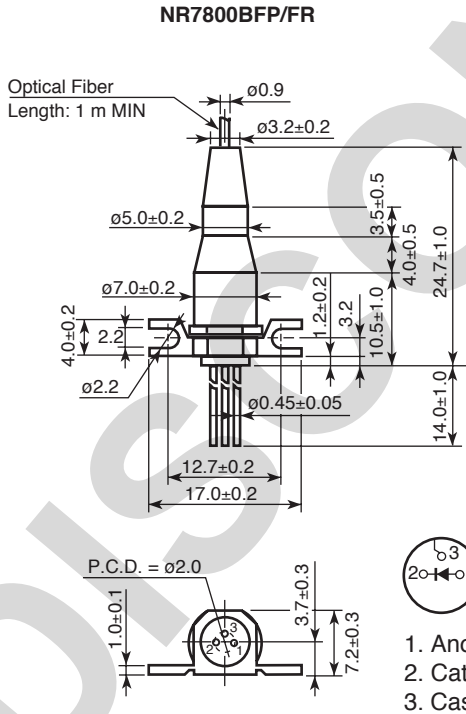

OPTICAL FIBER CHARACTERISTICS

PARAMETER	UNITS	SPECIFICATION	
		SMF	GI-50
Mode Field Diameter	μm	9.5±1	–
Core Diameter	μm	–	50±3
Cladding Diameter	μm	125±2	125±2
Maximum Cladding Noncircularity	%	2	2
Maximum Core/Cladding Concentricity	%	1.6	4.0
Outer Diameter	mm	0.9±0.1	0.9±0.1
Cut-off Wavelength	nm	1100 to 1270	–
Minimum Fiber Bending Radius	mm	30	30
Fiber Length	mm	1000 MIN	1000 MIN
Flammability		UL1581 VW-1	

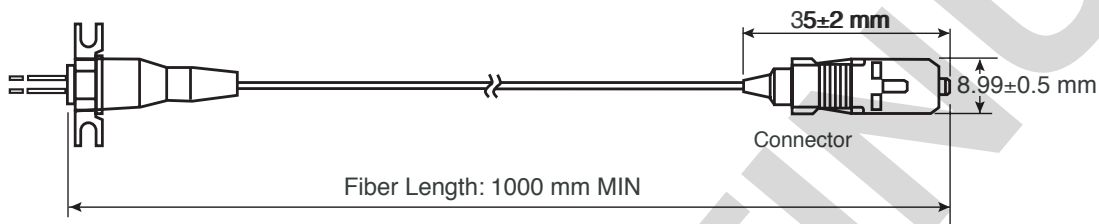

ORDERING INFORMATION

PART NUMBER	FLANGE TYPE	FIBER TYPE	AVAILABLE CONNECTOR
NR7800FP-BC-AZ*	Flat mount Flange	SMF	With FC-UPC Connector
NR7800FP-CC-AZ*			With SC-UPC Connector
NR7800FR-BB-AZ*		GI-50 Fiber	With FC-SPC Connector
NR7800FR-CB-AZ*			With SC-SPC Connector
NR7800CP-BC-AZ*	Vertical Mount Flange	SMF	With FC-UPC Connector
NR7800CP-CC-AZ*			With SC-UPC Connector
NR7800CR-BB-AZ*		GI-50 Fiber	With FC-SPC Connector
NR7800CR-CB-AZ*			With SC-SPC Connector

Note:

- 1. SC Connector: standard
FC Connector: option

***NOTE:**

Please refer to the last page of this data sheet, "Compliance with EU Directives" for Pb-Free RoHS Compliance Information.

Life Support Applications

These NEC products are not intended for use in life support devices, appliances, or systems where the malfunction of these products can reasonably be expected to result in personal injury. The customers of CEL using or selling these products for use in such applications do so at their own risk and agree to fully indemnify CEL for all damages resulting from such improper use or sale.

CEL California Eastern Laboratories, Your source for NEC RF, Microwave, Optoelectronic, and Fiber Optic Semiconductor Devices.

4590 Patrick Henry Drive • Santa Clara, CA 95054-1817 • (408) 988-3500 • FAX (408) 988-0279 • www.cel.com

DATA SUBJECT TO CHANGE WITHOUT NOTICE

04/02/2003

Subject: Compliance with EU Directives

CEL certifies, to its knowledge, that semiconductor and laser products detailed below are compliant with the requirements of European Union (EU) Directive 2002/95/EC Restriction on Use of Hazardous Substances in electrical and electronic equipment (RoHS) and the requirements of EU Directive 2003/11/EC Restriction on Penta and Octa BDE.

CEL Pb-free products have the same base part number with a suffix added. The suffix –A indicates that the device is Pb-free. The –AZ suffix is used to designate devices containing Pb which are exempted from the requirement of RoHS directive (*). In all cases the devices have Pb-free terminals. All devices with these suffixes meet the requirements of the RoHS directive.

This status is based on CEL’s understanding of the EU Directives and knowledge of the materials that go into its products as of the date of disclosure of this information.

Restricted Substance per RoHS	Concentration Limit per RoHS (values are not yet fixed)	Concentration contained in CEL devices	
		-A	-AZ
Lead (Pb)	< 1000 PPM	Not Detected	(*)
Mercury	< 1000 PPM	Not Detected	
Cadmium	< 100 PPM	Not Detected	
Hexavalent Chromium	< 1000 PPM	Not Detected	
PBB	< 1000 PPM	Not Detected	
PBDE	< 1000 PPM	Not Detected	

If you should have any additional questions regarding our devices and compliance to environmental standards, please do not hesitate to contact your local representative.

Important Information and Disclaimer: Information provided by CEL on its website or in other communications concerning the substance content of its products represents knowledge and belief as of the date that it is provided. CEL bases its knowledge and belief on information provided by third parties and makes no representation or warranty as to the accuracy of such information. Efforts are underway to better integrate information from third parties. CEL has taken and continues to take reasonable steps to provide representative and accurate information but may not have conducted destructive testing or chemical analysis on incoming materials and chemicals. CEL and CEL suppliers consider certain information to be proprietary, and thus CAS numbers and other limited information may not be available for release.

In no event shall CEL’s liability arising out of such information exceed the total purchase price of the CEL part(s) at issue sold by CEL to customer on an annual basis.

See CEL Terms and Conditions for additional clarification of warranties and liability.