

NRVBD1035CTL

Switch-mode Schottky Power Rectifier

DPAK Power Surface Mount Package

The NRVBD1035CTL employs the Schottky Barrier principle in a large area metal-to-silicon power diode. State of the art geometry features epitaxial construction with oxide passivation and metal overlay contact. Ideally suited for low voltage, high frequency switching power supplies, free wheeling diode and polarity protection diodes.

Features

- Highly Stable Oxide Passivated Junction
- Guardring for Stress Protection
- Matched Dual Die Construction –
May be Paralleled for High Current Output
- High dv/dt Capability
- Short Heat Sink Tap Manufactured – Not Sheared
- Very Low Forward Voltage Drop
- Epoxy Meets UL 94 V-0 @ 0.125 in
- This is a Pb-Free Device

Mechanical Characteristics:

- Case: Epoxy, Molded
- Weight: 0.4 Gram (Approximately)
- Finish: All External Surfaces Corrosion Resistant and Terminal Leads are Readily Solderable
- Lead and Mounting Surface Temperature for Soldering Purposes: 260°C Max. for 10 Seconds



ON Semiconductor®

www.onsemi.com

SCHOTTKY BARRIER RECTIFIER 10 AMPERES 35 VOLTS

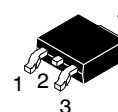
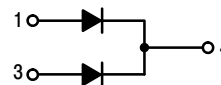

DPAK
CASE 369C

MARKING DIAGRAM

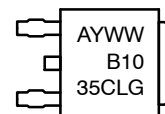

A = Assembly Location
Y = Year
WW = Work Week
B1035CL = Device Code
G = Pb-Free Package

ORDERING INFORMATION

See detailed ordering and shipping information in the package dimensions section on page 2 of this data sheet.

NRVBD1035CTL

MAXIMUM RATINGS

| Rating | Symbol | Value | Unit |
|--|---------------------------------|-------------|------------------|
| Peak Repetitive Reverse Voltage Working Peak Reverse Voltage DC Blocking Voltage | V_{RRM} V_{RWM} V_R | 35 | V |
| Average Rectified Forward Current (At Rated V_R , $T_C = 115^\circ\text{C}$) | Per Leg Per Package | 5.0 10 | A |
| Peak Repetitive Forward Current (At Rated V_R , Square Wave, 20 kHz, $T_C = 115^\circ\text{C}$) | Per Leg | 10 | A |
| Non-Repetitive Peak Surge Current (Surge applied at rated load conditions, halfwave, single phase, 60 Hz) | Per Package | 50 | A |
| Storage / Operating Case Temperature | T_{stg}, T_c | -55 to +150 | $^\circ\text{C}$ |
| Operating Junction Temperature (Note 1) | T_J | -55 to +150 | $^\circ\text{C}$ |
| Voltage Rate of Change (Rated V_R , $T_J = 25^\circ\text{C}$) | dv/dt | 10,000 | V/ μs |

Stresses exceeding those listed in the Maximum Ratings table may damage the device. If any of these limits are exceeded, device functionality should not be assumed, damage may occur and reliability may be affected.

1. The heat generated must be less than the thermal conductivity from Junction-to-Ambient: $dP_D/dT_J < 1/R_{\theta JA}$.

THERMAL CHARACTERISTICS

| | | | | |
|--|---------|-----------------|-----|--------------------|
| Thermal Resistance, Junction-to-Case | Per Leg | $R_{\theta JC}$ | 3.0 | $^\circ\text{C/W}$ |
| Thermal Resistance, Junction-to-Ambient (Note 2) | Per Leg | $R_{\theta JA}$ | 137 | $^\circ\text{C/W}$ |

ELECTRICAL CHARACTERISTICS

| | | | | |
|--|---------|-------|------------------------------|----|
| Maximum Instantaneous Forward Voltage (Note 3) (See Figure 2) | Per Leg | V_F | 0.47 0.41 0.56 0.55 | V |
| Maximum Instantaneous Reverse Current (Note 3) (See Figure 4) | Per Leg | I_R | 2.0 30 0.20 5.0 | mA |
| $I_F = 5$ Amps, $T_J = 25^\circ\text{C}$ | | | | |
| $I_F = 5$ Amps, $T_J = 100^\circ\text{C}$ | | | | |
| $I_F = 10$ Amps, $T_J = 25^\circ\text{C}$ | | | | |
| $I_F = 10$ Amps, $T_J = 100^\circ\text{C}$ | | | | |
| $V_R = 35$ V, $T_J = 25^\circ\text{C}$ | | | | |
| $V_R = 35$ V, $T_J = 100^\circ\text{C}$ | | | | |
| $V_R = 17.5$ V, $T_J = 25^\circ\text{C}$ | | | | |
| $V_R = 17.5$ V, $T_J = 100^\circ\text{C}$ | | | | |

2. Rating applies when using minimum pad size, FR4 PC Board

3. Pulse Test: Pulse Width $\leq 250 \mu\text{s}$, Duty Cycle $\leq 2.0\%$

ORDERING INFORMATION

| Device | Package | Shipping† |
|-----------------|-------------------|--------------------------|
| NRVBD1035CTLT4G | DPAK (Pb-Free) | 2500 Units / Tape & Reel |

†For information on tape and reel specifications, including part orientation and tape sizes, please refer to our Tape and Reel Packaging Specifications Brochure, BRD8011/D.

NRVBD1035CTL

TYPICAL CHARACTERISTICS

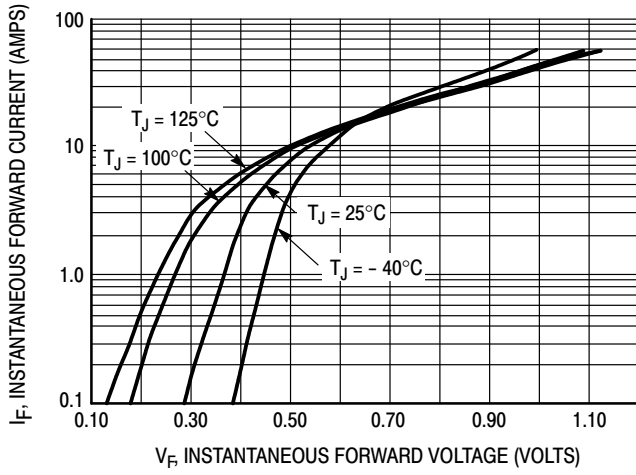

Figure 1. Typical Forward Voltage Per Leg

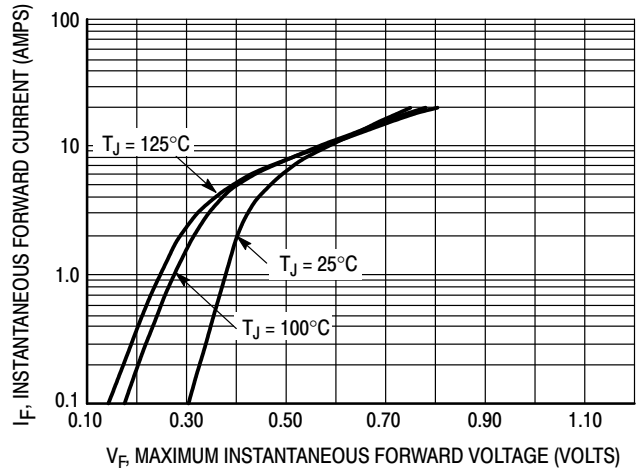

Figure 2. Maximum Forward Voltage Per Leg

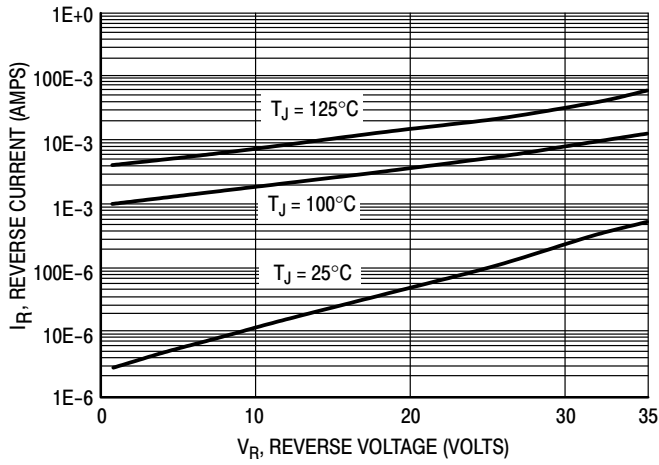

Figure 3. Typical Reverse Current Per Leg

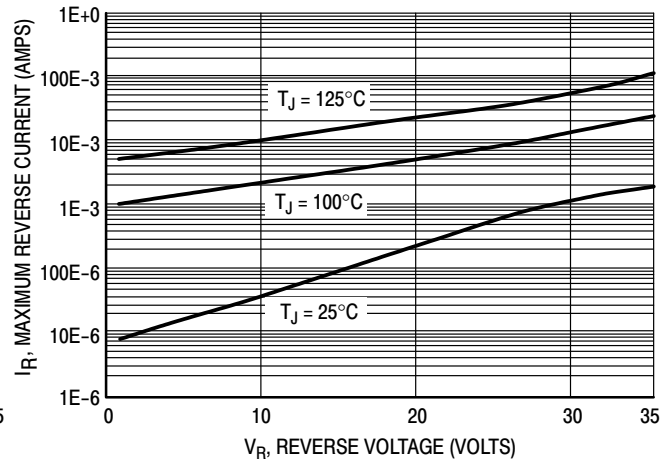

Figure 4. Maximum Reverse Current Per Leg

NRVBD1035CTL

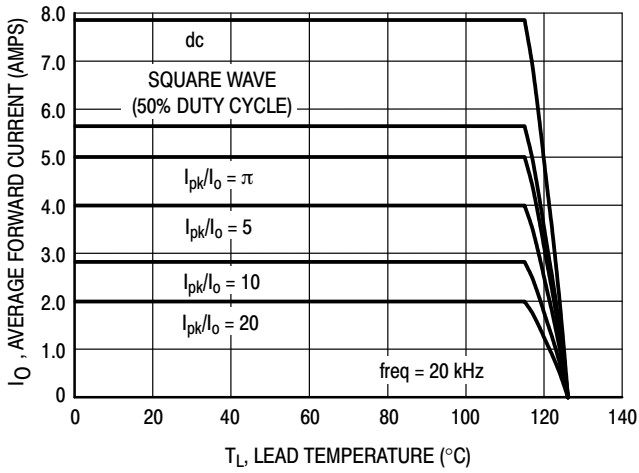

Figure 5. Current Derating Per Leg

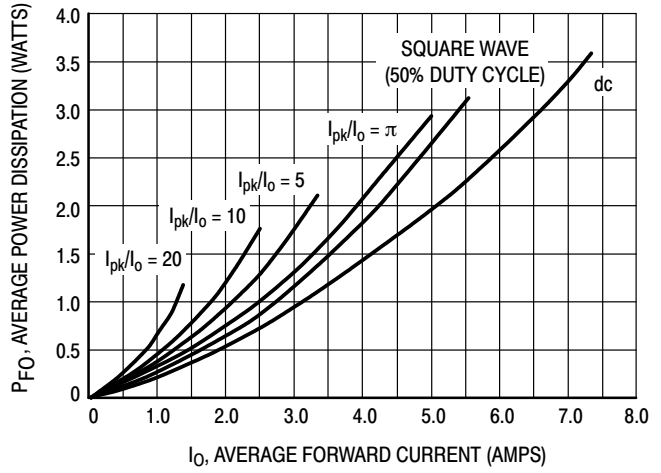

Figure 6. Forward Power Dissipation Per Leg

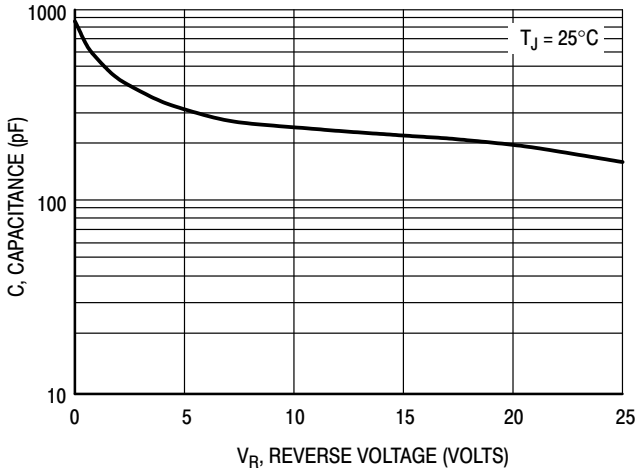

Figure 7. Capacitance Per Leg

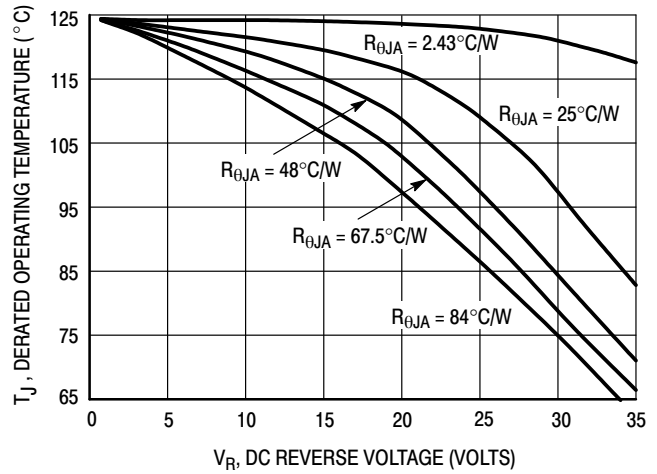

Figure 8. Typical Operating Temperature Derating Per Leg *

* Reverse power dissipation and the possibility of thermal runaway must be considered when operating this device under any reverse voltage conditions. Calculations of T_J therefore must include forward and reverse power effects. The allowable operating T_J may be calculated from the equation:

$$T_J = T_{Jmax} - r(t)(P_f + P_r) \text{ where}$$

$r(t)$ = thermal impedance under given conditions,
 P_f = forward power dissipation, and
 P_r = reverse power dissipation

This graph displays the derated allowable T_J due to reverse bias under DC conditions only and is calculated as $T_J = T_{Jmax} - r(t)P_r$, where $r(t) = R_{thja}$. For other power applications further calculations must be performed.

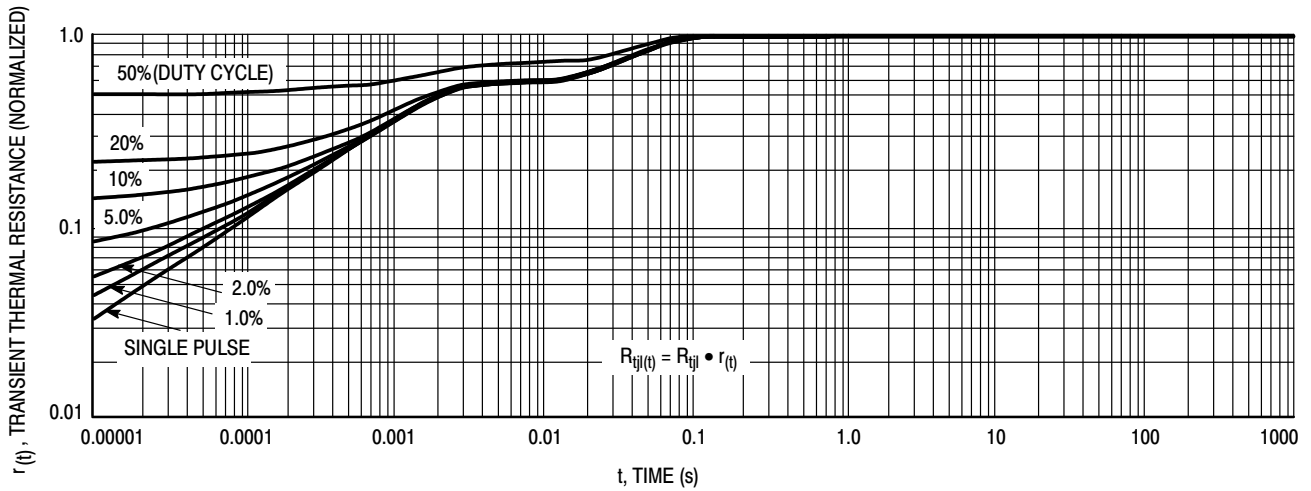

Figure 9. Thermal Response Junction to Case (Per Leg)

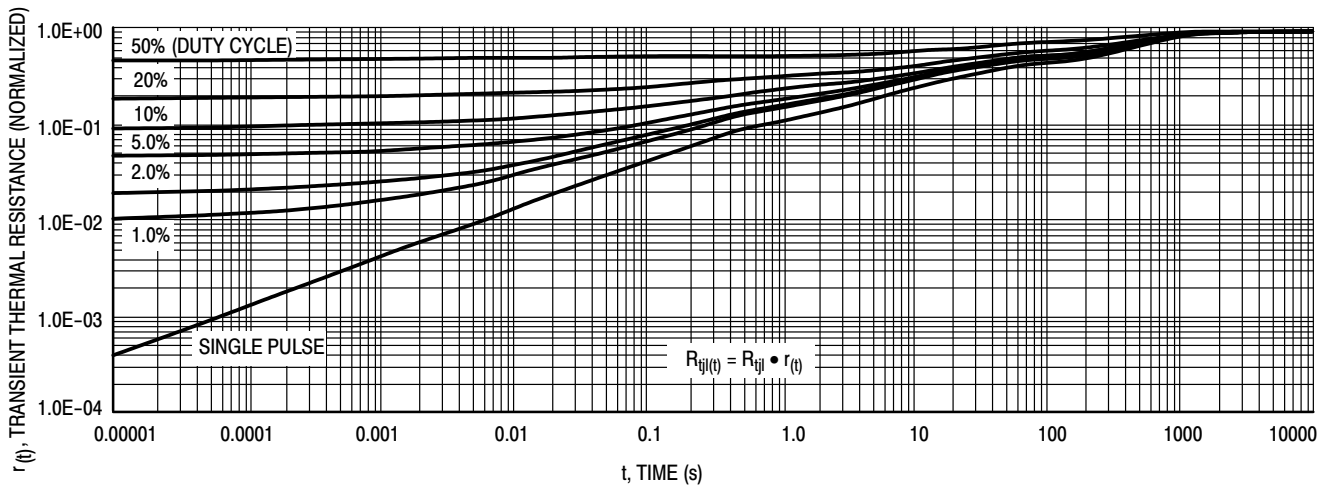
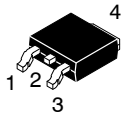

Figure 10. Thermal Response Junction to Ambient (Per Leg)

MECHANICAL CASE OUTLINE PACKAGE DIMENSIONS



DPAK (SINGLE GAUGE) CASE 369C ISSUE F

DATE 21 JUL 2015

SCALE 1:1



NOTES:

1. DIMENSIONING AND TOLERANCING PER ASME Y14.5M, 1994.
2. CONTROLLING DIMENSION: INCHES.
3. THERMAL PAD CONTOUR OPTIONAL WITHIN DIMENSIONS b3, L3 and Z.
4. DIMENSIONS D AND E DO NOT INCLUDE MOLD FLASH, PROTRUSIONS, OR BURRS. MOLD FLASH, PROTRUSIONS, OR GATE BURRS SHALL NOT EXCEED 0.006 INCHES PER SIDE.
5. DIMENSIONS D AND E ARE DETERMINED AT THE OUTERMOST EXTREMES OF THE PLASTIC BODY.
6. DATUMS A AND B ARE DETERMINED AT DATUM PLANE H.
7. OPTIONAL MOLD FEATURE.

| DIM | INCHES | | MILLIMETERS | |
|-----|--------|-------|-------------|-------|
| | MIN | MAX | MIN | MAX |
| A | 0.086 | 0.094 | 2.18 | 2.38 |
| A1 | 0.000 | 0.005 | 0.00 | 0.13 |
| b | 0.025 | 0.035 | 0.63 | 0.89 |
| b2 | 0.028 | 0.045 | 0.72 | 1.14 |
| b3 | 0.180 | 0.215 | 4.57 | 5.46 |
| c | 0.018 | 0.024 | 0.46 | 0.61 |
| c2 | 0.018 | 0.024 | 0.46 | 0.61 |
| D | 0.235 | 0.245 | 5.97 | 6.22 |
| E | 0.250 | 0.265 | 6.35 | 6.73 |
| e | 0.090 | BSC | 2.29 | BSC |
| H | 0.370 | 0.410 | 9.40 | 10.41 |
| L | 0.055 | 0.070 | 1.40 | 1.78 |
| L1 | 0.114 | REF | 2.90 | REF |
| L2 | 0.020 | BSC | 0.51 | BSC |
| L3 | 0.035 | 0.050 | 0.89 | 1.27 |
| L4 | --- | 0.040 | --- | 1.01 |
| Z | 0.155 | --- | 3.93 | --- |

GENERIC MARKING DIAGRAM*

- | | | | | |
|--|--|---|---|--|
| <p>STYLE 1: PIN 1. BASE 2. COLLECTOR 3. EMITTER 4. COLLECTOR</p> | <p>STYLE 2: PIN 1. GATE 2. DRAIN 3. SOURCE 4. DRAIN</p> | <p>STYLE 3: PIN 1. ANODE 2. CATHODE 3. ANODE 4. CATHODE</p> | <p>STYLE 4: PIN 1. CATHODE 2. ANODE 3. GATE 4. ANODE</p> | <p>STYLE 5: PIN 1. GATE 2. ANODE 3. CATHODE 4. ANODE</p> |
| <p>STYLE 6: PIN 1. MT1 2. MT2 3. GATE 4. MT2</p> | <p>STYLE 7: PIN 1. GATE 2. COLLECTOR 3. EMITTER 4. COLLECTOR</p> | <p>STYLE 8: PIN 1. N/C 2. CATHODE 3. ANODE 4. CATHODE</p> | <p>STYLE 9: PIN 1. ANODE 2. CATHODE 3. RESISTOR ADJUST 4. CATHODE</p> | <p>STYLE 10: PIN 1. CATHODE 2. ANODE 3. CATHODE 4. ANODE</p> |



- XXXXXX = Device Code
- A = Assembly Location
- L = Wafer Lot
- Y = Year
- WW = Work Week
- G = Pb-Free Package

*This information is generic. Please refer to device data sheet for actual part marking. Pb-Free indicator, "G" or microdot "•", may or may not be present. Some products may not follow the Generic Marking.

SOLDERING FOOTPRINT*



SCALE 3:1 (mm/inches)

*For additional information on our Pb-Free strategy and soldering details, please download the ON Semiconductor Soldering and Mounting Techniques Reference Manual, SOLDERRM/D.

| | | |
|------------------|---------------------|--|
| DOCUMENT NUMBER: | 98AON10527D | Electronic versions are uncontrolled except when accessed directly from the Document Repository. Printed versions are uncontrolled except when stamped "CONTROLLED COPY" in red. |
| DESCRIPTION: | DPAK (SINGLE GAUGE) | PAGE 1 OF 1 |

onsemi and ONSEMI are trademarks of Semiconductor Components Industries, LLC dba onsemi or its subsidiaries in the United States and/or other countries. onsemi reserves the right to make changes without further notice to any products herein. onsemi makes no warranty, representation or guarantee regarding the suitability of its products for any particular purpose, nor does onsemi assume any liability arising out of the application or use of any product or circuit, and specifically disclaims any and all liability, including without limitation special, consequential or incidental damages. onsemi does not convey any license under its patent rights nor the rights of others.

onsemi, **Onsemi**, and other names, marks, and brands are registered and/or common law trademarks of Semiconductor Components Industries, LLC dba "**onsemi**" or its affiliates and/or subsidiaries in the United States and/or other countries. **onsemi** owns the rights to a number of patents, trademarks, copyrights, trade secrets, and other intellectual property. A listing of **onsemi**'s product/patent coverage may be accessed at www.onsemi.com/site/pdf/Patent-Marking.pdf. **onsemi** reserves the right to make changes at any time to any products or information herein, without notice. The information herein is provided "as-is" and **onsemi** makes no warranty, representation or guarantee regarding the accuracy of the information, product features, availability, functionality, or suitability of its products for any particular purpose, nor does **onsemi** assume any liability arising out of the application or use of any product or circuit, and specifically disclaims any and all liability, including without limitation special, consequential or incidental damages. Buyer is responsible for its products and applications using **onsemi** products, including compliance with all laws, regulations and safety requirements or standards, regardless of any support or applications information provided by **onsemi**. "Typical" parameters which may be provided in **onsemi** data sheets and/or specifications can and do vary in different applications and actual performance may vary over time. All operating parameters, including "Typicals" must be validated for each customer application by customer's technical experts. **onsemi** does not convey any license under any of its intellectual property rights nor the rights of others. **onsemi** products are not designed, intended, or authorized for use as a critical component in life support systems or any FDA Class 3 medical devices or medical devices with a same or similar classification in a foreign jurisdiction or any devices intended for implantation in the human body. Should Buyer purchase or use **onsemi** products for any such unintended or unauthorized application, Buyer shall indemnify and hold **onsemi** and its officers, employees, subsidiaries, affiliates, and distributors harmless against all claims, costs, damages, and expenses, and reasonable attorney fees arising out of, directly or indirectly, any claim of personal injury or death associated with such unintended or unauthorized use, even if such claim alleges that **onsemi** was negligent regarding the design or manufacture of the part. **onsemi** is an Equal Opportunity/Affirmative Action Employer. This literature is subject to all applicable copyright laws and is not for resale in any manner.

PUBLICATION ORDERING INFORMATION

LITERATURE FULFILLMENT:

Email Requests to: orderlit@onsemi.com

onsemi Website: www.onsemi.com

TECHNICAL SUPPORT

North American Technical Support:

Voice Mail: 1 800-282-9855 Toll Free USA/Canada

Phone: 011 421 33 790 2910

Europe, Middle East and Africa Technical Support:

Phone: 00421 33 790 2910

For additional information, please contact your local Sales Representative