

Switch-mode Power Rectifier

MUR550APFG, MURD550PFG, MUR550PFG, MURF550PFG, NRVUD550PFT4G, NRVUD550PFT4G-VF01

These state-of-the-art devices are designed for power factor correction in discontinuous and critical conduction mode.

Features

- 520 V Rating Meets 80% Derating Requirements of Major OEMs
- Low Forward Voltage Drop
- Low Leakage
- Ultrafast 95 Nanosecond Recovery Time
- Reduces Forward Conduction Loss
- NRVUD Prefix for Automotive and Other Applications Requiring Unique Site and Control Change Requirements; AEC-Q101 Qualified and PPAP Capable
- These Devices are Pb-Free, Halogen Free/BFR Free and are RoHS Compliant

Applications

- DCM PFC Designs
- Switching Power Supplies
- Power Inverters

Mechanical Characteristics:

- Case: Epoxy, Molded
- Epoxy Meets UL 94 V-0 @ 0.125 in
- Weight: MUR550APFG: 1.1 Gram (Approximately)
MURD550PFG, NRVUD550PFT4G,
NRVUD550PFT4G-VF01: 0.4 Gram
(Approximately)
MUR550PFG, MURF550PFG: 1.9 Gram
(Approximately)
- Finish: All External Surfaces Corrosion Resistant and Terminal Leads are Readily Solderable
- Lead and Mounting Surface Temperature for Soldering Purposes: 260°C Max. for 10 Seconds



ON Semiconductor®

www.onsemi.com

ULTRAFAST RECTIFIER 5.0 AMPERES, 520 VOLTS

MARKING DIAGRAMS

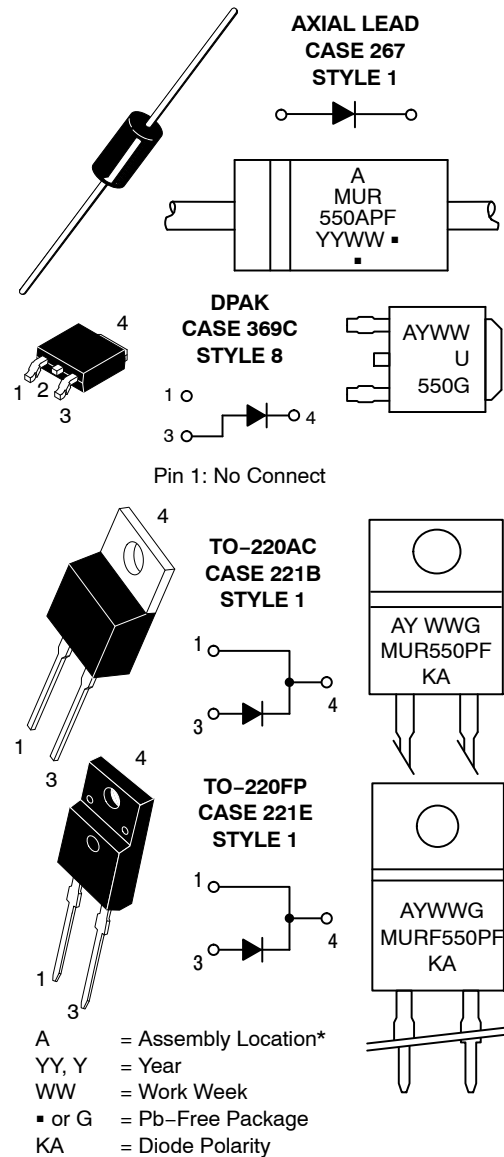

*The Assembly Location Code (A) is front side optional. In cases where the Assembly Location is stamped in the package bottom (molding ejector pin), the front side assembly code may be blank.
(Note: Microdot may be in either location)

MUR550APFG, MURD550PFG, MUR550PFG, MURF550PFG, NRVUD550PFT4G,

ORDERING INFORMATION

Device	Package	Shipping†
MUR550APFG	Axial	500 Units/Bag
MUR550APFRLG	Axial	1,500 Tape & Reel
MURD550PFT4G	DPAK (Pb-Free)	2,500 Tape & Reel
NRVUD550PFT4G*	DPAK (Pb-Free)	2,500 Tape & Reel
NRVUD550PFT4G-VF01*	DPAK (Pb-Free)	50 Units / Rail
MUR550PFG	TO-220AC (Pb-Free)	50 Units / Rail
MURF550PFG	TO-220FP (Pb-Free)	50 Units / Rail

†For information on tape and reel specifications, including part orientation and tape sizes, please refer to our Tape and Reel Packaging Specification Brochure, BRD8011/D.

*NRVUD Prefix for Automotive and Other Applications Requiring Unique Site and Control Change Requirements; AEC-Q101 Qualified and PPAP Capable.

MAXIMUM RATINGS

Rating	Symbol	Value	Unit
Peak Repetitive Reverse Voltage Working Peak Reverse Voltage DC Blocking Voltage	V_{RRM} V_{RWM} V_R	520	V
Average Rectified Forward Current (Rated V_R) $T_C = 65^\circ\text{C}$ (Rated V_R) $T_C = 160^\circ\text{C}$	$I_{F(AV)}$	5.0 5.0	A
Non-Repetitive Peak Surge Current (Surge Applied at Rated Load Conditions Halfwave, 60 Hz)	I_{FSM}	85 75 100	A
Operating Junction Temperature Range	T_J	-65 to +175	$^\circ\text{C}$
Storage Temperature Range	T_{stg}	-65 to +175	$^\circ\text{C}$
ESD Ratings: Machine Model = C Human Body Model = 3B	ESD	> 400 > 8000	V

Stresses exceeding those listed in the Maximum Ratings table may damage the device. If any of these limits are exceeded, device functionality should not be assumed, damage may occur and reliability may be affected.

THERMAL CHARACTERISTICS

Characteristic	Symbol	Value	Unit
Thermal Resistance, Junction-to-Case (Note 1) MURD550PFG, MUR550PFG, NRVUD550PFT4G, NRVUD550PFT4G-VF01 MURF550PFG	$R_{\theta JC}$	2.8 5.75	$^\circ\text{C/W}$
Thermal Resistance, Junction-to-Ambient MUR550APFG NRVUD550PFT4G, NRVUD550PFT4G-VF01, MURD550PFG (Note 3), MURF550PFG	$R_{\theta JA}$	Note 2 62 75	$^\circ\text{C/W}$

1. Rating applies when surface mounted on the minimum pad sizes recommended.
2. See Note 2, Ambient Mounting Data.
3. 1 inch square pad size on FR4 board.

MUR550APFG, MURD550PFG, MUR550PFG, MURF550PFG, NRVUD550PFT4G,

ELECTRICAL CHARACTERISTICS

Characteristic	Symbol	Value	Unit
Maximum Instantaneous Forward Voltage Drop (Note 4) ($I_F = 5.0 \text{ A}$, $T_J = 25^\circ\text{C}$) ($I_F = 5.0 \text{ A}$, $T_J = 150^\circ\text{C}$)	V_F	1.15 0.98	V
Maximum Instantaneous Reverse Current (Note 4) ($V_R = 520 \text{ V}$, $T_J = 25^\circ\text{C}$) ($V_R = 520 \text{ V}$, $T_J = 150^\circ\text{C}$)	I_R	5.0 400	μA
Maximum Reverse Recovery Time ($I_F = 1.0 \text{ A}$, $di/dt = 50 \text{ A}/\mu\text{s}$, $V_R = 30 \text{ V}$, $T_J = 25^\circ\text{C}$)	t_{rr}	95	ns

Product parametric performance is indicated in the Electrical Characteristics for the listed test conditions, unless otherwise noted. Product performance may not be indicated by the Electrical Characteristics if operated under different conditions.

4. Pulse Test: Pulse Width = 300 μs , Duty Cycle $\leq 2.0\%$.

NOTE 2 — AMBIENT MOUNTING DATA

Data shown for thermal resistance junction-to-ambient ($R_{\theta JA}$) for the mountings shown is to be used as typical guideline values for preliminary engineering or in case the tie point temperature cannot be measured.

TYPICAL VALUES FOR $R_{\theta JA}$ IN STILL AIR

Mounting Method	$R_{\theta JA}$	Lead Length, L (IN)				Units
		1/8	1/4	1/2	3/4	
1		50	51	53	55	°C/W
2		58	59	61	63	°C/W
3		28				°C/W

MOUNTING METHOD 1

P.C. Board Where Available Copper Surface area is small.

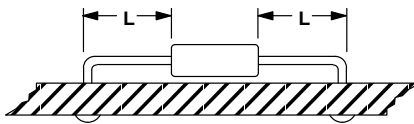

MOUNTING METHOD 2

Vector Push-In Terminals T-28

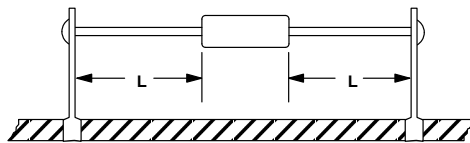

MOUNTING METHOD 3

P.C. Board with 1-1/2" x 1-1/2" Copper Surface

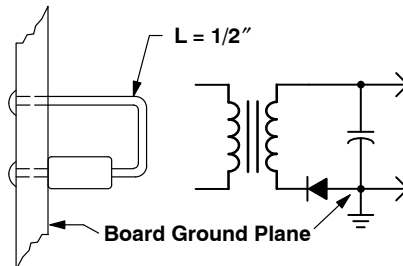

MUR550APFG, MURD550PFG, MUR550PFG, MURF550PFG, NRVUD550PFT4G,

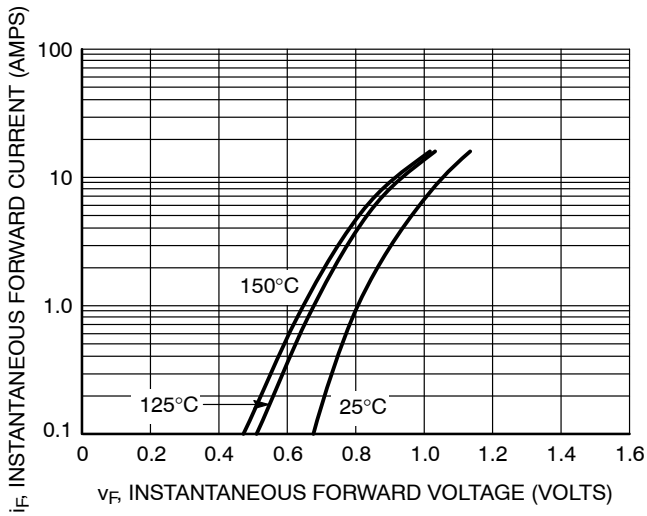

Figure 1. Typical Forward Voltage

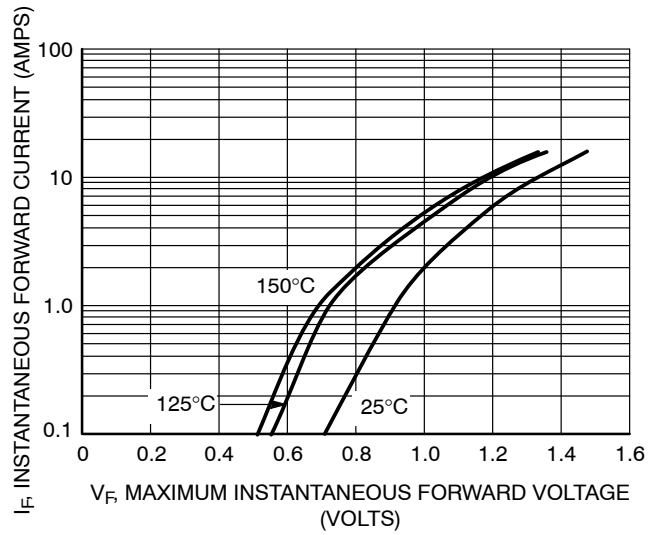

Figure 2. Maximum Forward Voltage

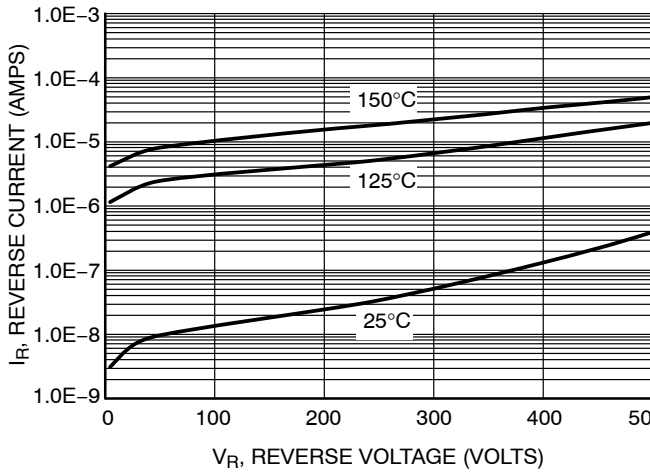

Figure 3. Typical Reverse Current

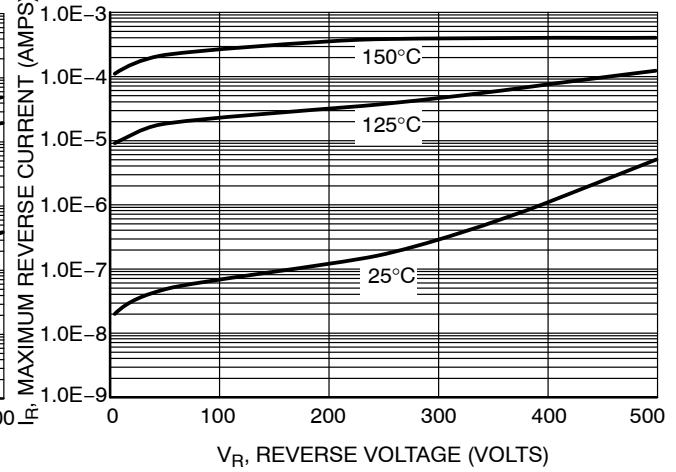

Figure 4. Maximum Reverse Current

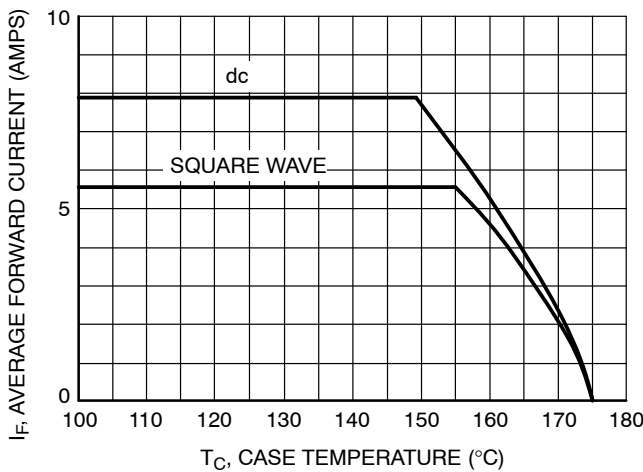

Figure 5. Current Derating

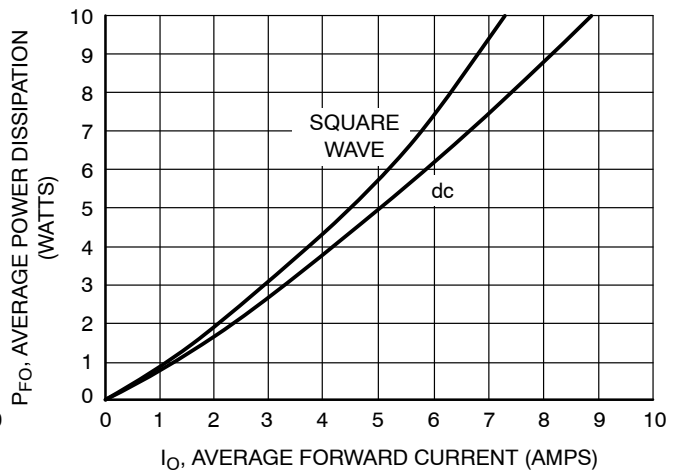

Figure 6. Forward Power Dissipation

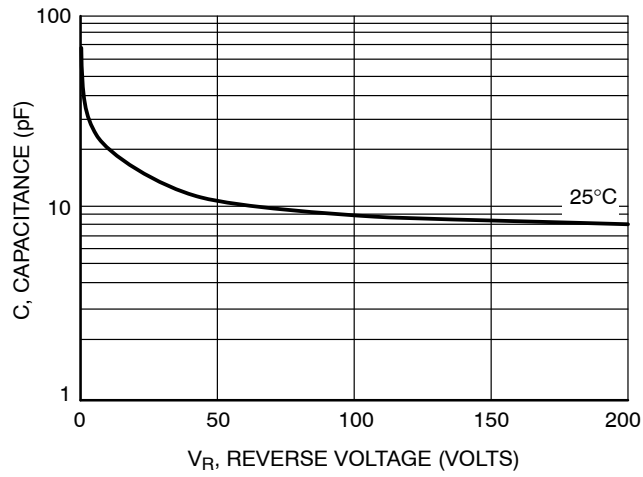

Figure 7. Capacitance

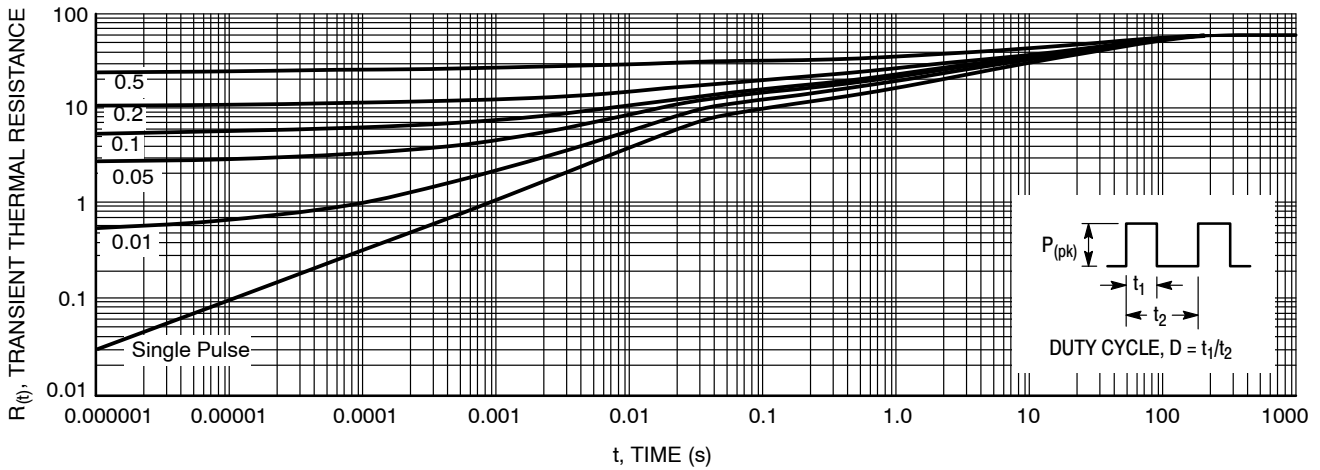

Figure 8. Thermal Response for MUR550APFG

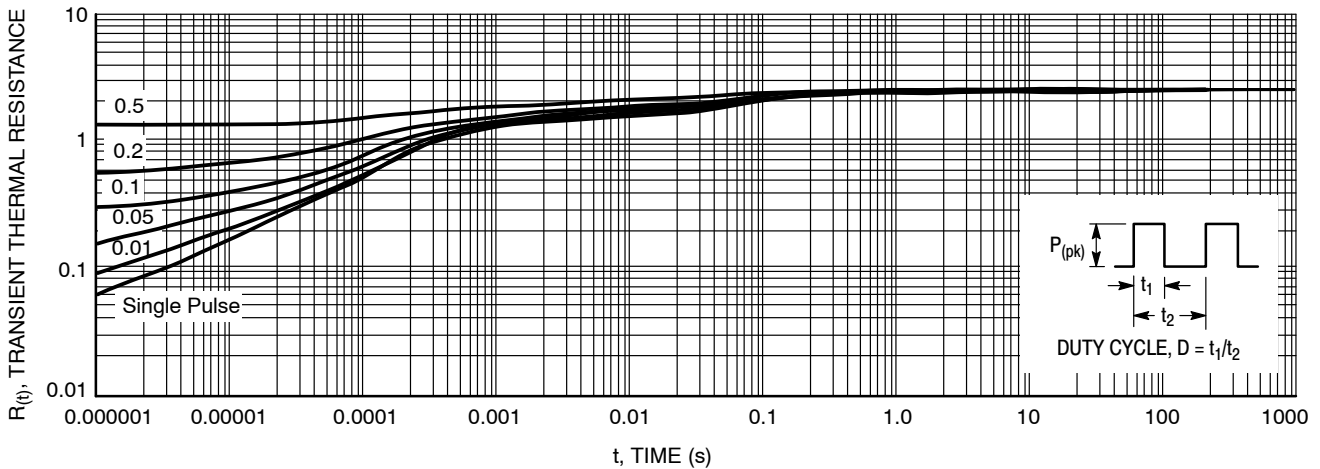

Figure 9. Thermal Response for MURD550PFG, NRVUD550PFT4G, NRVUD550PFT4G-VF01

MUR550APFG, MURD550PFG, MUR550PFG, MURF550PFG, NRVUD550PFT4G,

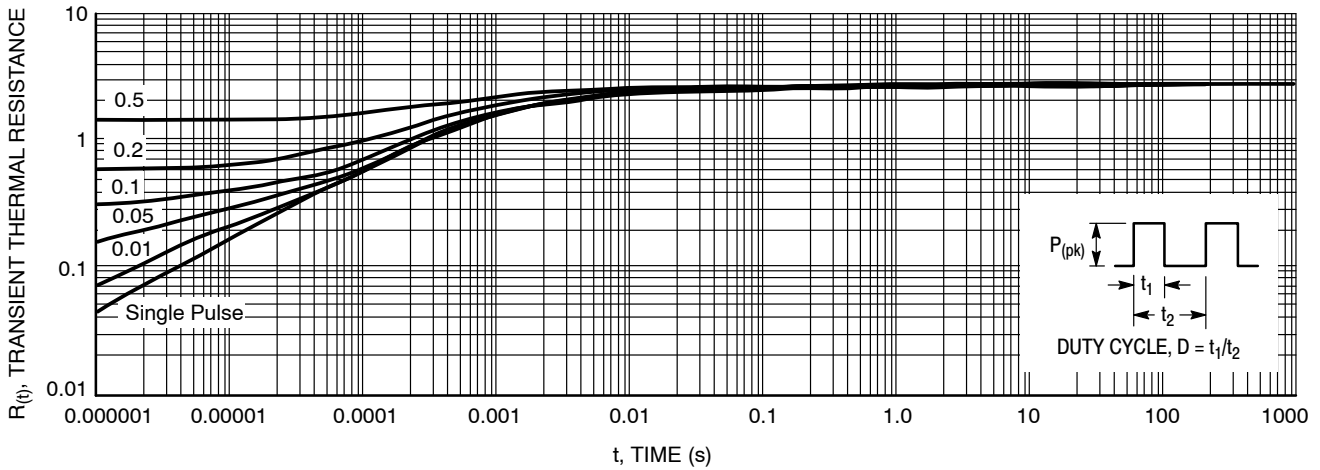

Figure 10. Thermal Response for MUR550PFG

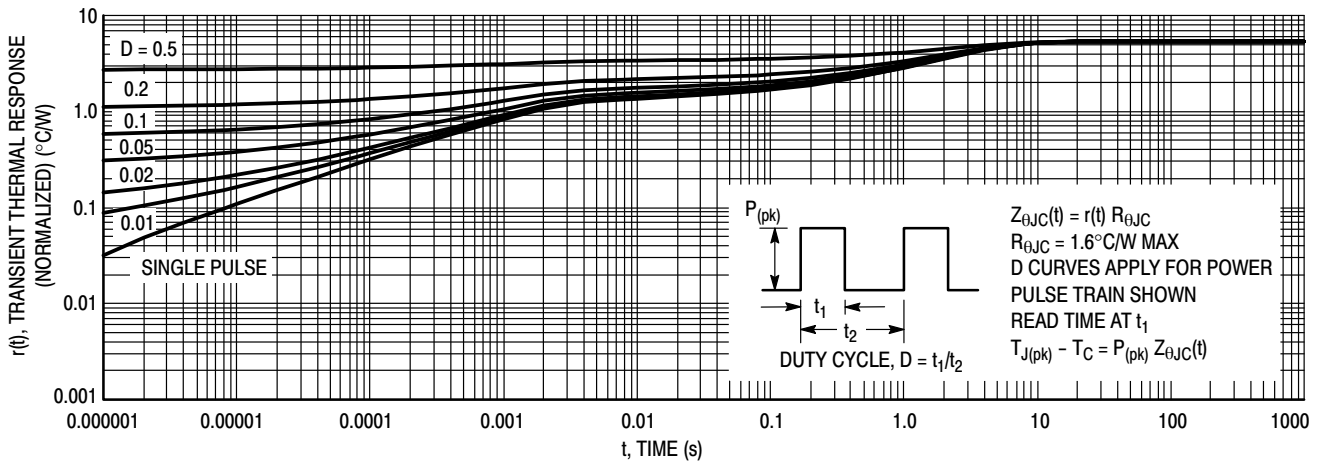

Figure 11. Thermal Response, (MURF550PFG) Junction-to-Case ($R_{\theta JC}$)

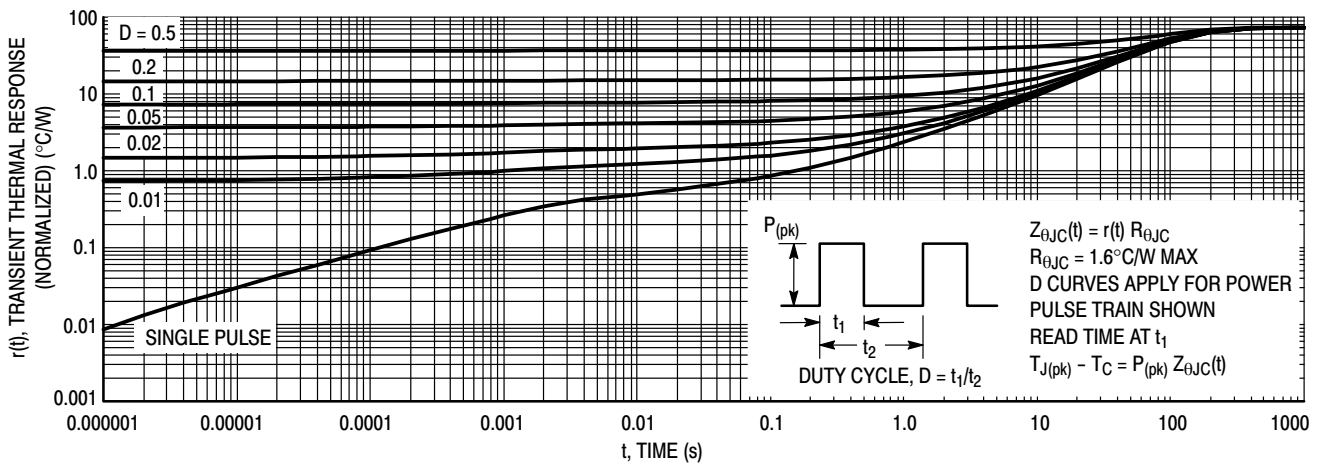

Figure 12. Thermal Response, (MURF550PFG) Junction-to-Ambient ($R_{\theta JA}$)

MECHANICAL CASE OUTLINE
PACKAGE DIMENSIONS

ON Semiconductor®



TO-220 FULLPAK, 2-LEAD
CASE 221E-01
ISSUE A

DATE 21 JAN 2008

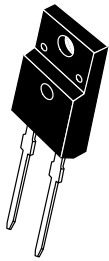

SCALE 1:1

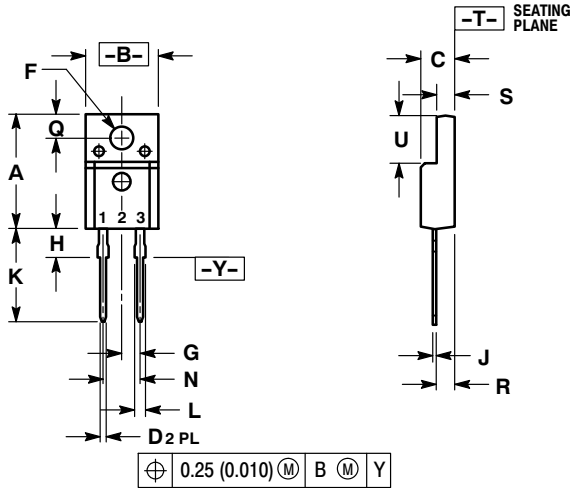

- NOTES:
- DIMENSIONING AND TOLERANCING PER ANSI Y14.5M, 1982.
 - CONTROLLING DIMENSION: INCH.

DIM	INCHES		MILLIMETERS	
	MIN	MAX	MIN	MAX
A	0.617	0.633	15.67	16.07
B	0.392	0.408	9.96	10.36
C	0.177	0.193	4.50	4.90
D	0.024	0.039	0.60	1.00
F	0.121	0.129	3.08	3.28
G	0.100 BSC		2.54 BSC	
H	0.117	0.133	2.98	3.38
J	0.018	0.025	0.45	0.64
K	0.499	0.562	12.68	14.27
L	0.045	0.060	1.14	1.52
N	0.200 BSC		5.08 BSC	
Q	0.122	0.138	3.10	3.50
R	0.101	0.117	2.56	2.96
S	0.092	0.108	2.34	2.74
U	0.255	0.271	6.48	6.88

- STYLE 1:
 PIN 1. CATHODE
 2. N/A
 3. ANODE

GENERIC MARKING DIAGRAM*



Rectifier

- A = Assembly Location
- Y = Year
- WW = Work Week
- G = Pb-Free Package
- xxxxxx = Device Code
- KA = Polarity Designator

*This information is generic. Please refer to device data sheet for actual part marking. Pb-Free indicator, "G" or microdot "▪", may or may not be present.

DOCUMENT NUMBER:	98ASB42851B	Electronic versions are uncontrolled except when accessed directly from the Document Repository. Printed versions are uncontrolled except when stamped "CONTROLLED COPY" in red.
STATUS:	ON SEMICONDUCTOR STANDARD	
NEW STANDARD:		
DESCRIPTION:	TO-220 FULLPAK, 2-LEAD	PAGE 1 OF 2

MECHANICAL CASE OUTLINE

PACKAGE DIMENSIONS

ON Semiconductor®



TO-220, 2-LEAD CASE 221B-04 ISSUE F

DATE 12 APR 2013

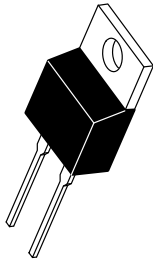

SCALE 1:1

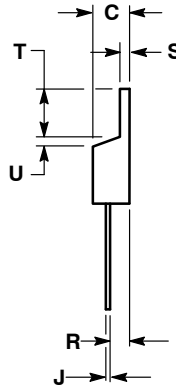
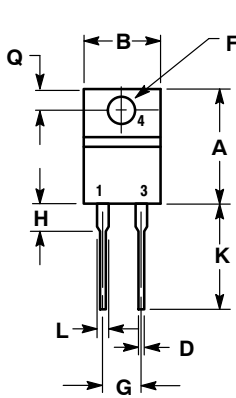

NOTES:

1. DIMENSIONING AND TOLERANCING PER ANSI Y14.5M, 1982.
2. CONTROLLING DIMENSION: INCH.

DIM	INCHES		MILLIMETERS	
	MIN	MAX	MIN	MAX
A	0.595	0.620	15.11	15.75
B	0.380	0.405	9.65	10.29
C	0.160	0.190	4.06	4.82
D	0.025	0.039	0.64	1.00
F	0.142	0.161	3.61	4.09
G	0.190	0.210	4.83	5.33
H	0.110	0.130	2.79	3.30
J	0.014	0.025	0.36	0.64
K	0.500	0.562	12.70	14.27
L	0.045	0.060	1.14	1.52
Q	0.100	0.120	2.54	3.04
R	0.080	0.110	2.04	2.79
S	0.045	0.055	1.14	1.39
T	0.235	0.255	5.97	6.48
U	0.000	0.050	0.000	1.27

STYLE 1:
PIN 1. CATHODE
2. N/A
3. ANODE
4. CATHODE

STYLE 2:
PIN 1. ANODE
2. N/A
3. CATHODE
4. ANODE

DOCUMENT NUMBER:	98ASB42149B	Electronic versions are uncontrolled except when accessed directly from the Document Repository. Printed versions are uncontrolled except when stamped "CONTROLLED COPY" in red.
DESCRIPTION:	TO-220, 2-LEAD	PAGE 1 OF 1

ON Semiconductor and are trademarks of Semiconductor Components Industries, LLC dba ON Semiconductor or its subsidiaries in the United States and/or other countries. ON Semiconductor reserves the right to make changes without further notice to any products herein. ON Semiconductor makes no warranty, representation or guarantee regarding the suitability of its products for any particular purpose, nor does ON Semiconductor assume any liability arising out of the application or use of any product or circuit, and specifically disclaims any and all liability, including without limitation special, consequential or incidental damages. ON Semiconductor does not convey any license under its patent rights nor the rights of others.



AXIAL LEAD
CASE 267-05
ISSUE G

DATE 06/06/2000

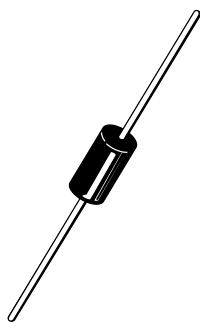

SCALE 1:1

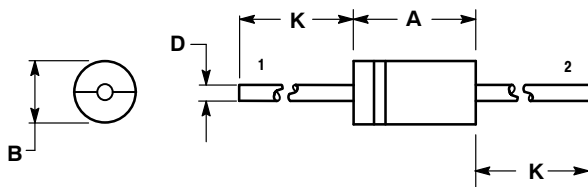

- NOTES:
1. DIMENSIONS AND TOLERANCING PER ANSI Y14.5M, 1982.
 2. CONTROLLING DIMENSION: INCH.
 3. 267-04 OBSOLETE, NEW STANDARD 267-05.

DIM	INCHES		MILLIMETERS	
	MIN	MAX	MIN	MAX
A	0.287	0.374	7.30	9.50
B	0.189	0.209	4.80	5.30
D	0.047	0.051	1.20	1.30
K	1.000	---	25.40	---

STYLE 1:
 PIN 1. CATHODE (POLARITY BAND)
 2. ANODE

STYLE 2:
 NO POLARITY

DOCUMENT NUMBER:	98ASB42170B	Electronic versions are uncontrolled except when accessed directly from the Document Repository. Printed versions are uncontrolled except when stamped "CONTROLLED COPY" in red.
DESCRIPTION:	AXIAL LEAD	PAGE 1 OF 1

ON Semiconductor and are trademarks of Semiconductor Components Industries, LLC dba ON Semiconductor or its subsidiaries in the United States and/or other countries. ON Semiconductor reserves the right to make changes without further notice to any products herein. ON Semiconductor makes no warranty, representation or guarantee regarding the suitability of its products for any particular purpose, nor does ON Semiconductor assume any liability arising out of the application or use of any product or circuit, and specifically disclaims any and all liability, including without limitation special, consequential or incidental damages. ON Semiconductor does not convey any license under its patent rights nor the rights of others.

**MECHANICAL CASE OUTLINE
PACKAGE DIMENSIONS**

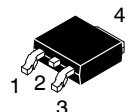

**DPAK (SINGLE GAUGE)
CASE 369C
ISSUE G**

DATE 31 MAY 2023

SCALE 1:1

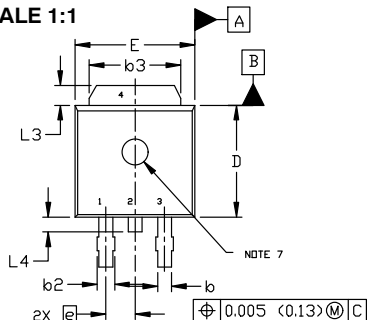

TOP VIEW

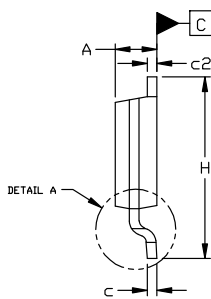

SIDE VIEW

NOTES:

1. DIMENSIONING AND TOLERANCING ASME Y14.5M, 1994.
2. CONTROLLING DIMENSION: INCHES
3. THERMAL PAD CONTOUR OPTIONAL WITHIN DIMENSIONS b3, L3, AND Z.
4. DIMENSIONS D AND E DO NOT INCLUDE MOLD FLASH, PROTRUSIONS, OR BURRS. MOLD FLASH, PROTRUSIONS, OR GATE BURRS SHALL NOT EXCEED 0.006 INCHES PER SIDE.
5. DIMENSIONS D AND E ARE DETERMINED AT THE OUTERMOST EXTREMES OF THE PLASTIC BODY.
6. DATUMS A AND B ARE DETERMINED AT DATUM PLANE H.
7. OPTIONAL MOLD FEATURE.

DIM	INCHES		MILLIMETERS	
	MIN.	MAX.	MIN.	MAX.
A	0.086	0.094	2.18	2.38
A1	0.000	0.005	0.00	0.13
b	0.025	0.035	0.63	0.89
b2	0.028	0.045	0.72	1.14
b3	0.180	0.215	4.57	5.46
c	0.018	0.024	0.46	0.61
c2	0.018	0.024	0.46	0.61
D	0.235	0.245	5.97	6.22
E	0.250	0.265	6.35	6.73
e	0.090	BSC	2.29	BSC
H	0.370	0.410	9.40	10.41
L	0.055	0.070	1.40	1.78
L1	0.114	REF	2.90	REF
L2	0.020	BSC	0.51	BSC
L3	0.035	0.050	0.89	1.27
L4	----	0.040	---	1.01
Z	0.155	----	3.93	---

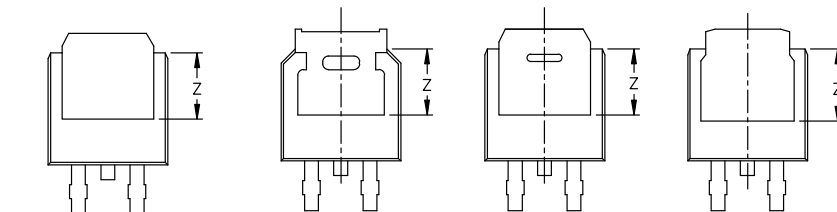

BOTTOM VIEW

BOTTOM VIEW

ALTERNATE CONSTRUCTIONS

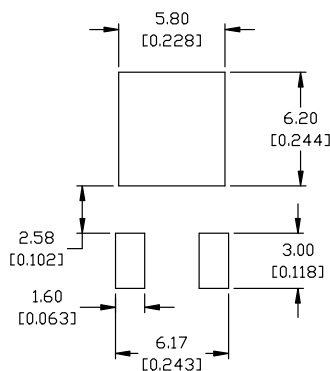

RECOMMENDED MOUNTING FOOTPRINT*

*FOR ADDITIONAL INFORMATION ON OUR Pb-FREE STRATEGY AND SOLDERING DETAILS, PLEASE DOWNLOAD THE ON SEMICONDUCTOR SOLDERING AND MOUNTING TECHNIQUES REFERENCE MANUAL, SOLDERM/D.

- | | | | | |
|---|---|--|--|---|
| STYLE 1:
PIN 1. BASE
2. COLLECTOR
3. EMITTER
4. COLLECTOR | STYLE 2:
PIN 1. GATE
2. DRAIN
3. SOURCE
4. DRAIN | STYLE 3:
PIN 1. ANODE
2. CATHODE
3. ANODE
4. CATHODE | STYLE 4:
PIN 1. CATHODE
2. ANODE
3. GATE
4. ANODE | STYLE 5:
PIN 1. GATE
2. ANODE
3. CATHODE
4. ANODE |
| STYLE 6:
PIN 1. MT1
2. MT2
3. GATE
4. MT2 | STYLE 7:
PIN 1. GATE
2. COLLECTOR
3. EMITTER
4. COLLECTOR | STYLE 8:
PIN 1. N/C
2. CATHODE
3. ANODE
4. CATHODE | STYLE 9:
PIN 1. ANODE
2. CATHODE
3. RESISTOR ADJUST
4. CATHODE | STYLE 10:
PIN 1. CATHODE
2. ANODE
3. CATHODE
4. ANODE |

GENERIC MARKING DIAGRAM*

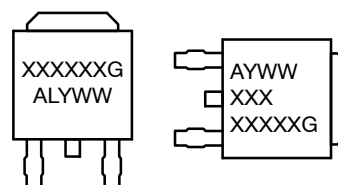

- IC** **Discrete**
- XXXXXX = Device Code
 A = Assembly Location
 L = Wafer Lot
 Y = Year
 WW = Work Week
 G = Pb-Free Package

*This information is generic. Please refer to device data sheet for actual part marking. Pb-Free indicator, "G" or microdot "•", may or may not be present. Some products may not follow the Generic Marking.

DOCUMENT NUMBER:	98AON10527D	Electronic versions are uncontrolled except when accessed directly from the Document Repository. Printed versions are uncontrolled except when stamped "CONTROLLED COPY" in red.
DESCRIPTION:	DPAK (SINGLE GAUGE)	PAGE 1 OF 1

onsemi and Onsemi are trademarks of Semiconductor Components Industries, LLC dba onsemi or its subsidiaries in the United States and/or other countries. onsemi reserves the right to make changes without further notice to any products herein. onsemi makes no warranty, representation or guarantee regarding the suitability of its products for any particular purpose, nor does onsemi assume any liability arising out of the application or use of any product or circuit, and specifically disclaims any and all liability, including without limitation special, consequential or incidental damages. onsemi does not convey any license under its patent rights nor the rights of others.

onsemi, **Onsemi**, and other names, marks, and brands are registered and/or common law trademarks of Semiconductor Components Industries, LLC dba "**onsemi**" or its affiliates and/or subsidiaries in the United States and/or other countries. **onsemi** owns the rights to a number of patents, trademarks, copyrights, trade secrets, and other intellectual property. A listing of **onsemi**'s product/patent coverage may be accessed at www.onsemi.com/site/pdf/Patent-Marking.pdf. **onsemi** reserves the right to make changes at any time to any products or information herein, without notice. The information herein is provided "as-is" and **onsemi** makes no warranty, representation or guarantee regarding the accuracy of the information, product features, availability, functionality, or suitability of its products for any particular purpose, nor does **onsemi** assume any liability arising out of the application or use of any product or circuit, and specifically disclaims any and all liability, including without limitation special, consequential or incidental damages. Buyer is responsible for its products and applications using **onsemi** products, including compliance with all laws, regulations and safety requirements or standards, regardless of any support or applications information provided by **onsemi**. "Typical" parameters which may be provided in **onsemi** data sheets and/or specifications can and do vary in different applications and actual performance may vary over time. All operating parameters, including "Typicals" must be validated for each customer application by customer's technical experts. **onsemi** does not convey any license under any of its intellectual property rights nor the rights of others. **onsemi** products are not designed, intended, or authorized for use as a critical component in life support systems or any FDA Class 3 medical devices or medical devices with a same or similar classification in a foreign jurisdiction or any devices intended for implantation in the human body. Should Buyer purchase or use **onsemi** products for any such unintended or unauthorized application, Buyer shall indemnify and hold **onsemi** and its officers, employees, subsidiaries, affiliates, and distributors harmless against all claims, costs, damages, and expenses, and reasonable attorney fees arising out of, directly or indirectly, any claim of personal injury or death associated with such unintended or unauthorized use, even if such claim alleges that **onsemi** was negligent regarding the design or manufacture of the part. **onsemi** is an Equal Opportunity/Affirmative Action Employer. This literature is subject to all applicable copyright laws and is not for resale in any manner.

ADDITIONAL INFORMATION

TECHNICAL PUBLICATIONS:

Technical Library: www.onsemi.com/design/resources/technical-documentation
onsemi Website: www.onsemi.com

ONLINE SUPPORT: www.onsemi.com/support

For additional information, please contact your local Sales Representative at www.onsemi.com/support/sales