

# NSS1C200L, NSV1C200L

## 100 V, 2.0 A, Low $V_{CE(sat)}$ PNP Transistor

ON Semiconductor's e<sup>2</sup>PowerEdge family of low  $V_{CE(sat)}$  transistors are miniature surface mount devices featuring ultra low saturation voltage ( $V_{CE(sat)}$ ) and high current gain capability. These are designed for use in low voltage, high speed switching applications where affordable efficient energy control is important.

Typical applications are DC-DC converters and power management in portable and battery powered products such as cellular and cordless phones, PDAs, computers, printers, digital cameras and MP3 players. Other applications are low voltage motor controls in mass storage products such as disc drives and tape drives. In the automotive industry they can be used in air bag deployment and in the instrument cluster. The high current gain allows e<sup>2</sup>PowerEdge devices to be driven directly from PMU's control outputs, and the Linear Gain (Beta) makes them ideal components in analog amplifiers.

### Features

- NSV Prefix for Automotive and Other Applications Requiring Unique Site and Control Change Requirements; AEC-Q101 Qualified and PPAP Capable
- These Devices are Pb-Free, Halogen Free/BFR Free and are RoHS Compliant

### MAXIMUM RATINGS ( $T_A = 25^\circ\text{C}$ )

Rating	Symbol	Max	Unit
Collector-Emitter Voltage	$V_{CEO}$	-100	Vdc
Collector-Base Voltage	$V_{CBO}$	-140	Vdc
Emitter-Base Voltage	$V_{EBO}$	-7.0	Vdc
Collector Current – Continuous	$I_C$	-2.0	A
Collector Current – Peak	$I_{CM}$	-3.0	A

### THERMAL CHARACTERISTICS

Characteristic	Symbol	Max	Unit
Total Device Dissipation $T_A = 25^\circ\text{C}$ Derate above $25^\circ\text{C}$	$P_D$ (Note 1)	490	mW
Thermal Resistance, Junction-to-Ambient	$R_{\theta JA}$ (Note 1)	255	$^\circ\text{C}/\text{W}$
Total Device Dissipation $T_A = 25^\circ\text{C}$ Derate above $25^\circ\text{C}$	$P_D$ (Note 2)	710	mW
Thermal Resistance, Junction-to-Ambient	$R_{\theta JA}$ (Note 2)	176	$^\circ\text{C}/\text{W}$
Junction and Storage Temperature Range	$T_J, T_{stg}$	-55 to +150	$^\circ\text{C}$

Stresses exceeding those listed in the Maximum Ratings table may damage the device. If any of these limits are exceeded, device functionality should not be assumed, damage may occur and reliability may be affected.

1. FR-4 @ 100 mm<sup>2</sup>, 1 oz. copper traces.
2. FR-4 @ 500 mm<sup>2</sup>, 1 oz. copper traces.



ON Semiconductor®

[www.onsemi.com](http://www.onsemi.com)

## -100 VOLTS, 2.0 AMPS PNP LOW $V_{CE(sat)}$ TRANSISTOR

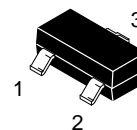
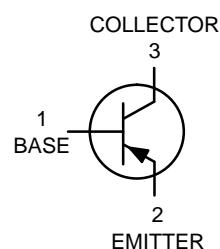

SOT-23 (TO-236)  
CASE 318  
STYLE 6

### MARKING DIAGRAM

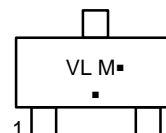

VL = Specific Device Code  
M = Date Code\*  
■ = Pb-Free Package

(Note: Microdot may be in either location)

\*Date Code orientation and/or overbar may vary depending upon manufacturing location.

### ORDERING INFORMATION

Device	Package	Shipping†
NSS1C200LT1G, NSV1C200LT1G	SOT-23 (Pb-Free)	3000/Tape & Reel

†For information on tape and reel specifications, including part orientation and tape sizes, please refer to our Tape and Reel Packaging Specification Brochure, BRD8011/D.

# NSS1C200L, NSV1C200L

## ELECTRICAL CHARACTERISTICS ( $T_A = 25^\circ\text{C}$ unless otherwise noted)

Characteristic	Symbol	Min	Typ	Max	Unit
<b>OFF CHARACTERISTICS</b>					
Collector–Emitter Breakdown Voltage ( $I_C = -10\text{ mA}$ , $I_B = 0$ )	$V_{(BR)CEO}$	-100			Vdc
Collector–Base Breakdown Voltage ( $I_C = -0.1\text{ mA}$ , $I_E = 0$ )	$V_{(BR)CBO}$	-140			Vdc
Emitter–Base Breakdown Voltage ( $I_E = -0.1\text{ mA}$ , $I_C = 0$ )	$V_{(BR)EBO}$	-7.0			Vdc
Collector Cutoff Current ( $V_{CB} = -140\text{ Vdc}$ , $I_E = 0$ )	$I_{CBO}$			-100	nAdc
Emitter Cutoff Current ( $V_{EB} = -6.0\text{ Vdc}$ )	$I_{EBO}$			-50	nAdc

## ON CHARACTERISTICS

DC Current Gain (Note 3) ( $I_C = -10\text{ mA}$ , $V_{CE} = -2.0\text{ V}$ ) ( $I_C = -500\text{ mA}$ , $V_{CE} = -2.0\text{ V}$ ) ( $I_C = -1.0\text{ A}$ , $V_{CE} = -2.0\text{ V}$ ) ( $I_C = -2.0\text{ A}$ , $V_{CE} = -2.0\text{ V}$ )	$h_{FE}$	150 120 80 50	240	360	
Collector–Emitter Saturation Voltage (Note 3) ( $I_C = -0.1\text{ A}$ , $I_B = -0.01\text{ A}$ ) ( $I_C = -0.5\text{ A}$ , $I_B = -0.05\text{ A}$ ) ( $I_C = -1.0\text{ A}$ , $I_B = -0.100\text{ A}$ ) ( $I_C = -2.0\text{ A}$ , $I_B = -0.200\text{ A}$ )	$V_{CE(sat)}$			-0.040 -0.080 -0.115 -0.250	V
Base–Emitter Saturation Voltage (Note 3) ( $I_C = -1.0\text{ A}$ , $I_B = -0.100\text{ A}$ )	$V_{BE(sat)}$			-0.950	V
Base–Emitter Turn–on Voltage (Note 3) ( $I_C = -1.0\text{ A}$ , $V_{CE} = -2.0\text{ V}$ )	$V_{BE(on)}$			-0.850	V
Cutoff Frequency ( $I_C = -100\text{ mA}$ , $V_{CE} = -5.0\text{ V}$ , $f = 100\text{ MHz}$ )	$f_T$		120		MHz
Input Capacitance ( $V_{EB} = 2.0\text{ V}$ , $f = 1.0\text{ MHz}$ )	$C_{ibo}$		200		pF
Output Capacitance ( $V_{CB} = 10\text{ V}$ , $f = 1.0\text{ MHz}$ )	$C_{obo}$		22		pF

Product parametric performance is indicated in the Electrical Characteristics for the listed test conditions, unless otherwise noted. Product performance may not be indicated by the Electrical Characteristics if operated under different conditions.

3. Pulsed Condition: Pulse Width = 300 msec, Duty Cycle  $\leq 2\%$ .

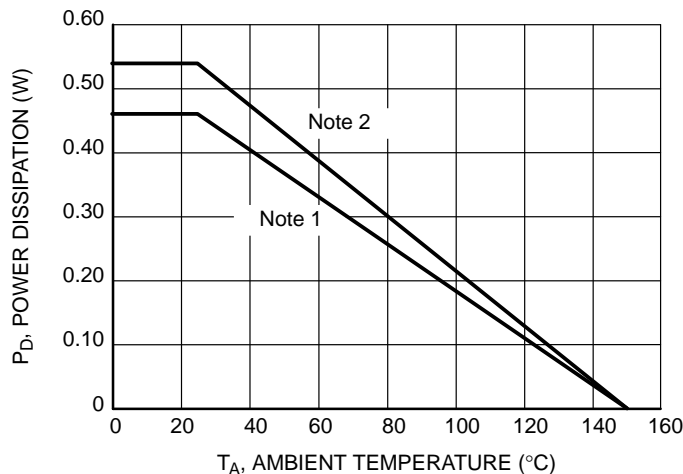

**Figure 1. Power Derating**

# NSS1C200L, NSV1C200L

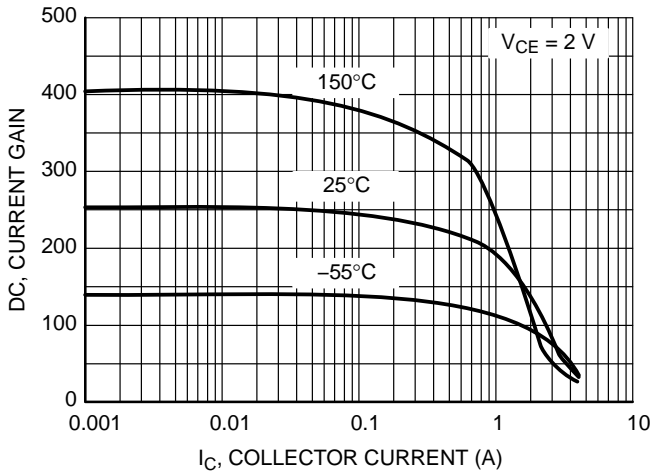

Figure 2. DC Current Gain

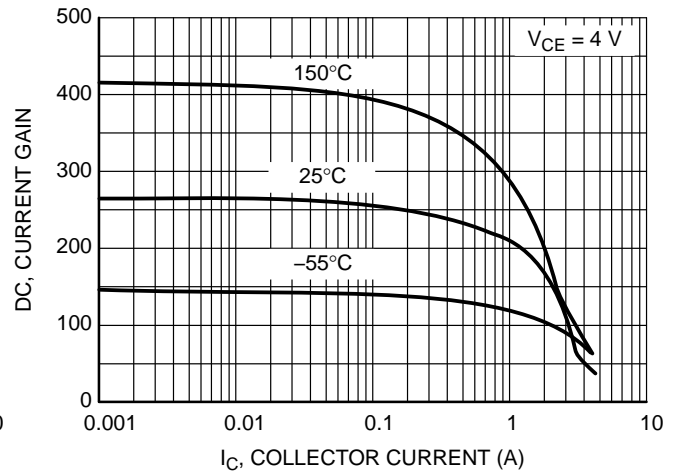

Figure 3. DC Current Gain

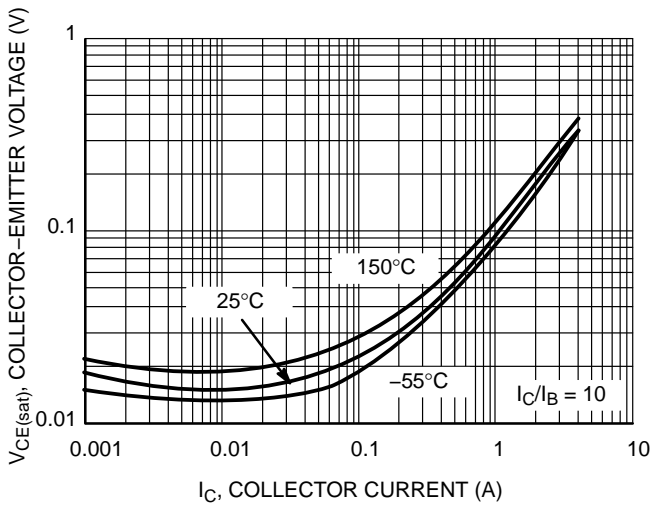

Figure 4. Collector-Emitter Saturation Voltage

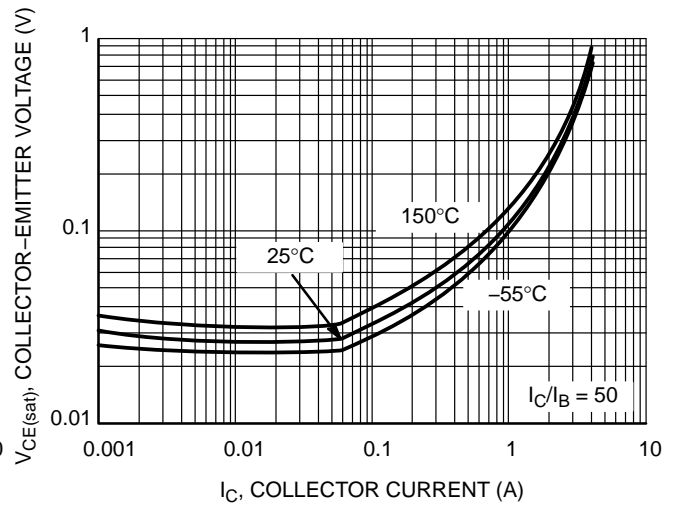

Figure 5. Collector-Emitter Saturation Voltage

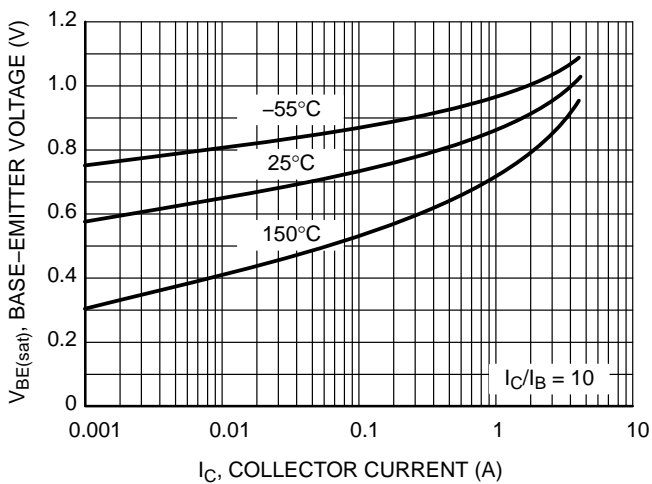

Figure 6. Base-Emitter Saturation Voltage

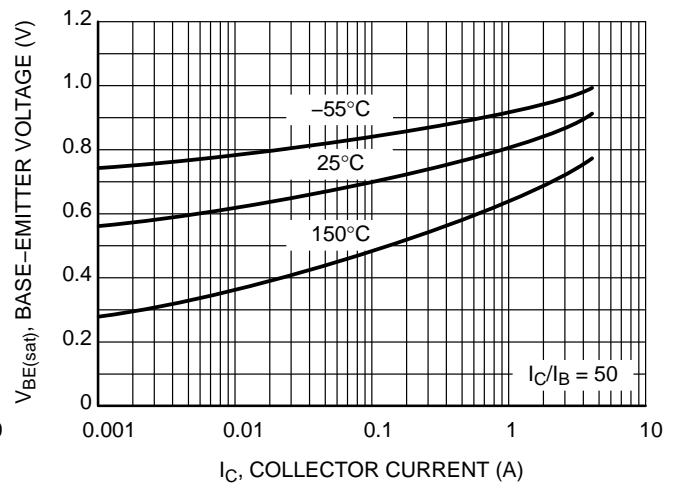

Figure 7. Base-Emitter Saturation Voltage

# NSS1C200L, NSV1C200L

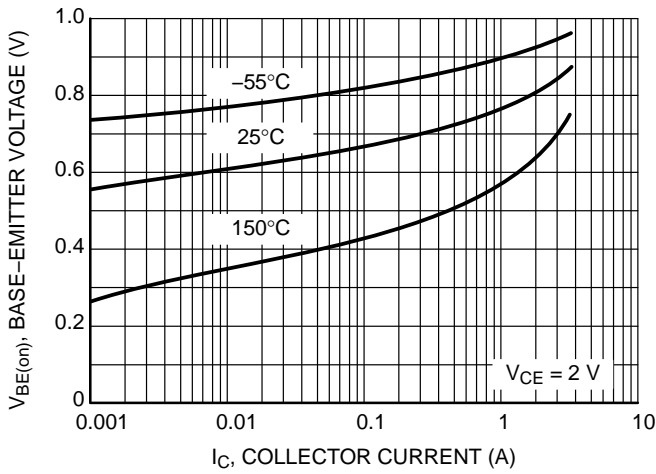

Figure 8. Base-Emitter Saturation Voltage

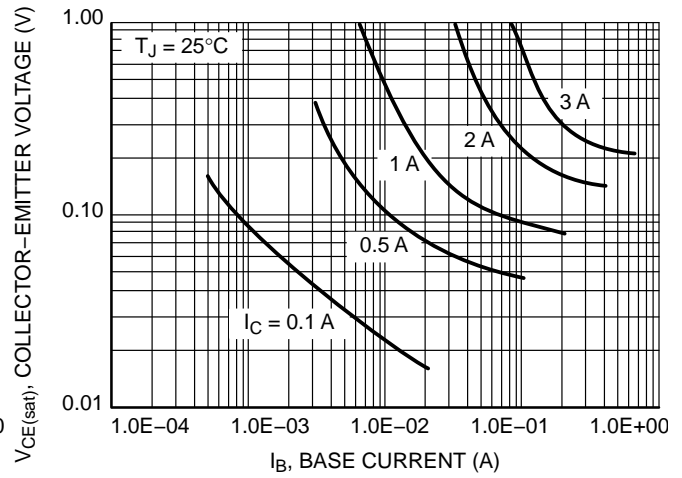

Figure 9. Collector Saturation Region

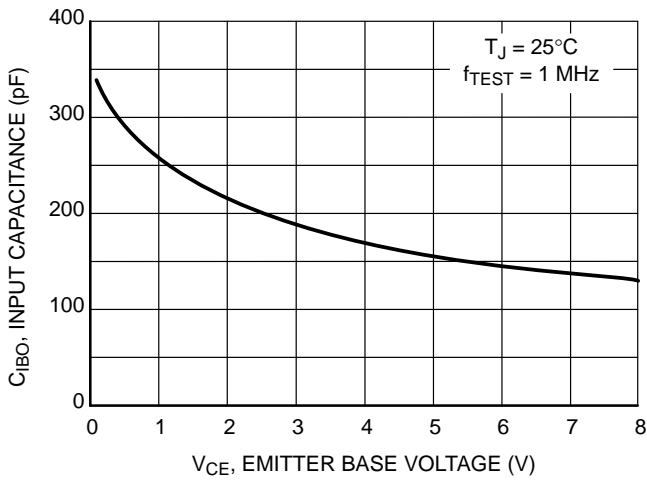

Figure 10. Input Capacitance

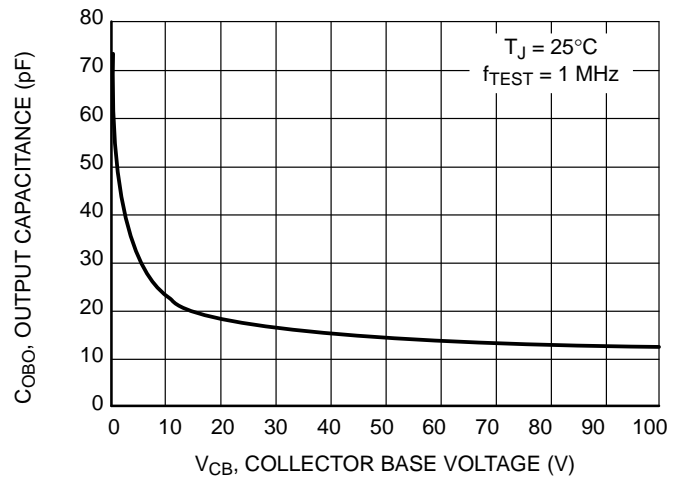

Figure 11. Output Capacitance

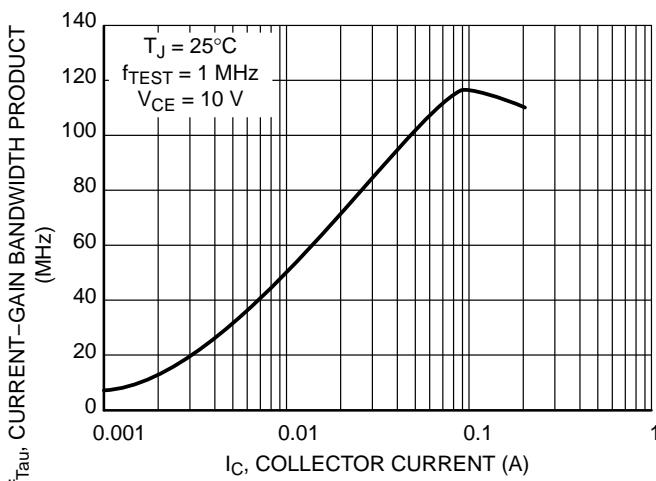

Figure 12. Current-Gain Bandwidth Product

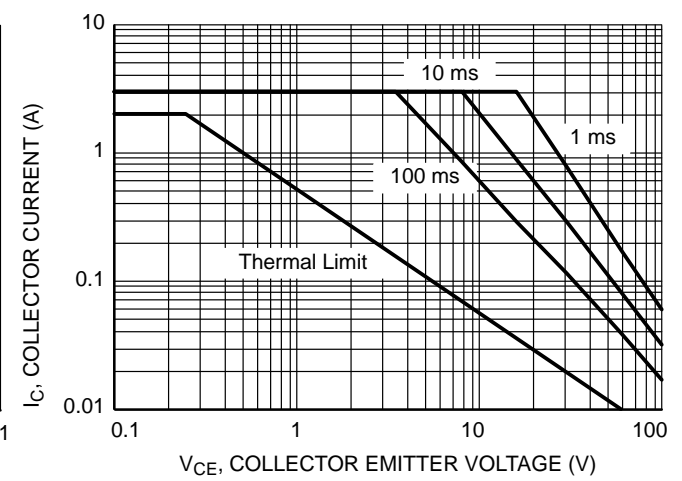

Figure 13.

# NSS1C200L, NSV1C200L

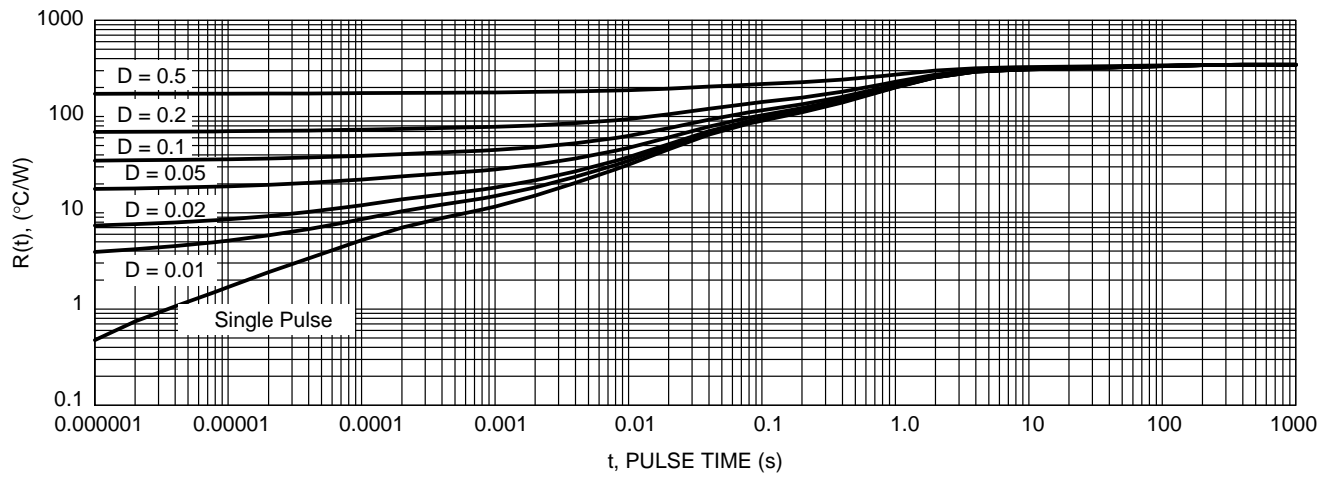
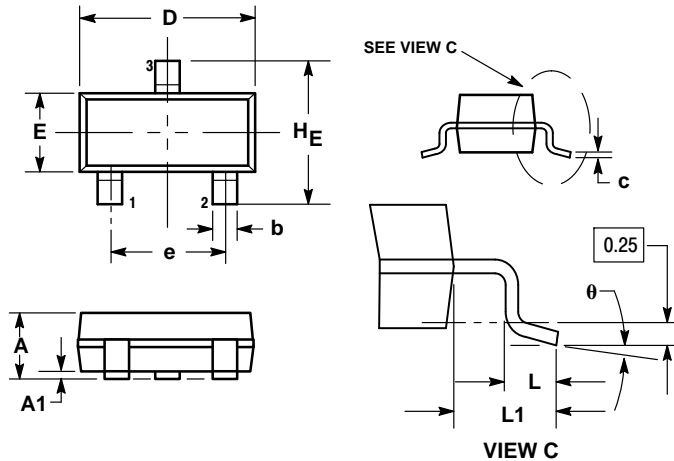

Figure 14. Transient Thermal Resistance

# NSS1C200L, NSV1C200L

## PACKAGE DIMENSIONS

SOT-23 (TO-236)  
CASE 318-08  
ISSUE AP



- NOTES:
1. DIMENSIONING AND TOLERANCING PER ANSI Y14.5M, 1982.
  2. CONTROLLING DIMENSION: INCH.
  3. MAXIMUM LEAD THICKNESS INCLUDES LEAD FINISH THICKNESS. MINIMUM LEAD THICKNESS IS THE MINIMUM THICKNESS OF BASE MATERIAL.
  4. DIMENSIONS D AND E DO NOT INCLUDE MOLD FLASH, PROTRUSIONS, OR GATE BURRS.

DIM	MILLIMETERS			INCHES		
	MIN	NOM	MAX	MIN	NOM	MAX
A	0.89	1.00	1.11	0.035	0.040	0.044
A1	0.01	0.06	0.10	0.001	0.002	0.004
b	0.37	0.44	0.50	0.015	0.018	0.020
c	0.09	0.13	0.18	0.003	0.005	0.007
D	2.80	2.90	3.04	0.110	0.114	0.120
E	1.20	1.30	1.40	0.047	0.051	0.055
e	1.78	1.90	2.04	0.070	0.075	0.081
L	0.10	0.20	0.30	0.004	0.008	0.012
L1	0.35	0.54	0.69	0.014	0.021	0.029
HE	2.10	2.40	2.64	0.083	0.094	0.104
θ	0°	---	10°	0°	---	10°

- STYLE 6:  
PIN 1. BASE  
2. EMITTER  
3. COLLECTOR

### SOLDERING FOOTPRINT\*

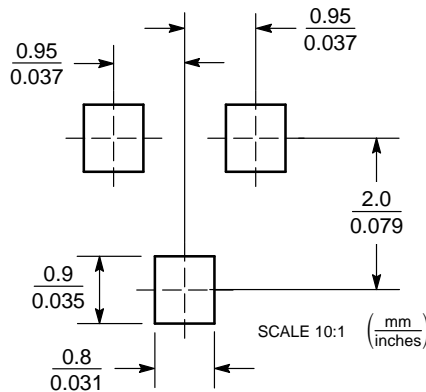

\*For additional information on our Pb-Free strategy and soldering details, please download the ON Semiconductor Soldering and Mounting Techniques Reference Manual, SOLDERRM/D.

ON Semiconductor and the  are registered trademarks of Semiconductor Components Industries, LLC (SCILLC) or its subsidiaries in the United States and/or other countries. SCILLC owns the rights to a number of patents, trademarks, copyrights, trade secrets, and other intellectual property. A listing of SCILLC's product/patent coverage may be accessed at [www.onsemi.com/site/pdf/Patent-Marketing.pdf](http://www.onsemi.com/site/pdf/Patent-Marketing.pdf). SCILLC reserves the right to make changes without further notice to any products herein. SCILLC makes no warranty, representation or guarantee regarding the suitability of its products for any particular purpose, nor does SCILLC assume any liability arising out of the application or use of any product or circuit, and specifically disclaims any and all liability, including without limitation special, consequential or incidental damages. "Typical" parameters which may be provided in SCILLC data sheets and/or specifications can and do vary in different applications and actual performance may vary over time. All operating parameters, including "Typicals" must be validated for each customer application by customer's technical experts. SCILLC does not convey any license under its patent rights nor the rights of others. SCILLC products are not designed, intended, or authorized for use as components in systems intended for surgical implant into the body, or other applications intended to support or sustain life, or for any other application in which the failure of the SCILLC product could create a situation where personal injury or death may occur. Should Buyer purchase or use SCILLC products for any such unintended or unauthorized application, Buyer shall indemnify and hold SCILLC and its officers, employees, subsidiaries, affiliates, and distributors harmless against all claims, costs, damages, and expenses, and reasonable attorney fees arising out of, directly or indirectly, any claim of personal injury or death associated with such unintended or unauthorized use, even if such claim alleges that SCILLC was negligent regarding the design or manufacture of the part. SCILLC is an Equal Opportunity/Affirmative Action Employer. This literature is subject to all applicable copyright laws and is not for resale in any manner.

### PUBLICATION ORDERING INFORMATION

**LITERATURE FULFILLMENT:**  
Literature Distribution Center for ON Semiconductor  
P.O. Box 5163, Denver, Colorado 80217 USA  
**Phone:** 303-675-2175 or 800-344-3860 Toll Free USA/Canada  
**Fax:** 303-675-2176 or 800-344-3867 Toll Free USA/Canada  
**Email:** [orderlit@onsemi.com](mailto:orderlit@onsemi.com)

**N. American Technical Support:** 800-282-9855 Toll Free  
USA/Canada  
**Europe, Middle East and Africa Technical Support:**  
Phone: 421 33 790 2910  
**Japan Customer Focus Center**  
Phone: 81-3-5817-1050

**ON Semiconductor Website:** [www.onsemi.com](http://www.onsemi.com)  
**Order Literature:** <http://www.onsemi.com/orderlit>

For additional information, please contact your local Sales Representative