

High Reliability Reinforced Isolated Sigma-Delta Modulator

Datasheet (EN) 1.6

Product Overview

The NSi1306 is a high performance Σ - Δ modulator with output separated from input based on the NOVOSENSE capacitive isolation technology. The device has a linear differential input signal range of $\pm 50\text{mV}$ ($\pm 64\text{mV}$ full-scale) or $\pm 250\text{mV}$ ($\pm 320\text{mV}$ full-scale). The differential input is ideally suited to shunt resistor-based current sensing in high voltage applications where isolation is required.

The analog input is amplified and continuously sampled by a second-order Σ - Δ modulator and converted to a high speed, single bit data stream. The output data is synchronous to the external clock with a frequency range from 5MHz to 21MHz. By using an appropriate digital filter (such as sinc3 filter) to decimate the bitstream, the device can achieve 16 bits resolution and an 86dB/82.5dB signal to noise ratio (SNR) at 78.125kSPS with a 20MHz master clock.

The fail-safe functions including input common-mode overvoltage detection and missing AVDD detection simplify system-level design and diagnostics.

Key Features

- Up to 5000V_{RMS} Insulation Voltage
- Clock frequency: 5MHz to 21MHz
- $\pm 50\text{mV}$ or $\pm 250\text{mV}$ Linear Input Voltage Range
- Excellent DC Performance:
 - Offset Error: $\pm 50\mu\text{V}$ or $\pm 100\mu\text{V}$ (Max)
 - Offset Drift: $-0.5\sim 1.5\mu\text{V}/^\circ\text{C}$ (Max)
 - Gain Error: $\pm 0.2\%$ (Max)
 - Gain Drift: $\pm 40\text{ppm}/^\circ\text{C}$ (Max)
- SNR: 82.5dB or 86dB (Typ)
- High CMTI: 150kV/ μs (Typ)
- System-Level Diagnostic Features:
 - AVDD monitoring
 - Input common-mode overvoltage detection

- Operation Temperature: $-40^\circ\text{C}\sim 125^\circ\text{C}$
- RoHS-Compliant Packages:
 - SOP8(300mil)
 - SOP16(300mil)

Safety Regulatory Approvals

- UL recognition: up to 5000V_{rms} for 1 minute per UL1577
- CQC certification per GB4943.1-2011
- CSA component notice 5A approval IEC60950-1 standard
- DIN VDE V 0884-11:2017-01

Applications

- Shunt current monitoring
- AC motor controls
- Power and solar inverters
- Uninterruptible Power Suppliers
- Automotive onboard chargers

Device Information

Part Number	Package	Body Size
NSi1306x-DSWVR	SOP8(300mil)	5.85mm × 7.50mm
NSi1306x-DSWR	SOP16(300mil)	10.30mm × 7.50mm

Functional Block Diagrams

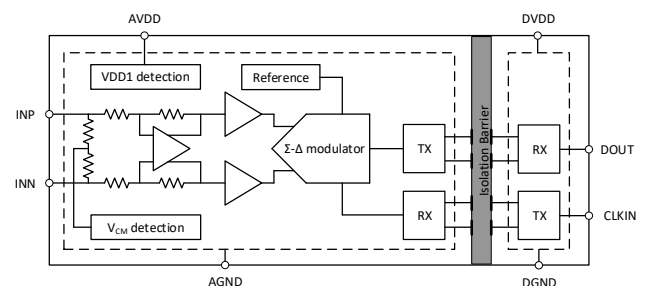

Figure 1. NSi1306 Block Diagram

INDEX

1. PIN CONFIGURATION AND FUNCTIONS	3
2. ABSOLUTE MAXIMUM RATINGS.....	5
3. RECOMMENDED OPERATING CONDITIONS	5
4. THERMAL INFORMATION	5
5. SPECIFICATIONS	6
5.1. ELECTRICAL CHARACTERISTICS: NSI1306M05	6
5.2. ELECTRICAL CHARACTERISTICS: NSI1306M25	8
5.3. TYPICAL PERFORMANCE CHARACTERISTICS	10
6. HIGH VOLTAGE FEATURE DESCRIPTION	14
6.1. INSULATION AND SAFETY RELATED SPECIFICATIONS	14
6.2. INSULATION CHARACTERISTICS.....	14
6.3. REGULATORY INFORMATION.....	15
7. FUNCTION DESCRIPTION	16
7.1. OVERVIEW.....	16
7.2. ANALOG INPUT	16
7.3. DIGITAL INPUT	16
7.4. DIGITAL OUTPUT	16
7.5. FAIL-SAFE OUTPUT	17
8. APPLICATION NOTE	18
8.1. TYPICAL APPLICATION CIRCUIT	18
8.2. SHUNT RESISTOR SELECTION	18
8.3. DIGITAL FILTER.....	18
8.4. PCB LAYOUT	19
9. PACKAGE INFORMATION.....	20
10. ORDERING INFORMATION	23
11. DOCUMENTATION SUPPORT	23
12. TAPE AND REEL INFORMATION	24
13. REVISION HISTORY	26

1. Pin Configuration and Functions

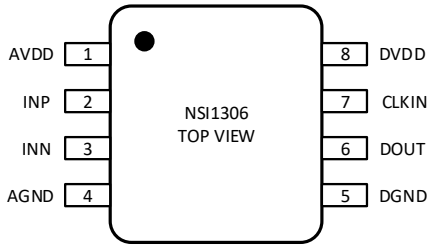

Figure 1.1 NSi1306 Package (SOP8(300mil))

Table 1.1 NSi1306 Pin Configuration and Description

<i>NSi1306 PIN NO.</i>	<i>SYMBOL</i>	<i>FUNCTION</i>
1	AVDD	Power supply for analog side (3.0V to 5.5V)
2	INP	Positive analog input (±250mV recommended for NSi1306M25 and ±50mV recommended for NSi1306M05)
3	INN	Negative analog input
4	AGND	Analog ground reference
5	DGND	Digital ground reference
6	DOUT	Modulator data output
7	CLKIN	Modulator clock input: 5~21MHz
8	DVDD	Power supply for digital side (3.0V to 5.5V)

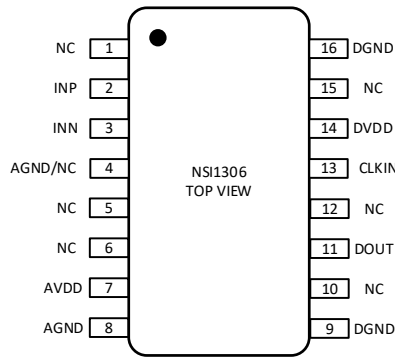

Figure 1.2 NSi1306 Package (SOP16(300mil))

Table 1.2 NSi1306 Pin Configuration and Description

NSi1306 PIN NO.	SYMBOL	FUNCTION
1	NC	Internally connected to AVDD, this pin can be left floating or tied to AVDD
2	INP	Positive analog input (±250mV recommended for NSi1306M25 and ±50mV recommended for NSi1306M05)
3	INN	Negative analog input
4	AGND/NC	Not internally connected. This pin can be tied to AGND, or leave floating.
5	NC	Not internally connected, this pin can be left floating or tied to AVDD, AGND
6	NC	Not internally connected, this pin can be left floating or tied to AVDD, AGND
7	AVDD	Power supply for analog side (3.0V to 5.5V)
8	AGND	Analog ground reference
9	DGND	Digital ground reference
10	NC	Not internally connected, this pin can be left floating or tied to DVDD, DGND
11	DOUT	Modulator data output
12	NC	Not internally connected, this pin can be left floating or tied to DVDD, DGND
13	CLKIN	Modulator clock input: 5~21MHz
14	DVDD	Power supply for digital side (3.0V to 5.5V)
15	NC	Not internally connected, this pin can be left floating or tied to DVDD, DGND
16	DGND	Digital ground reference

2. Absolute Maximum Ratings

Parameters	Symbol	Min	Typ	Max	Unit
Power Supply Voltage	AVDD, DVDD	-0.3		6.5	V
Analog Input Voltage	INP, INN	AGND-6		AVDD+0.5	V
Digital Input Voltage	CLKIN	DGND-0.5		DVDD+0.5	V
Digital Output Voltage	DOUT	DGND-0.5		DVDD+0.5	V
Output current per Output Pin	I _o	-10		10	mA
Operating Temperature	T _{OPR}	-40		125	°C
Junction Temperature	T _J	-40		150	°C
Storage Temperature	T _{STG}	-55		150	°C
Electrostatic discharge	HBM ⁽¹⁾	±2000			V
	CDM ⁽²⁾	±1000			V

(1) Human body model (HBM), per AEC-Q100-002-RevD

(2) Charged device model (CDM), per AEC-Q100-011-RevB

3. Recommended Operating Conditions

Parameters	Symbol	Min	Typ	Max	Unit
Analog Side Power Supply	AVDD	3.0	5.0	5.5	V
Digital Side Power Supply	DVDD	3.0	3.3	5.5	V
NSI1306M05	Differential input voltage before clipping output	V _{Clipping}	±64		mV
	Linear differential input full scale voltage	V _{FSR}	-50	50	mV
	Operating common-mode input voltage	V _{CM}	-0.032	0.8	V
NSI1306M25	Differential input voltage before clipping output	V _{Clipping}	±320		mV
	Linear differential input full scale voltage	V _{FSR}	-250	250	mV
	Operating common-mode input voltage	V _{CM}	-0.16	0.8	V
Operating Ambient Temperature	T _A	-40		125	°C

4. Thermal Information

Parameters	Symbol	SOP8(300mil)	SOP16(300mil)	Unit
Junction-to-ambient thermal resistance	R _{θJA}	86	82	°C/W

Parameters	Symbol	SOP8(300mil)	SOP16(300mil)	Unit
Junction-to-case (top) thermal resistance	$R_{\theta JC(top)}$	28	42	°C/W
Junction-to-board thermal resistance	$R_{\theta JB}$	42	46	°C/W
Junction-to-top characterization parameter	Ψ_{JT}	4	12	°C/W
Junction-to-board characterization parameter	Ψ_{JB}	42	46	°C/W

5. Specifications

5.1. Electrical Characteristics: NSI1306M05

(AVDD = 3.0V ~ 5.5V, DVDD = 3.0V ~ 5.5V, INP = -50mV to +50mV, and INN = AGND = 0V, T_A = -40°C to 125°C and sinc³ filter with OSR=256. Unless otherwise noted, Typical values are at CLKIN=20MHz, AVDD = 5V, DVDD = 3.3V, T_A = 25°C)

Parameters	Symbol	Min	Typ	Max	Unit	Comments
Power Supply						
Analog Side Supply Voltage	AVDD	3.0	5.0	5.5	V	
Digital Side Supply Voltage	DVDD	3.0	3.3	5.5	V	
Analog Side Supply Current	IAVDD		11.5	15	mA	
Digital Side Supply Current	IDVDD		2	2.5	mA	
AVDD undervoltage detection threshold voltage	AVDD _{UV}	2	2.5	3	V	AVDD falling
Analog Input						
Common-mode overvoltage detection level	V _{CMov}	0.9			V	Detection level has a typical hysteresis of 96 mV
Common-mode rejection ratio	CMRR _{dc}		-95		dB	INP = INN, $f_{IN} = 0$ Hz, $V_{CM\ min} \leq V_{IN} \leq V_{CM\ max}$
	CMRR _{ac}		-99		dB	INP = INN, $f_{IN} = 10$ kHz, $V_{CM\ min} \leq V_{IN} \leq V_{CM\ max}$
Single-ended input resistance	R _{IN}		4.75		kΩ	INN = AGND
Differential input resistance	R _{IND}		4.9		kΩ	
Input capacitance	C _I		2		pF	
Input bias current	I _{IB}	-24	-23	-20	μA	INP = INN = AGND, $I_{IB} = (I_{IBP} + I_{IBN}) / 2$
Input bias current drift	TC _{I_{IB}}		±2		nA/°C	
Common-mode transient immunity	CMTI	100	150		kV/μs	Common-mode transient immunity
DC Accuracy						
Differential nonlinearity	DNL	-0.99		0.99	LSB	
Integral nonlinearity	INL	-4	±1	4	LSB	

Parameters	Symbol	Min	Typ	Max	Unit	Comments
Offset error	E_O	-50	± 2.5	50	μV	INP = INN = AGND
Offset error thermal drift	TCE_O	-0.5	± 0.15	0.5	$\mu\text{V}/^\circ\text{C}$	
Gain error	E_G	-0.2%	$\pm 0.005\%$	0.2%		
Gain error thermal drift	TCE_G	-30	± 10	30	$\text{ppm}/^\circ\text{C}$	
Power supply rejection ratio	PSRR		-106		dB	PSRR vs AVDD, at DC
			-104		dB	PSRR vs AVDD, 100mV and 10kHz ripple
AC Accuracy						
Signal to noise ratio	SNR	78	82.5		dB	$f_{IN} = 1\text{kHz}$
Signal to noise and distortion	SINAD	77	82.5		dB	$f_{IN} = 1\text{kHz}$
Total harmonic distortion	THD		-96	-84	dB	$f_{IN} = 1\text{kHz}$
Spurious-free dynamic range	SFDR	86	100		dB	$f_{IN} = 1\text{kHz}$
Digital Input / Output						
Input current	I_{IN}	0		7	μA	$DGND \leq V_{IN} \leq DVDD$
Input capacitance	C_{IN}		5		pF	
Output load capacitance	C_{LOAD}		30		pF	
High-level input voltage	V_{IH}	$0.7 \times DVDD$		$DVDD + 0.3$	V	
Low-level input voltage	V_{IL}	-0.3		$0.3 \times DVDD$	V	
High-level output voltage	V_{OH}	$DVDD - 0.1$			V	$I_{OH} = -20\mu\text{A}$
		$DVDD - 0.4$			V	$I_{OH} = -4\text{mA}$
Low-level output voltage	V_{OL}			0.1	V	$I_{OL} = 20\mu\text{A}$
				0.4	V	$I_{OL} = 4\text{mA}$
Timing						
CLKIN clock frequency	f_{CLKIN}	5		21	MHz	
CLKIN clock period	t_{CLKIN}	47.6		200	ns	
CLKIN clock high time	t_{HIGH}	20	25	120	ns	
CLKIN clock low time	t_{LOW}	20	25	120	ns	
DOUT rising time	t_r			5	ns	$C_{LOAD} = 15\text{pF}$
DOUT falling time	t_f			5	ns	$C_{LOAD} = 15\text{pF}$
DOUT hold time after rising edge of CLKIN	t_H	3.5			ns	$C_{LOAD} = 15\text{pF}$
Rising edge of CLKIN to DOUT valid delay	t_D			15	ns	$C_{LOAD} = 15\text{pF}$

Parameters	Symbol	Min	Typ	Max	Unit	Comments
Analog setting time	t_{AS}		0.5		ms	AVDD step to 3.0 V with DVDD \geq 3.0 V, to DOUT valid, 0.1% settling

5.2. Electrical Characteristics: NSi1306M25

(AVDD = 3.0V ~ 5.5V, DVDD = 3.0V ~ 5.5V, INP = -250mV to +250mV, and INN = AGND = 0V, T_A = -40°C to 125°C and sinc³ filter with OSR=256. Unless otherwise noted, Typical values are at CLKIN=20MHz, AVDD = 5V, DVDD = 3.3V, T_A = 25°C)

Parameters	Symbol	Min	Typ	Max	Unit	Comments
Power Supply						
Analog Side Supply Voltage	AVDD	3.0	5.0	5.5	V	
Digital Side Supply Voltage	DVDD	3.0	3.3	5.5	V	
Analog Side Supply Current	IAVDD		11.4	15.1	mA	
Digital Side Supply Current	IDVDD		1.78	2.5	mA	
AVDD undervoltage detection threshold voltage	AVDD _{UV}	1.8	2.3	2.7	V	AVDD falling
Analog Input						
Common-mode overvoltage detection level	V_{CMov}	0.9			V	Detection level has a typical hysteresis of 96 mV
Common-mode rejection ratio	CMRR _{dc}		-106		dB	INP = INN, $f_{IN} = 0$ Hz, $V_{CM\ min} \leq V_{IN} \leq V_{CM\ max}$
	CMRR _{ac}		-104		dB	INP = INN, $f_{IN} = 10$ kHz, $V_{CM\ min} \leq V_{IN} \leq V_{CM\ max}$
Single-ended input resistance	R_{IN}		19		k Ω	INN = AGND
Differential input resistance	R_{IND}		22		k Ω	
Input capacitance	C_I		2		pF	
Input bias current	I_{IB}	-24	-18	-12	μ A	INP = INN = AGND, $I_{IB} = (I_{IBP} + I_{IBN}) / 2$
Input bias current drift	$T_{CI_{IB}}$		± 1		nA/°C	
Common-mode transient immunity	CMTI	100	150		kV/ μ s	Common-mode transient immunity
DC Accuracy						
Differential nonlinearity	DNL	-0.99		0.99	LSB	
Integral nonlinearity	INL	-4	± 1	4	LSB	
Offset error	E_O	-100	± 4.5	100	μ V	INP = INN = AGND
Offset error thermal drift	TCE_O	-0.5	± 0.15	1.5	μ V/°C	
Gain error	E_G	-0.2%	$\pm 0.005\%$	0.2%		

Parameters	Symbol	Min	Typ	Max	Unit	Comments
Gain error thermal drift	TCE _G	-40	±20	40	ppm/ °C	
Power supply rejection ratio	PSRR		-100		dB	PSRR vs AVDD, at DC
			-90		dB	PSRR vs AVDD, 100mV and 10kHz ripple
AC Accuracy						
Signal to noise ratio	SNR	82	86		dB	f _{IN} = 1kHz
Signal to noise and distortion	SINAD	82	86		dB	f _{IN} = 1kHz
Total harmonic distortion	THD		-95	-85	dB	f _{IN} = 1kHz
Spurious-free dynamic range	SFDR	83	100		dB	f _{IN} = 1kHz
Digital Input / Output						
Input current	I _{IN}	0		7	μA	DGND ≤ V _{IN} ≤ DVDD
Input capacitance	C _{IN}		5		pF	
Output load capacitance	C _{LOAD}		30		pF	
High-level input voltage	V _{IH}	0.7×DVDD		DVDD+0.3	V	
Low-level input voltage	V _{IL}	-0.3		0.3×DVDD	V	
High-level output voltage	V _{OH}	DVDD-0.1			V	I _{OH} = -20μA
		DVDD-0.4			V	I _{OH} = -4mA
Low-level output voltage	V _{OL}			0.1	V	I _{OL} = 20μA
				0.4	V	I _{OL} = 4mA
Timing						
CLKIN clock frequency	f _{CLKIN}	5		21	MHz	
CLKIN clock period	t _{CLKIN}	47.6		200	ns	
CLKIN clock high time	t _{HIGH}	20	25	120	ns	
CLKIN clock low time	t _{LOW}	20	25	120	ns	
DOUT rising time	t _r			5	ns	C _{LOAD} = 15pF
DOUT falling time	t _f			5	ns	C _{LOAD} = 15pF
DOUT hold time after rising edge of CLKIN	t _H	3.5			ns	C _{LOAD} = 15pF
Rising edge of CLKIN to DOUT valid delay	t _D			15	ns	C _{LOAD} = 15pF
Analog setting time	t _{AS}		0.5		ms	AVDD step to 3.0 V with DVDD ≥ 3.0 V, to DOUT valid, 0.1% settling

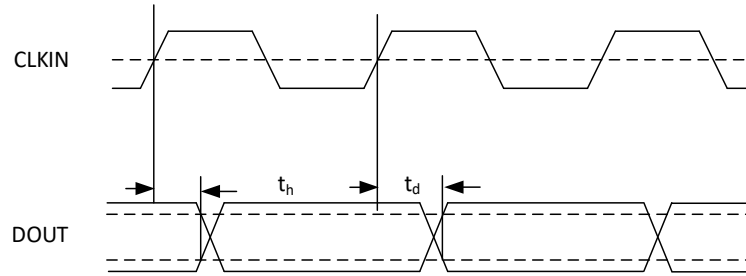

Figure 5.1 Digital Input and Output Timing

5.3. Typical Performance Characteristics

Unless otherwise noted, test at AVDD = 5V, DVDD = 3.3V, Vin = -250mV to 250mV (NSI1306M25) or -50mV to 50mV (NSI1306M05), CLKIN=20MHz, and sinc³ filter with OSR=256.

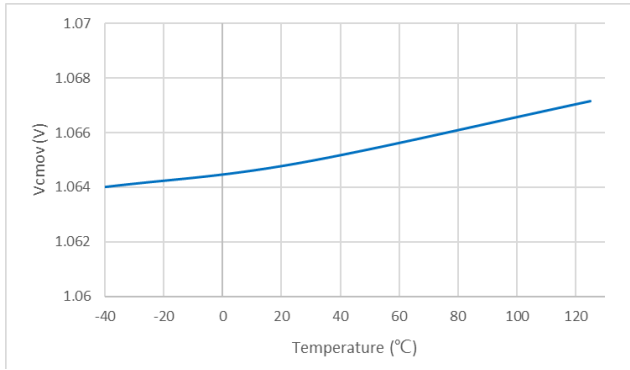

Figure 5.2 Common-Mode Overtolerance Level vs Temperature

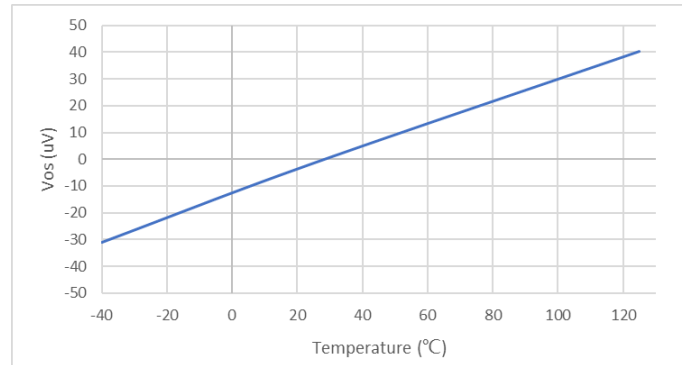

Figure 5.5 Input Offset Voltage vs Temperature

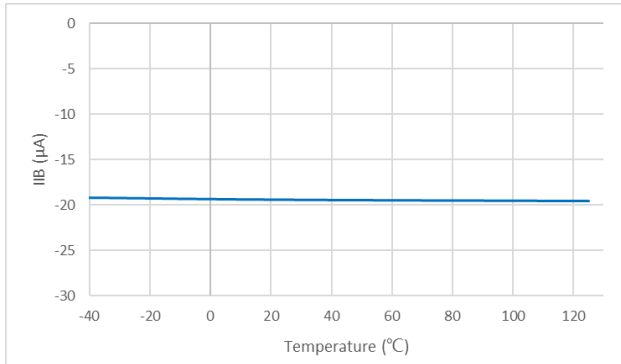

Figure 5.3 Input Bias Current vs Temperature

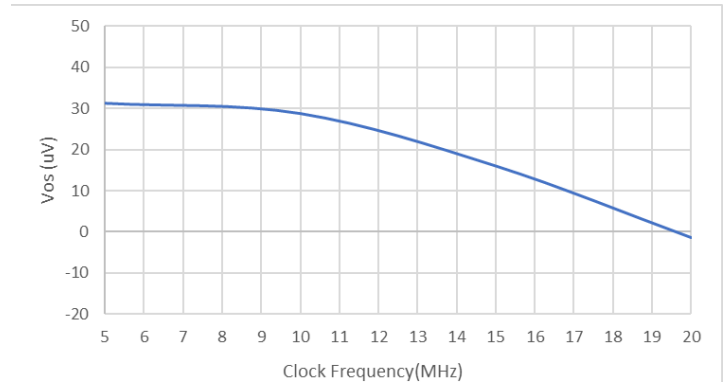

Figure 5.6 Input Offset Voltage vs Clock Frequency

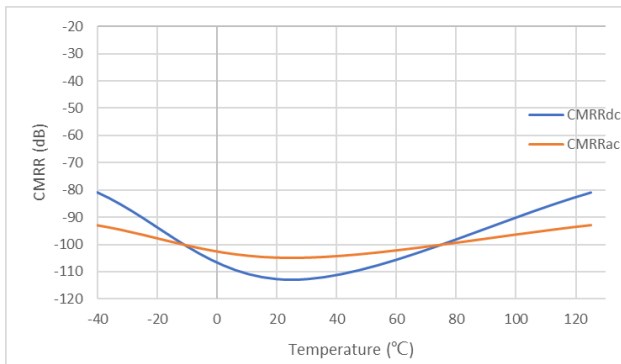

Figure 5.4 Common-Mode Rejection Ratio vs Temperature

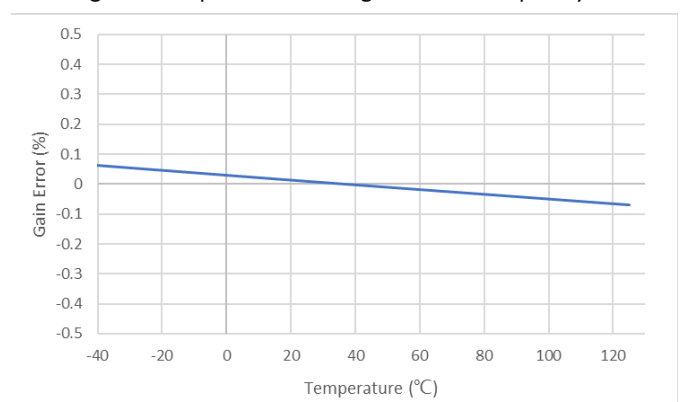

Figure 5.7 Gain Error vs Temperature

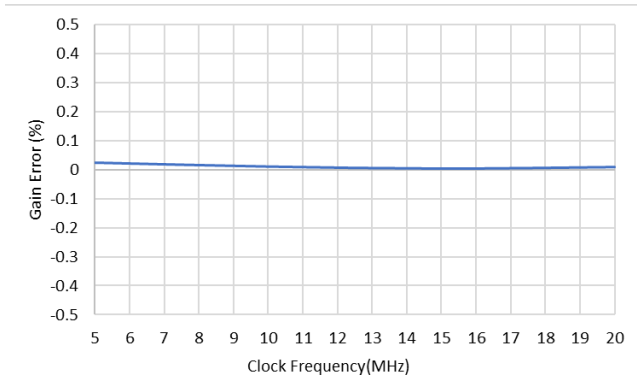

Figure 5.8 Gain Error vs Clock Frequency

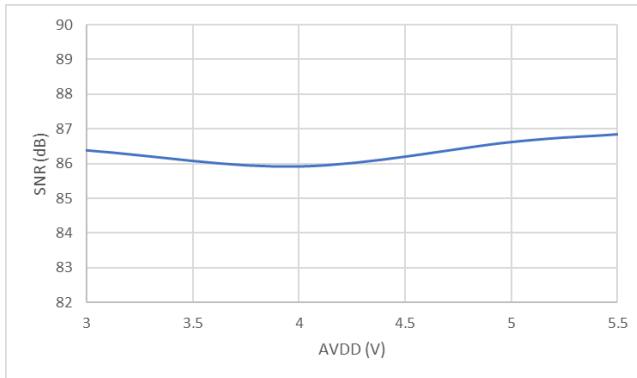

Figure 5.9 Signal-to-Noise Ratio vs Analog Side Supply Voltage

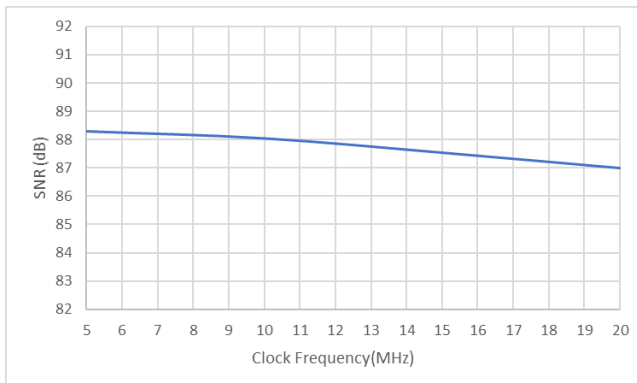

Figure 5.10 Signal-to-Noise Ratio vs Clock Frequency

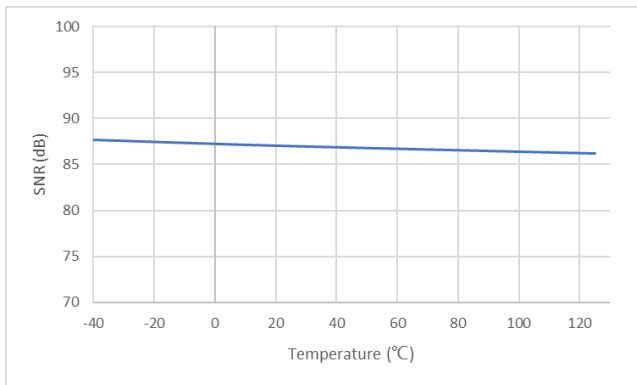

Figure 5.11 Signal-to-Noise Ratio vs Temperature

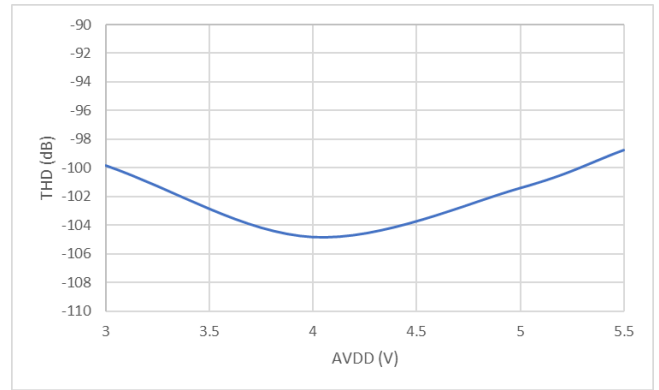

Figure 5.12 Total Harmonic Distortion vs Analog Side Supply Voltage

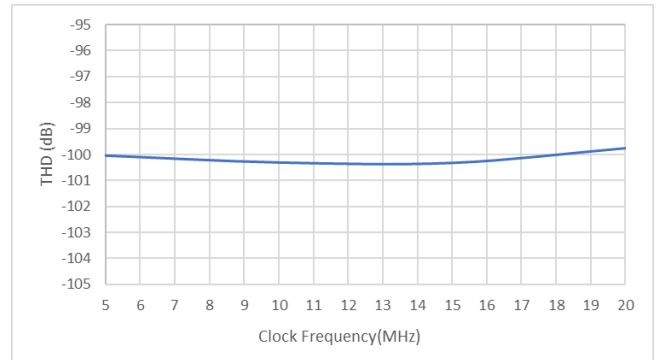

Figure 5.13 Total Harmonic Distortion vs Clock Frequency

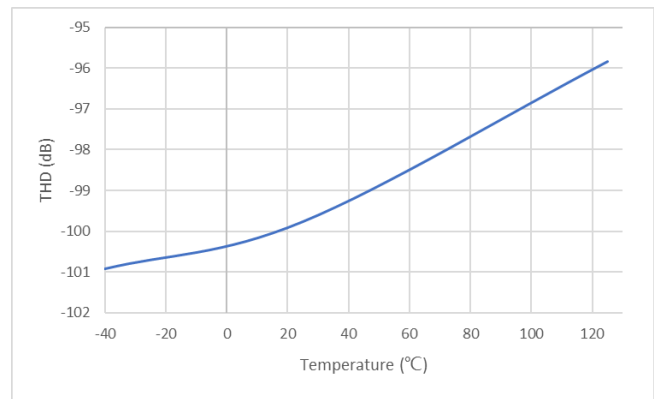

Figure 5.14 Total Harmonic Distortion vs Temperature

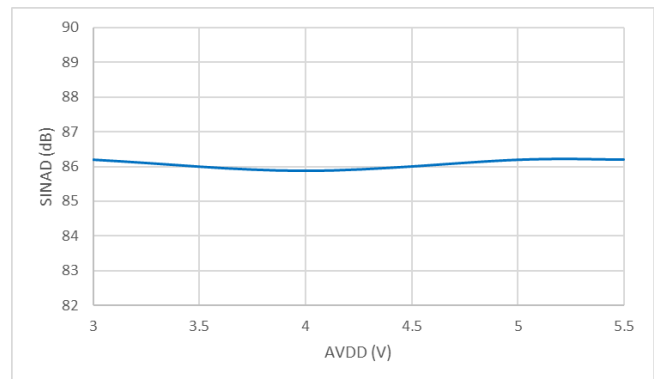

Figure 5.15 Signal-to-Noise + Distortion vs Analog Side Supply Voltage

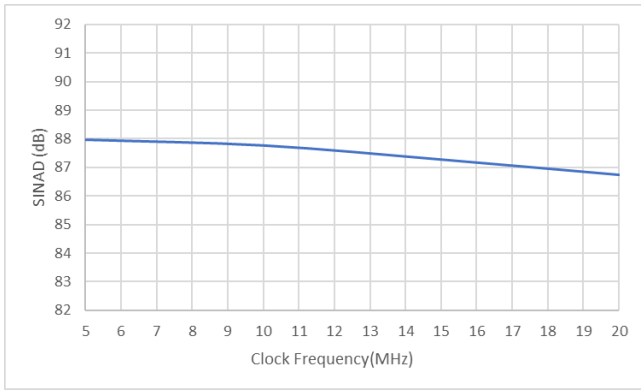

Figure 5.16 Signal-to-Noise + Distortion vs Clock Frequency

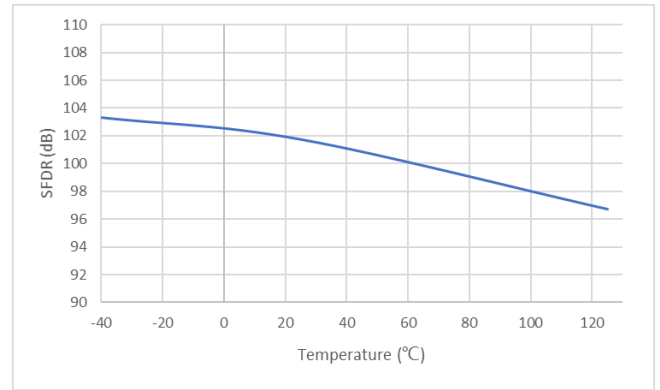

Figure 5.20 Spurious-Free Dynamic Range vs Temperature

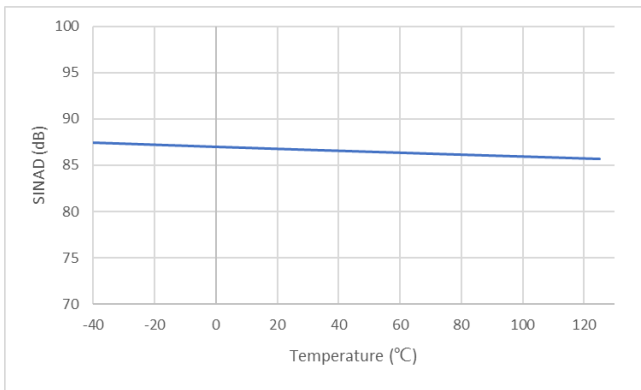

Figure 5.17 Signal-to-Noise + Distortion vs Temperature

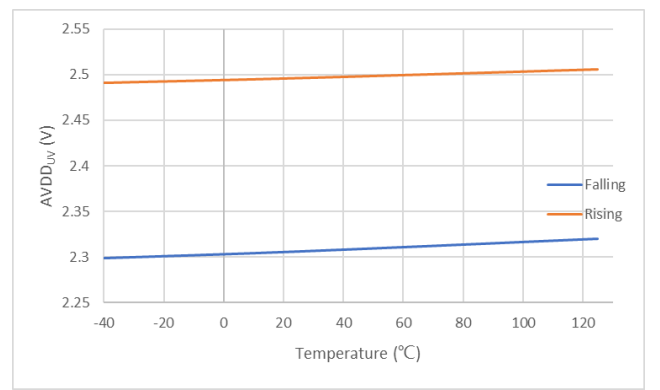

Figure 5.21 Analog Side Under-Voltage Detection Level vs Temperature

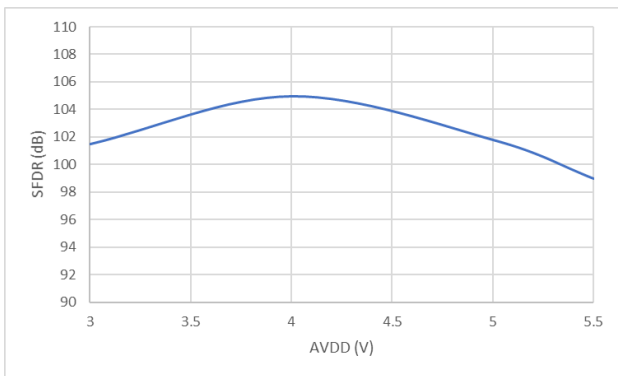

Figure 5.18 Spurious-Free Dynamic Range vs Analog Side Supply Voltage

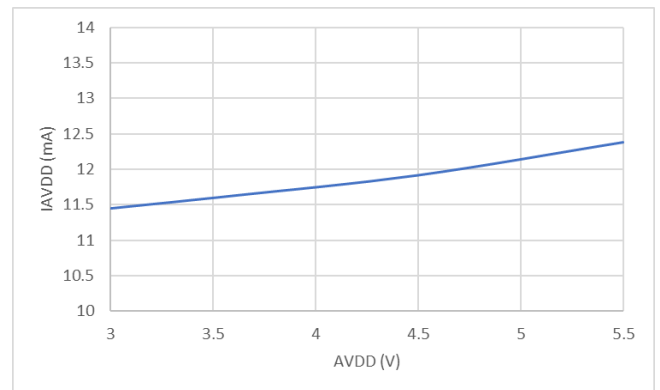

Figure 5.22 Analog Side Supply Current vs Supply Voltage

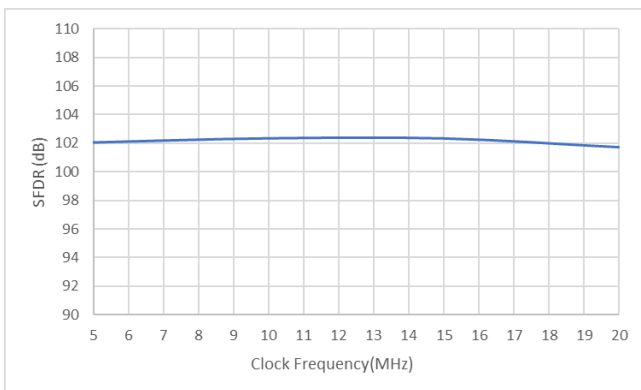

Figure 5.19 Spurious-Free Dynamic Range vs Clock Frequency

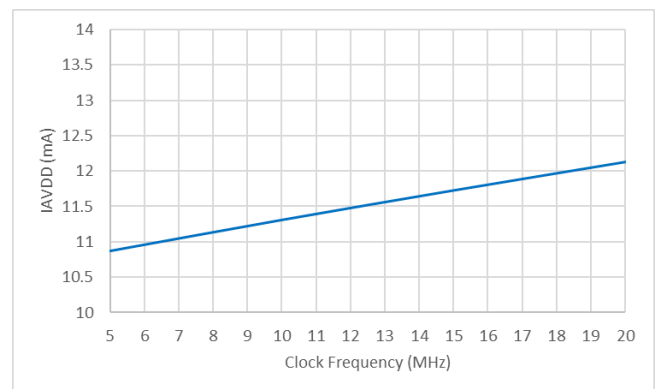

Figure 5.23 Analog Side Supply Current vs Clock Frequency

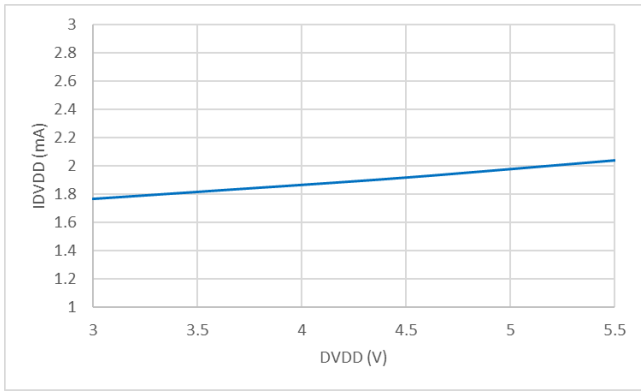

Figure 5.24 Digital Side Supply Current vs Supply Voltage

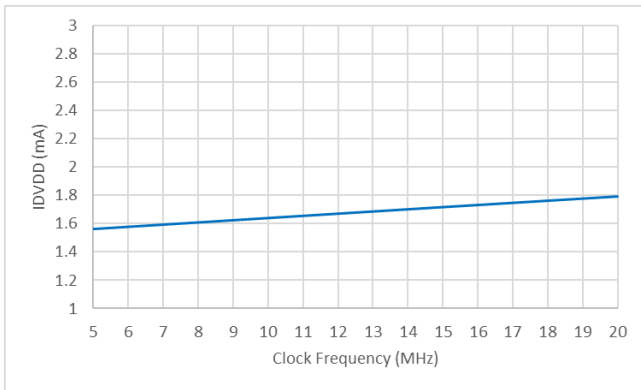

Figure 5.25 Digital Side Supply Current vs Clock Frequency

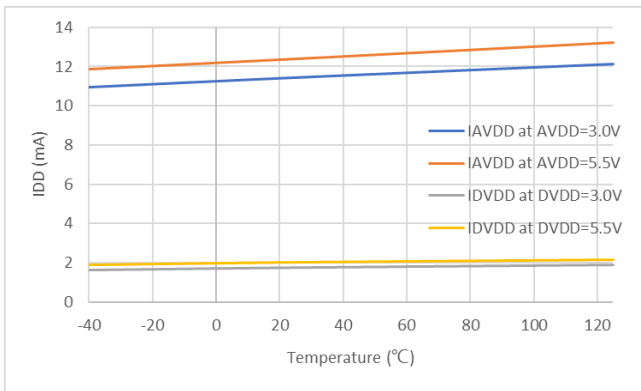

Figure 5.26 Supply Current vs Temperature

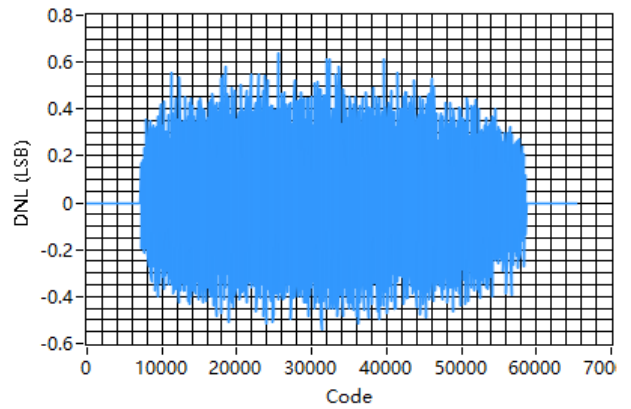

Figure 5.27 Typical Differential Nonlinearity

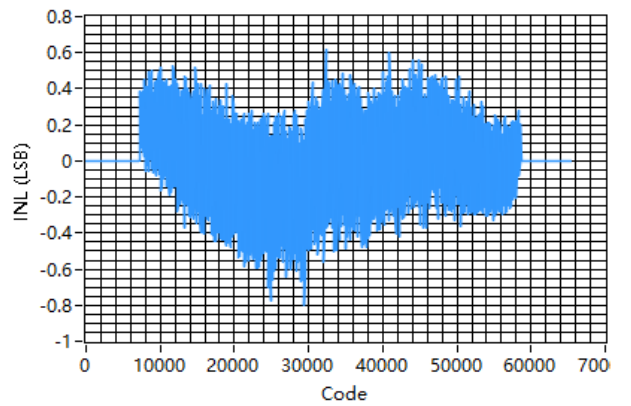

Figure 5.28 Typical Integral Nonlinearity

6. High Voltage Feature Description

6.1. Insulation and Safety Related Specifications

Parameters	Symbol	Value	Unit	Comments
Minimum External Air Gap (Clearance)	CLR	8	mm	Shortest terminal-to-terminal distance through air
Minimum External Tracking (Creepage)	CPG	8	mm	Shortest terminal-to-terminal distance across the package surface
Minimum internal gap	DTI	28	μm	Distance through insulation
Tracking Resistance (Comparative Tracking Index)	CTI	>600	V	DIN EN 60112 (VDE 0303-11); IEC 60112
Material Group		I		IEC 60664-1

6.2. Insulation Characteristics

Description	Test Condition	Symbol	Value	Unit	
DIN VDE 0110			SOW8	SOW16	
Installation Classification per DIN VDE 0110					
For Rated Mains Voltage ≤ 150Vrms			I to IV	I to IV	
For Rated Mains Voltage ≤ 300Vrms			I to IV	I to IV	
For Rated Mains Voltage ≤ 400Vrms			I to IV	I to IV	
Climatic Classification			40/125/21	40/125/21	
Pollution Degree per DIN VDE 0110, Table 1			2	2	
Maximum repetitive isolation voltage		V_{IORM}	2121	2121	V_{PEAK}
Maximum working isolation voltage	AC Voltage	V_{IOWM}	1500	1500	V_{RMS}
	DC Voltage		2121	2121	V_{DC}
Input to Output Test Voltage, Method B1	$V_{IORM} \times 1.875 = V_{pd(m)}$, 100% production test, $t_{ini} = t_m = 1$ sec, partial discharge < 5 pC	$V_{pd(m)}$	3977	3977	V_{PEAK}
Input to Output Test Voltage, Method A					
After Environmental Tests Subgroup 1	$V_{IORM} \times 1.6 = V_{pd(m)}$, $t_{ini} = 60$ sec, $t_m = 10$ sec, partial discharge < 5 pC	$V_{pd(m)}$	3394	3394	V_{PEAK}
After Input and /or Safety Test Subgroup 2 and Subgroup 3	$V_{IORM} \times 1.2 = V_{pd(m)}$, $t_{ini} = 60$ sec, $t_m = 10$ sec, partial discharge < 5 pC	$V_{pd(m)}$	2545	2545	V_{PEAK}
Maximum transient isolation voltage	$t = 60$ sec	V_{IOTM}	8000	8000	V_{PEAK}

Description	Test Condition	Symbol	Value	Value	Unit
Maximum Surge Isolation Voltage	Test method per IEC60065,1.2/50us waveform, $V_{TEST}=V_{IOSM} \times 1.6$	V_{IOSM}	6250	6250	V_{PEAK}
Isolation resistance	$V_{IO} = 500V, T_{amb}=T_s$	R_{IO}	$>10^9$	$>10^9$	Ω
	$V_{IO} = 500V, 100^\circ C \leq T_{amb} \leq 125^\circ C$	R_{IO}	$>10^{11}$	$>10^{11}$	Ω
Isolation capacitance	$f = 1MHz$	C_{IO}	0.8	0.8	pF
Safety input, output, or total power	$V_I = 5.5V, T_J = 150^\circ C, T_A = 25^\circ C$	P_S	1430	1524	mW
Safety input, output, or supply current	$\theta_{JA} = 86^\circ C/W$ for SOP8, $V_I = 5.5V, T_J = 150^\circ C, T_A = 25^\circ C$	I_S	260	/	mA
	$\theta_{JA} = 82^\circ C/W$ for SOP16, $V_I = 5.5V, T_J = 150^\circ C, T_A = 25^\circ C$		/	277	mA
Maximum safety temperature		T_s	150	150	$^\circ C$
UL1577					
Insulation voltage per UL	$V_{TEST} = V_{ISO}, t = 60 s$ (qualification), $V_{TEST} = 1.2 \times V_{ISO}, t = 1 s$ (100% production test)	V_{ISO}	5000	5000	V_{RMS}

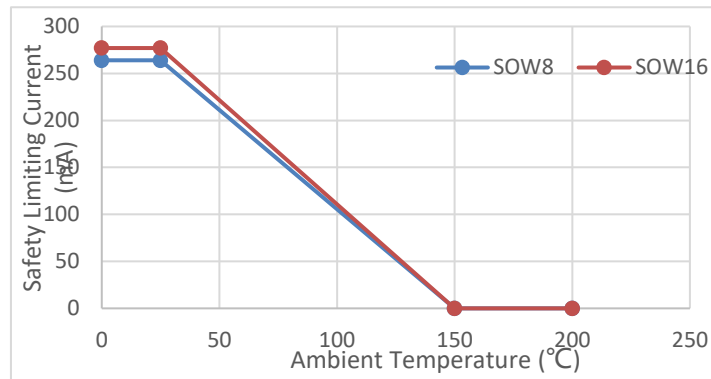

Figure 6.1 NSi1306 Thermal Derating Curve, Dependence of Safety Limiting Values with Case Temperature per DIN VDE V 0884-11

6.3. Regulatory Information

The NSi1306 are approved or pending approval by the organizations listed in table.

UL	VDE	CQC
UL 1577 Component Recognition Program	Approved under CSA Component Acceptance Notice 5A	DIN VDE V 0884-11(VDE V 0884-11):2017-01
Single Protection, 5000V _{rms} Isolation voltage	Certified by CQC11-471543-2012 GB4943.1-2011	Reinforce Insulation 2121V _{peak} , $V_{IOSM}=6250V_{peak}$
Certificate No.E500602	Single Protection, 5000V _{rms} Isolation voltage	Reinforced insulation
Certificate No.E500602	Certificate No.E500602	Certificate No.40052820
		CQC20001264939

7. Function Description

7.1. Overview

The NSI1306 is a high performance isolated modulator that accept fully-differential input. The fully-differential input is ideally suited to shunt current monitoring in high voltage applications where isolation is required. The analog input is continuously sampled by a second-order Σ - Δ modulator in the device, which is driven by a pre-stage fully-differential amplifier in the device. With the internal voltage reference and clock generator, the modulator convert the analog input signal to a digital bitstream. The drivers (called TX in the Functional Block Diagram) transfer the output of the modulator across the isolation barrier that separate external clock, as shown in the Functional Block Diagram.

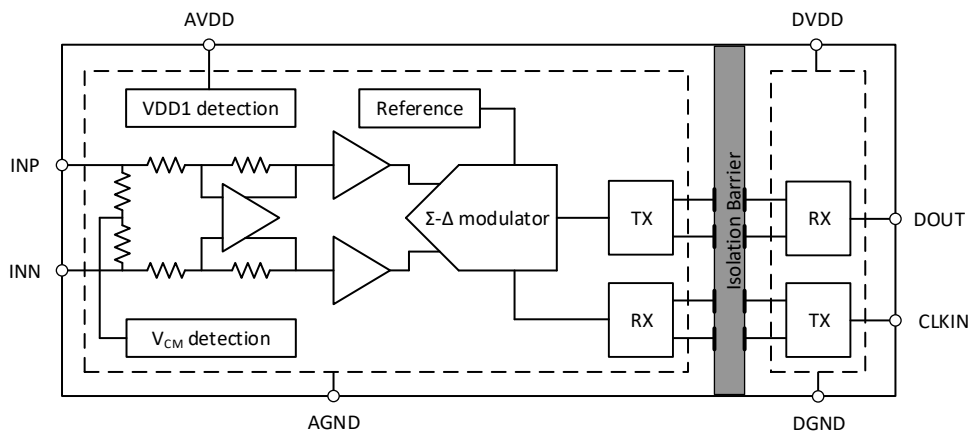

Figure 7.1 Function Block Diagram

7.2. Analog Input

There are two restrictions on the analog input signals (VINP and VINN).

- If the input voltage exceeds the range AGND – 6 V to AVDD + 0.5 V, the input current must be limited to 10 mA because the device input electrostatic discharge (ESD) diodes turn on.
- The linearity and noise performance of the device are ensured only when the analog input voltage remains within the specified linear full-scale range (FSR) and within the specified common-mode input voltage range.

7.3. Digital Input

The digital input refers to clock signal which provides the clock for modulator conversion and output data frame clock. The clock signal should be supplied by an external source with a frequency range from 5MHz to 21MHz.

7.4. Digital Output

The digital output provides a stream of ones and zeros that can accurately represents the analog input voltage. Within the linear input range, the density of ones in the bitstream is proportional to the input voltage.

Ideally for a 0V input signal, the modulator outputs a bitstream with 50% high time. For a 250mV input signal (for the NSI1306M25), the modulator outputs a bitstream with 89.06% high time. For a -250mV input signal (for the NSI1306M25), the modulator outputs a bitstream with 10.94% high time.

If the input signal is greater than or equal to 320mV (64 mV for the NSI1306x05), the modulator clips with a steam of all ones. If the input signal is less than or equal to -320mV (-64 mV for the NSI1306x05), the output of the modulator clips with a stream of all zeros. In this case, however, the NSI1306 generates a single 0 (if the input is at positive full-scale) or 1 every 128 clock cycles to indicate proper device function (see section 7.5 for more details).

Due to quantization noise of internal Σ - Δ modulator, the digital output frequency is not fixed, but the density of high time is fixed based on input voltage. Typical modulator digital output characteristics are as below.

Table 7.1 Input voltage with ideal corresponding density of high time at modulator data output, and ADC code

Analog input	Input voltage	Density of high time	Digital output code(16-bit unsigned decimation)
+Differential input voltage before	+320mV	99.22%	65024

clipping output	(+64mV for NSI1306x05)		
+Linear differential input full scale voltage	+250mV (+50mV for NSI1306x05)	89.06%	58366
Zero	0mV	50%	32768

Ideal density of 1s in the output bitstream for any input voltage(except for full-scale input, as described in section 7.5) at modulator data output can be calculated with:

$$\frac{V_{IN} + V_{CLIPPING}}{2 \times V_{CLIPPING}}$$

Similarly, the ADC code can be calculated, assuming a 16-bit unsigned decimation filter.

7.5. Fail-safe Output

NSI1306 integrates some diagnostic measures and offers a fail-safe output to simplify system-level design. The fail-safe function will be activated in following conditions:

- When the undervoltage of AVDD is detected ($AVDD < AVDD_{UV}$), DOUT pin output a bitstream of all logic zeros, as shown in Figure 7.2.
- When the overvoltage of common-mode input voltage is detected ($V_{CM} > V_{CMov}$), DOUT pin output a bitstream of all logic ones, as shown in Figure 7.2.

NOTE: If both of the faults above occur at the same time, DOUT pin output a bitstream of all logic zeros. (AVDD missing has a higher priority).

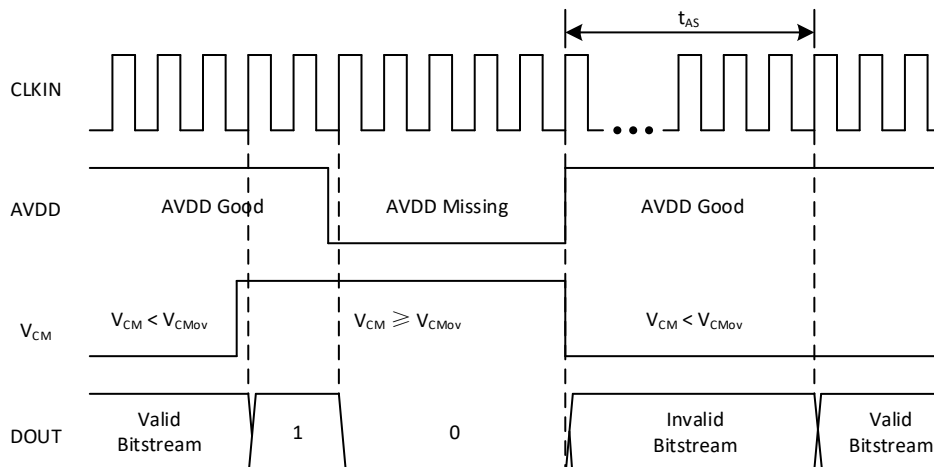

Figure 7.2 Fail-safe output

If an overrange input signal is applied to the NSI1306 ($V_{IN} \geq V_{CLIPPING}$), the output generates a single 0 or 1 every 128 clock cycles, as shown in Figure 7.3.

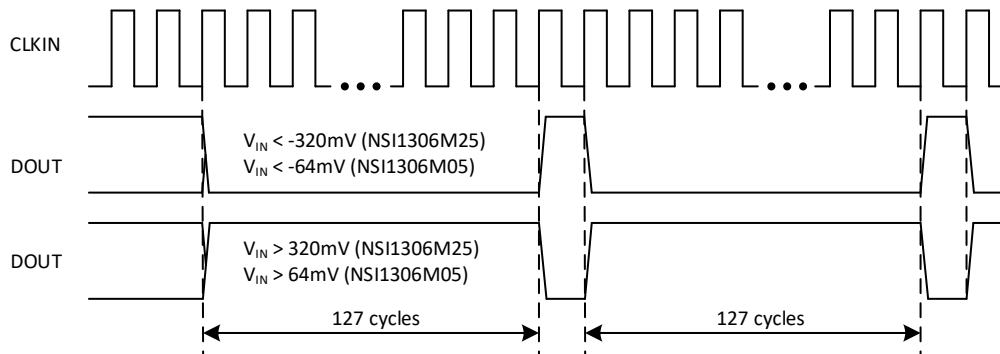

Figure 7.3 Overrange output

8. Application Note

8.1. Typical Application Circuit

NSi1306 is ideally suited to shunt resistor-based current sensing in high voltage applications such as frequency inverters. The typical application circuit is shown in Figure 8.1.

The voltage across the shunt resistor R_{sense} is applied to the differential input of NSi1306 through a RC filter. The internal second-order sigma-delta modulator converts the analog input to a single-bit output stream. The external digital system provides a clock source for the modulator and a digital filter for decimation and quantization noise filtering.

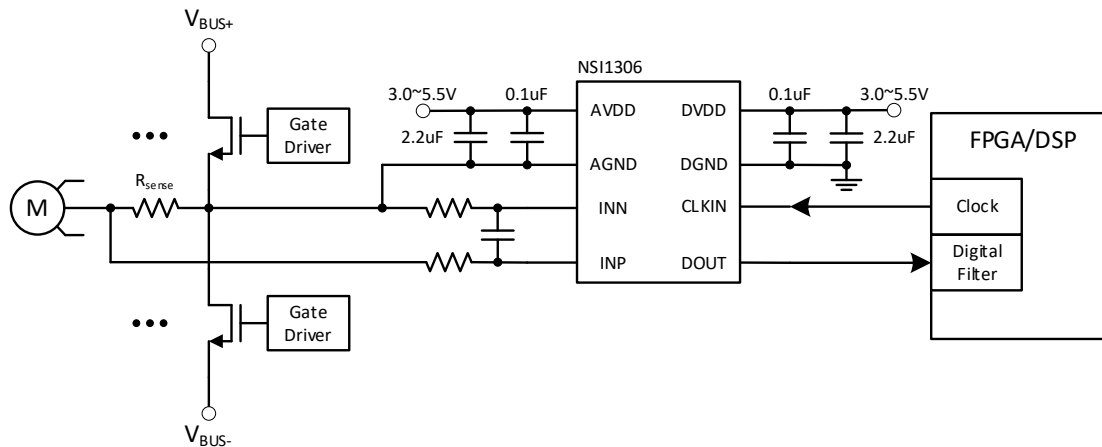

Figure 8.1 Typical application circuit in phase current sensing

8.2. Shunt Resistor Selection

Choosing a particular shunt resistor is usually a compromise between minimizing power dissipation and maximizing accuracy. Smaller sense resistor decreases power dissipation, while larger sense resistor can improve measure accuracy by utilizing the full input range of isolated amplifier.

There are two other factors should be considered when selecting the shunt resistor:

- The voltage-drop caused by the rated current range must not exceed the recommended linear input voltage range: $V_{SHUNT} \leq FSR$.
- The voltage-drop caused by the maximum allowed overcurrent must not exceed the input voltage that causes a clipping output: $V_{SHUNT} \leq V_{clipping}$.

8.3. Digital Filter

The Σ - Δ modulator a characteristics of noise shaping. Most of the quantization noise is pushed from a low frequency to a higher frequency.

In order to reduce higher-frequency quantization noise, the modulator output is fed to the digital low-pass filter. Subsequently, the signal of interest passes through to the output of the digital filter, while much of the higher-frequency quantization noise is filtered out.

The digital filter serves another function – decimation. It creates a digital output code from the bitstream that the modulator outputs. The ratio of the modulator rate (f_{MOD}) of the delta-sigma modulator to its output data rate (f_{DR}) is the oversampling ratio (OSR). The relationship between f_{DR} and f_{MOD} is:

$$f_{DR} = f_{MOD} / OSR \quad \text{Equation 8.1}$$

A sinc3 filter is recommended since it's simple and requires less hardware resources. Equation 8.2 describes the transfer function of a sinc filter.

$$H(Z) = \left(\frac{1}{DR} \frac{(1-Z^{-DR})}{(1-Z^{-1})} \right)^N \quad \text{Equation 8.2}$$

where:

DR is the decimation rate;

N is the sinc filter order.

The filter can be implemented in an FPGA or DSP. The sinc filter creates a digital output code by taking a multi-order moving average of the modulator output over a certain number of modulator clock periods.

The higher the decimation rate, the higher the conversion accuracy, and the lower the output data rate. So, there is a trade-off between accuracy and data rate. All the characterization in this datasheet is tested with a sinc3 filter with an oversampling ratio (OSR) of 256.

The output data size is expressed in Equation 8.3. The 16 most significant bits are used to return a 16-bit result.

$$\text{Data Size} = N \times \log_2 DR \quad \text{Equation 8.3}$$

The filter characteristics for a third-order sinc filter are summarized in Table 8.2.

Table 8.2 Sinc3 Filter Characteristics for 20 MHz CLKIN

Decimation Rate (DR)	Data Output Rate (kHz)	Data Size (bits)	Filter Response (kHz)
32	625	15	163.7
64	312.5	18	81.8
128	156.2	21	40.9
256	78.1	24	20.4
512	39.1	27	10.2

8.4. PCB Layout

There are some key guidelines or considerations for optimizing performance in PCB layout:

- NSI1306 requires a 0.1μF bypass capacitor between AVDD and AGND, DVDD and DGND. The capacitor should be placed as close as possible to the VDD pin. If better filtering is required, an additional 1~10μF capacitor may be used.
- Kelvin rules is recommended for the connection between shunt resistor to NSI1306. Because of the Kelvin connection, any voltage drops across the trace and leads should have no impact on the measured voltage.
- Place the shunt resistor close to the INP and INN inputs and keep the layout of both connections symmetrical and run very close to each other to the input of the NSI1306. This minimizes the loop area of the connection and reduces the possibility of stray magnetic fields from interfering with the measured signal.

9. Package Information

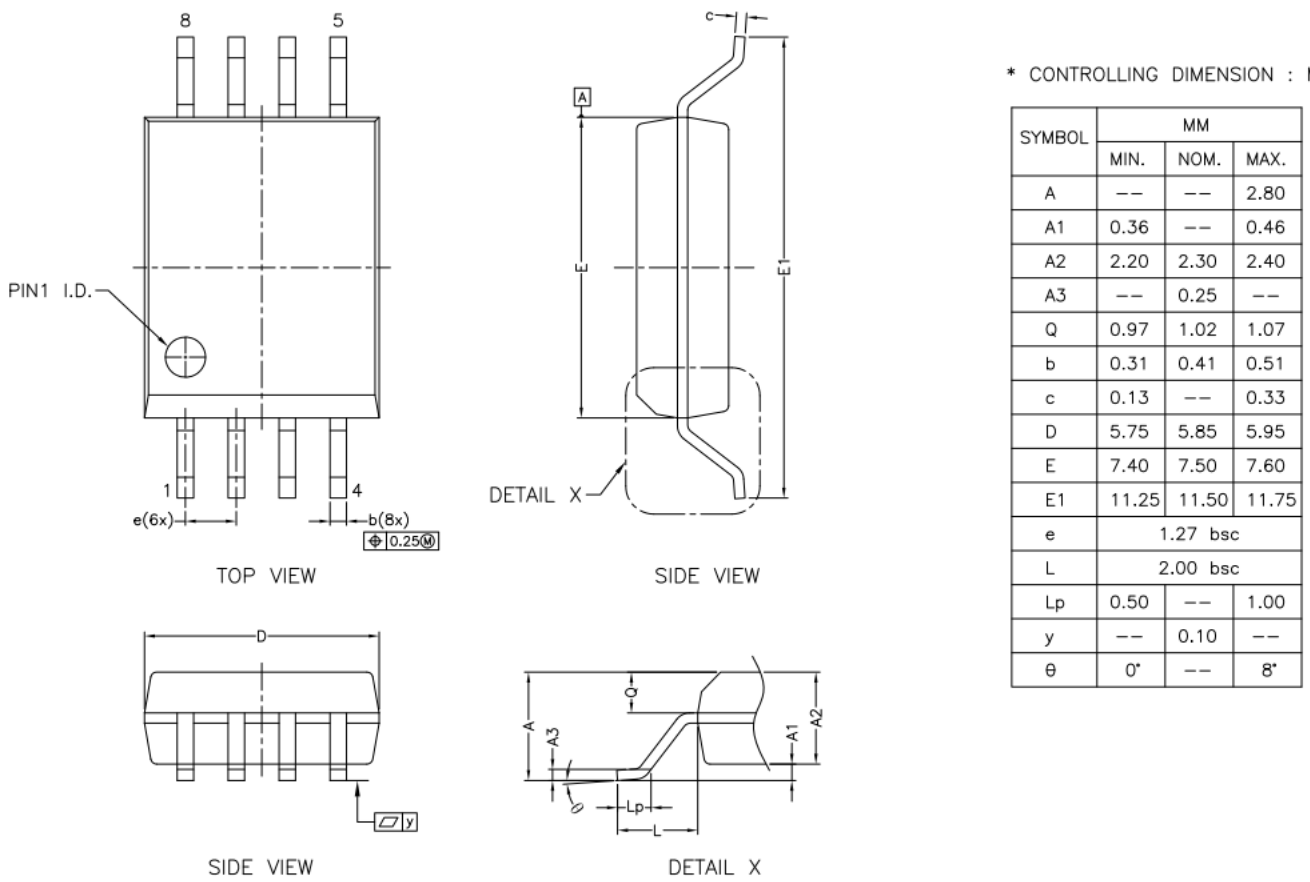
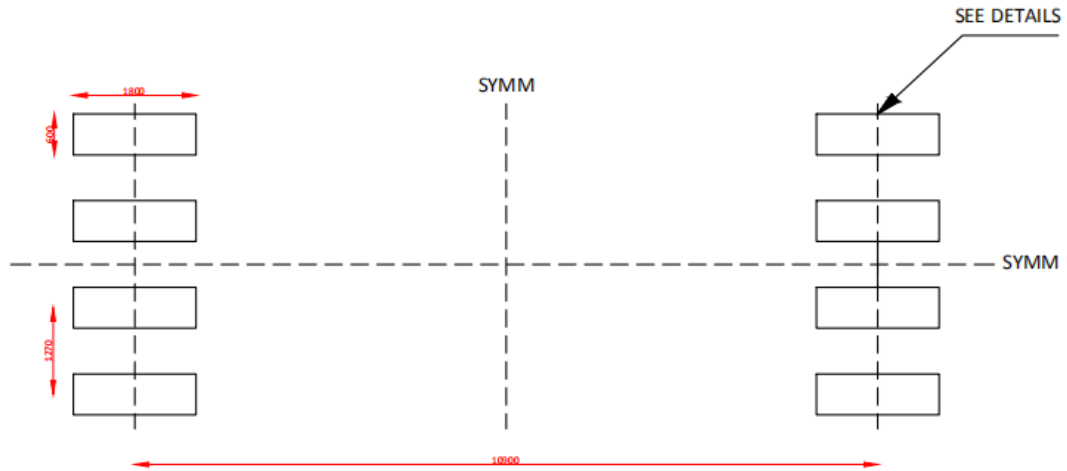

Figure 9.1 SOW8 Package Shape and Dimension in millimeters



LAND PATTERN EXAMPLE(um)

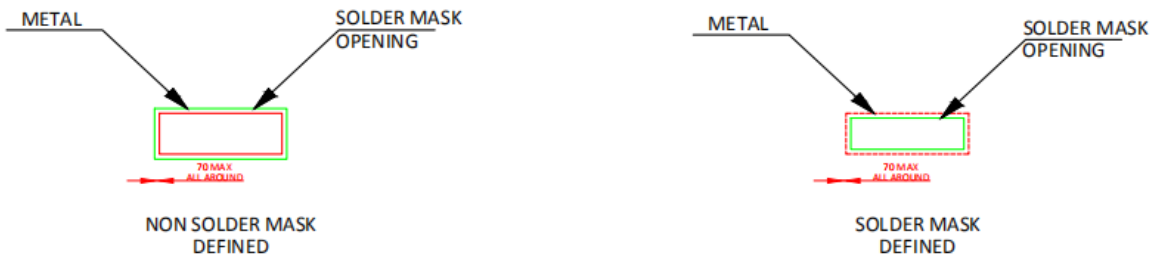

Figure 9.2 SOW8 Package Board Layout Example

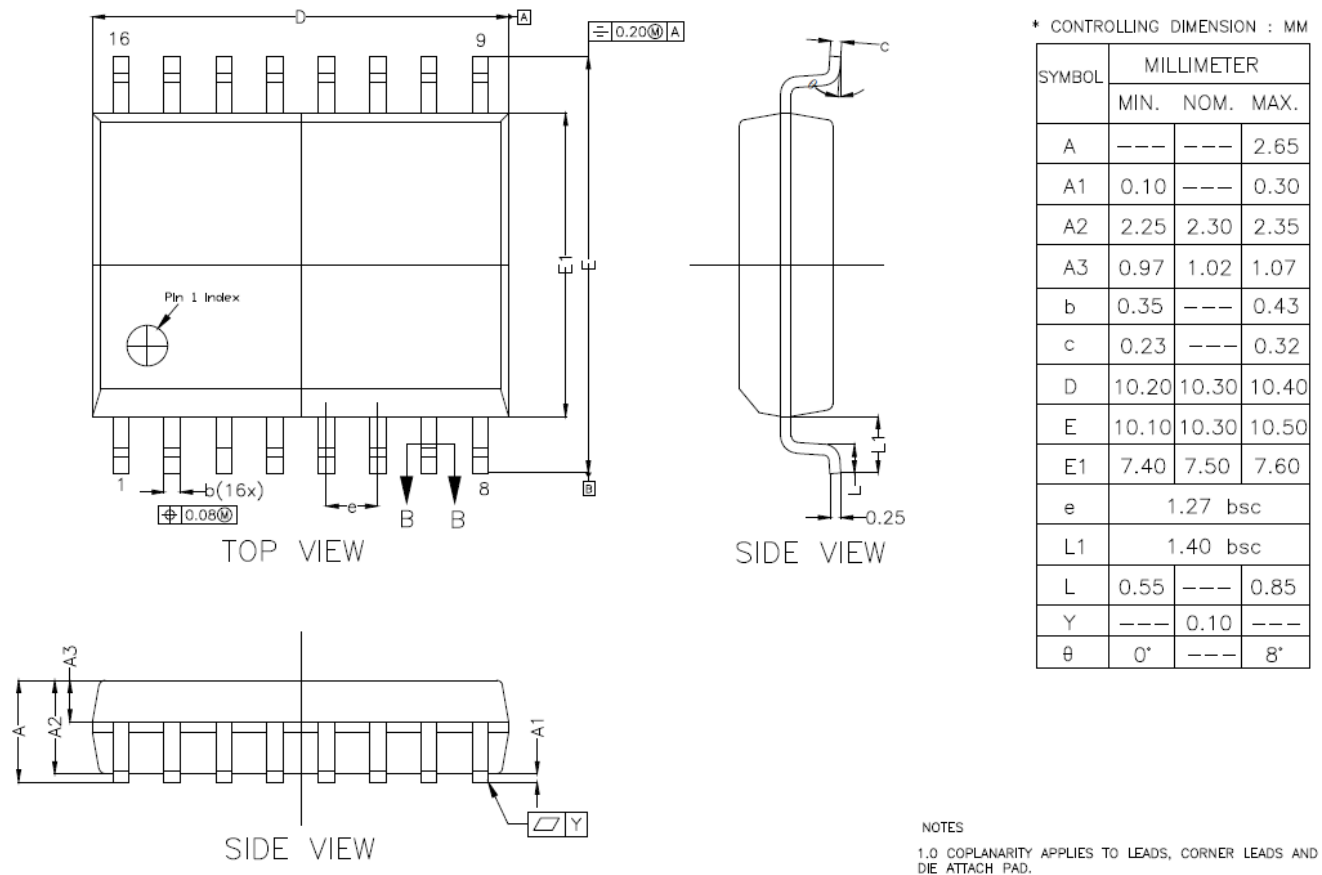

Figure 9.3 SOW16 package shape and dimension in millimeters

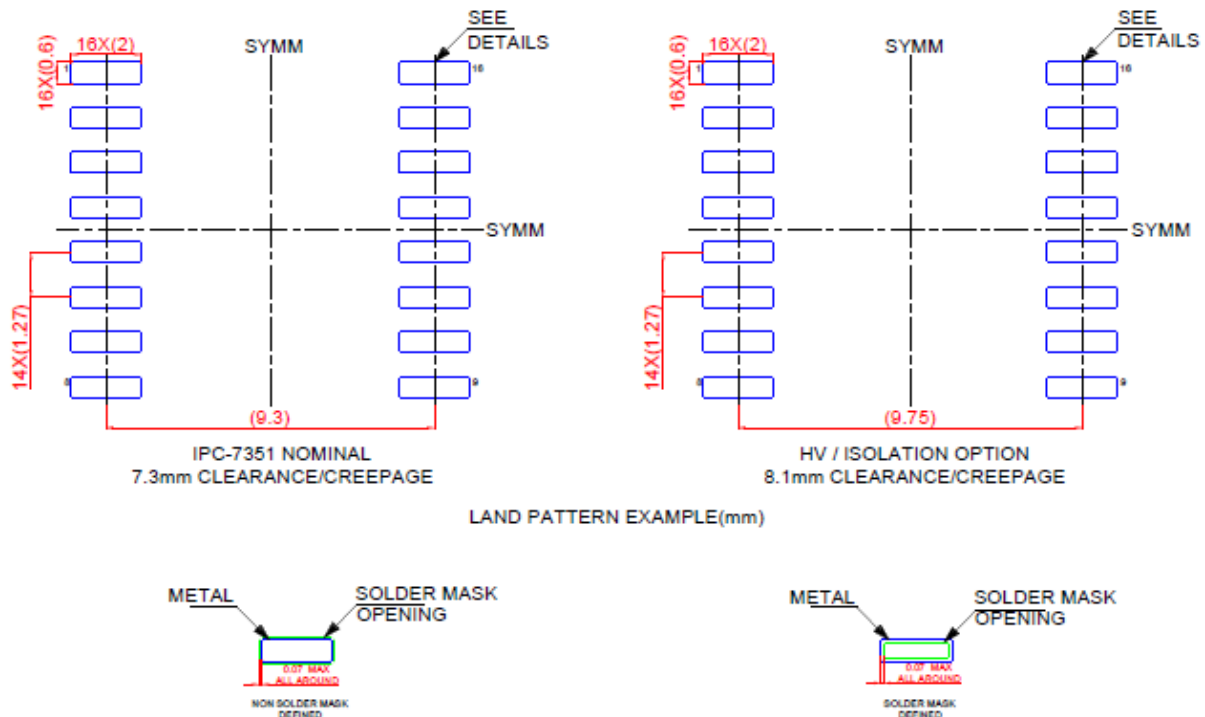

Figure 9.4 SOW16 Package Board Layout Example

10. Ordering Information

<i>Part No.</i>	<i>Isolation Rating(kV)</i>	<i>Linear Input Range(mV)</i>	<i>Moisture Sensitivity Level</i>	<i>Temperature</i>	<i>Automotive</i>	<i>Package Type</i>	<i>Package Drawing</i>	<i>SPQ</i>
NSI1306M05-DSWVR	5	-50 ~ 50	Level-3	-40 to 125°C	NO	SOP8 (300mil)	SOW8	1000
NSI1306M25-DSWVR	5	-250 ~ 250	Level-3	-40 to 125°C	NO	SOP8 (300mil)	SOW8	1000
NSI1306M05-DSWR	5	-50 ~ 50	Level-2	-40 to 125°C	NO	SOP16 (300mil)	SOW16	1000
NSI1306M25-DSWR	5	-250 ~ 250	Level-2	-40 to 125°C	NO	SOP16 (300mil)	SOW16	1000
NSI1306M05-Q1SWVR	5	-50 ~ 50	Level-3	-40 to 125°C	Yes	SOP8 (300mil)	SOW8	1000
NSI1306M25-Q1SWVR	5	-250 ~ 250	Level-3	-40 to 125°C	Yes	SOP8 (300mil)	SOW8	1000
NSI1306M05-Q1SWR	5	-50 ~ 50	Level-2	-40 to 125°C	Yes	SOP16 (300mil)	SOW16	1000
NSI1306M25-Q1SWR	5	-250 ~ 250	Level-2	-40 to 125°C	Yes	SOP16 (300mil)	SOW16	1000

11. Documentation Support

<i>Part Number</i>	<i>Product Folder</i>	<i>Datasheet</i>	<i>Technical Documents</i>	<i>Isolator selection guide</i>
NSi1306	Click here	Click here	Click here	Click here

12. Tape and Reel Information

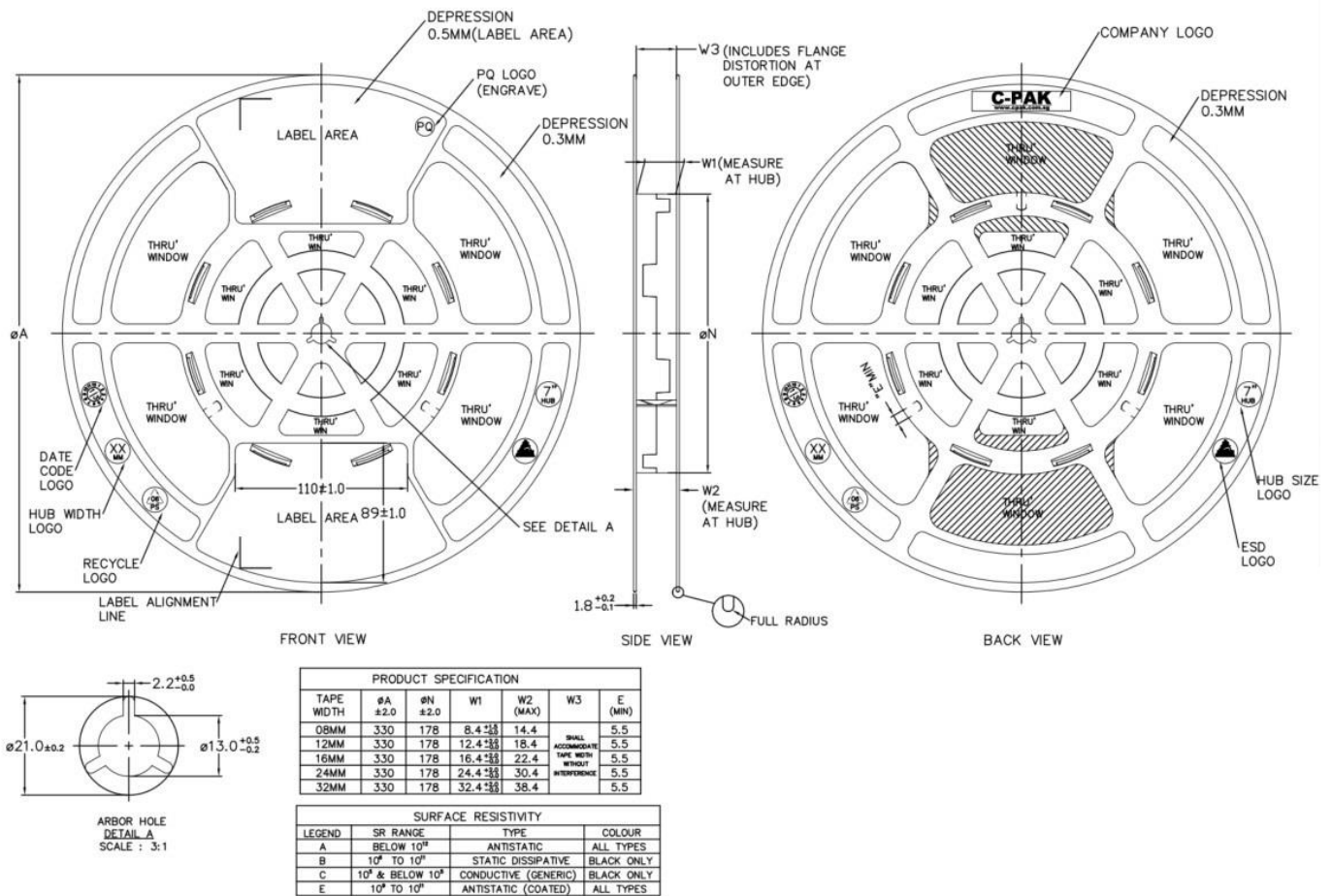
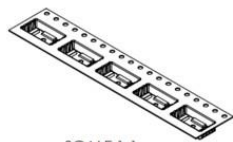
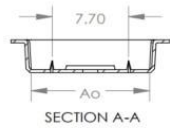
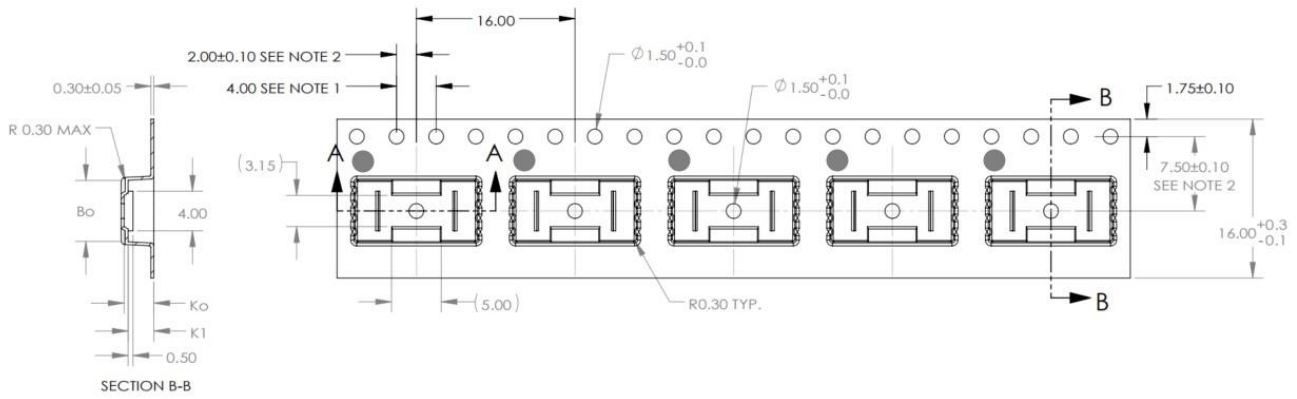

Figure 12.1 Tape Information



SCALE 1:1

DIM	±
Ao	11.95 0.10
Bo	6.15 0.10
Ko	3.00 0.10
K1	2.60 0.10

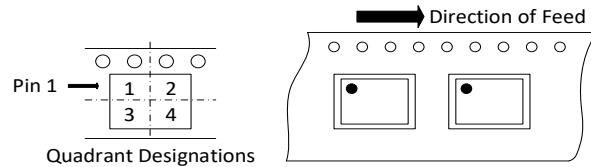
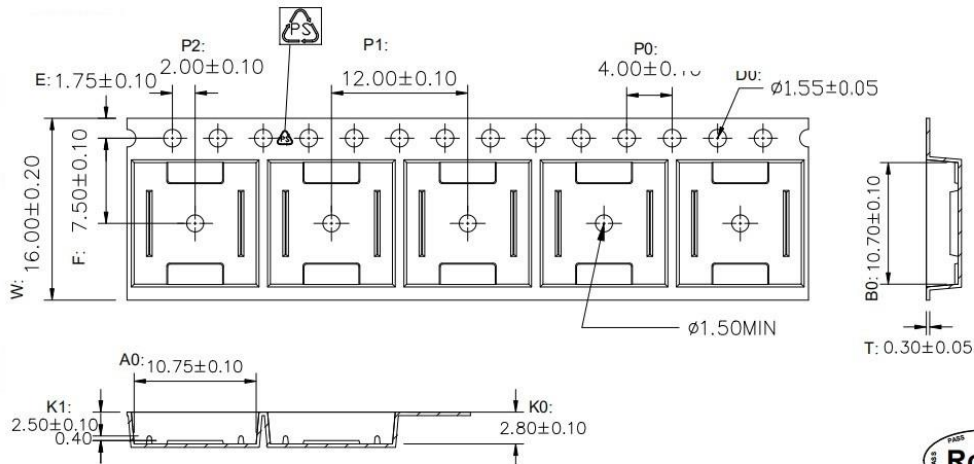

Figure 12.2 Reel Information of SOP8(300mil)



- 10 sprocket hole pitch cumulative tolerance ± 0.20 .
- Carrier camber is within 1 mm in 250 mm.
- Material : Black Conductive Polystyrene Alloy .
- All dimensions meet EIA-481 requirements.
- Thickness : 0.30 ± 0.05 mm.
- Packing length per 22" reel : 378 Meters.(復巻 N=122)
- Component load per 13" reel : 1000 pcs.
- Surface resistivity : $10^3 \sim 10^{10} \Omega/\square$



W	16.00±0.20
A0	10.75±0.10
B0	10.70±0.10
K0	2.80±0.10
K1	2.50±0.10

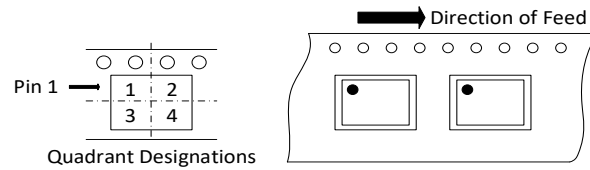

Figure 12.3 Reel Information of SOP16(300mil)

13. Revision History

Revision	Description	Date
1.0	Initial Release	2020/8/29
1.1	Update VDE Certificate number in 6.3, tape and reel information, and typical application circuit in 8.1	2020/12/28
1.2	Update moisture sensitivity level of NSi1306M05/25 -DSWR Update NSi1306M05 electrical characteristics, add V_{IH} and V_{IL} spec	2021/6/9
1.3	Update description in 7.1 , add SOW8 and SOW16 package layout example	2021/7/8
1.4	Update insulation information in 6.1 and 6.2	2021/7/17
1.5	Update pin 4 description of NSi1306-DSWR in Figure and table 1.2	2021/9/14
1.6	<ol style="list-style-type: none"> 1. Update reel information of SOP16 in Figure 12.3 2. Update DTI in 6.1 3. Add digital output description in 7.4 4. Add digital input and output timing in Figure 5.1 	2022/5/19

IMPORTANT NOTICE

The information given in this document shall in no event be regarded as any warranty or authorization of, express or implied, including but not limited to accuracy, completeness, merchantability, fitness for a particular purpose or infringement of any third party's intellectual property rights.

You are solely responsible for your use of Novosense' products and applications, and for the safety thereof. You shall comply with all laws, regulations and requirements related to Novosense's products and applications, although information or support related to any application may still be provided by Novosense.

The resources are intended only for skilled developers designing with Novosense' products. Novosense reserves the rights to make corrections, modifications, enhancements, improvements or other changes to the products and services provided. Novosense authorizes you to use these resources exclusively for the development of relevant applications designed to integrate Novosense's products. Using these resources for any other purpose, or any unauthorized reproduction or display of these resources is strictly prohibited. Novosense shall not be liable for any claims, damages, costs, losses or liabilities arising out of the use of these resources.

For further information on applications, products and technologies, please contact Novosense (www.novosns.com).

Suzhou Novosense Microelectronics Co., Ltd