



Data Sheet

NT52001

960/864/816/800 Outputs TFT-LCD Gate Driver

V0.0

Index

REVISION HISTORY	3
FEATURES	4
GENERAL DESCRIPTIONS	4
PIN ASSIGNMENT	5
BLOCK DIAGRAM	6
PIN DESCRIPTIONS	7
FUNCTIONAL DESCRIPTIONS	9
ABSOLUTE MAXIMUM RATINGS	11
DC ELECTRICAL CHARACTERISTICS	11
AC ELECTRICAL CHARACTERISTICS	12
TIMING WAVEFORMS	13
CHIP OUTLINE DIMENSIONS	15
BONDING DIAGRAM	16

NOVATEK CONFIDENTIAL
NO DISCLOSURE

Revision History

NT52001 Specification Revision History		
Version	Content	Date
0.0	Original	2008/10/28

NOVATEK CONFIDENTIAL
NO DISCLOSURE

Features

- Gate driver for TFT-LCD panels
- 960/864/816/800 channel outputs and 2 channel outputs which are fixed to VEE
- Bi-directional shift function
- Driving voltage range: 40V
- Logical supply voltage: 2.3 ~ 3.6V
- Cascade dot-expansion function
- CMOS silicon gate (P-type)
- COG solution
- Chip size=22660um*740um、Output bump pitch=22um

General Descriptions

NT52001 is a dedicated gate driver IC for TFT-LCD panels. After a start pulse is triggered, channel outputs pins will sequentially output high-driving voltage pulses as the gate signals on TFT-LCD panels. NT52001 also provides shift up/down selection and cascade functions for dot expansion. The special pin location is designed for COG type.

NOVATEK CONFIDENTIAL
NO DISCLOSURE

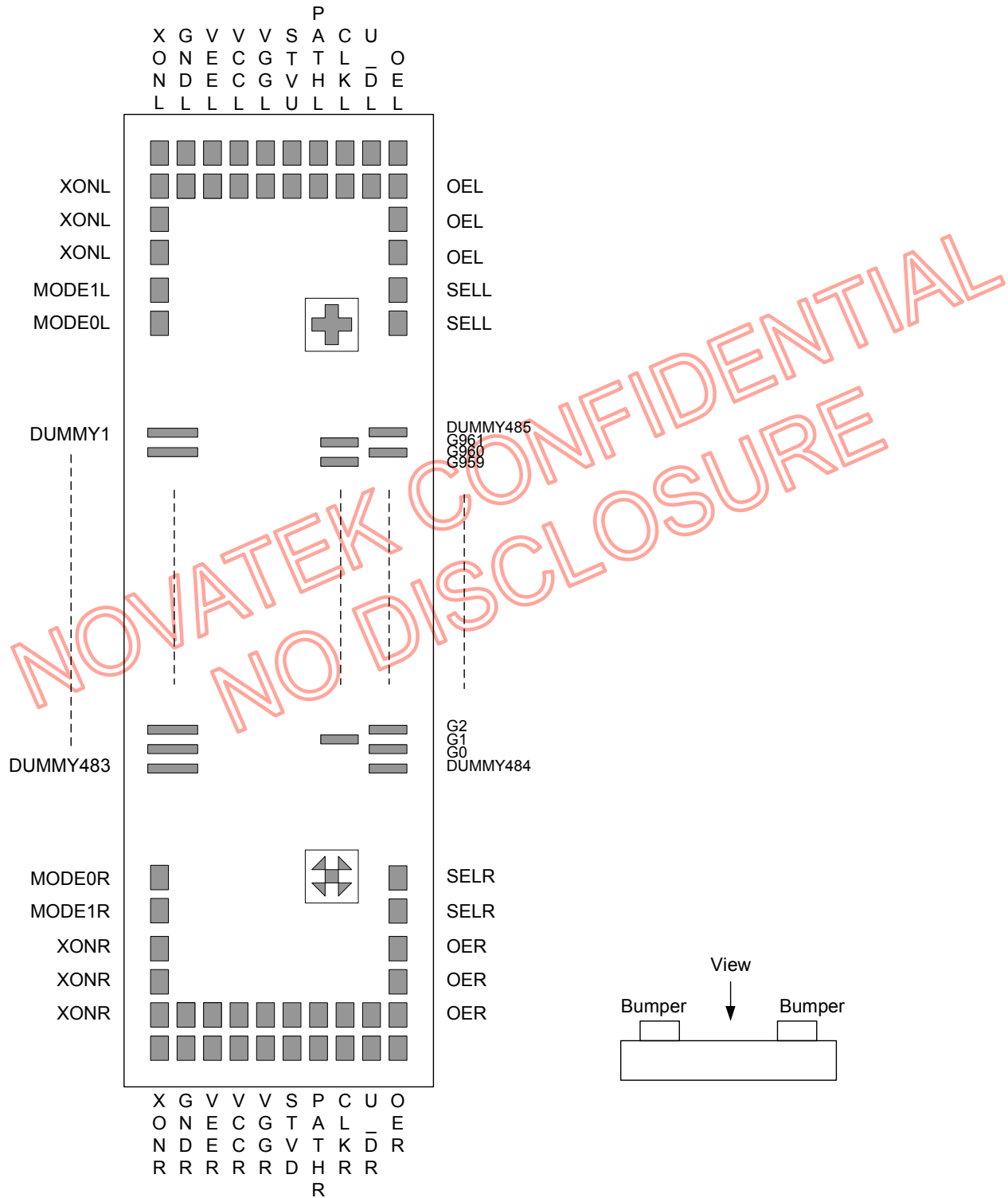
Pin Assignment

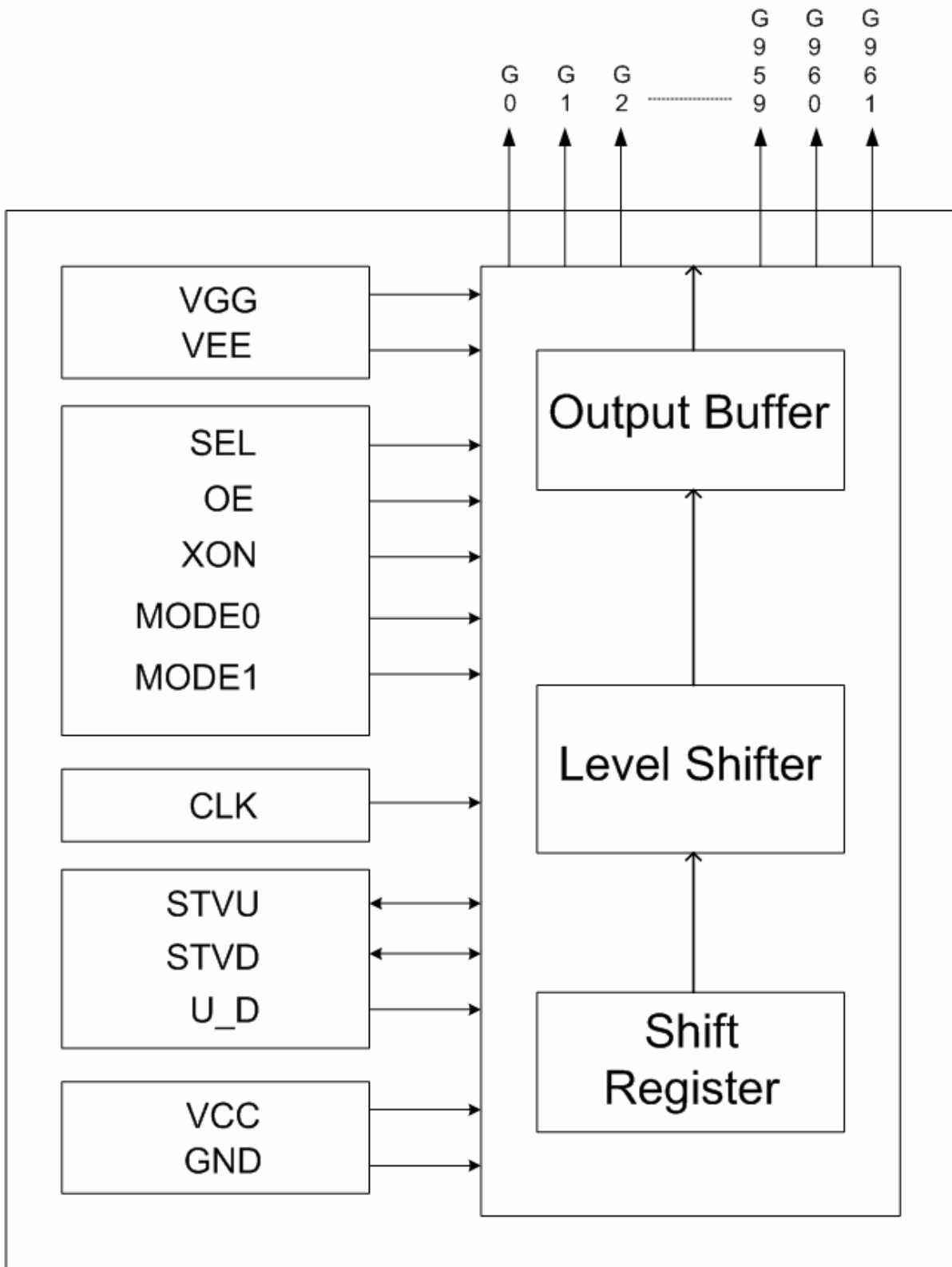
Block Diagram

Pin Descriptions

Symbol	I/O	Description
XONR, XONL (pull-up)	I	When XON goes low, all outputs are fixed to VGG. XON signal has priority over OE. Normally pull up.
OER, OEL	I	These pads are shorted internally. When this pin is applied to "H", the channel outputs are disabled (=VEE). This condition will not affect the operation of the internal registers. OE control signal is independent with the CLK.
U_DR, U_DL	I	Shift up/down control signal U_D = "H", up shift: STVD (Input) → G1 ~ G960 → STVU (Output) U_D = "L", down shift: STVU (Input) → G960 ~ G1 → STVD (Output)
SELR, SELL	I	Output sequence control This pin controls the driver output sequence. SEL=H:Normal output sequence SEL=L:Special output sequence for testing
CLKR, CLKL	I	Shift clock signal for internal shift register
PATHR, PATHL	S	Internally connected together
STVD	I/O	This pin operates as an input pin under the condition of U_D = "H" and receives a pulse signal; this pin operates as an output pin under the condition of U_D="L" and send a pulse signal. Please refer to the descriptions of "STVU" and "U_D".
STVU	I/O	This pin operates as an input pin under the condition of U_D = "L" and receives a pulse signal; this pin operates as an output pin under the condition of U_D="H" and send a pulse signal. Please refer to the descriptions of "STVD" and "U_D".
VGGR, VGGL	P	Positive power supply for G1 ~ G960 outputs
VEER, VEEL	P	Negative power supply for G0 ~ G961 outputs
VCCR, VCCL	P	Power supply for digital circuits
GNDR, GNDL	P	Ground
G1 ~ G960	O	Pulse signals for driving the gates on TFT-LCD VGG minus VEE is the amplitude of G1 ~ G960. The timing of G1 ~ G960 is synchronous with the rising edge of the shift clock CLK.
G0, G961	O	Auxiliary pins. Regardless of shift data, G0 and G961 always output the potential of VEE.

MODE0, MODE1 (pull-up)	I	Selecting the output mode: 960/816/864/800 channels,MODE0、MODE1 Normally pull up.			
		MODE0	MODE1	output channels	Remark
		0	0	800	Using G1 ~ G400 and G561 ~ G960, Others are fixed to VGL.
		0	1	816	Using G1 ~ G408 and G553 ~ G960, Others are fixed to VGL.
		1	0	864	Using G1 ~ G432 and G529 ~ G960, Others are fixed to VGL.
1	1	960	Using G1 ~ G960. Default setting		

Note: I: Input; O: Output; I/O: Input/Output; P: Power; S: Shorted line.

Pass lines and pad names

Pass Line No.	Pad Name	
1	SELR	SELL
2	OER	OEL
3	U_DR	U_DL
4	CLKR	CLKL
5	PATHR	PATHL
6	VGGR	VGGL
7	VCCR	VCCL
8	VEER	VEEL
9	GNDR	GNDL
10	XONR	XONL
11	MODE1R	MODE1L
12	MODE0R	MODE0L

Functional Descriptions

1. Power on/off sequence:

This IC is a high-voltage LCD driver, so it may be damaged by a large current flow if an incorrect power sequence is used. A recommended sequence is to connect the driver powers, VEE & VGG or VGG & VEE, after the logical power, VCC.

For power-off sequence, either turning off logic system after shutting off the driver power or turning off all power simultaneously at the same time are suggested.

■ Power on sequence – 1 (VCC → VEE → VGG)

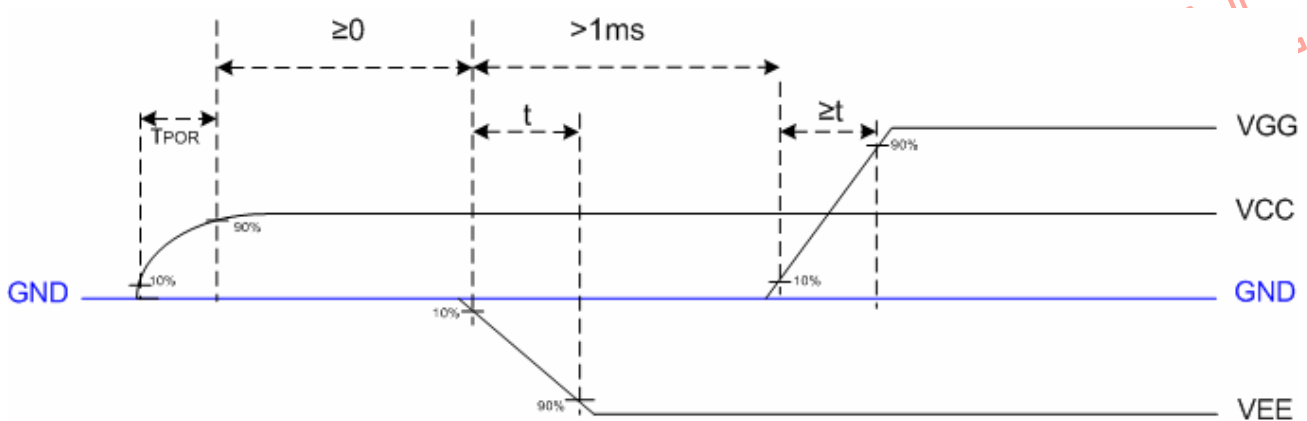

■ Power off sequence (VGG → VEE → VCC)

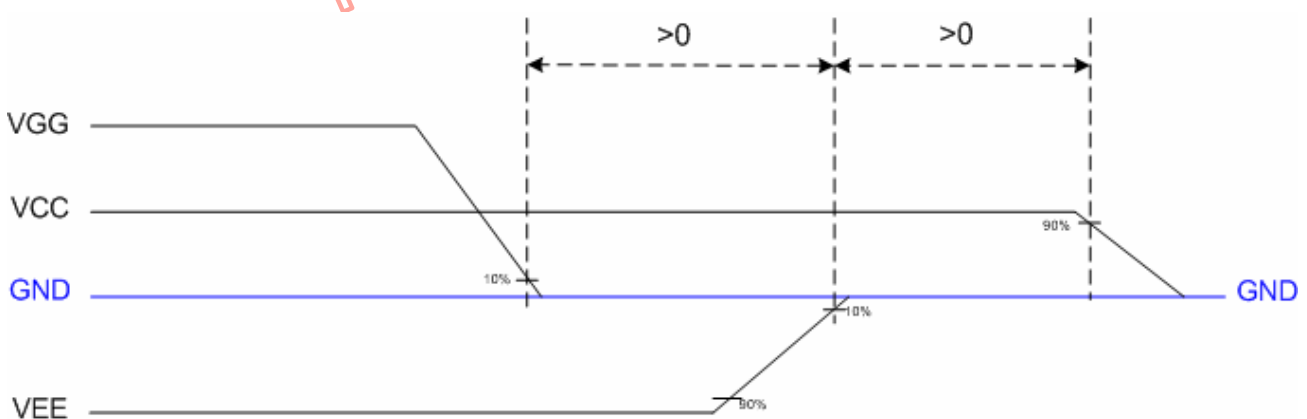

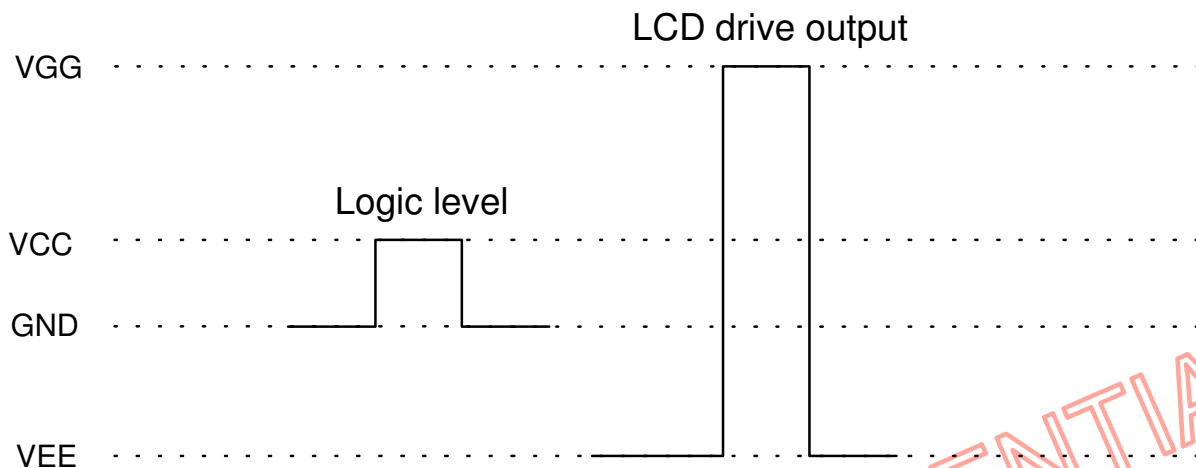
2. Power level:

Note2: For the input signals: CLK, MODE, XON, SEL, OE, U_D, STVD & STVU, "High" level = VCC, "Low" level = GND.

Absolute Maximum Ratings*

Logic supply voltage, VCC	-0.3V to +7V
Supply voltage, VGG	-0.3V to +42V
Supply voltage, VEE	-20V to +0.3V
Supply range, VGG-VEE	-0.3V to +40V
Operating temperature	-30 °C to +85 °C
Storage temperature	-55 °C to +125 °C

***Comments**

Stresses above those listed under "Absolute Maximum Rating" may cause permanent damage to the device. These are stress ratings only. Functional operation of this device at these or any other conditions above those indicated in the operational sections of this specification is not implied and exposure to absolute maximum rating conditions for extended periods may affect device reliability.

DC Electrical Characteristics

Symbol	Parameters	Min.	Typ.	Max.	Unit	Conditions
VGG	VGG Voltage	7	-	VEE + 40	V	
VEE	VEE Voltage	-20	-	-5	V	
Vxo	Voltage Range of VGG – VEE	12	-	40	V	VCC = 3.3V
VCC	VCC Supplied Voltage	2.3	3.3	3.6	V	
VIH	High Level Input Voltage	0.7VCC	-	VCC	V	VCC = 3.3V
VIL	Low Level Input Voltage	0	-	0.3VCC	V	VCC = 3.3V
IXOH	High Level Output Current	0.5	-	-	mA	Driving current, VO = VGG – 0.5V
IXOL	Low Level Output Current	-	-	-0.5	mA	Sinking current, VO = VEE + 0.5V
IPOH	High Level Output Current	200	-	-	uA	STVD/STVU, VO = VCC – 0.3V
IPOL	Low Level Output Current	-	-	-200	uA	STVD/STVU, VO = 0.3V
Rin	Pull-up Impedance	70K	200K	400K	ohm	XON · MODE pin, When VCC=3.3V and TA=25 °C
IIL	Input Leakage Current	-	-	± 1	uA	Except XON · MODE pin
ICC	Operating Current Consumption	-	-	50	uA	VCC=3.3V, Fclk=20KHz, No load
IGG	Operating Current Consumption	-	-	100	uA	VGG=25V, Fclk=20KHz, No load
IEE	Operating Current Consumption	-	-	-100	uA	VEE=-15V, Fclk=20KHz, No load

AC Electrical Characteristics (VGG=25V, VEE=-15V, VCC=3.3V, GND=0V, TA= 25 °C)

Symbol	Parameters	Min.	Typ.	Max.	Unit	Conditions
Tdt	STVD/STVU Delay Time	-	-	500	ns	CL = 20pF
Tdo	Driver Output Delay Time	-	-	900	ns	CL = 200pF
Tthl	Output Falling Time	-	400	800	ns	CL = 200pF, 90% to 10%
Tthh	Output Rising Time	-	500	1000	ns	CL = 200pF, 10% to 90%
Txon	XON to Driver Output Delay Time	-	-	20	us	CL = 200pF
Toe	OEx to Driver Output Delay Time	-	-	900	ns	CL = 200pF
Fclk	Clock Frequency	-	-	200	KHz	In cascade connection
Trck	Clock Rising Time	-	-	100	ns	CL = 20pF
Tfck	Clock Falling Time	-	-	100	ns	CL = 20pF
PWCLK	Clock Pulse Width (High & Low)	500	-	-	ns	
Tsu	STVD/STVU Set-Up Time	200	-	-	ns	
Thd	STVD/STVU Hold Time	300	-	-	ns	
Twcl	Output Enabled Pulse Width	1	-	-	us	
TPOR	Power-On Reset slew time	-	-	20	ms	From 10% to 90% VCC

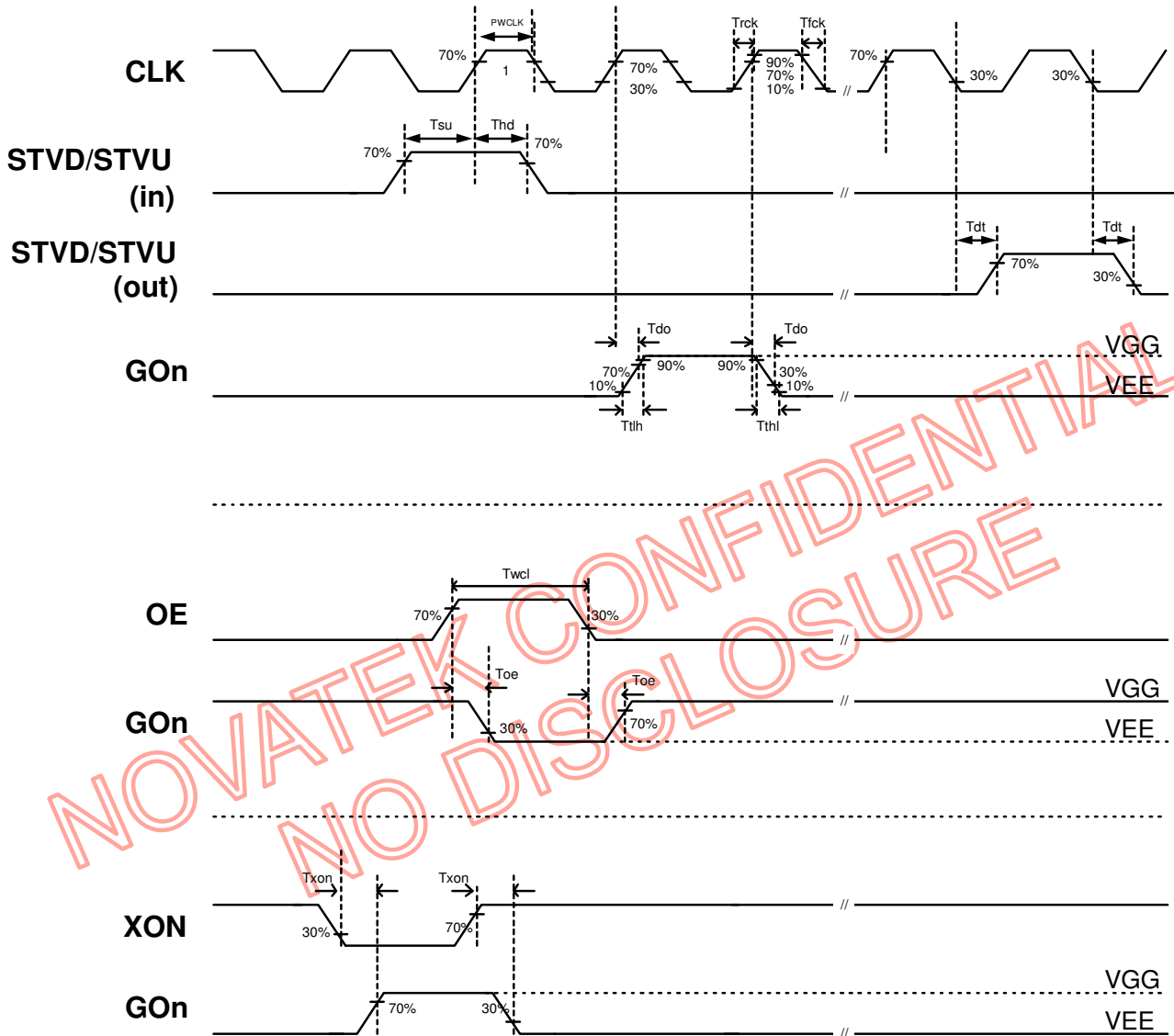
Timing Waveforms

Operating Condition :

1. U/D = "H"

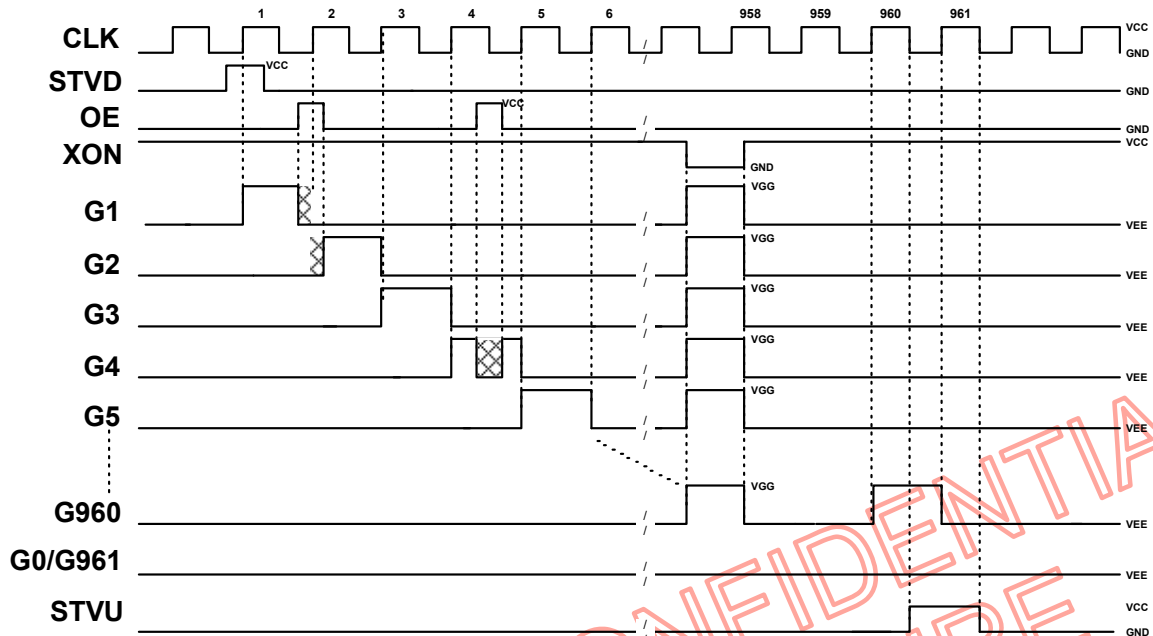

2. U/D = "L"

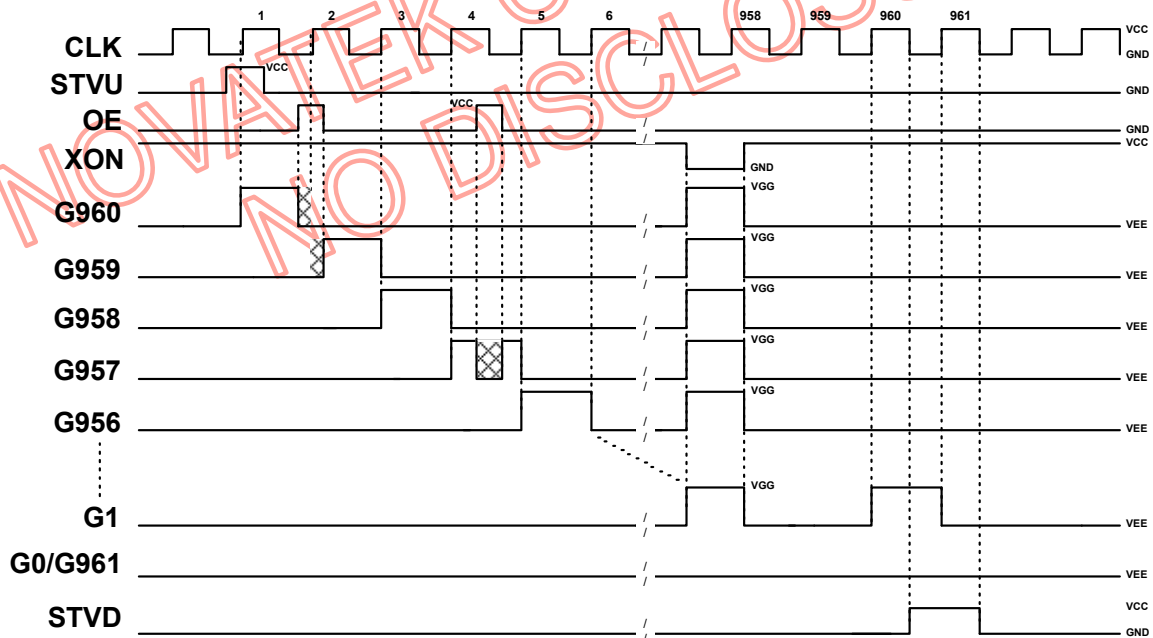

⊗ Deleted from normal output by OE

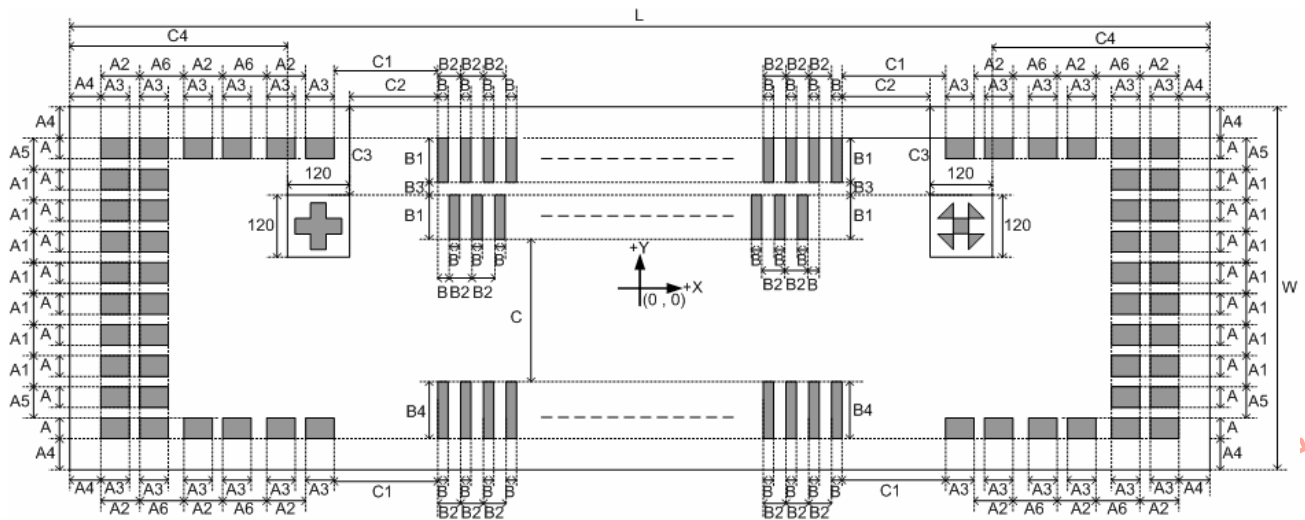
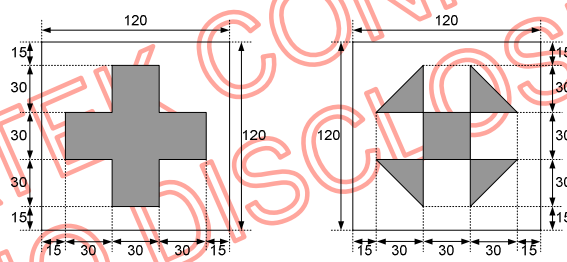
Chip Outline Dimensions

Alignment Mark Dimensions
Left Side
Right Side

Symbol	Dimensions (um)	Symbol	Dimensions (um)	Symbol	Dimensions (um)
A	40	B	22	C2	170
A1	63	B1	85	C3	160
A2	75	B2	44	C4	425
A3	55	B3	25	L	22660(Max)
A4	65	B4	110	W	740(Max)
A5	64.5	C	305		
A6	85	C1	200		

(scribe-line included)

Bonding Diagram

Pad No.	Designation	X	Y	Pad No.	Designation	X	Y
1	XONL	-11237.5	-285	41	DUMMY35	-9108	-250
2	XONL	-11162.5	-285	42	DUMMY36	-9064	-250
3	XONL	-11077.5	-285	43	DUMMY37	-9020	-250
4	XONL	-11002.5	-285	44	DUMMY38	-8976	-250
5	MODE1L	-10917.5	-285	45	DUMMY39	-8932	-250
6	MODE0L	-10842.5	-285	46	DUMMY40	-8888	-250
7	DUMMY1	-10604	-250	47	DUMMY41	-8844	-250
8	DUMMY2	-10560	-250	48	DUMMY42	-8800	-250
9	DUMMY3	-10516	-250	49	DUMMY43	-8756	-250
10	DUMMY4	-10472	-250	50	DUMMY44	-8712	-250
11	DUMMY5	-10428	-250	51	DUMMY45	-8668	-250
12	DUMMY6	-10384	-250	52	DUMMY46	-8624	-250
13	DUMMY7	-10340	-250	53	DUMMY47	-8580	-250
14	DUMMY8	-10296	-250	54	DUMMY48	-8536	-250
15	DUMMY9	-10252	-250	55	DUMMY49	-8492	-250
16	DUMMY10	-10208	-250	56	DUMMY50	-8448	-250
17	DUMMY11	-10164	-250	57	DUMMY51	-8404	-250
18	DUMMY12	-10120	-250	58	DUMMY52	-8360	-250
19	DUMMY13	-10076	-250	59	DUMMY53	-8316	-250
20	DUMMY14	-10032	-250	60	DUMMY54	-8272	-250
21	DUMMY15	-9988	-250	61	DUMMY55	-8228	-250
22	DUMMY16	-9944	-250	62	DUMMY56	-8184	-250
23	DUMMY17	-9900	-250	63	DUMMY57	-8140	-250
24	DUMMY18	-9856	-250	64	DUMMY58	-8096	-250
25	DUMMY19	-9812	-250	65	DUMMY59	-8052	-250
26	DUMMY20	-9768	-250	66	DUMMY60	-8008	-250
27	DUMMY21	-9724	-250	67	DUMMY61	-7964	-250
28	DUMMY22	-9680	-250	68	DUMMY62	-7920	-250
29	DUMMY23	-9636	-250	69	DUMMY63	-7876	-250
30	DUMMY24	-9592	-250	70	DUMMY64	-7832	-250
31	DUMMY25	-9548	-250	71	DUMMY65	-7788	-250
32	DUMMY26	-9504	-250	72	DUMMY66	-7744	-250
33	DUMMY27	-9460	-250	73	DUMMY67	-7700	-250
34	DUMMY28	-9416	-250	74	DUMMY68	-7656	-250
35	DUMMY29	-9372	-250	75	DUMMY69	-7612	-250
36	DUMMY30	-9328	-250	76	DUMMY70	-7568	-250
37	DUMMY31	-9284	-250	77	DUMMY71	-7524	-250
38	DUMMY32	-9240	-250	78	DUMMY72	-7480	-250
39	DUMMY33	-9196	-250	79	DUMMY73	-7436	-250
40	DUMMY34	-9152	-250	80	DUMMY74	-7392	-250

Pad No.	Designation	X	Y	Pad No.	Designation	X	Y
81	DUMMY75	-7348	-250	121	DUMMY115	-5588	-250
82	DUMMY76	-7304	-250	122	DUMMY116	-5544	-250
83	DUMMY77	-7260	-250	123	DUMMY117	-5500	-250
84	DUMMY78	-7216	-250	124	DUMMY118	-5456	-250
85	DUMMY79	-7172	-250	125	DUMMY119	-5412	-250
86	DUMMY80	-7128	-250	126	DUMMY120	-5368	-250
87	DUMMY81	-7084	-250	127	DUMMY121	-5324	-250
88	DUMMY82	-7040	-250	128	DUMMY122	-5280	-250
89	DUMMY83	-6996	-250	129	DUMMY123	-5236	-250
90	DUMMY84	-6952	-250	130	DUMMY124	-5192	-250
91	DUMMY85	-6908	-250	131	DUMMY125	-5148	-250
92	DUMMY86	-6864	-250	132	DUMMY126	-5104	-250
93	DUMMY87	-6820	-250	133	DUMMY127	-5060	-250
94	DUMMY88	-6776	-250	134	DUMMY128	-5016	-250
95	DUMMY89	-6732	-250	135	DUMMY129	-4972	-250
96	DUMMY90	-6688	-250	136	DUMMY130	-4928	-250
97	DUMMY91	-6644	-250	137	DUMMY131	-4884	-250
98	DUMMY92	-6600	-250	138	DUMMY132	-4840	-250
99	DUMMY93	-6556	-250	139	DUMMY133	-4796	-250
100	DUMMY94	-6512	-250	140	DUMMY134	-4752	-250
101	DUMMY95	-6468	-250	141	DUMMY135	-4708	-250
102	DUMMY96	-6424	-250	142	DUMMY136	-4664	-250
103	DUMMY97	-6380	-250	143	DUMMY137	-4620	-250
104	DUMMY98	-6336	-250	144	DUMMY138	-4576	-250
105	DUMMY99	-6292	-250	145	DUMMY139	-4532	-250
106	DUMMY100	-6248	-250	146	DUMMY140	-4488	-250
107	DUMMY101	-6204	-250	147	DUMMY141	-4444	-250
108	DUMMY102	-6160	-250	148	DUMMY142	-4400	-250
109	DUMMY103	-6116	-250	149	DUMMY143	-4356	-250
110	DUMMY104	-6072	-250	150	DUMMY144	-4312	-250
111	DUMMY105	-6028	-250	151	DUMMY145	-4268	-250
112	DUMMY106	-5984	-250	152	DUMMY146	-4224	-250
113	DUMMY107	-5940	-250	153	DUMMY147	-4180	-250
114	DUMMY108	-5896	-250	154	DUMMY148	-4136	-250
115	DUMMY109	-5852	-250	155	DUMMY149	-4092	-250
116	DUMMY110	-5808	-250	156	DUMMY150	-4048	-250
117	DUMMY111	-5764	-250	157	DUMMY151	-4004	-250
118	DUMMY112	-5720	-250	158	DUMMY152	-3960	-250
119	DUMMY113	-5676	-250	159	DUMMY153	-3916	-250
120	DUMMY114	-5632	-250	160	DUMMY154	-3872	-250

Pad No.	Designation	X	Y	Pad No.	Designation	X	Y
161	DUMMY155	-3828	-250	201	DUMMY195	-2068	-250
162	DUMMY156	-3784	-250	202	DUMMY196	-2024	-250
163	DUMMY157	-3740	-250	203	DUMMY197	-1980	-250
164	DUMMY158	-3696	-250	204	DUMMY198	-1936	-250
165	DUMMY159	-3652	-250	205	DUMMY199	-1892	-250
166	DUMMY160	-3608	-250	206	DUMMY200	-1848	-250
167	DUMMY161	-3564	-250	207	DUMMY201	-1804	-250
168	DUMMY162	-3520	-250	208	DUMMY202	-1760	-250
169	DUMMY163	-3476	-250	209	DUMMY203	-1716	-250
170	DUMMY164	-3432	-250	210	DUMMY204	-1672	-250
171	DUMMY165	-3388	-250	211	DUMMY205	-1628	-250
172	DUMMY166	-3344	-250	212	DUMMY206	-1584	-250
173	DUMMY167	-3300	-250	213	DUMMY207	-1540	-250
174	DUMMY168	-3256	-250	214	DUMMY208	-1496	-250
175	DUMMY169	-3212	-250	215	DUMMY209	-1452	-250
176	DUMMY170	-3168	-250	216	DUMMY210	-1408	-250
177	DUMMY171	-3124	-250	217	DUMMY211	-1364	-250
178	DUMMY172	-3080	-250	218	DUMMY212	-1320	-250
179	DUMMY173	-3036	-250	219	DUMMY213	-1276	-250
180	DUMMY174	-2992	-250	220	DUMMY214	-1232	-250
181	DUMMY175	-2948	-250	221	DUMMY215	-1188	-250
182	DUMMY176	-2904	-250	222	DUMMY216	-1144	-250
183	DUMMY177	-2860	-250	223	DUMMY217	-1100	-250
184	DUMMY178	-2816	-250	224	DUMMY218	-1056	-250
185	DUMMY179	-2772	-250	225	DUMMY219	-1012	-250
186	DUMMY180	-2728	-250	226	DUMMY220	-968	-250
187	DUMMY181	-2684	-250	227	DUMMY221	-924	-250
188	DUMMY182	-2640	-250	228	DUMMY222	-880	-250
189	DUMMY183	-2596	-250	229	DUMMY223	-836	-250
190	DUMMY184	-2552	-250	230	DUMMY224	-792	-250
191	DUMMY185	-2508	-250	231	DUMMY225	-748	-250
192	DUMMY186	-2464	-250	232	DUMMY226	-704	-250
193	DUMMY187	-2420	-250	233	DUMMY227	-660	-250
194	DUMMY188	-2376	-250	234	DUMMY228	-616	-250
195	DUMMY189	-2332	-250	235	DUMMY229	-572	-250
196	DUMMY190	-2288	-250	236	DUMMY230	-528	-250
197	DUMMY191	-2244	-250	237	DUMMY231	-484	-250
198	DUMMY192	-2200	-250	238	DUMMY232	-440	-250
199	DUMMY193	-2156	-250	239	DUMMY233	-396	-250
200	DUMMY194	-2112	-250	240	DUMMY234	-352	-250

Pad No.	Designation	X	Y	Pad No.	Designation	X	Y
241	DUMMY235	-308	-250	281	DUMMY275	1452	-250
242	DUMMY236	-264	-250	282	DUMMY276	1496	-250
243	DUMMY237	-220	-250	283	DUMMY277	1540	-250
244	DUMMY238	-176	-250	284	DUMMY278	1584	-250
245	DUMMY239	-132	-250	285	DUMMY279	1628	-250
246	DUMMY240	-88	-250	286	DUMMY280	1672	-250
247	DUMMY241	-44	-250	287	DUMMY281	1716	-250
248	DUMMY242	0	-250	288	DUMMY282	1760	-250
249	DUMMY243	44	-250	289	DUMMY283	1804	-250
250	DUMMY244	88	-250	290	DUMMY284	1848	-250
251	DUMMY245	132	-250	291	DUMMY285	1892	-250
252	DUMMY246	176	-250	292	DUMMY286	1936	-250
253	DUMMY247	220	-250	293	DUMMY287	1980	-250
254	DUMMY248	264	-250	294	DUMMY288	2024	-250
255	DUMMY249	308	-250	295	DUMMY289	2068	-250
256	DUMMY250	352	-250	296	DUMMY290	2112	-250
257	DUMMY251	396	-250	297	DUMMY291	2156	-250
258	DUMMY252	440	-250	298	DUMMY292	2200	-250
259	DUMMY253	484	-250	299	DUMMY293	2244	-250
260	DUMMY254	528	-250	300	DUMMY294	2288	-250
261	DUMMY255	572	-250	301	DUMMY295	2332	-250
262	DUMMY256	616	-250	302	DUMMY296	2376	-250
263	DUMMY257	660	-250	303	DUMMY297	2420	-250
264	DUMMY258	704	-250	304	DUMMY298	2464	-250
265	DUMMY259	748	-250	305	DUMMY299	2508	-250
266	DUMMY260	792	-250	306	DUMMY300	2552	-250
267	DUMMY261	836	-250	307	DUMMY301	2596	-250
268	DUMMY262	880	-250	308	DUMMY302	2640	-250
269	DUMMY263	924	-250	309	DUMMY303	2684	-250
270	DUMMY264	968	-250	310	DUMMY304	2728	-250
271	DUMMY265	1012	-250	311	DUMMY305	2772	-250
272	DUMMY266	1056	-250	312	DUMMY306	2816	-250
273	DUMMY267	1100	-250	313	DUMMY307	2860	-250
274	DUMMY268	1144	-250	314	DUMMY308	2904	-250
275	DUMMY269	1188	-250	315	DUMMY309	2948	-250
276	DUMMY270	1232	-250	316	DUMMY310	2992	-250
277	DUMMY271	1276	-250	317	DUMMY311	3036	-250
278	DUMMY272	1320	-250	318	DUMMY312	3080	-250
279	DUMMY273	1364	-250	319	DUMMY313	3124	-250
280	DUMMY274	1408	-250	320	DUMMY314	3168	-250

Pad No.	Designation	X	Y	Pad No.	Designation	X	Y
321	DUMMY315	3212	-250	361	DUMMY355	4972	-250
322	DUMMY316	3256	-250	362	DUMMY356	5016	-250
323	DUMMY317	3300	-250	363	DUMMY357	5060	-250
324	DUMMY318	3344	-250	364	DUMMY358	5104	-250
325	DUMMY319	3388	-250	365	DUMMY359	5148	-250
326	DUMMY320	3432	-250	366	DUMMY360	5192	-250
327	DUMMY321	3476	-250	367	DUMMY361	5236	-250
328	DUMMY322	3520	-250	368	DUMMY362	5280	-250
329	DUMMY323	3564	-250	369	DUMMY363	5324	-250
330	DUMMY324	3608	-250	370	DUMMY364	5368	-250
331	DUMMY325	3652	-250	371	DUMMY365	5412	-250
332	DUMMY326	3696	-250	372	DUMMY366	5456	-250
333	DUMMY327	3740	-250	373	DUMMY367	5500	-250
334	DUMMY328	3784	-250	374	DUMMY368	5544	-250
335	DUMMY329	3828	-250	375	DUMMY369	5588	-250
336	DUMMY330	3872	-250	376	DUMMY370	5632	-250
337	DUMMY331	3916	-250	377	DUMMY371	5676	-250
338	DUMMY332	3960	-250	378	DUMMY372	5720	-250
339	DUMMY333	4004	-250	379	DUMMY373	5764	-250
340	DUMMY334	4048	-250	380	DUMMY374	5808	-250
341	DUMMY335	4092	-250	381	DUMMY375	5852	-250
342	DUMMY336	4136	-250	382	DUMMY376	5896	-250
343	DUMMY337	4180	-250	383	DUMMY377	5940	-250
344	DUMMY338	4224	-250	384	DUMMY378	5984	-250
345	DUMMY339	4268	-250	385	DUMMY379	6028	-250
346	DUMMY340	4312	-250	386	DUMMY380	6072	-250
347	DUMMY341	4356	-250	387	DUMMY381	6116	-250
348	DUMMY342	4400	-250	388	DUMMY382	6160	-250
349	DUMMY343	4444	-250	389	DUMMY383	6204	-250
350	DUMMY344	4488	-250	390	DUMMY384	6248	-250
351	DUMMY345	4532	-250	391	DUMMY385	6292	-250
352	DUMMY346	4576	-250	392	DUMMY386	6336	-250
353	DUMMY347	4620	-250	393	DUMMY387	6380	-250
354	DUMMY348	4664	-250	394	DUMMY388	6424	-250
355	DUMMY349	4708	-250	395	DUMMY389	6468	-250
356	DUMMY350	4752	-250	396	DUMMY390	6512	-250
357	DUMMY351	4796	-250	397	DUMMY391	6556	-250
358	DUMMY352	4840	-250	398	DUMMY392	6600	-250
359	DUMMY353	4884	-250	399	DUMMY393	6644	-250
360	DUMMY354	4928	-250	400	DUMMY394	6688	-250

Pad No.	Designation	X	Y	Pad No.	Designation	X	Y
401	DUMMY395	6732	-250	441	DUMMY435	8492	-250
402	DUMMY396	6776	-250	442	DUMMY436	8536	-250
403	DUMMY397	6820	-250	443	DUMMY437	8580	-250
404	DUMMY398	6864	-250	444	DUMMY438	8624	-250
405	DUMMY399	6908	-250	445	DUMMY439	8668	-250
406	DUMMY400	6952	-250	446	DUMMY440	8712	-250
407	DUMMY401	6996	-250	447	DUMMY441	8756	-250
408	DUMMY402	7040	-250	448	DUMMY442	8800	-250
409	DUMMY403	7084	-250	449	DUMMY443	8844	-250
410	DUMMY404	7128	-250	450	DUMMY444	8888	-250
411	DUMMY405	7172	-250	451	DUMMY445	8932	-250
412	DUMMY406	7216	-250	452	DUMMY446	8976	-250
413	DUMMY407	7260	-250	453	DUMMY447	9020	-250
414	DUMMY408	7304	-250	454	DUMMY448	9064	-250
415	DUMMY409	7348	-250	455	DUMMY449	9108	-250
416	DUMMY410	7392	-250	456	DUMMY450	9152	-250
417	DUMMY411	7436	-250	457	DUMMY451	9196	-250
418	DUMMY412	7480	-250	458	DUMMY452	9240	-250
419	DUMMY413	7524	-250	459	DUMMY453	9284	-250
420	DUMMY414	7568	-250	460	DUMMY454	9328	-250
421	DUMMY415	7612	-250	461	DUMMY455	9372	-250
422	DUMMY416	7656	-250	462	DUMMY456	9416	-250
423	DUMMY417	7700	-250	463	DUMMY457	9460	-250
424	DUMMY418	7744	-250	464	DUMMY458	9504	-250
425	DUMMY419	7788	-250	465	DUMMY459	9548	-250
426	DUMMY420	7832	-250	466	DUMMY460	9592	-250
427	DUMMY421	7876	-250	467	DUMMY461	9636	-250
428	DUMMY422	7920	-250	468	DUMMY462	9680	-250
429	DUMMY423	7964	-250	469	DUMMY463	9724	-250
430	DUMMY424	8008	-250	470	DUMMY464	9768	-250
431	DUMMY425	8052	-250	471	DUMMY465	9812	-250
432	DUMMY426	8096	-250	472	DUMMY466	9856	-250
433	DUMMY427	8140	-250	473	DUMMY467	9900	-250
434	DUMMY428	8184	-250	474	DUMMY468	9944	-250
435	DUMMY429	8228	-250	475	DUMMY469	9988	-250
436	DUMMY430	8272	-250	476	DUMMY470	10032	-250
437	DUMMY431	8316	-250	477	DUMMY471	10076	-250
438	DUMMY432	8360	-250	478	DUMMY472	10120	-250
439	DUMMY433	8404	-250	479	DUMMY473	10164	-250
440	DUMMY434	8448	-250	480	DUMMY474	10208	-250

Pad No.	Designation	X	Y	Pad No.	Designation	X	Y
481	DUMMY475	10252	-250	521	G2	10516	262.5
482	DUMMY476	10296	-250	522	G3	10494	152.5
483	DUMMY477	10340	-250	523	G4	10472	262.5
484	DUMMY478	10384	-250	524	G5	10450	152.5
485	DUMMY479	10428	-250	525	G6	10428	262.5
486	DUMMY480	10472	-250	526	G7	10406	152.5
487	DUMMY481	10516	-250	527	G8	10384	262.5
488	DUMMY482	10560	-250	528	G9	10362	152.5
489	DUMMY483	10604	-250	529	G10	10340	262.5
490	MODE0R	10842.5	-285	530	G11	10318	152.5
491	MODE1R	10917.5	-285	531	G12	10296	262.5
492	XONR	11002.5	-285	532	G13	10274	152.5
493	XONR	11077.5	-285	533	G14	10252	262.5
494	XONR	11162.5	-285	534	G15	10230	152.5
495	XONR	11237.5	-285	535	G16	10208	262.5
496	GNDR	11162.5	-220.5	536	G17	10186	152.5
497	GNDR	11237.5	-220.5	537	G18	10164	262.5
498	VEER	11162.5	-157.5	538	G19	10142	152.5
499	VEER	11237.5	-157.5	539	G20	10120	262.5
500	VCCR	11162.5	-94.5	540	G21	10098	152.5
501	VCCR	11237.5	-94.5	541	G22	10076	262.5
502	VGGR	11162.5	-31.5	542	G23	10054	152.5
503	VGGR	11237.5	-31.5	543	G24	10032	262.5
504	STVD	11162.5	31.5	544	G25	10010	152.5
505	STVD	11237.5	31.5	545	G26	9988	262.5
506	PATHR	11162.5	94.5	546	G27	9966	152.5
507	PATHR	11237.5	94.5	547	G28	9944	262.5
508	CLKR	11162.5	157.5	548	G29	9922	152.5
509	CLKR	11237.5	157.5	549	G30	9900	262.5
510	U_DR	11162.5	220.5	550	G31	9878	152.5
511	U_DR	11237.5	220.5	551	G32	9856	262.5
512	OER	11237.5	285	552	G33	9834	152.5
513	OER	11162.5	285	553	G34	9812	262.5
514	OER	11077.5	285	554	G35	9790	152.5
515	OER	11002.5	285	555	G36	9768	262.5
516	SELR	10917.5	285	556	G37	9746	152.5
517	SELR	10842.5	285	557	G38	9724	262.5
518	DUMMY484	10604	262.5	558	G39	9702	152.5
519	G0	10560	262.5	559	G40	9680	262.5
520	G1	10538	152.5	560	G41	9658	152.5

Pad No.	Designation	X	Y	Pad No.	Designation	X	Y
561	G42	9636	262.5	601	G82	8756	262.5
562	G43	9614	152.5	602	G83	8734	152.5
563	G44	9592	262.5	603	G84	8712	262.5
564	G45	9570	152.5	604	G85	8690	152.5
565	G46	9548	262.5	605	G86	8668	262.5
566	G47	9526	152.5	606	G87	8646	152.5
567	G48	9504	262.5	607	G88	8624	262.5
568	G49	9482	152.5	608	G89	8602	152.5
569	G50	9460	262.5	609	G90	8580	262.5
570	G51	9438	152.5	610	G91	8558	152.5
571	G52	9416	262.5	611	G92	8536	262.5
572	G53	9394	152.5	612	G93	8514	152.5
573	G54	9372	262.5	613	G94	8492	262.5
574	G55	9350	152.5	614	G95	8470	152.5
575	G56	9328	262.5	615	G96	8448	262.5
576	G57	9306	152.5	616	G97	8426	152.5
577	G58	9284	262.5	617	G98	8404	262.5
578	G59	9262	152.5	618	G99	8382	152.5
579	G60	9240	262.5	619	G100	8360	262.5
580	G61	9218	152.5	620	G101	8338	152.5
581	G62	9196	262.5	621	G102	8316	262.5
582	G63	9174	152.5	622	G103	8294	152.5
583	G64	9152	262.5	623	G104	8272	262.5
584	G65	9130	152.5	624	G105	8250	152.5
585	G66	9108	262.5	625	G106	8228	262.5
586	G67	9086	152.5	626	G107	8206	152.5
587	G68	9064	262.5	627	G108	8184	262.5
588	G69	9042	152.5	628	G109	8162	152.5
589	G70	9020	262.5	629	G110	8140	262.5
590	G71	8998	152.5	630	G111	8118	152.5
591	G72	8976	262.5	631	G112	8096	262.5
592	G73	8954	152.5	632	G113	8074	152.5
593	G74	8932	262.5	633	G114	8052	262.5
594	G75	8910	152.5	634	G115	8030	152.5
595	G76	8888	262.5	635	G116	8008	262.5
596	G77	8866	152.5	636	G117	7986	152.5
597	G78	8844	262.5	637	G118	7964	262.5
598	G79	8822	152.5	638	G119	7942	152.5
599	G80	8800	262.5	639	G120	7920	262.5
600	G81	8778	152.5	640	G121	7898	152.5

Pad No.	Designation	X	Y	Pad No.	Designation	X	Y
641	G122	7876	262.5	681	G162	6996	262.5
642	G123	7854	152.5	682	G163	6974	152.5
643	G124	7832	262.5	683	G164	6952	262.5
644	G125	7810	152.5	684	G165	6930	152.5
645	G126	7788	262.5	685	G166	6908	262.5
646	G127	7766	152.5	686	G167	6886	152.5
647	G128	7744	262.5	687	G168	6864	262.5
648	G129	7722	152.5	688	G169	6842	152.5
649	G130	7700	262.5	689	G170	6820	262.5
650	G131	7678	152.5	690	G171	6798	152.5
651	G132	7656	262.5	691	G172	6776	262.5
652	G133	7634	152.5	692	G173	6754	152.5
653	G134	7612	262.5	693	G174	6732	262.5
654	G135	7590	152.5	694	G175	6710	152.5
655	G136	7568	262.5	695	G176	6688	262.5
656	G137	7546	152.5	696	G177	6666	152.5
657	G138	7524	262.5	697	G178	6644	262.5
658	G139	7502	152.5	698	G179	6622	152.5
659	G140	7480	262.5	699	G180	6600	262.5
660	G141	7458	152.5	700	G181	6578	152.5
661	G142	7436	262.5	701	G182	6556	262.5
662	G143	7414	152.5	702	G183	6534	152.5
663	G144	7392	262.5	703	G184	6512	262.5
664	G145	7370	152.5	704	G185	6490	152.5
665	G146	7348	262.5	705	G186	6468	262.5
666	G147	7326	152.5	706	G187	6446	152.5
667	G148	7304	262.5	707	G188	6424	262.5
668	G149	7282	152.5	708	G189	6402	152.5
669	G150	7260	262.5	709	G190	6380	262.5
670	G151	7238	152.5	710	G191	6358	152.5
671	G152	7216	262.5	711	G192	6336	262.5
672	G153	7194	152.5	712	G193	6314	152.5
673	G154	7172	262.5	713	G194	6292	262.5
674	G155	7150	152.5	714	G195	6270	152.5
675	G156	7128	262.5	715	G196	6248	262.5
676	G157	7106	152.5	716	G197	6226	152.5
677	G158	7084	262.5	717	G198	6204	262.5
678	G159	7062	152.5	718	G199	6182	152.5
679	G160	7040	262.5	719	G200	6160	262.5
680	G161	7018	152.5	720	G201	6138	152.5

Pad No.	Designation	X	Y	Pad No.	Designation	X	Y
721	G202	6116	262.5	761	G242	5236	262.5
722	G203	6094	152.5	762	G243	5214	152.5
723	G204	6072	262.5	763	G244	5192	262.5
724	G205	6050	152.5	764	G245	5170	152.5
725	G206	6028	262.5	765	G246	5148	262.5
726	G207	6006	152.5	766	G247	5126	152.5
727	G208	5984	262.5	767	G248	5104	262.5
728	G209	5962	152.5	768	G249	5082	152.5
729	G210	5940	262.5	769	G250	5060	262.5
730	G211	5918	152.5	770	G251	5038	152.5
731	G212	5896	262.5	771	G252	5016	262.5
732	G213	5874	152.5	772	G253	4994	152.5
733	G214	5852	262.5	773	G254	4972	262.5
734	G215	5830	152.5	774	G255	4950	152.5
735	G216	5808	262.5	775	G256	4928	262.5
736	G217	5786	152.5	776	G257	4906	152.5
737	G218	5764	262.5	777	G258	4884	262.5
738	G219	5742	152.5	778	G259	4862	152.5
739	G220	5720	262.5	779	G260	4840	262.5
740	G221	5698	152.5	780	G261	4818	152.5
741	G222	5676	262.5	781	G262	4796	262.5
742	G223	5654	152.5	782	G263	4774	152.5
743	G224	5632	262.5	783	G264	4752	262.5
744	G225	5610	152.5	784	G265	4730	152.5
745	G226	5588	262.5	785	G266	4708	262.5
746	G227	5566	152.5	786	G267	4686	152.5
747	G228	5544	262.5	787	G268	4664	262.5
748	G229	5522	152.5	788	G269	4642	152.5
749	G230	5500	262.5	789	G270	4620	262.5
750	G231	5478	152.5	790	G271	4598	152.5
751	G232	5456	262.5	791	G272	4576	262.5
752	G233	5434	152.5	792	G273	4554	152.5
753	G234	5412	262.5	793	G274	4532	262.5
754	G235	5390	152.5	794	G275	4510	152.5
755	G236	5368	262.5	795	G276	4488	262.5
756	G237	5346	152.5	796	G277	4466	152.5
757	G238	5324	262.5	797	G278	4444	262.5
758	G239	5302	152.5	798	G279	4422	152.5
759	G240	5280	262.5	799	G280	4400	262.5
760	G241	5258	152.5	800	G281	4378	152.5

Pad No.	Designation	X	Y	Pad No.	Designation	X	Y
801	G282	4356	262.5	841	G322	3476	262.5
802	G283	4334	152.5	842	G323	3454	152.5
803	G284	4312	262.5	843	G324	3432	262.5
804	G285	4290	152.5	844	G325	3410	152.5
805	G286	4268	262.5	845	G326	3388	262.5
806	G287	4246	152.5	846	G327	3366	152.5
807	G288	4224	262.5	847	G328	3344	262.5
808	G289	4202	152.5	848	G329	3322	152.5
809	G290	4180	262.5	849	G330	3300	262.5
810	G291	4158	152.5	850	G331	3278	152.5
811	G292	4136	262.5	851	G332	3256	262.5
812	G293	4114	152.5	852	G333	3234	152.5
813	G294	4092	262.5	853	G334	3212	262.5
814	G295	4070	152.5	854	G335	3190	152.5
815	G296	4048	262.5	855	G336	3168	262.5
816	G297	4026	152.5	856	G337	3146	152.5
817	G298	4004	262.5	857	G338	3124	262.5
818	G299	3982	152.5	858	G339	3102	152.5
819	G300	3960	262.5	859	G340	3080	262.5
820	G301	3938	152.5	860	G341	3058	152.5
821	G302	3916	262.5	861	G342	3036	262.5
822	G303	3894	152.5	862	G343	3014	152.5
823	G304	3872	262.5	863	G344	2992	262.5
824	G305	3850	152.5	864	G345	2970	152.5
825	G306	3828	262.5	865	G346	2948	262.5
826	G307	3806	152.5	866	G347	2926	152.5
827	G308	3784	262.5	867	G348	2904	262.5
828	G309	3762	152.5	868	G349	2882	152.5
829	G310	3740	262.5	869	G350	2860	262.5
830	G311	3718	152.5	870	G351	2838	152.5
831	G312	3696	262.5	871	G352	2816	262.5
832	G313	3674	152.5	872	G353	2794	152.5
833	G314	3652	262.5	873	G354	2772	262.5
834	G315	3630	152.5	874	G355	2750	152.5
835	G316	3608	262.5	875	G356	2728	262.5
836	G317	3586	152.5	876	G357	2706	152.5
837	G318	3564	262.5	877	G358	2684	262.5
838	G319	3542	152.5	878	G359	2662	152.5
839	G320	3520	262.5	879	G360	2640	262.5
840	G321	3498	152.5	880	G361	2618	152.5

Pad No.	Designation	X	Y	Pad No.	Designation	X	Y
881	G362	2596	262.5	921	G402	1716	262.5
882	G363	2574	152.5	922	G403	1694	152.5
883	G364	2552	262.5	923	G404	1672	262.5
884	G365	2530	152.5	924	G405	1650	152.5
885	G366	2508	262.5	925	G406	1628	262.5
886	G367	2486	152.5	926	G407	1606	152.5
887	G368	2464	262.5	927	G408	1584	262.5
888	G369	2442	152.5	928	G409	1562	152.5
889	G370	2420	262.5	929	G410	1540	262.5
890	G371	2398	152.5	930	G411	1518	152.5
891	G372	2376	262.5	931	G412	1496	262.5
892	G373	2354	152.5	932	G413	1474	152.5
893	G374	2332	262.5	933	G414	1452	262.5
894	G375	2310	152.5	934	G415	1430	152.5
895	G376	2288	262.5	935	G416	1408	262.5
896	G377	2266	152.5	936	G417	1386	152.5
897	G378	2244	262.5	937	G418	1364	262.5
898	G379	2222	152.5	938	G419	1342	152.5
899	G380	2200	262.5	939	G420	1320	262.5
900	G381	2178	152.5	940	G421	1298	152.5
901	G382	2156	262.5	941	G422	1276	262.5
902	G383	2134	152.5	942	G423	1254	152.5
903	G384	2112	262.5	943	G424	1232	262.5
904	G385	2090	152.5	944	G425	1210	152.5
905	G386	2068	262.5	945	G426	1188	262.5
906	G387	2046	152.5	946	G427	1166	152.5
907	G388	2024	262.5	947	G428	1144	262.5
908	G389	2002	152.5	948	G429	1122	152.5
909	G390	1980	262.5	949	G430	1100	262.5
910	G391	1958	152.5	950	G431	1078	152.5
911	G392	1936	262.5	951	G432	1056	262.5
912	G393	1914	152.5	952	G433	1034	152.5
913	G394	1892	262.5	953	G434	1012	262.5
914	G395	1870	152.5	954	G435	990	152.5
915	G396	1848	262.5	955	G436	968	262.5
916	G397	1826	152.5	956	G437	946	152.5
917	G398	1804	262.5	957	G438	924	262.5
918	G399	1782	152.5	958	G439	902	152.5
919	G400	1760	262.5	959	G440	880	262.5
920	G401	1738	152.5	960	G441	858	152.5

Pad No.	Designation	X	Y	Pad No.	Designation	X	Y
961	G442	836	262.5	1001	G482	-44	262.5
962	G443	814	152.5	1002	G483	-66	152.5
963	G444	792	262.5	1003	G484	-88	262.5
964	G445	770	152.5	1004	G485	-110	152.5
965	G446	748	262.5	1005	G486	-132	262.5
966	G447	726	152.5	1006	G487	-154	152.5
967	G448	704	262.5	1007	G488	-176	262.5
968	G449	682	152.5	1008	G489	-198	152.5
969	G450	660	262.5	1009	G490	-220	262.5
970	G451	638	152.5	1010	G491	-242	152.5
971	G452	616	262.5	1011	G492	-264	262.5
972	G453	594	152.5	1012	G493	-286	152.5
973	G454	572	262.5	1013	G494	-308	262.5
974	G455	550	152.5	1014	G495	-330	152.5
975	G456	528	262.5	1015	G496	-352	262.5
976	G457	506	152.5	1016	G497	-374	152.5
977	G458	484	262.5	1017	G498	-396	262.5
978	G459	462	152.5	1018	G499	-418	152.5
979	G460	440	262.5	1019	G500	-440	262.5
980	G461	418	152.5	1020	G501	-462	152.5
981	G462	396	262.5	1021	G502	-484	262.5
982	G463	374	152.5	1022	G503	-506	152.5
983	G464	352	262.5	1023	G504	-528	262.5
984	G465	330	152.5	1024	G505	-550	152.5
985	G466	308	262.5	1025	G506	-572	262.5
986	G467	286	152.5	1026	G507	-594	152.5
987	G468	264	262.5	1027	G508	-616	262.5
988	G469	242	152.5	1028	G509	-638	152.5
989	G470	220	262.5	1029	G510	-660	262.5
990	G471	198	152.5	1030	G511	-682	152.5
991	G472	176	262.5	1031	G512	-704	262.5
992	G473	154	152.5	1032	G513	-726	152.5
993	G474	132	262.5	1033	G514	-748	262.5
994	G475	110	152.5	1034	G515	-770	152.5
995	G476	88	262.5	1035	G516	-792	262.5
996	G477	66	152.5	1036	G517	-814	152.5
997	G478	44	262.5	1037	G518	-836	262.5
998	G479	22	152.5	1038	G519	-858	152.5
999	G480	0	262.5	1039	G520	-880	262.5
1000	G481	-22	152.5	1040	G521	-902	152.5

Pad No.	Designation	X	Y	Pad No.	Designation	X	Y
1041	G522	-924	262.5	1081	G562	-1804	262.5
1042	G523	-946	152.5	1082	G563	-1826	152.5
1043	G524	-968	262.5	1083	G564	-1848	262.5
1044	G525	-990	152.5	1084	G565	-1870	152.5
1045	G526	-1012	262.5	1085	G566	-1892	262.5
1046	G527	-1034	152.5	1086	G567	-1914	152.5
1047	G528	-1056	262.5	1087	G568	-1936	262.5
1048	G529	-1078	152.5	1088	G569	-1958	152.5
1049	G530	-1100	262.5	1089	G570	-1980	262.5
1050	G531	-1122	152.5	1090	G571	-2002	152.5
1051	G532	-1144	262.5	1091	G572	-2024	262.5
1052	G533	-1166	152.5	1092	G573	-2046	152.5
1053	G534	-1188	262.5	1093	G574	-2068	262.5
1054	G535	-1210	152.5	1094	G575	-2090	152.5
1055	G536	-1232	262.5	1095	G576	-2112	262.5
1056	G537	-1254	152.5	1096	G577	-2134	152.5
1057	G538	-1276	262.5	1097	G578	-2156	262.5
1058	G539	-1298	152.5	1098	G579	-2178	152.5
1059	G540	-1320	262.5	1099	G580	-2200	262.5
1060	G541	-1342	152.5	1100	G581	-2222	152.5
1061	G542	-1364	262.5	1101	G582	-2244	262.5
1062	G543	-1386	152.5	1102	G583	-2266	152.5
1063	G544	-1408	262.5	1103	G584	-2288	262.5
1064	G545	-1430	152.5	1104	G585	-2310	152.5
1065	G546	-1452	262.5	1105	G586	-2332	262.5
1066	G547	-1474	152.5	1106	G587	-2354	152.5
1067	G548	-1496	262.5	1107	G588	-2376	262.5
1068	G549	-1518	152.5	1108	G589	-2398	152.5
1069	G550	-1540	262.5	1109	G590	-2420	262.5
1070	G551	-1562	152.5	1110	G591	-2442	152.5
1071	G552	-1584	262.5	1111	G592	-2464	262.5
1072	G553	-1606	152.5	1112	G593	-2486	152.5
1073	G554	-1628	262.5	1113	G594	-2508	262.5
1074	G555	-1650	152.5	1114	G595	-2530	152.5
1075	G556	-1672	262.5	1115	G596	-2552	262.5
1076	G557	-1694	152.5	1116	G597	-2574	152.5
1077	G558	-1716	262.5	1117	G598	-2596	262.5
1078	G559	-1738	152.5	1118	G599	-2618	152.5
1079	G560	-1760	262.5	1119	G600	-2640	262.5
1080	G561	-1782	152.5	1120	G601	-2662	152.5

Pad No.	Designation	X	Y	Pad No.	Designation	X	Y
1121	G602	-2684	262.5	1161	G642	-3564	262.5
1122	G603	-2706	152.5	1162	G643	-3586	152.5
1123	G604	-2728	262.5	1163	G644	-3608	262.5
1124	G605	-2750	152.5	1164	G645	-3630	152.5
1125	G606	-2772	262.5	1165	G646	-3652	262.5
1126	G607	-2794	152.5	1166	G647	-3674	152.5
1127	G608	-2816	262.5	1167	G648	-3696	262.5
1128	G609	-2838	152.5	1168	G649	-3718	152.5
1129	G610	-2860	262.5	1169	G650	-3740	262.5
1130	G611	-2882	152.5	1170	G651	-3762	152.5
1131	G612	-2904	262.5	1171	G652	-3784	262.5
1132	G613	-2926	152.5	1172	G653	-3806	152.5
1133	G614	-2948	262.5	1173	G654	-3828	262.5
1134	G615	-2970	152.5	1174	G655	-3850	152.5
1135	G616	-2992	262.5	1175	G656	-3872	262.5
1136	G617	-3014	152.5	1176	G657	-3894	152.5
1137	G618	-3036	262.5	1177	G658	-3916	262.5
1138	G619	-3058	152.5	1178	G659	-3938	152.5
1139	G620	-3080	262.5	1179	G660	-3960	262.5
1140	G621	-3102	152.5	1180	G661	-3982	152.5
1141	G622	-3124	262.5	1181	G662	-4004	262.5
1142	G623	-3146	152.5	1182	G663	-4026	152.5
1143	G624	-3168	262.5	1183	G664	-4048	262.5
1144	G625	-3190	152.5	1184	G665	-4070	152.5
1145	G626	-3212	262.5	1185	G666	-4092	262.5
1146	G627	-3234	152.5	1186	G667	-4114	152.5
1147	G628	-3256	262.5	1187	G668	-4136	262.5
1148	G629	-3278	152.5	1188	G669	-4158	152.5
1149	G630	-3300	262.5	1189	G670	-4180	262.5
1150	G631	-3322	152.5	1190	G671	-4202	152.5
1151	G632	-3344	262.5	1191	G672	-4224	262.5
1152	G633	-3366	152.5	1192	G673	-4246	152.5
1153	G634	-3388	262.5	1193	G674	-4268	262.5
1154	G635	-3410	152.5	1194	G675	-4290	152.5
1155	G636	-3432	262.5	1195	G676	-4312	262.5
1156	G637	-3454	152.5	1196	G677	-4334	152.5
1157	G638	-3476	262.5	1197	G678	-4356	262.5
1158	G639	-3498	152.5	1198	G679	-4378	152.5
1159	G640	-3520	262.5	1199	G680	-4400	262.5
1160	G641	-3542	152.5	1200	G681	-4422	152.5

Pad No.	Designation	X	Y	Pad No.	Designation	X	Y
1201	G682	-4444	262.5	1241	G722	-5324	262.5
1202	G683	-4466	152.5	1242	G723	-5346	152.5
1203	G684	-4488	262.5	1243	G724	-5368	262.5
1204	G685	-4510	152.5	1244	G725	-5390	152.5
1205	G686	-4532	262.5	1245	G726	-5412	262.5
1206	G687	-4554	152.5	1246	G727	-5434	152.5
1207	G688	-4576	262.5	1247	G728	-5456	262.5
1208	G689	-4598	152.5	1248	G729	-5478	152.5
1209	G690	-4620	262.5	1249	G730	-5500	262.5
1210	G691	-4642	152.5	1250	G731	-5522	152.5
1211	G692	-4664	262.5	1251	G732	-5544	262.5
1212	G693	-4686	152.5	1252	G733	-5566	152.5
1213	G694	-4708	262.5	1253	G734	-5588	262.5
1214	G695	-4730	152.5	1254	G735	-5610	152.5
1215	G696	-4752	262.5	1255	G736	-5632	262.5
1216	G697	-4774	152.5	1256	G737	-5654	152.5
1217	G698	-4796	262.5	1257	G738	-5676	262.5
1218	G699	-4818	152.5	1258	G739	-5698	152.5
1219	G700	-4840	262.5	1259	G740	-5720	262.5
1220	G701	-4862	152.5	1260	G741	-5742	152.5
1221	G702	-4884	262.5	1261	G742	-5764	262.5
1222	G703	-4906	152.5	1262	G743	-5786	152.5
1223	G704	-4928	262.5	1263	G744	-5808	262.5
1224	G705	-4950	152.5	1264	G745	-5830	152.5
1225	G706	-4972	262.5	1265	G746	-5852	262.5
1226	G707	-4994	152.5	1266	G747	-5874	152.5
1227	G708	-5016	262.5	1267	G748	-5896	262.5
1228	G709	-5038	152.5	1268	G749	-5918	152.5
1229	G710	-5060	262.5	1269	G750	-5940	262.5
1230	G711	-5082	152.5	1270	G751	-5962	152.5
1231	G712	-5104	262.5	1271	G752	-5984	262.5
1232	G713	-5126	152.5	1272	G753	-6006	152.5
1233	G714	-5148	262.5	1273	G754	-6028	262.5
1234	G715	-5170	152.5	1274	G755	-6050	152.5
1235	G716	-5192	262.5	1275	G756	-6072	262.5
1236	G717	-5214	152.5	1276	G757	-6094	152.5
1237	G718	-5236	262.5	1277	G758	-6116	262.5
1238	G719	-5258	152.5	1278	G759	-6138	152.5
1239	G720	-5280	262.5	1279	G760	-6160	262.5
1240	G721	-5302	152.5	1280	G761	-6182	152.5

Pad No.	Designation	X	Y	Pad No.	Designation	X	Y
1281	G762	-6204	262.5	1321	G802	-7084	262.5
1282	G763	-6226	152.5	1322	G803	-7106	152.5
1283	G764	-6248	262.5	1323	G804	-7128	262.5
1284	G765	-6270	152.5	1324	G805	-7150	152.5
1285	G766	-6292	262.5	1325	G806	-7172	262.5
1286	G767	-6314	152.5	1326	G807	-7194	152.5
1287	G768	-6336	262.5	1327	G808	-7216	262.5
1288	G769	-6358	152.5	1328	G809	-7238	152.5
1289	G770	-6380	262.5	1329	G810	-7260	262.5
1290	G771	-6402	152.5	1330	G811	-7282	152.5
1291	G772	-6424	262.5	1331	G812	-7304	262.5
1292	G773	-6446	152.5	1332	G813	-7326	152.5
1293	G774	-6468	262.5	1333	G814	-7348	262.5
1294	G775	-6490	152.5	1334	G815	-7370	152.5
1295	G776	-6512	262.5	1335	G816	-7392	262.5
1296	G777	-6534	152.5	1336	G817	-7414	152.5
1297	G778	-6556	262.5	1337	G818	-7436	262.5
1298	G779	-6578	152.5	1338	G819	-7458	152.5
1299	G780	-6600	262.5	1339	G820	-7480	262.5
1300	G781	-6622	152.5	1340	G821	-7502	152.5
1301	G782	-6644	262.5	1341	G822	-7524	262.5
1302	G783	-6666	152.5	1342	G823	-7546	152.5
1303	G784	-6688	262.5	1343	G824	-7568	262.5
1304	G785	-6710	152.5	1344	G825	-7590	152.5
1305	G786	-6732	262.5	1345	G826	-7612	262.5
1306	G787	-6754	152.5	1346	G827	-7634	152.5
1307	G788	-6776	262.5	1347	G828	-7656	262.5
1308	G789	-6798	152.5	1348	G829	-7678	152.5
1309	G790	-6820	262.5	1349	G830	-7700	262.5
1310	G791	-6842	152.5	1350	G831	-7722	152.5
1311	G792	-6864	262.5	1351	G832	-7744	262.5
1312	G793	-6886	152.5	1352	G833	-7766	152.5
1313	G794	-6908	262.5	1353	G834	-7788	262.5
1314	G795	-6930	152.5	1354	G835	-7810	152.5
1315	G796	-6952	262.5	1355	G836	-7832	262.5
1316	G797	-6974	152.5	1356	G837	-7854	152.5
1317	G798	-6996	262.5	1357	G838	-7876	262.5
1318	G799	-7018	152.5	1358	G839	-7898	152.5
1319	G800	-7040	262.5	1359	G840	-7920	262.5
1320	G801	-7062	152.5	1360	G841	-7942	152.5

Pad No.	Designation	X	Y	Pad No.	Designation	X	Y
1361	G842	-7964	262.5	1401	G882	-8844	262.5
1362	G843	-7986	152.5	1402	G883	-8866	152.5
1363	G844	-8008	262.5	1403	G884	-8888	262.5
1364	G845	-8030	152.5	1404	G885	-8910	152.5
1365	G846	-8052	262.5	1405	G886	-8932	262.5
1366	G847	-8074	152.5	1406	G887	-8954	152.5
1367	G848	-8096	262.5	1407	G888	-8976	262.5
1368	G849	-8118	152.5	1408	G889	-8998	152.5
1369	G850	-8140	262.5	1409	G890	-9020	262.5
1370	G851	-8162	152.5	1410	G891	-9042	152.5
1371	G852	-8184	262.5	1411	G892	-9064	262.5
1372	G853	-8206	152.5	1412	G893	-9086	152.5
1373	G854	-8228	262.5	1413	G894	-9108	262.5
1374	G855	-8250	152.5	1414	G895	-9130	152.5
1375	G856	-8272	262.5	1415	G896	-9152	262.5
1376	G857	-8294	152.5	1416	G897	-9174	152.5
1377	G858	-8316	262.5	1417	G898	-9196	262.5
1378	G859	-8338	152.5	1418	G899	-9218	152.5
1379	G860	-8360	262.5	1419	G900	-9240	262.5
1380	G861	-8382	152.5	1420	G901	-9262	152.5
1381	G862	-8404	262.5	1421	G902	-9284	262.5
1382	G863	-8426	152.5	1422	G903	-9306	152.5
1383	G864	-8448	262.5	1423	G904	-9328	262.5
1384	G865	-8470	152.5	1424	G905	-9350	152.5
1385	G866	-8492	262.5	1425	G906	-9372	262.5
1386	G867	-8514	152.5	1426	G907	-9394	152.5
1387	G868	-8536	262.5	1427	G908	-9416	262.5
1388	G869	-8558	152.5	1428	G909	-9438	152.5
1389	G870	-8580	262.5	1429	G910	-9460	262.5
1390	G871	-8602	152.5	1430	G911	-9482	152.5
1391	G872	-8624	262.5	1431	G912	-9504	262.5
1392	G873	-8646	152.5	1432	G913	-9526	152.5
1393	G874	-8668	262.5	1433	G914	-9548	262.5
1394	G875	-8690	152.5	1434	G915	-9570	152.5
1395	G876	-8712	262.5	1435	G916	-9592	262.5
1396	G877	-8734	152.5	1436	G917	-9614	152.5
1397	G878	-8756	262.5	1437	G918	-9636	262.5
1398	G879	-8778	152.5	1438	G919	-9658	152.5
1399	G880	-8800	262.5	1439	G920	-9680	262.5
1400	G881	-8822	152.5	1440	G921	-9702	152.5

Pad No.	Designation	X	Y	Pad No.	Designation	X	Y
1441	G922	-9724	262.5	1481	DUMMY485	-10604	262.5
1442	G923	-9746	152.5	1482	SELL	-10842.5	285
1443	G924	-9768	262.5	1483	SELL	-10917.5	285
1444	G925	-9790	152.5	1484	OEL	-11002.5	285
1445	G926	-9812	262.5	1485	OEL	-11077.5	285
1446	G927	-9834	152.5	1486	OEL	-11162.5	285
1447	G928	-9856	262.5	1487	OEL	-11237.5	285
1448	G929	-9878	152.5	1488	U_DL	-11237.5	220.5
1449	G930	-9900	262.5	1489	U_DL	-11162.5	220.5
1450	G931	-9922	152.5	1490	CLKL	-11237.5	157.5
1451	G932	-9944	262.5	1491	CLKL	-11162.5	157.5
1452	G933	-9966	152.5	1492	PATHL	-11237.5	94.5
1453	G934	-9988	262.5	1493	PATHL	-11162.5	94.5
1454	G935	-10010	152.5	1494	STVU	-11237.5	31.5
1455	G936	-10032	262.5	1495	STVU	-11162.5	31.5
1456	G937	-10054	152.5	1496	VGGL	-11237.5	-31.5
1457	G938	-10076	262.5	1497	VGGL	-11162.5	-31.5
1458	G939	-10098	152.5	1498	VCCL	-11237.5	-94.5
1459	G940	-10120	262.5	1499	VCCL	-11162.5	-94.5
1460	G941	-10142	152.5	1500	VEEL	-11237.5	-157.5
1461	G942	-10164	262.5	1501	VEEL	-11162.5	-157.5
1462	G943	-10186	152.5	1502	GNDL	-11237.5	-220.5
1463	G944	-10208	262.5	1503	GNDL	-11162.5	-220.5
1464	G945	-10230	152.5	1504	AL_MARK_L	-10845	150
1465	G946	-10252	262.5	1505	AL_MARK_R	10845	150
1466	G947	-10274	152.5				
1467	G948	-10296	262.5				
1468	G949	-10318	152.5				
1469	G950	-10340	262.5				
1470	G951	-10362	152.5				
1471	G952	-10384	262.5				
1472	G953	-10406	152.5				
1473	G954	-10428	262.5				
1474	G955	-10450	152.5				
1475	G956	-10472	262.5				
1476	G957	-10494	152.5				
1477	G958	-10516	262.5				
1478	G959	-10538	152.5				
1479	G960	-10560	262.5				
1480	G961	-10582	152.5				