

NTMD3N08LR2

Advance Information

Power MOSFET 2.3 Amps, 80 Volts

N-Channel Enhancement-Mode SO-8 Dual Package

Features

- Ultra Low On-Resistance Provides Higher Efficiency
 - ◆ $R_{DS(on)} = 0.215 \Omega$, $V_{GS} = 10 \text{ V}$
 - ◆ $R_{DS(on)} = 0.245 \Omega$, $V_{GS} = 5.0 \text{ V}$
- Low Reverse Recovery Losses
- Internal $R_G = 50 \Omega$
- *Designed for Power Management Solutions in 42 V Automotive System Applications*
- I_{DSS} and $R_{DS(on)}$ Specified at Elevated Temperature
- Avalanche Energy Specified
- Miniature SO-8 Surface Mount Package – Saves Board Space
- Mounting Information for SO-8 Package Provided

Applications

- Integrated Starter Alternator
- Electronic Power Steering
- Electronic Fuel Injection
- Catalytic Converter Heaters

MAXIMUM RATINGS ($T_J = 25^\circ\text{C}$ unless otherwise noted)

Rating	Symbol	Value	Unit
Drain-to-Source Voltage	V_{DSS}	80	V
Drain-to-Source Voltage ($R_{GS} = 1.0 \text{ m}\Omega$)	V_{DGR}	80	V
Gate-to-Source Voltage – Continuous	V_{GS}	± 15	V
Gate-to-Source Voltage – Non-Repetitive ($t_p \leq 10 \text{ ms}$)	V_{GSM}	± 20	V
Continuous Drain Current @ $T_A = 25^\circ\text{C}$	I_D	2.3	A
Pulsed Drain Current (Note 1)	I_{DM}	25	A
Total Power Dissipation @ $T_A = 25^\circ\text{C}$ (Note 2)	P_D	3.1	W
Operating and Storage Temperature Range	T_J, T_{stg}	-55 to +175	$^\circ\text{C}$
Single Pulse Drain-to-Source Avalanche Energy – Starting $T_J = 25^\circ\text{C}$ ($V_{DD} = 50 \text{ Vdc}$, $V_{GS} = 5.0 \text{ Vdc}$, Peak $I_L = 7.0 \text{ Apk}$, $L = 1.0 \text{ mH}$, $R_G = 25 \Omega$)	E_{AS}	25	mJ
Thermal Resistance – Junction-to-Ambient (Note 2)	$R_{\theta JA}$	48	$^\circ\text{C/W}$
Maximum Lead Temperature for Soldering Purposes for 10 Seconds	T_L	260	$^\circ\text{C}$

1. Pulse Test: Pulse Width = $10 \mu\text{s}$, Duty Cycle = 2%
2. Mounted onto a 2" square FR-4 board (1" sq. oz. Cu 0.06" thick single sided), $t \leq 5$ seconds

This document contains information on a new product. Specifications and information herein are subject to change without notice.



ON Semiconductor®

<http://onsemi.com>

2.3 AMPERES
80 VOLTS
215 m Ω @ $V_{GS} = 5 \text{ V}$ (Typ)

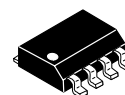

DUAL SO-8
CASE 751
STYLE 11

MARKING DIAGRAM & PIN ASSIGNMENT

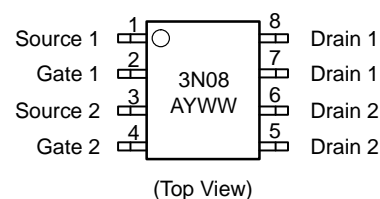

3N08 = Specific Device Code
A = Assembly Location
Y = Year
WW = Work Week

ORDERING INFORMATION

Device	Package	Shipping
NTMD3N08LR2	SO-8	2500/Tape & Reel

NTMD3N08LR2

ELECTRICAL CHARACTERISTICS (T_C = 25°C unless otherwise noted)

Characteristic	Symbol	Min	Typ	Max	Unit
----------------	--------	-----	-----	-----	------

OFF CHARACTERISTICS

Drain-to-Source Breakdown Voltage (V _{GS} = 0 Vdc, I _D = 250 μAdc) Positive Temperature Coefficient	V _{(BR)DSS}	80 –	– 99.8	– –	Vdc mV/°C
Zero Gate Voltage Drain Current (V _{DS} = 80 Vdc, V _{GS} = 0 Vdc) (V _{DS} = 80 Vdc, V _{GS} = 0 Vdc, T _J = 150°C)	I _{DSS}	– –	– –	10 250	μAdc
Gate-Body Leakage Current (V _{GS} = 15 Vdc, V _{DS} = 0 Vdc) (V _{GS} = -15 Vdc, V _{DS} = 0 Vdc)	I _{GSS}	– –	– –	100 -100	nAdc

ON CHARACTERISTICS

Gate Threshold Voltage (V _{DS} = V _{GS} , I _D = 250 μAdc) Negative Temperature Coefficient	V _{GS(th)}	1.0 –	1.9 4.6	3.0 –	Vdc mV/°C
Static Drain-to-Source On-State Resistance (V _{GS} = 5.0 Vdc, I _D = 1.0 Adc) (V _{GS} = 10 Vdc, I _D = 2.5 Adc) (V _{GS} = 4.5 Vdc, I _D = 1.0 Adc, T _J @ 150°C)	R _{DS(on)}	– – –	0.215 0.190 0.446	0.245 0.215 0.505	Ω

DYNAMIC CHARACTERISTICS

Input Capacitance (V _{DS} = 25 Vdc, V _{GS} = 0 Vdc, f = 1.0 MHz)	C _{iss}	–	218	480	pF
Output Capacitance (V _{DS} = 25 Vdc, V _{GS} = 0 Vdc, f = 1.0 MHz)	C _{oss}	–	54	150	
Reverse Transfer Capacitance (V _{DS} = 25 Vdc, V _{GS} = 0 Vdc, f = 1.0 MHz)	C _{rss}	–	15	50	

SWITCHING CHARACTERISTICS (Notes 3 and 4)

Turn-On Delay Time (V _{DD} = 40 Vdc, I _D = 1.0 A, V _{GS} = 4.5 V, R _G = 27 Ω) (V _{DD} = 40 Vdc, I _D = 2.5 A, V _{GS} = 10 V, R _G = 47 Ω)	t _{d(on)}	– –	21 13	34 –	ns
Rise Time (V _{DD} = 40 Vdc, I _D = 1.0 A, V _{GS} = 4.5 V, R _G = 27 Ω) (V _{DD} = 40 Vdc, I _D = 2.5 A, V _{GS} = 10 V, R _G = 47 Ω)	t _r	– –	62 95	104 –	
Turn-Off Delay Time (V _{DD} = 40 Vdc, I _D = 1.0 A, V _{GS} = 4.5 V, R _G = 27 Ω) (V _{DD} = 40 Vdc, I _D = 2.5 A, V _{GS} = 10 V, R _G = 47 Ω)	t _{d(off)}	– –	52 47	85 –	
Fall Time (V _{DD} = 40 Vdc, I _D = 1.0 A, V _{GS} = 4.5 V, R _G = 27 Ω) (V _{DD} = 40 Vdc, I _D = 2.5 A, V _{GS} = 10 V, R _G = 47 Ω)	t _f	– –	48 104	81 –	
Total Gate Charge (V _{DS} = 40 Vdc, V _{GS} = 5.0 Vdc, I _D = 1.0 A) (V _{DS} = 40 Vdc, V _{GS} = 10 Vdc, I _D = 1.0 A)	Q _{tot}	– –	4.0 7.5	9.0 15	nC
Gate-Source Charge (V _{DS} = 40 Vdc, V _{GS} = 5.0 Vdc, I _D = 1.0 A)	Q ₁	–	1.16	–	
Gate-Drain Charge (V _{DS} = 40 Vdc, V _{GS} = 5.0 Vdc, I _D = 1.0 A)	Q ₂	–	2.11	–	

BODY-DRAIN DIODE RATINGS (Note 3)

Diode Forward On-Voltage (I _S = 1.0 Adc, V _{GS} = 0 V) (I _S = 1.0 Adc, V _{GS} = 0 V, T _J = 150°C)	V _{SD}	– –	0.8 1.4	1.0 –	Vdc
Reverse Recovery Time (I _S = 1.0 A, dI _S /dt = 100 A/μs, V _{GS} = 0 V)	t _{rr}	–	47	93	ns
	t _a	–	25	–	
	t _b	–	22	–	
Reverse Recovery Stored Charge (I _S = 1.0 A, dI _S /dt = 100 A/μs, V _{GS} = 0 V)	Q _{RR}	–	0.067	0.134	μC

3. Indicates Pulse Test: Pulse Width = 300 μs max, Duty Cycle = 2%.

4. Switching characteristics are independent of operating junction temperatures.

TYPICAL ELECTRICAL CHARACTERISTICS

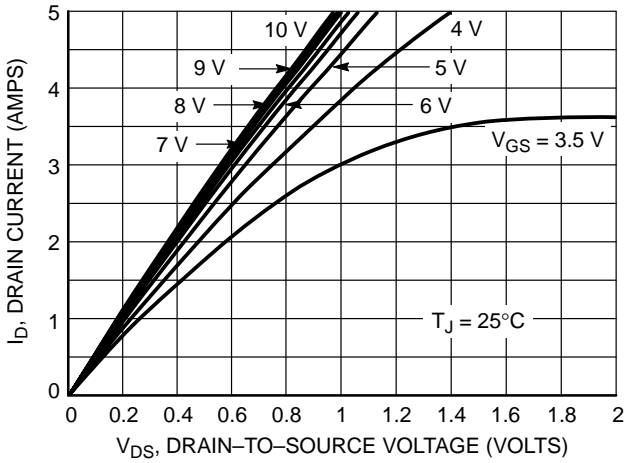

Figure 1. On-Region Characteristics

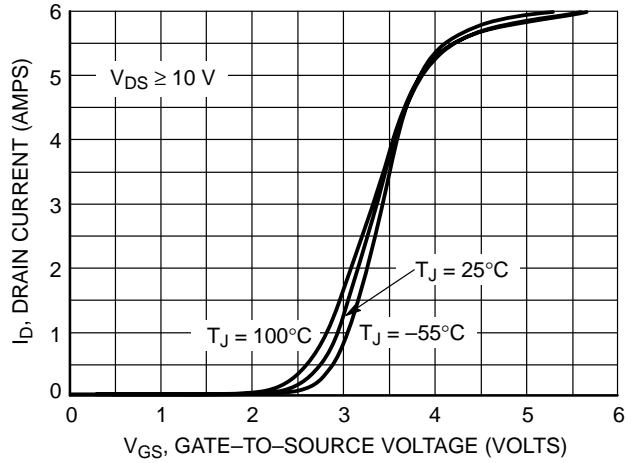

Figure 2. Transfer Characteristics

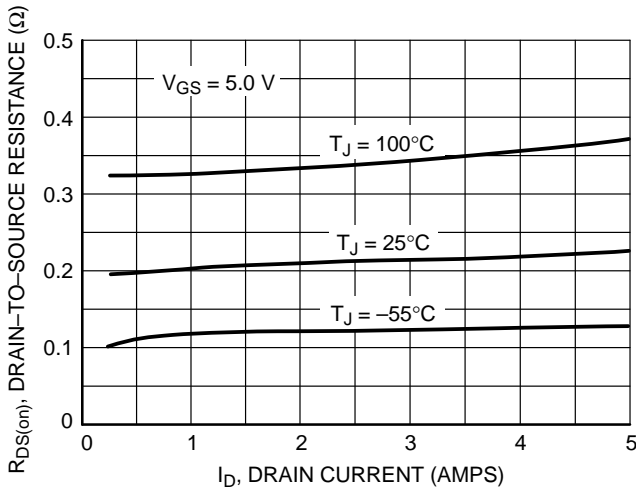

Figure 3. On-Resistance versus Drain Current and Temperature

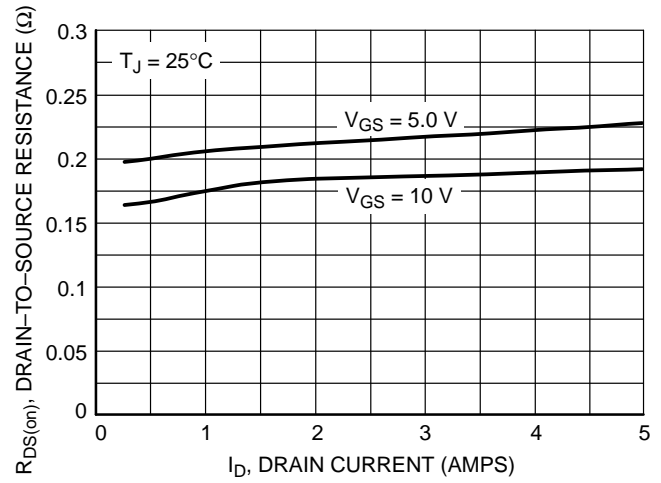

Figure 4. On-Resistance versus Drain Current and Gate Voltage

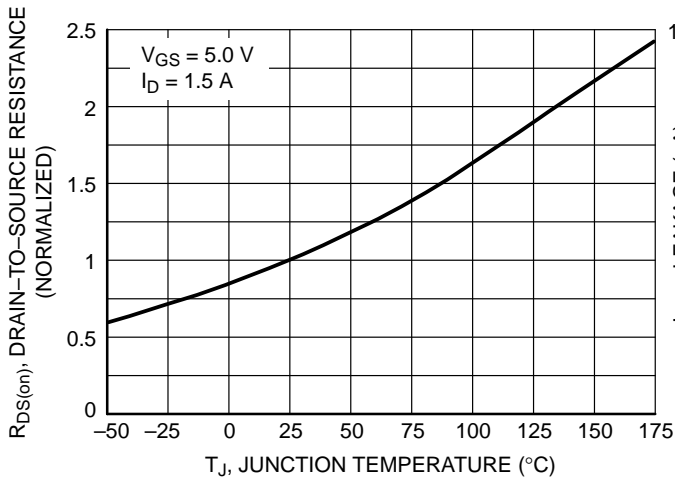

Figure 5. On-Resistance Variation with Temperature

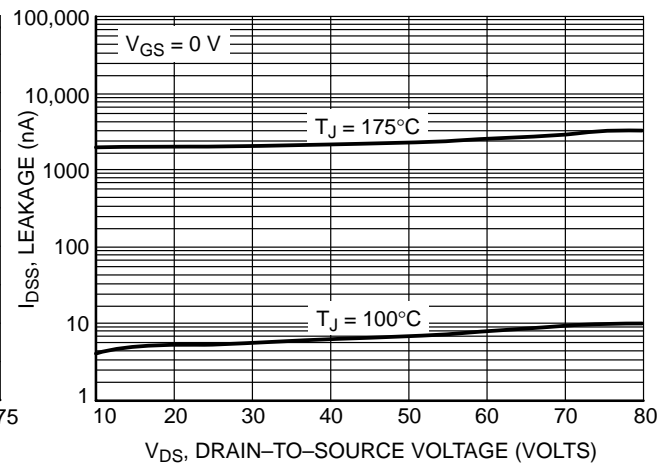

Figure 6. Drain-To-Source Leakage Current versus Voltage

POWER MOSFET SWITCHING

Switching behavior is most easily modeled and predicted by recognizing that the power MOSFET is charge controlled. The lengths of various switching intervals (Δt) are determined by how fast the FET input capacitance can be charged by current from the generator.

The published capacitance data is difficult to use for calculating rise and fall because drain-gate capacitance varies greatly with applied voltage. Accordingly, gate charge data is used. In most cases, a satisfactory estimate of average input current ($I_{G(AV)}$) can be made from a rudimentary analysis of the drive circuit so that

$$t = Q/I_{G(AV)}$$

During the rise and fall time interval when switching a resistive load, V_{GS} remains virtually constant at a level known as the plateau voltage, V_{GSP} . Therefore, rise and fall times may be approximated by the following:

$$t_r = Q_2 \times R_G / (V_{GG} - V_{GSP})$$

$$t_f = Q_2 \times R_G / V_{GSP}$$

where

V_{GG} = the gate drive voltage, which varies from zero to V_{GG}

R_G = the gate drive resistance

and Q_2 and V_{GSP} are read from the gate charge curve.

During the turn-on and turn-off delay times, gate current is not constant. The simplest calculation uses appropriate values from the capacitance curves in a standard equation for voltage change in an RC network. The equations are:

$$t_{d(on)} = R_G C_{iss} \ln [V_{GG}/(V_{GG} - V_{GSP})]$$

$$t_{d(off)} = R_G C_{iss} \ln (V_{GG}/V_{GSP})$$

The capacitance (C_{iss}) is read from the capacitance curve at a voltage corresponding to the off-state condition when calculating $t_{d(on)}$ and is read at a voltage corresponding to the on-state when calculating $t_{d(off)}$.

At high switching speeds, parasitic circuit elements complicate the analysis. The inductance of the MOSFET source lead, inside the package and in the circuit wiring which is common to both the drain and gate current paths, produces a voltage at the source which reduces the gate drive current. The voltage is determined by $L di/dt$, but since di/dt is a function of drain current, the mathematical solution is complex. The MOSFET output capacitance also complicates the mathematics. And finally, MOSFETs have finite internal gate resistance which effectively adds to the resistance of the driving source, but the internal resistance is difficult to measure and, consequently, is not specified.

The resistive switching time variation versus gate resistance (Figure 9) shows how typical switching performance is affected by the parasitic circuit elements. If the parasitics were not present, the slope of the curves would maintain a value of unity regardless of the switching speed. The circuit used to obtain the data is constructed to minimize common inductance in the drain and gate circuit loops and is believed readily achievable with board mounted components. Most power electronic loads are inductive; the data in the figure is taken with a resistive load, which approximates an optimally snubbed inductive load. Power MOSFETs may be safely operated into an inductive load; however, snubbing reduces switching losses.

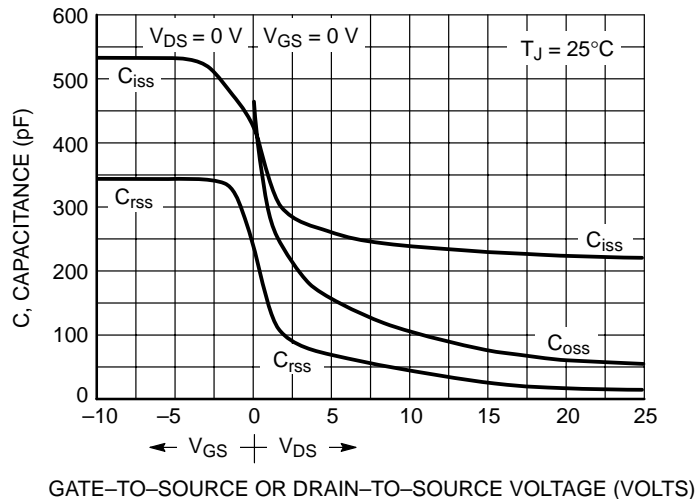

Figure 7. Capacitance Variation

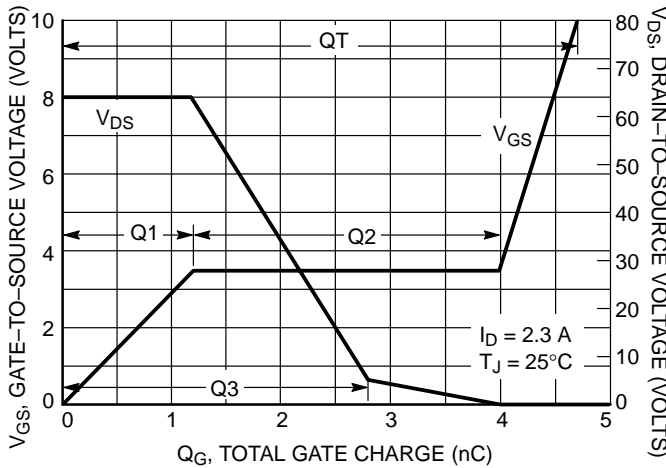

Figure 8. Gate-to-Source and Drain-to-Source Voltage versus Total Charge

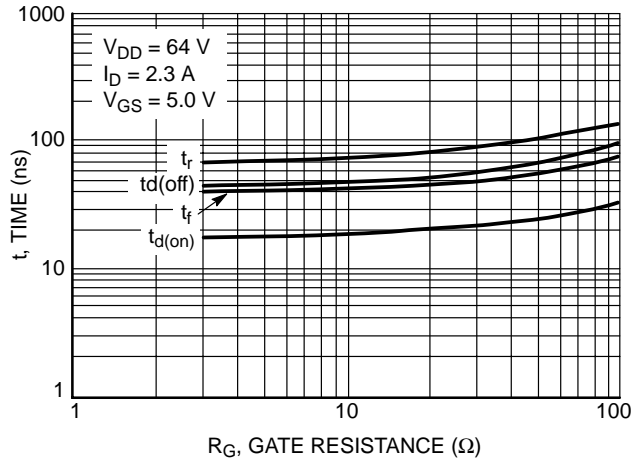

Figure 9. Resistive Switching Time Variation versus Gate Resistance

DRAIN-TO-SOURCE DIODE CHARACTERISTICS

The switching characteristics of a MOSFET body diode are very important in systems using it as a freewheeling or commutating diode. Of particular interest are the reverse recovery characteristics which play a major role in determining switching losses, radiated noise, EMI and RFI.

System switching losses are largely due to the nature of the body diode itself. The body diode is a minority carrier device, therefore it has a finite reverse recovery time, t_{rr} , due to the storage of minority carrier charge, Q_{RR} , as shown in the typical reverse recovery wave form of Figure 14. It is this stored charge that, when cleared from the diode, passes through a potential and defines an energy loss. Obviously, repeatedly forcing the diode through reverse recovery further increases switching losses. Therefore, one would like a diode with short t_{rr} and low Q_{RR} specifications to minimize these losses.

The abruptness of diode reverse recovery effects the amount of radiated noise, voltage spikes, and current ringing. The mechanisms at work are finite irremovable circuit parasitic inductances and capacitances acted upon by

high di/dt s. The diode's negative di/dt during t_a is directly controlled by the device clearing the stored charge. However, the positive di/dt during t_b is an uncontrollable diode characteristic and is usually the culprit that induces current ringing. Therefore, when comparing diodes, the ratio of t_b/t_a serves as a good indicator of recovery abruptness and thus gives a comparative estimate of probable noise generated. A ratio of 1 is considered ideal and values less than 0.5 are considered snappy.

Compared to ON Semiconductor standard cell density low voltage MOSFETs, high cell density MOSFET diodes are faster (shorter t_{rr}), have less stored charge and a softer reverse recovery characteristic. The softness advantage of the high cell density diode means they can be forced through reverse recovery at a higher di/dt than a standard cell MOSFET diode without increasing the current ringing or the noise generated. In addition, power dissipation incurred from switching the diode will be less due to the shorter recovery time and lower switching losses.

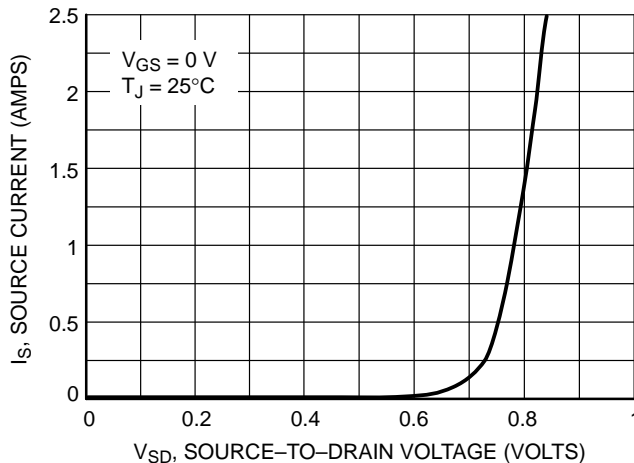

Figure 10. Diode Forward Voltage versus Current

SAFE OPERATING AREA

The Forward Biased Safe Operating Area curves define the maximum simultaneous drain-to-source voltage and drain current that a transistor can handle safely when it is forward biased. Curves are based upon maximum peak junction temperature and a case temperature (T_C) of 25°C. Peak repetitive pulsed power limits are determined by using the thermal response data in conjunction with the procedures discussed in AN569, "Transient Thermal Resistance – General Data and Its Use."

Switching between the off-state and the on-state may traverse any load line provided neither rated peak current (I_{DM}) nor rated voltage (V_{DSS}) is exceeded, and that the transition time (t_r , t_f) does not exceed 10 μ s. In addition the

total power averaged over a complete switching cycle must not exceed $(T_{J(MAX)} - T_C)/(R_{\theta JC})$.

A power MOSFET designated E-FET can be safely used in switching circuits with unclamped inductive loads. For reliable operation, the stored energy from circuit inductance dissipated in the transistor while in avalanche must be less than the rated limit and must be adjusted for operating conditions differing from those specified. Although industry practice is to rate in terms of energy, avalanche energy capability is not a constant. The energy rating decreases non-linearly with an increase of peak current in avalanche and peak junction temperature.

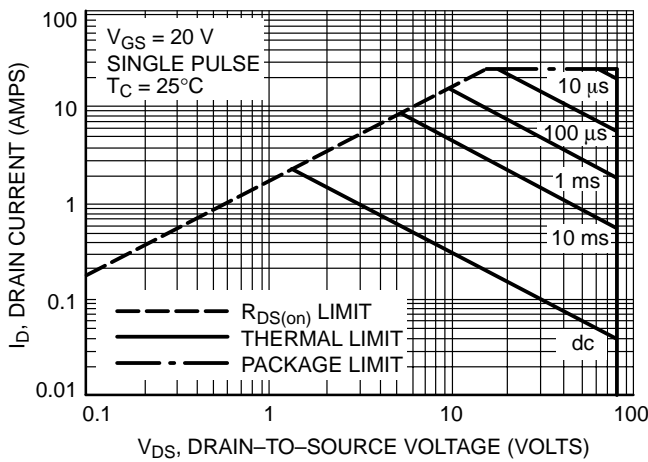

Figure 11. Maximum Rated Forward Biased Safe Operating Area

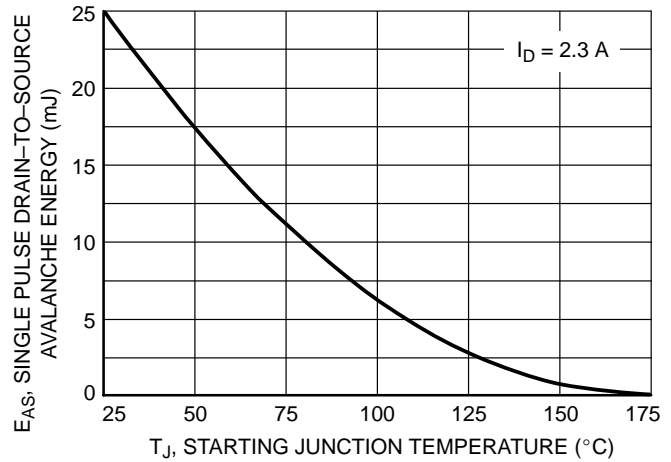

Figure 12. Maximum Avalanche Energy versus Starting Junction Temperature

NTMD3N08LR2

TYPICAL ELECTRICAL CHARACTERISTICS

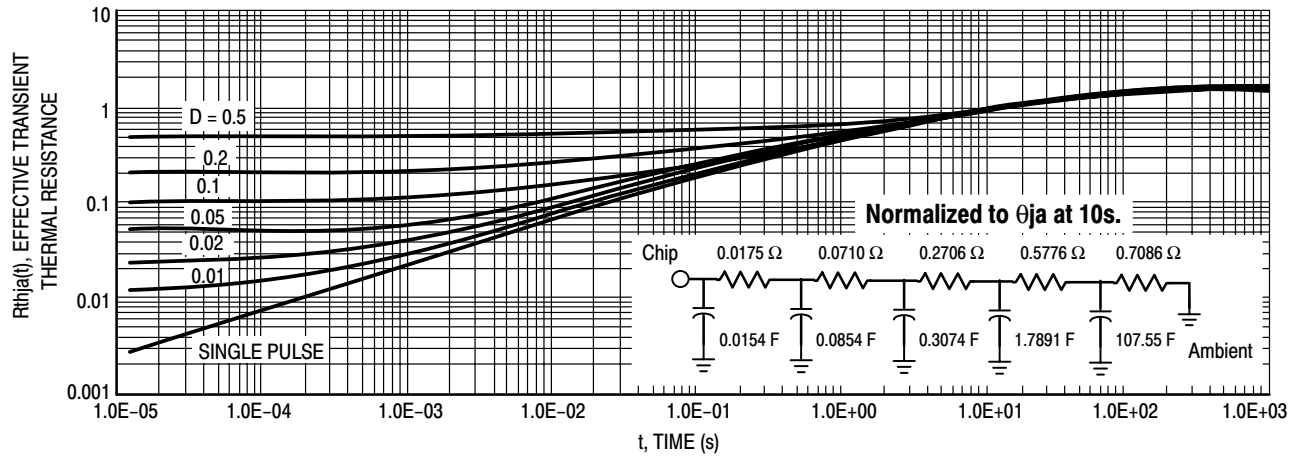

Figure 13. Thermal Response

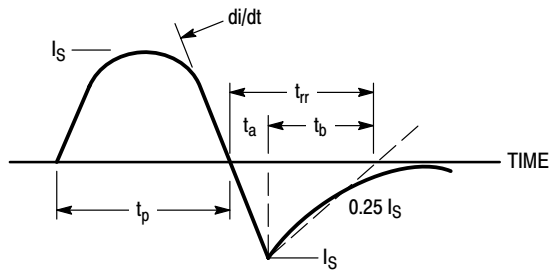

Figure 14. Diode Reverse Recovery Waveform

INFORMATION FOR USING THE SO-8 SURFACE MOUNT PACKAGE

MINIMUM RECOMMENDED FOOTPRINT FOR SURFACE MOUNTED APPLICATIONS

Surface mount board layout is a critical portion of the total design. The footprint for the semiconductor packages must be the correct size to ensure proper solder connection

interface between the board and the package. With the correct pad geometry, the packages will self-align when subjected to a solder reflow process.

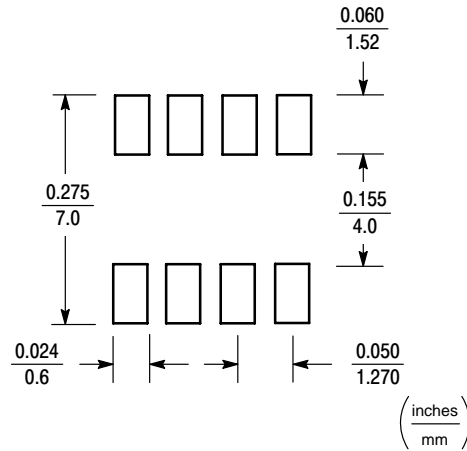

SO-8 POWER DISSIPATION

The power dissipation of the SO-8 is a function of the input pad size. This can vary from the minimum pad size for soldering to the pad size given for maximum power dissipation. Power dissipation for a surface mount device is determined by $T_{J(max)}$, the maximum rated junction temperature of the die, $R_{\theta JA}$, the thermal resistance from the device junction to ambient; and the operating temperature, T_A . Using the values provided on the data sheet for the SO-8 package, P_D can be calculated as follows:

$$P_D = \frac{T_{J(max)} - T_A}{R_{\theta JA}}$$

The values for the equation are found in the maximum ratings table on the data sheet. Substituting these values

into the equation for an ambient temperature T_A of 25°C, one can calculate the power dissipation of the device which in this case is 2.0 Watts.

$$P_D = \frac{150^\circ\text{C} - 25^\circ\text{C}}{62.5^\circ\text{C/W}} = 2.0 \text{ Watts}$$

The 62.5°C/W for the SO-8 package assumes the recommended footprint on a glass epoxy printed circuit board to achieve a power dissipation of 2.0 Watts using the footprint shown. Another alternative would be to use a ceramic substrate or an aluminum core board such as Thermal Clad®. Using board material such as Thermal Clad, the power dissipation can be doubled using the same footprint.

SOLDERING PRECAUTIONS

The melting temperature of solder is higher than the rated temperature of the device. When the entire device is heated to a high temperature, failure to complete soldering within a short time could result in device failure. Therefore, the following items should always be observed in order to minimize the thermal stress to which the devices are subjected.

- Always preheat the device.
- The delta temperature between the preheat and soldering should be 100°C or less.*
- When preheating and soldering, the temperature of the leads and the case must not exceed the maximum temperature ratings as shown on the data sheet. When using infrared heating with the reflow soldering method, the difference shall be a maximum of 10°C.

- The soldering temperature and time shall not exceed 260°C for more than 10 seconds.
- When shifting from preheating to soldering, the maximum temperature gradient shall be 5°C or less.
- After soldering has been completed, the device should be allowed to cool naturally for at least three minutes. Gradual cooling should be used as the use of forced cooling will increase the temperature gradient and result in latent failure due to mechanical stress.
- Mechanical stress or shock should not be applied during cooling.

* Soldering a device without preheating can cause excessive thermal shock and stress which can result in damage to the device.

TYPICAL SOLDER HEATING PROFILE

For any given circuit board, there will be a group of control settings that will give the desired heat pattern. The operator must set temperatures for several heating zones and a figure for belt speed. Taken together, these control settings make up a heating “profile” for that particular circuit board. On machines controlled by a computer, the computer remembers these profiles from one operating session to the next. Figure 15 shows a typical heating profile for use when soldering a surface mount device to a printed circuit board. This profile will vary among soldering systems, but it is a good starting point. Factors that can affect the profile include the type of soldering system in use, density and types of components on the board, type of solder used, and the type of board or substrate material being used. This profile shows

temperature versus time. The line on the graph shows the actual temperature that might be experienced on the surface of a test board at or near a central solder joint. The two profiles are based on a high density and a low density board. The Vitronics SMD310 convection/infrared reflow soldering system was used to generate this profile. The type of solder used was 62/36/2 Tin Lead Silver with a melting point between 177–189°C. When this type of furnace is used for solder reflow work, the circuit boards and solder joints tend to heat first. The components on the board are then heated by conduction. The circuit board, because it has a large surface area, absorbs the thermal energy more efficiently, then distributes this energy to the components. Because of this effect, the main body of a component may be up to 30 degrees cooler than the adjacent solder joints.

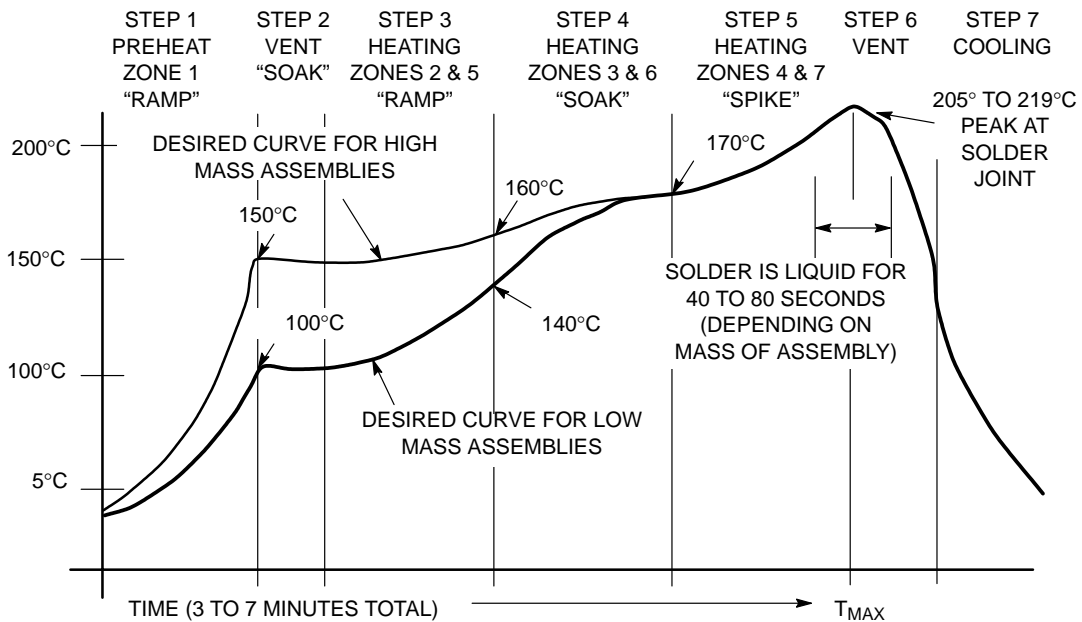
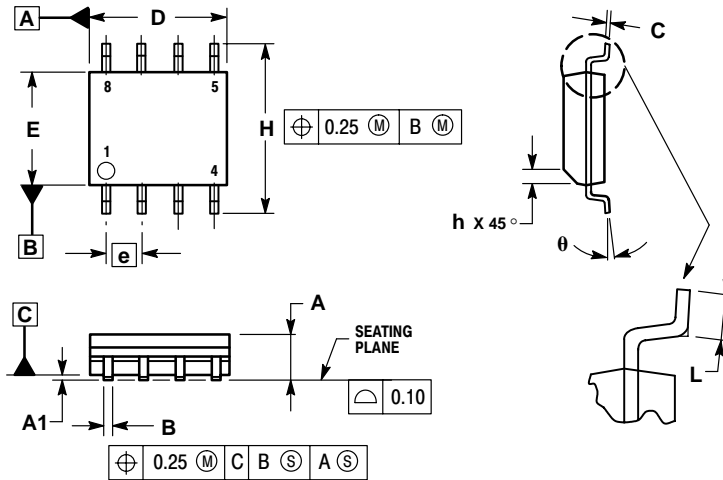

Figure 15. Typical Solder Heating Profile

NTMD3N08LR2

PACKAGE DIMENSIONS

DUAL SO-8
CASE 751-06
ISSUE T



NOTES:

1. DIMENSIONING AND TOLERANCING PER ASME Y14.5M, 1994.
2. DIMENSIONS ARE IN MILLIMETER.
3. DIMENSION D AND E DO NOT INCLUDE MOLD PROTRUSION.
4. MAXIMUM MOLD PROTRUSION 0.15 PER SIDE.
5. DIMENSION B DOES NOT INCLUDE DAMBAR PROTRUSION. ALLOWABLE DAMBAR PROTRUSION SHALL BE 0.127 TOTAL IN EXCESS OF THE B DIMENSION AT MAXIMUM MATERIAL CONDITION.

MILLIMETERS	
DIM	MIN MAX
A	1.35 1.75
A1	0.10 0.25
B	0.35 0.49
C	0.19 0.25
D	4.80 5.00
E	3.80 4.00
e	1.27 BSC
H	5.80 6.20
h	0.25 0.50
L	0.40 1.25
θ	0° 7°

STYLE 11:

- PIN 1. SOURCE 1
 2. GATE 1
 3. SOURCE 2
 4. GATE 2
 5. DRAIN 2
 6. DRAIN 2
 7. DRAIN 1
 8. DRAIN 1

Notes

Thermal Clad is a registered trademark of the Bergquist Company.

ON Semiconductor and  are registered trademarks of Semiconductor Components Industries, LLC (SCILLC). SCILLC reserves the right to make changes without further notice to any products herein. SCILLC makes no warranty, representation or guarantee regarding the suitability of its products for any particular purpose, nor does SCILLC assume any liability arising out of the application or use of any product or circuit, and specifically disclaims any and all liability, including without limitation special, consequential or incidental damages. "Typical" parameters which may be provided in SCILLC data sheets and/or specifications can and do vary in different applications and actual performance may vary over time. All operating parameters, including "Typicals" must be validated for each customer application by customer's technical experts. SCILLC does not convey any license under its patent rights nor the rights of others. SCILLC products are not designed, intended, or authorized for use as components in systems intended for surgical implant into the body, or other applications intended to support or sustain life, or for any other application in which the failure of the SCILLC product could create a situation where personal injury or death may occur. Should Buyer purchase or use SCILLC products for any such unintended or unauthorized application, Buyer shall indemnify and hold SCILLC and its officers, employees, subsidiaries, affiliates, and distributors harmless against all claims, costs, damages, and expenses, and reasonable attorney fees arising out of, directly or indirectly, any claim of personal injury or death associated with such unintended or unauthorized use, even if such claim alleges that SCILLC was negligent regarding the design or manufacture of the part. SCILLC is an Equal Opportunity/Affirmative Action Employer.

PUBLICATION ORDERING INFORMATION

Literature Fulfillment:

Literature Distribution Center for ON Semiconductor
P.O. Box 5163, Denver, Colorado 80217 USA
Phone: 303-675-2175 or 800-344-3860 Toll Free USA/Canada
Fax: 303-675-2176 or 800-344-3867 Toll Free USA/Canada
Email: ONlit@hibbertco.com

N. American Technical Support: 800-282-9855 Toll Free USA/Canada

JAPAN: ON Semiconductor, Japan Customer Focus Center
2-9-1 Kamimeguro, Meguro-ku, Tokyo, Japan 153-0051
Phone: 81-3-5773-3850
Email: r14525@onsemi.com

ON Semiconductor Website: <http://onsemi.com>

For additional information, please contact your local Sales Representative.