

NEOFIDELITY

NTP8918

High Performance, High Fidelity Power Driver Integrated Full Digital Audio Amplifier

Datasheet
ver. 1.0

CONFIDENTIAL

2020 02 28

iSweek www.isweek.cn

公司名: 深圳市工采网络科技有限公司

电话: +86-0755-83279017-8007

地址: 广东省深圳市南山区高新南一道中国科技开发院3号楼16层

传真: +86-0755-83279017-8007

邮箱: salesz@isweek.com

General Description

The NTP8918 is a single chip full digital audio amplifier including power stage for stereo amplifier system. The NTP8918 is integrated with versatile digital audio signal processing functions, high-performance, high-fidelity fully digital PWM modulator and two high-power full-bridge MOSFET power stages.

The NTP8918 receives digital serial audio data with sampling frequencies of 32kHz, 44.1kHz, 48kHz, and 96kHz. It delivers 2 x 15 watts in stereo mode without heat sink.

The NTP8918 has a mixer and Bi-Quad filters which can be used to implement the essential audio signal processing functions such as loudness control, compensation of a loud speaker response and parametric equalization.

All the functions of the NTP8918 can be controlled by internal register values via I²C host interface bus.

Package

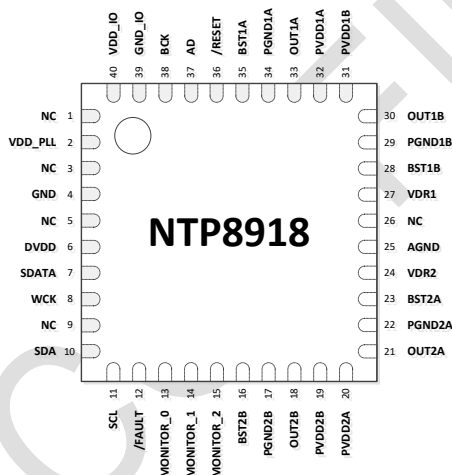

(40 pin QFN 6mm x 6mm Package)

Features

- 2 CH Stereo (15W x 2 BTL)
- Wide Operating Supply Voltage Range (5V to 28V)
- SDATA Generator (I²S Output)
- Floating Point Operation
- 32 Programmable Bi-Quad Filters
 - ✓ Speaker Compensation
 - ✓ LPF, HPF, DC Cut
 - ✓ Advanced Parametric Equalizer
- IBB(Intelligent BASS Boost)
- 3Band Dynamic Range Control
 - ✓ RS(Reinforced Sound) DRC
- Loudness Control
- Protection Circuit
 - ✓ OCP(Over Current Protection)
 - ✓ OTP(Over Temperature Protection)
 - ✓ UVP(Under Voltage Protection)
- Vol/Soft Mute/Power Meter/NS Feedback
- Smart PWM Switch On/Off
- High Efficiency
- DC Protection
 - ✓ DC Cut Filter
 - ✓ Coefficient Memory Checksum (PEQ/DRC)
 - ✓ Modulation Index Check

Applications

- OLED/UHD/FUD TV or Monitor TV
- Docking Station
- Mini-Component Audio Solution

Ordering Information

Product ID	Package Type	Pin	Size
NTP8918	QFN	40	6 x 6mm

Contact information : <http://www.n-citron.com>

Disclaimer

NeoFidelity, Inc. subject to change without notice in the product described in this datasheet including circuits, software and ICs, described herein for the purpose of improvement of design and performance. NeoFidelity, Inc. assumes no responsibilities and liabilities for the use of the product, conveys no license under any patent or copyright, and makes no warranties that the product is free from patent or copyright infringement, unless otherwise specified.

Table of Contents

1. BLOCK DIAGRAM	4
2. PIN ASSIGNMENTS	4
3. PIN DESCRIPTIONS	5
4. CHARACTERISTICS AND SPECIFICATIONS	6
4.1. Absolute Maximum Ratings	6
4.2. Recommended Operating Conditions	6
4.3. DC Electrical Characteristics	6
4.4. Performance Specification	7
4.5. Switching Characteristics – I ² C Control.....	8
4.6. Switching Characteristics – Audio Interface	8
5. I²C BUS OF NTP8918	9
5.1. General Description of I ² C Bus	9
5.1.1. Writing Operation	9
5.1.2. Reading Operation	10
5.1.3. I ² C Glitch Filter	11
5.1.4. I ² C Slave Address	11
6. CLOCK, RESET & CONTROL	12
6.1. System Clock	12
6.2. Timing Sequence 1	12
6.2.1. Power-Up & Initialization Sequence	12
6.2.2. Power-Down Sequence.....	12
6.3. Timing Sequence 2 (reference)	13
6.3.1. Power-Up & Initialization Sequence	13
6.3.2. Power-Down Sequence.....	13
6.4. Sound On/Off Sequence	13
7. AUDIO INPUT	14
7.1. I ² S	14
7.2. SDATA Generator.....	14
8. MIXER	16
9. PRE-PROCESSING	17
9.1. Bi-Quad Filter Chain.....	17
9.2. Loudness Control	18
9.3. Advanced Parametric Equalizer	18
9.4. IBB Control.....	19
10. VOLUME & DYNAMIC RANGE CONTROL	20
10.1. Master Volume Control.....	20
10.2. Channel Volume Control	20
10.3. Master Volume Fine Control	20
10.4. Mute and Soft Volume Change	20
10.5. Auto Mute	20
10.6. Dynamic Range Control	21
10.6.1. Reinforced Sound Dynamic Range Control (RS DRC).....	21
10.7. Power Meter	21
11. OUTPUT INTERFACE	22
11.1. Output Configuration	22
11.2. PWM Output Mapper.....	22
11.3. Switching Output Mode	22
11.4. Soft Start	23
12.DC PROTECTION	24
12.1 Memory Checksum	24
12.2 Modulation Index Check.....	25
12.3 Hard-wired DC cut.....	25
13.TYPICAL APPLICATION SCHEMATICS	26
14.APPENDIX	27
A. Configuration Register Summary	27
B. Configuration Register Value Reference	51
C. Typical Characteristics Graph	57
D. Package Outline.....	68

1. BLOCK DIAGRAM

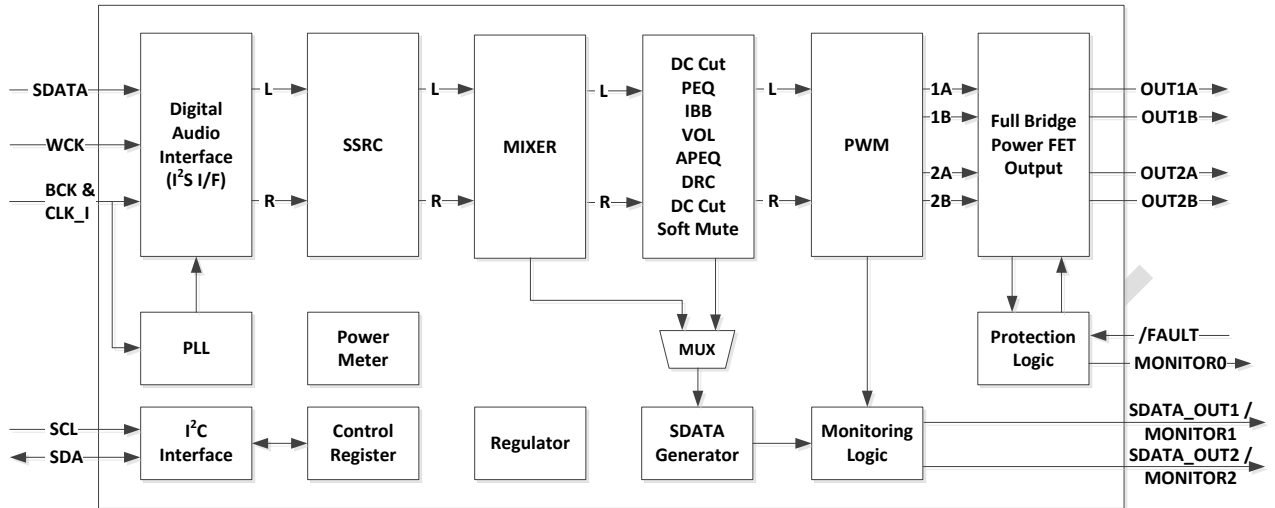

Figure 1. NTP8918 Block Diagram

2. PIN ASSIGNMENTS

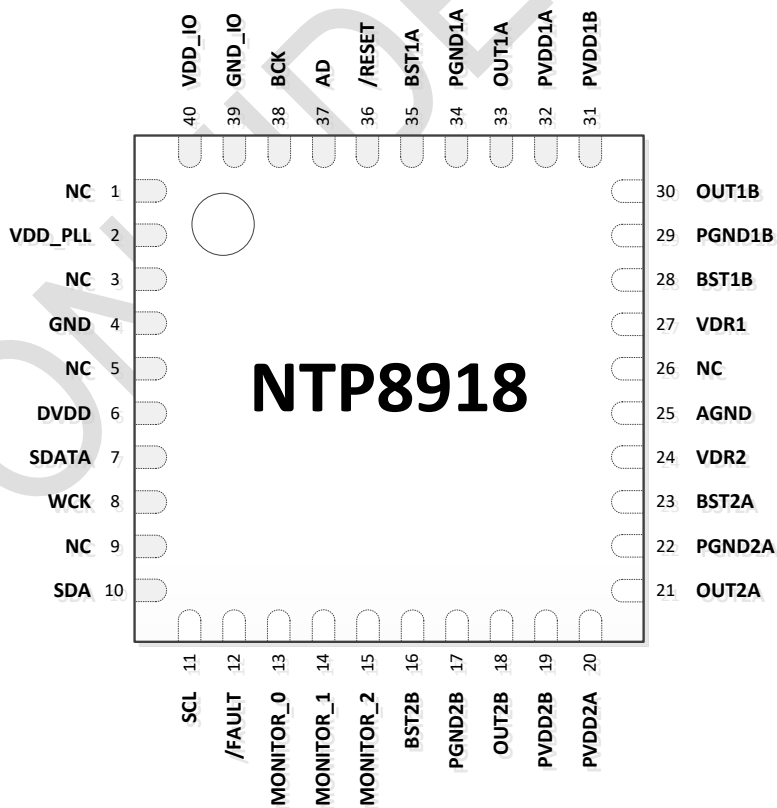

Figure 2. NTP8918 Pin Assignments

3. PIN DESCRIPTIONS

PIN	NAME	TYPE	DESCRIPTION
1	NC	-	Not connected
2	VDD_PLL	-	Not connected
3	NC	-	Not connected
4	GND	P	This pin should be connected to Ground
5	NC	-	Not connected
6	DVDD	P	Regulator output for Core block, 1.2V
7	SDATA	I	I ² S serial data input
8	WCK	I	I ² S word clock
9	NC	-	Not connected
10	SDA	I/O	I ² C data
11	SCL	I	I ² C clock
12	/FAULT	I	Active low to reset internal power stage, Pull-up
13	MONITOR_0	O	No Connection, monitoring signal out from protection logic
14	MONITOR_1	O	monitoring signal out from processor block / I ² S output (SDATA word) / I ² C slave addr2 <refer to 5.1.4>
15	MONITOR_2	O	monitoring signal out from processor block / I ² S output (SDATA word)
16	BST2B	P	Bootstrap supply, external capacitor to OUT2B is required
17	PGND2B	P	Ground
18	OUT2B	O	Power stage PWM output 2B
19	PVDD2B	P	Power supply for PWM Power stage 2B
20	PVDD2A	P	Power supply for PWM Power stage 2A
21	OUT2A	O	Power stage PWM output 2A
22	PGND2A	P	Ground
23	BST2A	P	Bootstrap supply, external capacitor to OUT2A is required
24	VDR2	P	Gate drive voltage regulator decoupling pin, capacitor to GND is required
25	AGND	P	Ground
26	NC	-	Not connected
27	VDR1	P	Gate drive voltage regulator decoupling pin, capacitor to GND is required
28	BST1B	P	Bootstrap supply, external capacitor to OUT1B is required
29	PGND1B	P	Ground
30	OUT1B	O	Power stage PWM output 1B
31	PVDD1B	P	Power supply for PWM Power stage 1B
32	PVDD1A	P	Power supply for PWM Power stage 1A
33	OUT1A	O	Power stage PWM output 1A
34	PGND1A	P	Ground
35	BST1A	P	Bootstrap supply, external capacitor to OUT1A is required
36	/RESET	I	Active low to reset NTP8918, Schmitt trigger input, pull down PAD
37	AD	I	I ² C device address selection
38	BCK	I	System master clock, Schmitt trigger input
39	GND_IO	P	Ground for digital interface I/O
40	VDD_IO	P	Power supply for digital interface I/O, 3.3V
-	Thermal Pad	P	This pad should be connected to Ground

P = Power or Ground, I = Input, O = Output, I/O = Input / Output

Table 1. NTP8918 Pin Description

4. CHARACTERISTICS AND SPECIFICATIONS

4.1. Absolute Maximum Ratings

Parameter	Reference	Rating	Unit
DVDD voltage	DGND	-0.3 ~ 1.5	V
VDD_IO voltage	GND_IO	-0.3 ~ 5.25	V
Logic input voltage	GND	-0.3 ~ 5.25	V
Logic output voltage	GND	-0.3 ~ 5.25	V
PVDDXX voltage	PGNDXX	30	V
OUTXX voltage	PGNDXX	-0.3 ~ PVDDXX	V
BSTXX voltage	OUTXX	-0.3 ~ 6.0	V
VDRX voltage	AGND	-0.3 ~ 6.0	V
Junction temperature	T _J	150	°C

4.2. Recommended Operating Conditions

Parameter	Reference	Rating	Unit
VDD_IO voltage	GND_IO	3.0 ~ 3.6	V
PVDDXX voltage	PGNDXX	5 ~ 28	V
VDRX voltage	PGNDXX	4.5 5.1 5.6	V
Ambient operating temperature	T _A	-25 ~ 85	°C
Load impedance (BTL)	Output Filter L : 10uH, C : 470nF	4 8	Ω
Load impedance (PBTL)	Output Filter L : 10uH, C : 470nF	4	Ω

4.3. DC Electrical Characteristics

Parameter	Symbol	Condition	Min	Typ	Max	Unit
Logic Block (VDD_IO=3.3V, T _A =+25°C, unless otherwise specified.)						
Input High voltage	V _{IH}	-	2.0			V
Input Low voltage	V _{IL}	-	-0.5		0.8	V
Schmitt trig. Low to High threshold point	V _{T+}	-	2		3.6	V
Schmitt trig. High to Low threshold point	V _{T-}	-	-0.5		0.8	V
Input current	I _I	V _{IN} =V _{IL} MAX, DVDD=MIN	-50			uA
		V _{IN} =V _{IH} MIN, DVDD=MIN			50	uA
Input leakage current	I _L	V _{IN} =VSS, DVDD=MIN	-10		10	uA
Output Low voltage	V _{OL}	I _{OL} = -4mA	0		0.4	V
Output High voltage	V _{OH}	I _{OH} = 4mA	2.4		3.6	V
LDO output voltage	V _{LDO}	DVDD	1.08		1.32	V
Driver Block (PVDDXX=24V, T _A =+25°C, unless otherwise specified.)						
Current consumption		VDD_IO=3.3V, No Input, No Load		23		mA
		PVDD=V, No Input, 8 Ω Load with 10uH, DBTL		30		
Peak current limit	OCP	-		5		A
Thermal shutdown temperature	OTP			150		°C
Under voltage lockout	UVP			4.1		V

4.4. Performance Specification

Parameter	Condition	Min	Typ	Max	Unit
Speaker Amplifier					
SNR	A-Weighting filter		101		dB
THD+N	1W, 1kHz		0.1		%
Cross talk	20Hz ~ 20kHz		-97		dB

CONFIDENTIAL

4.5. Switching Characteristics – I²C Control

Parameter	Symbol	Condition	Min	Max	Unit
I²C Control Port					
SCL clock frequency	F _{scl}		-	400	kHz
Hold time for START condition	T _{hdsta}		600	-	ns
Low period of the SCL clock	T _{low}		1300	-	ns
High period of the SCL clock	T _{high}		600	-	ns
Rise time of SDA and SCL signals	T _{rise}		-	300	ns
Fall time of SDA and SCL signals	T _{fall}		-	300	ns
Setup time for STOP condition	T _{susto}		600	-	ns

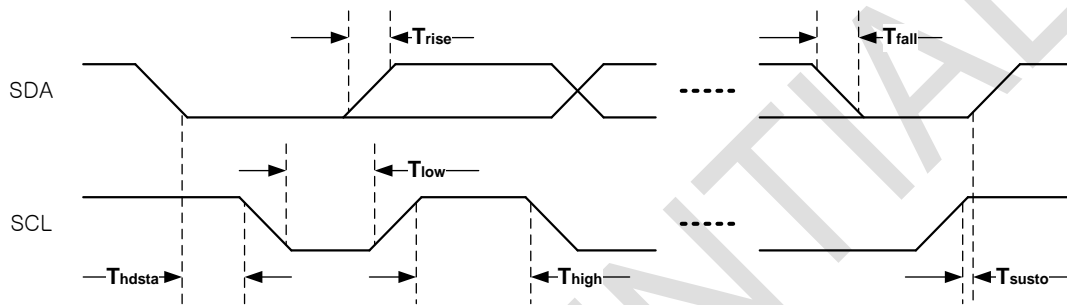

Figure 3. I²C Mode Timing

4.6. Switching Characteristics – Audio Interface

Parameters	Symbol	Min	Max	Unit
BCK high time	t _{bh}	20	-	ns
BCK low time	t _{bl}	20	-	ns
SDATA setup time before BCK rising edge	t _{ds}	10	-	ns
SDATA hold time after BCK rising edge	t _{dh}	10	-	ns
WCK setup time before BCK rising edge	t _{ws}	20	-	ns
BCK rising edge before WCK edge	t _{wh}	20	-	ns
BCK falling edge before WCK edge	t _{wl}	-20	20	ns
Rising/Falling time for BCK/WCK	t _{br} /t _{bf} /t _{wrf}	-	50	ns

* Schmitt trigger characteristics (V_{SIH} Min = 2.0V, V_{SIH} Max = 0.8V)

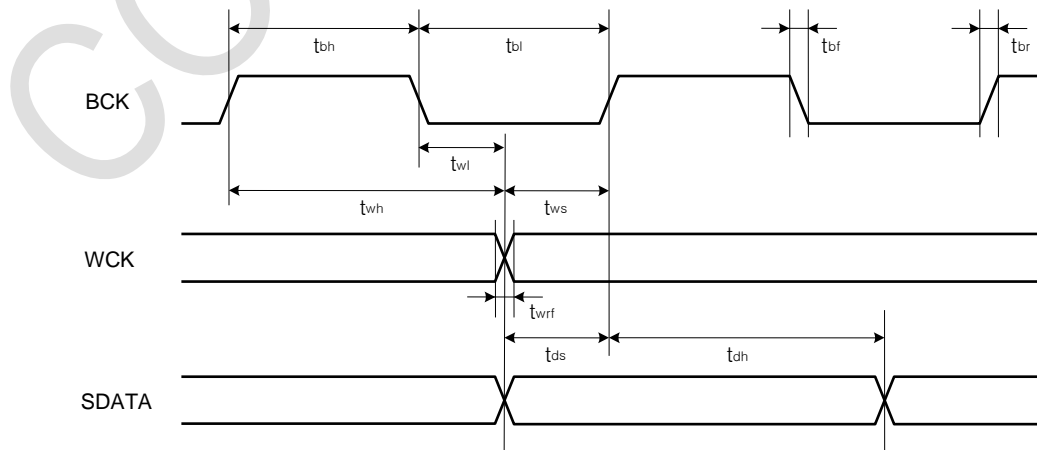

Figure 4. Audio Interface Timing

5. I²C BUS OF NTP8918

The NTP8918 uses an industry standard Inter IC Control (I²C) bus to communicate with host IC. A host IC can write or read internal registers of the NTP8918 via the I²C bus.

5.1. General Description of I²C Bus

The I²C bus uses two signal lines – a serial clock line (SCL) and a serial data line (SDA). Because the SDA line is open-drain type port, both the NTP8918 and a host IC can only drive these pins low or leave them open.

In I²C bus, a master device means the device which generates serial clock on the SCL. A slave device means the device which receives serial clock. There can be many master and slave devices on an I²C bus. But, when one master device works on the bus, the other master devices should not generate signal on the lines. These unexpected interrupts can make other slave devices to fail to communicate with the mater device.

The NTP8918 supports only slave mode of I²C bus. So, the NTP8918 always receives serial clock from a host IC. The slave mode is enough to write/read data to/from the NTP8918.

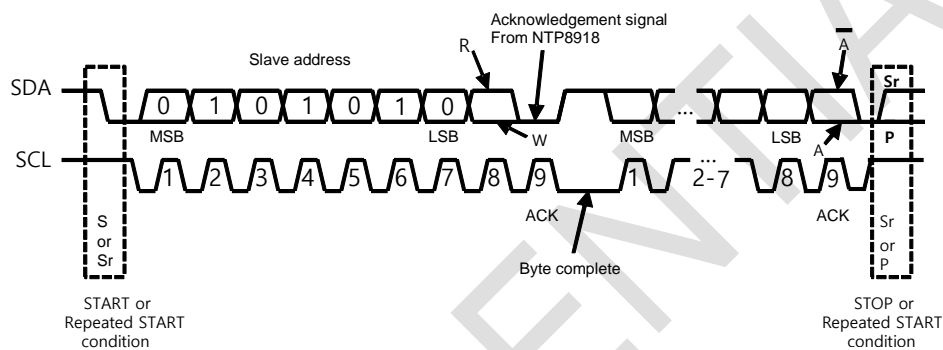

Figure 5. Basic Signaling Elements of I²C Bus

If there is no communication on I²C bus, two signal lines must keep in high state. I²C bus begins communication with the start condition and ends communication with the stop condition. The start condition can be generated by changing the SDA state high to low, during the SCL state remains in high. The stop condition can be generated by changing the SDA state low to high during the SCL remains in high state. Be aware that the stop condition always reset the internal status of I²C bus control logic. Except these two conditions, the SDA may not change during the SCL in high state. Otherwise, abnormal start or stop condition will be generated.

I²C bus transfers the MSB of a byte on 1st data slot and the LSB of a byte on 8th data slot. I²C bus checks success or fail of transfer on every 1 byte transfer. The device which found an expected data on SDA must generate acknowledgement (keep low on SDA) on 9th clock. If there is no acknowledgement on 9th clock, the device which generated a data on SDA may stop transfer. The NTP8918 will generate acknowledgement for every successful data transfer of 1 byte in write mode. But, in read mode, because data is generated by the NTP8918, the NTP8918 will not generate an acknowledgement. In this case, on the contrary, the NTP8918 will check SDA state on 9th clock that the master device received a read data properly.

Last 8th bit of the 1st byte is used to indicate whether the master device want to write or read data.

5.1.1. Writing Operation

When last 8th bit of the 1st byte is set to low state, the writing operation of I²C bus begins. The NTP8918 supports 3 kinds of writing operations which are presented on **Figure 6**.

The type presented on **Figure 6-(a)** is single byte write operation. “Sub Address” on 2nd byte means the internal register address of the NTP8918. The “Data” on 3rd byte will be written into the internal register address on “Sub Address”. If the stop condition is not generated, writing “Data” on specific “Sub Address” can be repeated like **Figure 6-(b)**. “Data #n” will be written on “Sub Address #n”.

The type presented on **Figure 6-(c)** is single byte write operation under address auto increment mode. The AIF on 1st bit of 2nd byte is the address auto increment flag. If SDA is set to high state on AIF slots, the NTP8918 writes data continuously with register addresses which are increased from initial “Sub Address” for every byte; “Data #n” will be written on “Sub Address” + n – 1. The internal address will cycle automatically.

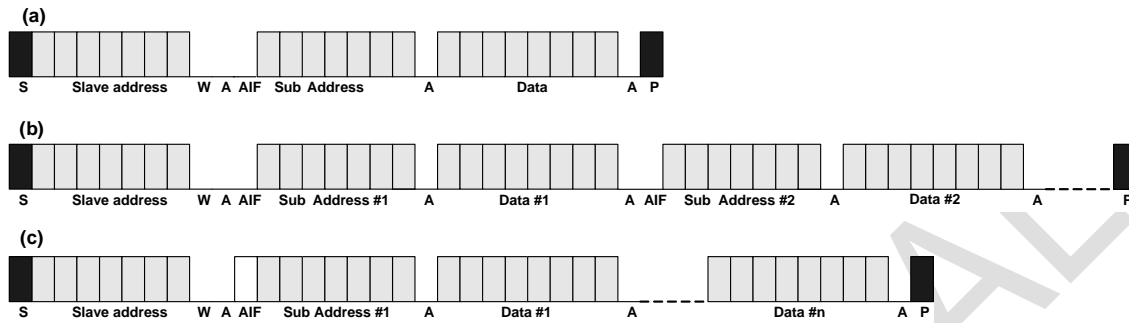

Figure 6. Single Byte Write Mode Sequence

Figure 7-(a), **Figure 7-(b)**, and **Figure 7-(c)** represent 4 byte writing operations. Coefficient mode address 0x00~0x79 are used to configure Bi-Quad filter coefficients, those are BQ, QMF_BQ, loudness filter gain, attack gain, power meter gain and PEQ/DRC checksum. The data size of these coefficients and gains is 4 byte for each. The difference between 4byte writing operation and single byte writing operation is only the size of transferring data. So, after sending “Sub Address”, 4 sequential bytes must be transferred from the MSB(most significant byte) to the LSB(least significant byte) sequence.

The type presented on **Figure 7-(c)** is quad byte write operation under address auto increment mode, AIF function. Please compare the data transfer size between **Figure 6** and **Figure 7**.

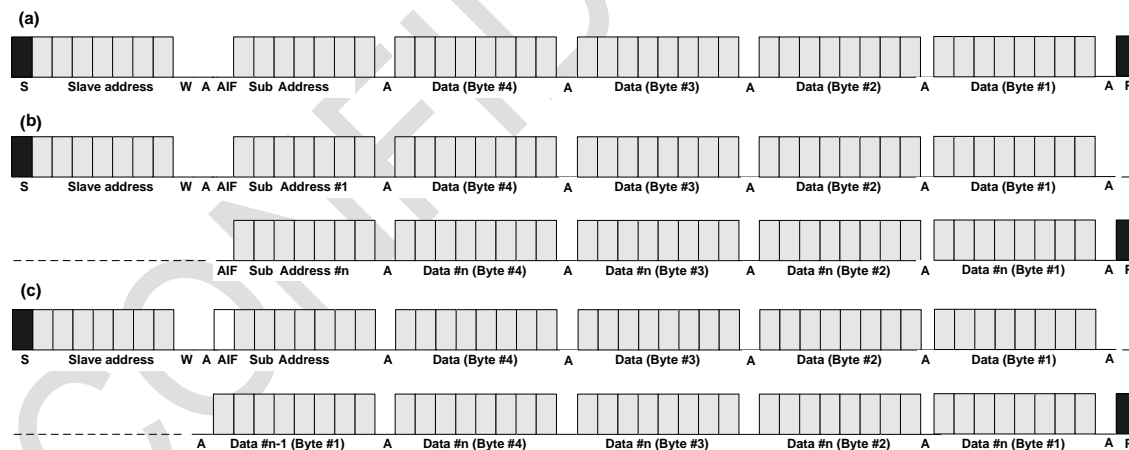

Figure 7. Quad Byte Write Mode Sequence

Each Bi-Quad filter uses 5 coefficients. Any unexpected coefficient value changes on any part of 5 coefficients can generate unstable Bi-Quad filter response. For example, if only one of 5 coefficients for a Bi-Quad filter is changed and downloaded, its combined 5-coefficient set can have unstable operation while old and new coefficients are mixed together. Therefore to prevent this kind of problem, the NTP8918 writes coefficients to coefficient registers only when the last 5th coefficients of each Bi-Quad filter is downloaded, which means all of 5 coefficients are fully ready. Please refer to 9.1 for more detailed operation.

5.1.2. Reading Operation

Figure 8-(a) represents single byte reading operation from the NTP8918. To read data from the NTP8918, generate the start condition to start transfer. After then, send “Slave Address”

with write mode flag and send the register address(Sub Address). By regenerating the start condition (Sr) again and transferring “Slave Address” with read mode flag, reading operation begins. The NTP8918 will generate data on SDA signal synchronizing with serial clocks on the SCL. Because the SDA signal is generated from the NTP8918, the master device must generate ACK on 9th slot to confirm that the master received 1 byte successfully. However, if this is just one byte reading operation, NAK (not acknowledged) signal must be generated. Then the stop condition must be generated to end transfer.

When the AIF is set to high on “Sub Address” like **Figure 8-(b)**, data will be read continuously with register addresses which are increased from initial “Sub Address” for every byte. To continue reading operation in this case, the master must generate ACK signal on every 9th slot to confirm that the master received 1 byte successfully. Otherwise, reading operation will be terminated. To end address auto increment reading operation, generate NAK on 9th slot and the stop condition.

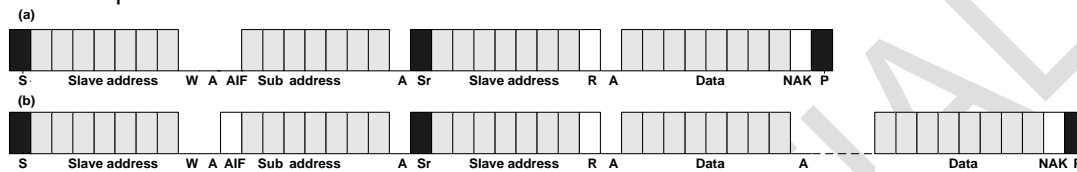

Figure 8. Single Byte Read Mode Sequence

Figure 9 represents quad byte reading operation. The difference between quad byte reading operation and single byte reading operation is only the size of receiving data. So, after sending “Sub Address”, 4 sequential bytes must be received from the MSB to the LSB sequence.

The type presented on **Figure 9-(b)** is quad byte read operation under address auto increment mode, AIF function. Please compare the data receive size between **Figure 8** and **Figure 9**.

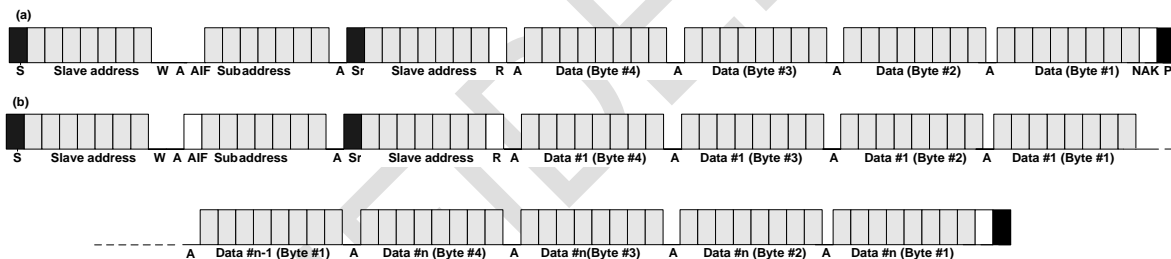

Figure 9. Quad Byte Read Mode Sequence

5.1.3. I²C Glitch Filter

To clean out the threats of noise in today’s high-speed-board system, the NTP8918 has a glitch elimination filter on the I²C ports. Glitches in the transmission lines of the I²C port can be safely removed with this function. Please refer to the register 0x66.

5.1.4. I²C Slave Address

The NTP8918 supports up to four slave addresses. A master device sends the target slave address on the 1st byte. MSB 7 bits of the 1st byte data are used for the slave address. So, four NTP8918 can be connected to the same MCU at the same time. For multi-chip operation, use the proper I²C slave address according to AD pin and the initial state of MONITOR_1 pin as shown in **Table 2**.

		MONITOR_1 Pin		
Pin name	Value	Pull-down ('L')	Pull-up ('H')	No pd / pu (default: 'L')
AD	0	Addr : 0x54	Addr : 0x58	Addr : 0x54
	1	Addr : 0x56	Addr : 0x5A	Addr : 0x56

Table 2. I²C Slave Address

6. CLOCK, RESET & CONTROL

6.1. System Clock

The internal system clock of the NTP8918 is generated from an external master clock by the on-chip PLL. The NTP8918 supports external master clock frequency from 2.048MHz to 24.576MHz. For proper operation, the registers for the PLL should be set correctly according to master clock frequency (Address 0x02).

6.2. Timing Sequence 1

For proper power up, initialization and power down of the NTP8918, it is recommend to use the following sequence as shown in **Figure 10**.

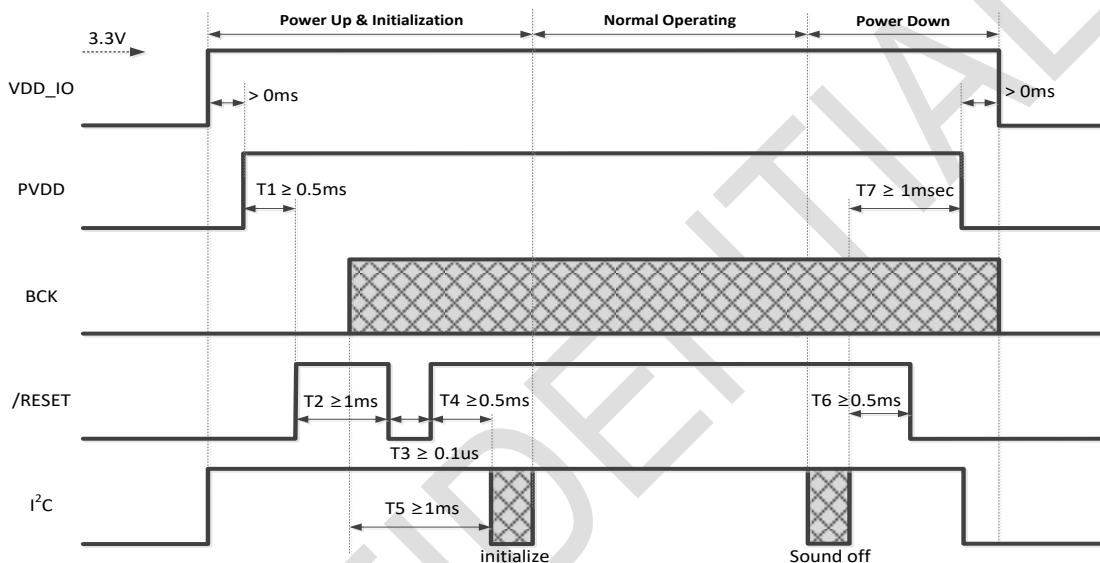

Figure 10. Timing Sequence 1

6.2.1. Power-Up& Initialization Sequence

- 1) Ramp up VDD_IO to at least 3.3V.
- 2) Ramp up PVDD.
- 3) After 0.5msec ($T1 \geq 0.5\text{msec}$), drive /RESET = High, and then wait for at least 1msec ($T2 \geq 1\text{msec}$).
- 4) Hold /RESET Low for at least 0.1usec ($T3 \geq 0.1\text{usec}$)
- 5) Drive /RESET = High, and then wait for at least 0.5msec for I2C communication ($T4 \geq 0.5\text{msec}$).
- 6) BCK signal should arrive at least 1msec before I2C initialization sequence ($T5 \geq 1\text{msec}$).
- 7) Execute both amp initialization sequence (e.g. clock, volume, DRC, PEQ setup) and sound on sequence.

6.2.2. Power-Down Sequence

- 1) When both DC and AC power are off, make sure to execute sound off sequence.
- 2) Switch /RESET to Low at least 0.5 msec after sound off sequence ($T6 \geq 0.5\text{msec}$).
- 3) Ramp down PVDD at least 1 msec after sound off sequence ($T7 \geq 1\text{msec}$).
- 4) After I²C is Low, ramp down VDD_IO.

6.3. Timing Sequence 2 (reference)

Following figure illustrates another timing sequence, which is conforming to the legacy reset timing.

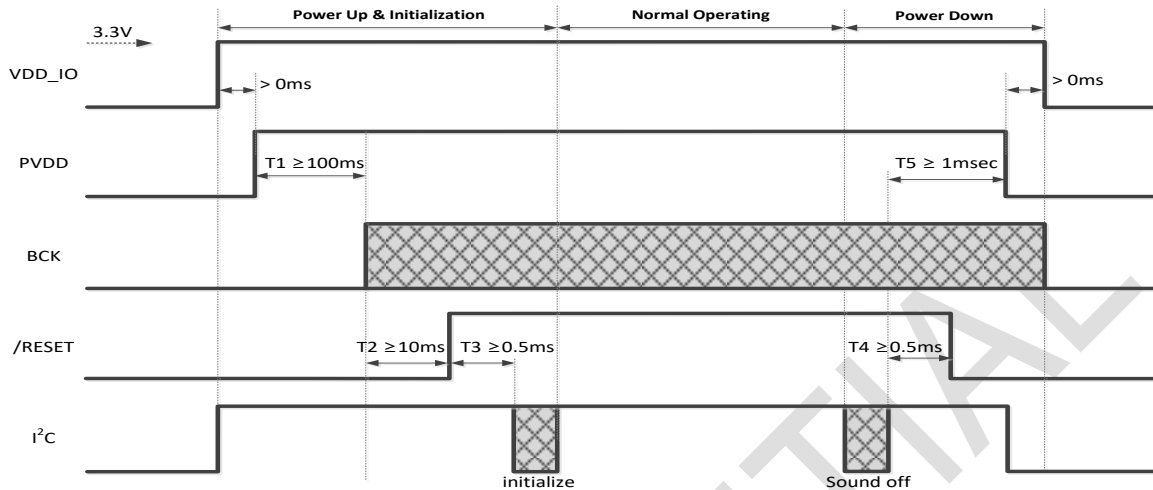

Figure 11. Timing Sequence 2

6.3.1. Power-Up & Initialization Sequence

- 1) Ramp up VDD_IO to at least 3.3V.
- 2) Ramp up PVDD.
- 3) Drive BCK signal at least 100ms after PVDD ($T1 \geq 100\text{msec}$).
- 4) At least 10ms after BCK, Drive /RESET = High ($T2 \geq 10\text{msec}$).
- 5) Wait for at least 0.5msec for I²C communication ($T3 \geq 0.5\text{msec}$) and keep the status.
- 6) Execute both amp initialization sequence (e.g. clock, volume, DRC, PEQ setup) and sound on sequence.

6.3.2. Power-Down Sequence

- 1) When both DC and AC power are off, make sure to execute sound off sequence.
- 2) Switch /RESET to Low at least 0.5 msec after sound off sequence ($T4 \geq 0.5\text{msec}$).
- 3) Ramp down PVDD at least 1 msec after sound off sequence ($T5 \geq 1\text{msec}$).
- 4) After I²C is Low, ramp down VDD_IO.

6.4. Sound On/Off Sequence

For proper sound on/off of NTP8918, use the following sequence as shown in Figure 12.

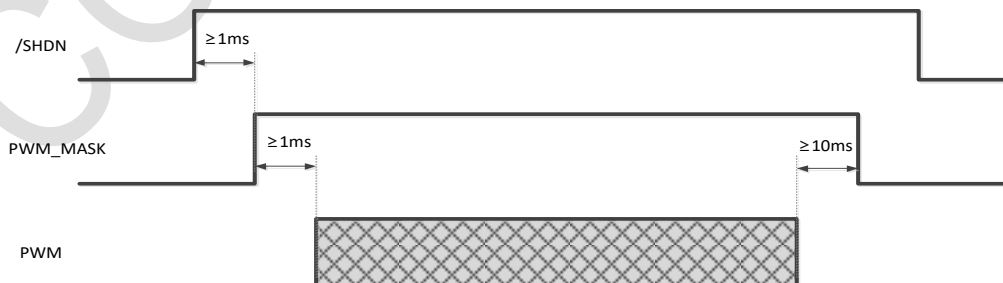

Figure 12. Sound On & Off Sequence

To prevent pop noise when enabling or disabling the amplifier, the above sequences are recommended.

7. AUDIO INPUT

7.1. I²S

NTP8918 receives audio data through digital audio interface. There is a standard digital audio interface - the Inter-IC Sound (I²S) Interface.

This interface uses 2 clock lines and 1 data line to receive the audio data. One of these clock lines is WCK. A period of WCK is same with sampling period of audio data i.e. 64bits (32bits for each channel). One of the main functions of WCK defines the channels, the low state of WCK indicates the 1st channel i.e. left channel and the high state indicates the 2nd channel i.e. right channel. This feature enables the clock receiving device to synchronize the data word-wise for transmitting or receiving from clock generating device.

The other clock line is BCK. This clock line is used to synchronize the bit-wise data. The number of BCK clock during one WCK period is 64. The name of data transfer line is SDATA. The data being synchronized with BCK must be loaded on this line. The NTP8918 receive data on the rising edge of BCK. The bit range for I²S is predefined.

The NTP8918 can only work as a slave. In slave mode, the NTP8918 receives WCK and BCK from external source. Please refer the following **Figure 13**.

7.2. SDATA Generator

The SDATA generator of NTP8918 sends I²S out signals. In order for SDATA out process to function stably, the falling of BCK should either synchronize or occur ahead of falling or rising of WCK.

Refer to the register address 0x76 and 0x7C in the **Appendix A** and refer to the **4.6. Switching Characteristics – Audio Interface**.

SDATA Generator (Sdata out)	Register value
	0x0F
Register Address 0x76	Sdata out => Monitor 1 pin

Table 3. SDATA Generator Control

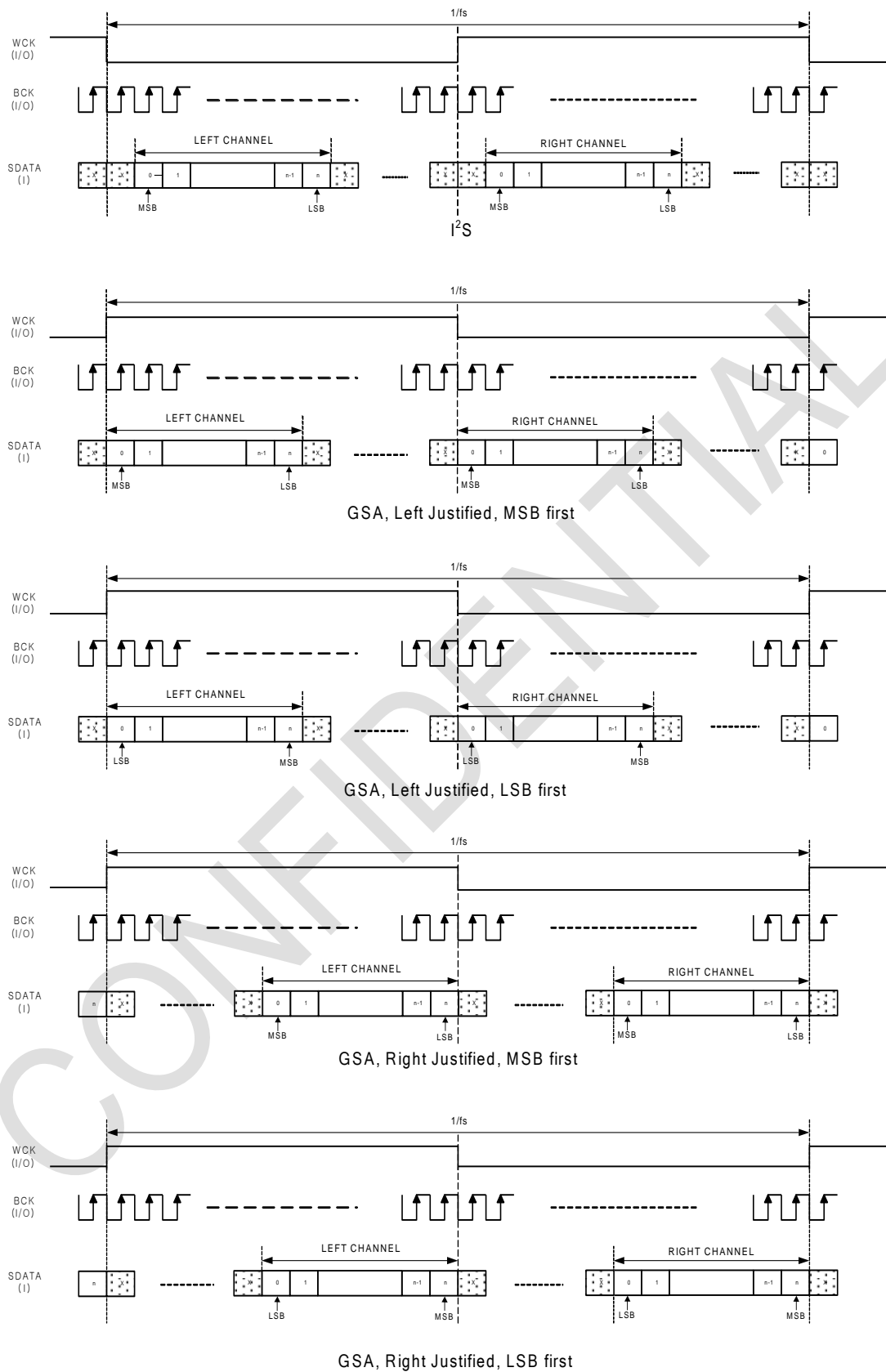

Figure 13. I²S Audio Interface Format

8. MIXER

Channel mixer can be used in lots of application needs like pseudo stereo and etc. User can mix input channels into each output channels with designated gains and polarity. Step size of mixer gain is variable according to the gain level as shown below.

Volume Range (dB)	Step (dB)
+18 ~ +6	1
+5.5 ~ -5.5	0.5
-6 ~ -32	1
≤ 32	-∞

Table 4. Variable Step Mixing Gain

In total, 4 mixing gain coefficients denoted as M00, M01, M10 and M11 are defined as shown in the equation below. Each Mxx stores volume value in dB scale, and the number values versus gain in dB are shown in the **Appendix B**. By default, each input channel connected to each output channel directly; M00 and M11 are set as 0 dB in plus polarity, M01 and M10 are set as -∞dB.

$$[\text{Output Channels}] = [\text{Mixer Matrix}] \times [\text{Input Channels}]$$

$$\begin{bmatrix} \text{CH1 OUT} \\ \text{CH2 OUT} \end{bmatrix} = \begin{bmatrix} \text{M00} & \text{M01} \\ \text{M10} & \text{M11} \end{bmatrix} \cdot \begin{bmatrix} \text{CH1 IN} \\ \text{CH2 IN} \end{bmatrix}$$

Figure 14. Serial Mixer Matrix

In order to load mixer coefficients into internal memory, send the index value in the gain value table to the register address 0x03~0x06. Each address matched to M00, M01, M10 and M11 sequentially.

9. PRE-PROCESSING

9.1. Bi-Quad Filter Chain

The Bi-Quad filter means 2nd order IIR filter. The NTP8918 implemented a serial chain of Bi-Quad filters with proprietary floating point operation schemes. The Bi-Quad filter chains can be used in various purposes; loudness control, parametric EQ, loud-speaker EQ, APEQ and etc. The Bi-Quad filter structure is shown in **Figure 15**.

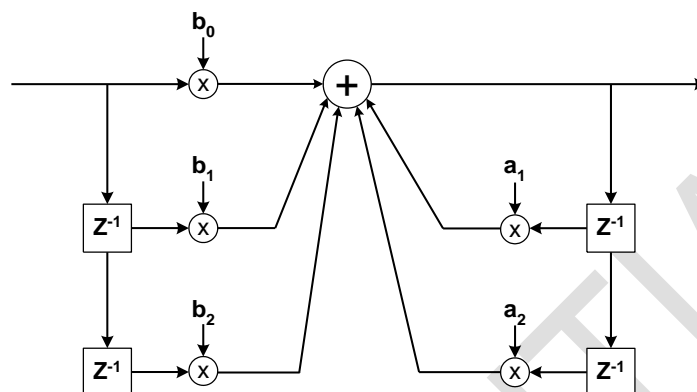

Figure 15. Bi-Quad Filter Structure

Sixteen Bi-Quad filters are linked serially for one channel. The Bi-Quad filters can be configured differently for each filter. As shown in **Figure 16**, first three filters can be used for loudness control, last six filters for APEQ control.

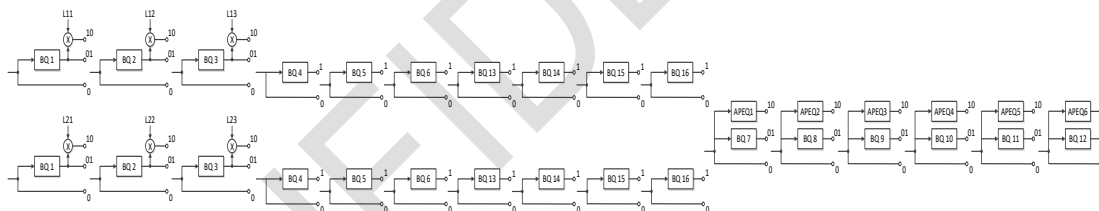

Figure 16. Bi-Quad Filter Chain

Filter coefficients are 32-bit floating point numbers and can be downloaded thru I²C interface. To download Bi-Quad filter coefficients to the NTP8918, select download channel by using CH flag in register address 0x7E first. Then, write actual coefficient values to register addresses, from 0x00 to 0x79 in the coefficient register addresses.

The coefficient mode register addresses from 0x00 through 0x04 designate the five coefficients of the first Bi-Quad (BQ1) and represent coefficients b0, b1, b2, a1, a2 respectively. The coefficient mode register addresses from 0x05 through 0x09 designate coefficients of the 2nd Bi-Quad (BQ2) filter, and so on. The enable/disable operation of these Bi-Quad filters can be made by using BQF flag in register addresses of 0x0E~0x15.

Coefficient Mode register	0x00 ~ 0x04	0x05 ~ 0x09	0x0A ~ 0x0E	0x0F ~ 0x13	0x14 ~ 0x18	0x19 ~ 0x1D	
When system address 0x7E = 0x01 0x7E = 0x02	BQ1 of CH1/2	BQ2 of CH1/2	BQ3 of CH1/2	BQ4 of CH1/2	BQ5 of CH1/2	BQ6 of CH1/2	
Coefficient Mode register	0x1E ~ 0x22	0x23 ~ 0x27	0x28 ~ 0x2C	0x2D ~ 0x31	0x50 ~ 0x52	0x5C ~ 0x60	0x61 ~ 0x65
When system address 0x7E = 0x01	BQ7	BQ8	BQ9	BQ10	Loudness Gain	BQ11	BQ12
Coefficient Mode register	0x66 ~ 0x6A	0x6B ~ 0x6F	0x70 ~ 0x74	0x75 ~ 0x79			
When system address 0x7E = 0x01	BQ13	BQ14	BQ15	BQ16			

Coefficient Mode register	0x00 ~ 0x05	0x06 ~ 0x0B	0x0C ~ 0x11	0x12 ~ 0x17	0x1F ~ 0x24
When system address 0x7E = 0x08	Coefficient 0 of APEQ 1 ~ 6	Coefficient 1 of APEQ 1 ~ 6	Coefficient 2 of APEQ 1 ~ 6	Coefficient 3 of APEQ 1 ~ 6	Coefficient 4 of APEQ 1 ~ 6

Table 5. Address of Coefficients for Bi-Quad Filter Chain

9.2. Loudness Control

The NTP8918 provides loudness control function using coefficient values. Loudness control means the compensation of frequency characteristics in low volume level to fit the acoustic characteristics of human ears.

There are 3 gains for loudness control which are applied equally over two channels. To download a loudness gain, the page flag register 0x7E should be set as 0x01 or 0x03.

Loudness Gains of CH1/CH2	Coefficient Mode Register Address		
	0x50	0x51	0x52
Register Address 0x7E= 0x01	L1	L2	L3

Table 6. Address for Loudness Gain

9.3. Advanced Parametric Equalizer

The NTP8918 has a new scheme for APEQ function using coefficient values. APEQ function means the compensation of frequency characteristics based on input signal level to fit the acoustic characteristics of human ears.

APEQ needs a Bi-Quad filter coefficient and five additional coefficients, which comprise a gain coefficient and a threshold coefficient. To download each coefficient, the page flag register 0x7E should be set as same in the case of downloading the filter coefficients. The coefficient values are applied for both channel 1 and 2.

APEQ Coefficient of CH1/CH2	Coefficient Mode Register Address				
	0x00 ~ 0x05	0x06 ~ 0x0B	0x0C ~ 0x11	0x12 ~ 0x17	0x1F ~ 0x24
Register Address 0x7E = 0x08 case	Coefficient 0 f(Gain)	Coefficient 1 f(Gain)	Coefficient 2 f(Gain)	Coefficient 3 f(Gain)	Coefficient 4 f(Threshold)

Table 7. Address for APEQ Coefficient

9.4. IBB Control

IBB (Intelligent BASS Boost) enriches the sound of low frequency of audio signal without clipping and distortion. IBB is to compensate the characteristics of human loudness perception. For instance, when the volume level is low, the gain of the low frequency band is boosted. On the other hand, when the volume level closes to the maximum, the gain can be minimized to avoid sound clipping. All these scenarios can be set by user by selecting up to four inflection points in the volume-gain curve. While applying the adaptive gain control according to the volume, enhanced bass sound is to be reproduced without sound clipping at the high volume level.

The gain boosting depending on volume level can be changed by rewriting the IBB parameter table which consists of 5 volume levels, 5 gain levels, and 4 slopes. In order to access the parameter table, two registers (Address 0x31 and 0x32) are used. The first register (Address 0x31) contains the index of the corresponding parameter, and the second register (Address 0x32) contains the value of the indexed parameter. IBB calculates adaptive gains based on the parameter table whenever the volume level is changed.

CONFIDENTIAL

10. VOLUME & DYNAMIC RANGE CONTROL

Master and channel volumes of the NTP8918 are independently controlled and softly changed. The register address 0x0C is the master volume control that affects both channels simultaneously and the addresses 0x17 and 0x18 correspond to the channel volume control register for channel 1 and 2 respectively.

The possible maximum gain is +48.375dB with using master volume fine control, master volume and channel volume because the master volume applies the gain to an input signal independent from a channel volume. However, in such a case, a clipping might occur to prevent a signal overflow error if the magnitude of the input signal is large enough to exceed 0dB under the combined volume setting.

10.1. Master Volume Control

By setting volume control register (Address 0x0C), master volume is controlled from negative infinity through 0dB with selectable step size as follows. For details on the master volume setting, see the register value table shown in **Appendix B**.

Step	Range
0.5 dB	0 ~ -125 dB

Table 8. Level Dependent Master Volume Steps

10.2. Channel Volume Control

By setting volume control registers (Address 0x17 and 0x18), channel volumes are independently controlled from negative infinity through +48dB with two selectable step sizes as described below, and in the **Appendix B**, exact values for channel volume setting are described.

Step	Range
0.5 dB	+48 ~ -79 dB

Table 9. Level Dependent Channel Volume Steps

10.3. Master Volume Fine Control

Fine control for master volume is possible (+0.125dB step up to maximum +0.375dB boost). Refer the register address 0x16 in the **Appendix A**.

10.4. Mute and Soft Volume Change

The NTP8918 enters mute state by setting soft mute flag of register address 0x33. Soft mute is implemented so that the volume gradually increases or decreases when mute is turned off or on respectively. Also the soft mute speed and soft volume change speed rates are programmable. Designers can minimize the pop noise by controlling the soft mute speed and volume change intervals. Refer SM flag of register address 0x33 and SVI flag of register address 0x30.

10.5. Auto Mute

The NTP8918 can mute the sound automatically when the level of input audio signal is lower than the register-controlled threshold value. The mute can be done by PWM switching with 50% duty ratio in AD mode or MLP width high in D-BTL mode as shown in Figure 20. Auto mute is supported for internal channels 1 and 2 after 2x2 mixer block. Refer register address 0x3A.

10.6. Dynamic Range Control

NTP8918 has a new scheme for dynamic range control, which comprise a high band DRC, a low band DRC, a sub band DRC and a post DRC. The input data is filtered by HPF, LPF and SPF, and then processed by H-DRC, L-DRC and SDRC respectively. Three processed results are merged and followed by post DRC, which produces the output data with the fully controlled dynamic range. For detailed setting of the DRC registers, please refer to the register addresses in **Table 10**.

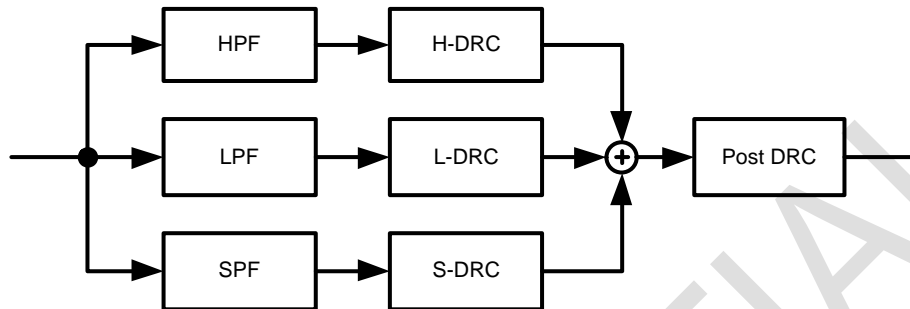

Figure 17. Block Diagram of Dynamic Range Control

3B' DRC Coefficient Mode Register	0x32 ~ 0x36	0x37 ~ 0x3B	0x3C ~ 0x40	0x41 ~ 0x45	0x46 ~ 0x4A	0x4B ~ 0x4F
Register Address 0x7E = 0x03	LPF1 of L-DRC	LPF2 of L-DRC	HPF1 of H-DRC	HPF2 of H-DRC	SPF1 of S-DRC	SPF2 of S-DRC

Table 10. Coefficient Register Map for Dynamic Range Control

10.6.1. Reinforced Sound Dynamic Range Control (RS DRC)

RS DRC controls its gain based on RMS (Root-Mean Square) level detection. When DRC controls its gain according RMS level detection, the gain transition tends to be more smooth and natural due to averaging function of RMS level detection. Thus, RS DRC gives more natural sound from the point of human perception of loudness, whereas gain control based on peak level provides tighter peak control and better reliability for speakers. Users can freely choose either of the DRC types depending on their needs by setting registers properly in the NTP8918.

10.7. Power Meter

The power meter measures the energy of the internally processed signal which is specified through register address 0x2E. And the measured value can be read through register address 0x2F. (refer to the **Table 21. Power Meter Reading Table**)

Because audio signals swing very rapidly in process of time, a user can use the power meter gain to get stable value of energy. The more power meter gain approaches to maximum value, the more value of energy changes slowly.

Power meter gain is 32-bit floating point numbers and can be downloaded thru I²C interface. To download power meter gain, page flag register 0x7E should be set 0x01 or 0x03. And then write gain value to coefficient mode address 0x58.

11. OUTPUT INTERFACE

11.1. Output Configuration

The output of the NTP8918 has various options. To produce proper output signal, register 0x34, 0x35, 0x3E, 0x3F and 0x43 should be set to appropriate values.

11.2. PWM Output Mapper

Any internal channel that produces a PWM output can be assigned to any PWM output hardware port (or pin) by mapping output port register. This feature is very helpful for the hardware designer because it can relieve difficulties in the power stage signal routing and channel assignment if the output channel order is fixed. See the register address 0x3E and 0x3F in the **Appendix A**.

11.3. Switching Output Mode

There are two selectable switching output modes in the NTP8918. The difference between two output modes lies in the relationship of the relative signal pattern between PWM OUTxA and PWM OUTxB for a channel x. The first one is called as AD mode. This AD mode can be applied to both half bridge and full bridge output stage.

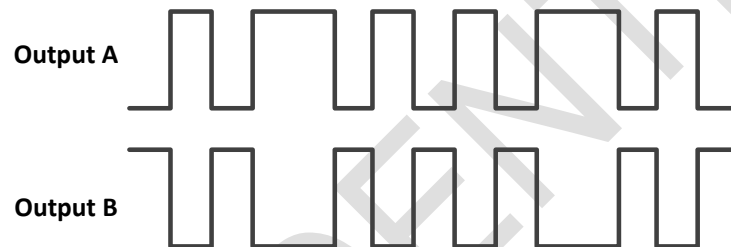

Figure 18. PWM Output Signals in AD Mode

AD asynchronous pair means the normal AD mode PWM output. In other words, A output and B output of each PWM output pair are mutually complementary. In the case of AD synchronous pair, A output and B output is perfectly identical, and its relation is not complementary. This is useful in some special case including single-ended power stage design.

The other one is called as NTX (Neo Trinity Amplification), which is D-BTL mode. This mode is applied only for BTL, and its operation is dynamically-biased BTL, compared to the normal BTL. An example of output signals in D-BTL mode is shown in **Figure 19**.

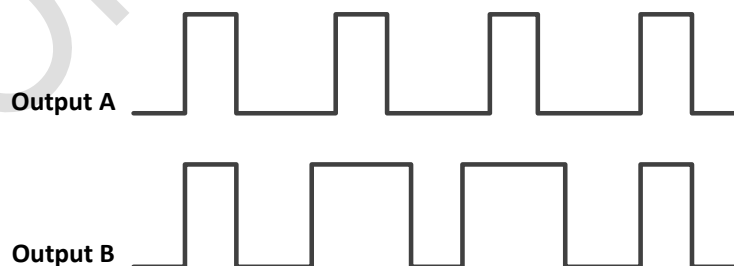

Figure 19. PWM Output Signals in D-BTL Mode

The MLP (Minimum Linear Pulse Length) parameter is an important characteristic in D-BTL mode. MLP defines the minimum pulse length that can guarantee a linear relationship between the input and output pulse length. Generally, the width of the output pulse is proportional to that of the input pulse. However, as the width of input pulse becomes narrower, such linear relation is not maintained due to the characteristic of a power device. The minimum MLP value is preferred as long as linear relationship between the input and the

output pulse is satisfied. In addition, in terms of power consumption, a minimal MLP value is preferred.

This compensation is illustrated in **Figure 20**.

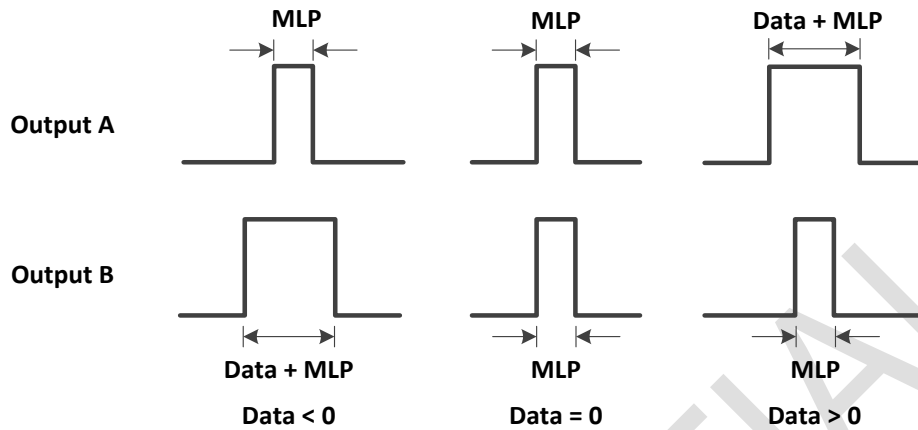

Figure 20. Compensation by MLP

11.4. Soft Start

The soft start reduces pop noise by controlling rapidly increased energy of PWM in AD mode. To begin soft start operation, PWM soft start enable register (address 0x4A: PSE) should be set to high, and then PWM switching on/off register (address 0x34: POF) should be set to low. The duty ratio of PWM output increases from 127:1 (Low:High) to 50:50 (Low:High). Step repeat time register (address 0x4A: SRT) means repeat number of PWM output. Soft start operation with 17 repetitions is shown in the **Figure 21**.

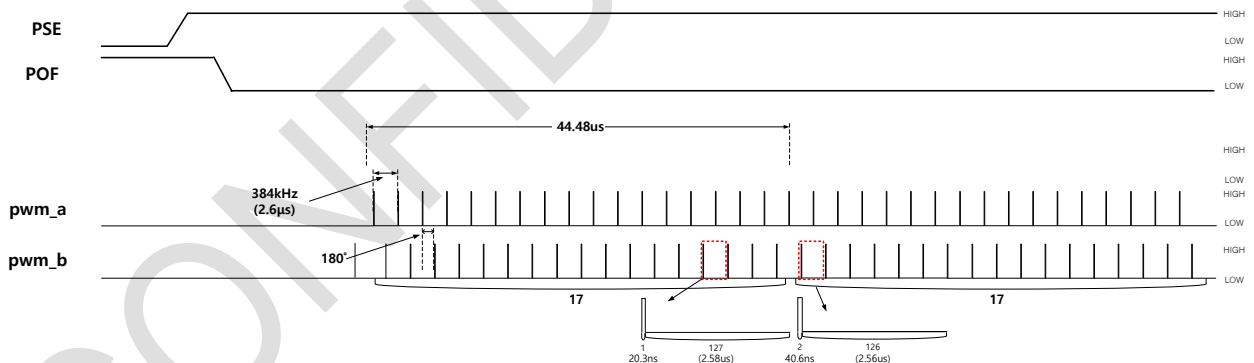

Figure 21. Soft Start Operation Timing

12.DC PROTECTION

This DC protection block prevents the system from outputting DC signal, which can cause a speaker unit burnt. Three sub functions are employed to prevent DC output, which are monitoring a memory checksum, observing a modulation index, and cutting DC output via hard-wired filters. Except for the hard-wired DC cut filter, the other two blocks only reports the error status, and external MCU may reset the amplifier chip by setting the DC soft reset register to high.

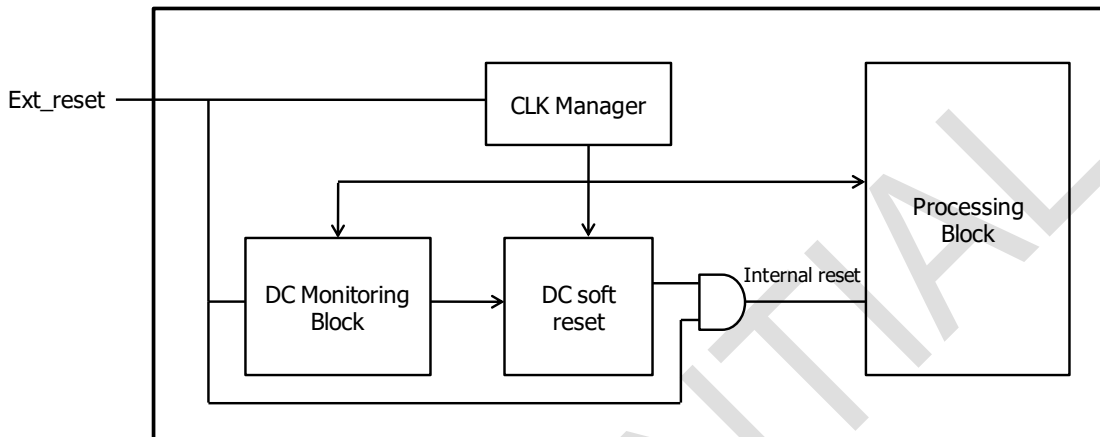

Figure 22. Block Diagram for DC PROTECTION

12.1 Memory Checksum

While initializing the system, the checksum data of coefficients are downloaded from the external MCU from the address 0x53 through 0x5A. This memory checksum block compares the checksum data of current memory block and the checksum data at the initial time. If there happens a discrepancy between two values due to some memory fault, the error flag of address 0x5B is set to high. The external MCU can monitor this error flag and reset the chip by setting the DC soft reset to high at address 0x52. This DC soft reset will initialize the whole chip, and initialization process of the memory should be done thereafter.

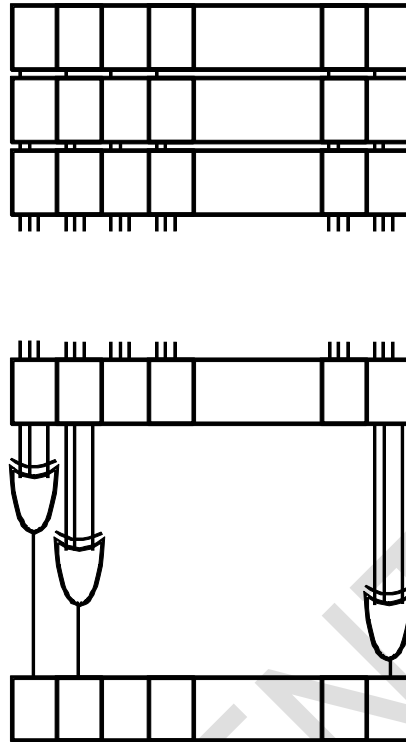

Figure 23. Structure of Memory Checksum

12.2 Modulation Index Check

When there is a DC component in the output, the modulation index tends to stay over or under certain value. The modulation index check block constantly monitors the PWM modulation index, and if the index value continues to stay over or under certain period of time, it sets modulation index error flag of address 0x5B to high. The external MCU can monitor this error flag and reset the chip by setting the DC soft reset the register value of address 0x52 to high. The PWM modulation duty at address 0x51 can be set to decide the level of DC monitoring.

12.3 Hard-wired DC cut

The hard-wired DC cut filters prevent the system from outputting the signal of less than 1Hz frequency. The hard-wired DC cut filters exist in the Bi-Quad filter chain.

13.TYPICAL APPLICATION SCHEMATICS

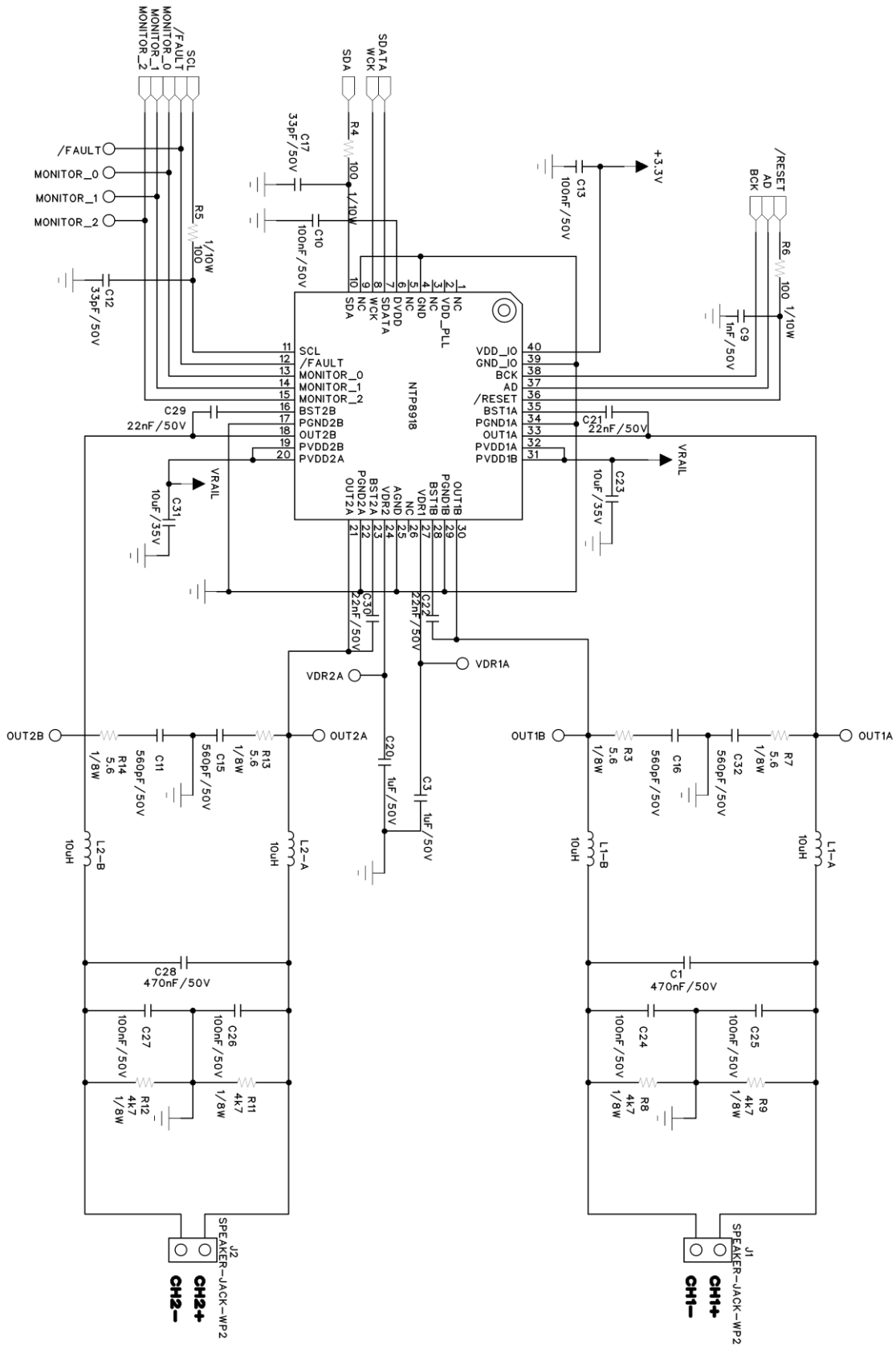

14.APPENDIX

A. Configuration Register Summary

Addr 0x00 : Audio Input Format

Bit	7	6	5	4	3	2	1	0
Name	X	X	X	X	X	X	X	INS

Name	Description	Value	Meaning	Ref.
INS	Input format	b'0	I ² S, slave mode	
		b'1	General serial audio, slave mode	

Addr 0x01 : General Serial Audio Format

Bit	7	6	5	4	3	2	1	0
Name	X	X	BCKS		BS		MLF	LRJ

Name	Description	Value	Meaning	Ref.
LRJ	Serial data justify	b'0	Left justify	
		b'1	Right justify	
MLF	Serial bit order	b'0	MSB first	
		b'1	LSB first	
BS	Serial bit size	b'00	24 bit	
		b'01	20 bit	
		b'10	18 bit	
		b'11	16 bit	
BCKS	Bit clock size select	b'00	64 BCK/WCK	
		b'01	48 BCK/WCK	
		b'10	32 BCK/WCK	

Addr 0x02 : Master Clock Frequency Control

Bit	7	6	5	4	3	2	1	0
Name	X	X	X	X	X	MCF		

Name	Description	Value	Meaning	Ref.
MCF	Master Clock Frequency	b'000	3.072 MHz (WCK 48 kHz) / 2.8224 MHz (WCK 44.1 kHz)	
		b'001	6.144 MHz (WCK 96 kHz)	
		b'010	2.048 MHz (WCK 32 kHz)	

Addr 0x03~0x06 : Mixer Gain

Bit	7	6	5	4	3	2	1	0
Name	X	MG						

Name	Description	Value	Meaning	Ref.
MG	Mixer gain	h'00 ~ h'7E	Mixer gain (refer to gain table)	

$$\begin{bmatrix} mixer_ch1_output \\ mixer_ch2_output \end{bmatrix} = \begin{bmatrix} 0x03 & 0x04 \\ 0x05 & 0x06 \end{bmatrix} \cdot \begin{bmatrix} I2S_ch1_input \\ I2S_ch2_input \end{bmatrix}$$

Mixer equation

$$\begin{bmatrix} mixer_ch1_output \\ mixer_ch2_output \end{bmatrix} = \begin{bmatrix} 0dB(0x4E) & -\infty dB(0x00) \\ -\infty dB(0x00) & 0dB(0x4E) \end{bmatrix} \cdot \begin{bmatrix} I2S_ch1_input \\ I2S_ch2_input \end{bmatrix}$$

Reset default

Addr 0x07 : RS DRC Control 8

Bit	7	6	5	4	3	2	1	0
Name	Post_S	High_S	Low_S	Sub_S	X	X	X	Rel_En

Name	Description	Value	Meaning	Ref.
Rel_En	RS DRC Release Filter Enable	b'0	Bypass	
		b'1	Release Filter Enable (Attack Filter Bypass)	
Sub_S	DRC Ver. Selection for Sub-Band	b'0	Old Version (Peak Detection)	
		b'1	New Version (Vrms Detection)	
Low_S	DRC Ver. Selection for Low-Band	b'0	Old Version (Peak Detection)	
		b'1	New Version (Vrms Detection)	
High_S	DRC Ver. Selection for High-Band	b'0	Old Version (Peak Detection)	
		b'1	New Version (Vrms Detection)	
Post_S	DRC Ver. Selection for Post-Band	b'0	Old Version (Peak Detection)	
		b'1	New Version (Vrms Detection)	

Addr 0x08 : TV Volume

Bit	7	6	5	4	3	2	1	0
Name	X	TV_VOL						

Name	Description	Value	Meaning	Ref.
TV_VOL	Volume of TV-Set	b'00000000 ~ b'1100100	0 ~ 100	

Reserved Address 0x09 ~ 0x0A

Addr 0x0B : Soft Reset Control

Bit	7	6	5	4	3	2	1	0
Name	X	X	X	X	X	X	X	Rst

Name	Description	Value	Meaning	Ref.
Rst	Soft Reset	b'0	Normal operation mode	
		b'1	Reset all functions and return to '0' automatically thereafter	

Addr 0x0C : Master Volume & SPK PWM Switching On/Off Control

Bit	7	6	5	4	3	2	1	0
Name	MVOL						SPOF	

Name	Description	Value	Meaning	Ref.
SPOF	Smart Switching Output on/off Control	b'00000000	PWM off (softmute on →pwm off →pwm_mask low)	
		b'00000001	PWM off (softmute on →pwm off→pwm_mask high)	
		b'00000010	PWM on (softmute on →pwm_mask high →pwm on)	
		b'00000011	PWM on (pwm_mask high →pwm on →softmute off)	
MVOL	Volume control	b'00000100 ~ b'11111111	refer to master volume table. Reset default is 0x00 (= -∞ dB). 0xFF means 0dB with 0.5dB step	

Reserved Address 0x0D

Addr 0x0E~0x0F : PEQ Filter Control 0 for Ch1 and Ch2 respectively

Bit	7	6	5	4	3	2	1	0
Name	X	X	BQ3		BQ2		BQ1	

Name	Description	Value	Meaning	Ref.
BQ1	On/off Bi-Quad 1 of ch. n (n= 1,2)	b'00	Bypass Bi-Quad 1 of channel n	
		b'01	Enable Bi-Quad 1 of channel n	
		b'10	Enable Bi-Quad 1 as Loudness Filter	
BQ2	On/off Bi-Quad 2 of ch. n (n= 1,2)	b'00	Bypass Bi-Quad 2 of channel n	
		b'01	Enable Bi-Quad 2 of channel n	
		b'10	Enable Bi-Quad 2 as Loudness Filter	
BQ3	On/off Bi-Quad 3 of ch. n (n= 1,2)	b'00	Bypass Bi-Quad 3 of channel n	
		b'01	Enable Bi-Quad 3 of channel n	
		b'10	Enable Bi-Quad 3 as Loudness Filter	

Addr 0x10~0x11 : PEQ Filter Control 1 for Ch1, Ch2 respectively

Bit	7	6	5	4	3	2	1	0
Name	X	X	X	X	X	BQ6	BQ5	BQ4

Name	Description	Value	Meaning	Ref.
BQ4	On/off Bi-Quad 4 of ch. n (n= 1,2)	b'0	Bypass Bi-Quad 4 of channel n	
		b'1	Enable Bi-Quad 4 of channel n	
BQ5	On/off Bi-Quad 5 of ch. n (n= 1,2)	b'0	Bypass Bi-Quad 5 of channel n	
		b'1	Enable Bi-Quad 5 of channel n	
BQ6	On/off Bi-Quad 6 of ch. n (n= 1,2)	b'0	Bypass Bi-Quad 6 of channel n	
		b'1	Enable Bi-Quad 6 of channel n	

Addr 0x12~0x13 : APEQ Filter Control 0 for Ch1 and Ch2 respectively

Bit	7	6	5	4	3	2	1	0
Name	BQ10		BQ9		BQ8		BQ7	

Name	Description	Value	Meaning	Ref.
BQ7	On/off Bi-Quad 7 of ch. n (n = 1,2)	b'00	Bypass Bi-Quad 7 of channel n	
		b'01	Enable Bi-Quad 7 of channel n	
		b'10	Enable Bi-Quad 7 of channel n as APEQ	
		b'11	Reserved	
BQ8	On/off Bi-Quad 8 of ch. n (n = 1,2)	b'00	Bypass Bi-Quad 8 of channel n	
		b'01	Enable Bi-Quad 8 of channel n	
		b'10	Enable Bi-Quad 8 of channel n as APEQ	
		b'11	Reserved	
BQ9	On/off Bi-Quad 9 of ch. n (n = 1,2)	b'00	Bypass Bi-Quad 9 of channel n	
		b'01	Enable Bi-Quad 9 of channel n	
		b'10	Enable Bi-Quad 9 of channel n as APEQ	
		b'11	Reserved	
BQ10	On/off Bi-Quad 10 of ch. n (n = 1,2)	b'00	Bypass Bi-Quad 10 of channel n	
		b'01	Enable Bi-Quad 10 of channel n	
		b'10	Enable Bi-Quad 10 of channel n as APEQ	
		b'11	Reserved	

Addr 0x14~0x15 : APEQ Filter Control 1 for Ch1 and Ch2 respectively

Bit	7	6	5	4	3	2	1	0
Name	BQ16	BQ15	BQ14	BQ13	BQ12		BQ11	

Name	Description	Value	Meaning	Ref.
BQ11	On/off Bi-Quad 11 of ch. n (n = 1,2)	b'00	Bypass Bi-Quad 11 of channel n	
		b'01	Enable Bi-Quad 11 of channel n	
		b'10	Enable Bi-Quad 11 of channel n as APEQ	
		b'11	Reserved	
BQ12	On/off Bi-Quad 12 of ch. n (n = 1,2)	b'00	Bypass Bi-Quad 12 of channel n	
		b'01	Enable Bi-Quad 12 of channel n	
		b'10	Enable Bi-Quad 12 of channel n as APEQ	
		b'11	Reserved	
BQ13	On/off Bi-Quad 13 of ch. n (n = 1,2)	b'0	Bypass Bi-Quad 13 of channel n	
		b'1	Enable Bi-Quad 13 of channel n	
BQ14	On/off Bi-Quad 14 of ch. n (n = 1,2)	b'0	Bypass Bi-Quad 14 of channel n	
		b'1	Enable Bi-Quad 14 of channel n	
BQ15	On/off Bi-Quad 15 of ch. n (n = 1,2)	b'0	Bypass Bi-Quad 15 of channel n	
		b'1	Enable Bi-Quad 15 of channel n	
BQ16	On/off Bi-Quad 16 of ch. n (n = 1,2)	b'0	Bypass Bi-Quad 16 of channel n	
		b'1	Enable Bi-Quad 16 of channel n	

Addr 0x16 : Master Volume Fine Control

Bit	7	6	5	4	3	2	1	0
Name	X	X	X	X	X	X		MVFC

Name	Description	Value	Meaning	Ref.
MVFC	Master volume fine control	b'00 ~ b'11	0 dB ~ 0.375 dB with 0.125 dB step	

Addr 0x17~0x18 : Ch1/2 Volume, respectively

Bit	7	6	5	4	3	2	1	0
Name	VOL							

Name	Description	Value	Meaning	Ref.
VOL	Volume control	b'00000000 ~ b'11111111	refer to channel volume table. Reset default is 0x9F (= 0dB). 0xFF means 48dB with 0.5dB step.	

Addr 0x19 : APEQ Path Option

Bit	7	6	5	4	3	2	1	0
Name	X	X	X	X	X			OPT

Name	Description	Value	Meaning	Ref.
Opt	APEQ Path Option	b'000	cut1=>Vol=>PEQ6=>APEQ6=>DRC=>cut2	Set b'000 for APEQ op. (Same effect btw b'000 & b'010)
		b'001	Reserved	
		b'010	cut1=>PEQ6=>Vol=>APEQ6=>DRC=>cut2	
		b'011	Reserved	
		b'100	cut1=>PEQ6=>APEQ6=>Vol=>DRC=>cut2	
		b'101	Reserved	

Addr 0x1A : APEQ Filter Control 2 for APEQ1 (BQ7)

Bit	7	6	5	4	3	2	1	0
Name	X	C1C_DP1			A1C_DP1			
Name	Description	Value	Meaning		Ref.			
A1C_DP1	APEQ attack time	b'0000 b'1010	~ Attack time control (refer to APEQ attack time table below)					
C1C_DP1	APEQ release time	b'000 b'111	~ Release time control (refer to APEQ release time table below)					

Value of Register	Attack time 6dB, fs = 96,000
0011	15msec
0010	8msec
0001	4msec
0000	2msec
0111	1msec
0110	0.5msec
0101	0.25msec
0100	0.125msec
1000	2.5msec
1001	3msec
1010	3.5msec

Table 11. APEQ Attack Time Table

Value of Register	Release time 6dB, fs = 96,000
011	5.0sec
010	2.0sec
001	1.0sec
000	0.5sec
111	0.2sec
110	0.1sec
101	0.05sec
100	0.025sec

Table 12. APEQ Release Time Table

Addr 0x1B : APEQ Filter Control 3 for APEQ2 (BQ8)

Bit	7	6	5	4	3	2	1	0
Name	X	C1C_DP2			A1C_DP2			
Name	Description	Value	Meaning		Ref.			
A1C_DP2	APEQ attack time	b'0000 b'1010	~ Attack time control (refer to APEQ attack time table in Addr 0x1A)					
C1C_DP2	APEQ release time	b'000 b'111	~ Release time control (refer to APEQ release time table in Addr 0x1A)					

Addr 0x1C : APEQ Filter Control 4 for APEQ3 (BQ9)

Bit	7	6	5	4	3	2	1	0
Name	X	C1C_DP3			A1C_DP3			
Name	Description	Value	Meaning		Ref.			
A1C_DP3	APEQ attack time	b'0000 b'1010	~ Attack time control (refer to APEQ attack time table in Addr 0x1A)					
C1C_DP3	APEQ release time	b'000 b'111	~ Release time control (refer to APEQ release time table in Addr 0x1A)					

Addr 0x1D : APEQ Filter Control 5 for APEQ4 (BQ10)

Bit	7	6	5	4	3	2	1	0
Name	X	C1C_DP4			A1C_DP4			

Name	Description	Value	Meaning	Ref.
A1C_DP4	APEQ attack time	b'0000 b'1010	~ Attack time control (refer to APEQ attack time table in Addr 0x1A)	
C1C_DP4	APEQ release time	b'000 b'111	~ Release time control (refer to APEQ release time table in Addr 0x1A)	

Addr 0x1E : APEQ Filter Control 6 for APEQ5 (BQ11)

Bit	7	6	5	4	3	2	1	0
Name	X	C1C_DP5			A1C_DP5			

Name	Description	Value	Meaning	Ref.
A1C_DP5	APEQ attack time	b'0000 b'1010	~ Attack time control (refer to APEQ attack time table in Addr 0x1A)	
C1C_DP5	APEQ release time	b'000 b'111	~ Release time control (refer to APEQ release time table in Addr 0x1A)	

Addr 0x1F : APEQ Filter Control 7 for APEQ6 (BQ12)

Bit	7	6	5	4	3	2	1	0
Name	X	C1C_DP6			A1C_DP6			

Name	Description	Value	Meaning	Ref.
A1C_DP6	APEQ attack time	b'0000 b'1010	~ Attack time control (refer to APEQ attack time table in Addr 0x1A)	
C1C_DP6	APEQ release time	b'000 b'111	~ Release time control (refer to APEQ release time table in Addr 0x1A)	

Addr 0x20 : DRC Control 0

Bit	7	6	5	4	3	2	1	0
Name	CPR_L	CTS_L						

Name	Description	Value	Meaning	Ref.
CTS_L	DRC threshold for Low band	b'0000000 ~ b'1111111	-57 ~ 12dB unsigned 7-bit DRC threshold for 1 band mode. In 2 band mode, It will control the threshold of low band. Refer to DRC threshold table for threshold values.	
CPR_L	DRC enable for Low band	b'0	Dynamic Range Compression off	
		b'1	Dynamic Range Compression on	

Addr 0x21 : DRC Control 1

Bit	7	6	5	4	3	2	1	0
Name	X	C1C_L			A1C_L			

Name	Description	Value	Meaning	Ref.
A1C_L	DRC attack time (Low band)	b'0000 ~ b'1010	Attack time control for 1 band mode. In 2 band mode, it will control the attack time of low band. (refer to DRC attack time table below) default = b'0001	
C1C_L	DRC release time (Low band)	b'000 ~ b'111	Release time control for 1 band mode. In 2 band mode, it will control the release time of low band. (refer to DRC release time table below)	

Value of Register	Attack time 6dB, fs = 96,000
0011	30msec
0010	15msec
0001	8msec
0000	4msec
0111	2msec
0110	1msec
0101	0.5msec
0100	0.25msec
1000	5msec
1001	6msec
1010	7msec

Table 13. DRC Attack Time Table

Value of Register	Release time 6dB, fs = 96,000
011	5.0sec
010	2.0sec
001	1.0sec
000	0.5sec
111	0.2sec
110	0.1sec
101	0.05sec
100	0.025sec

Table 14. DRC Release Time Table

Addr 0x22 : DRC Control 2

Bit	7	6	5	4	3	2	1	0
Name	CPR_H	CTS_H						

Name	Description	Value	Meaning	Ref.
CTS_H	DRC threshold for High band	b'0000000 ~ b'1111111	-57 ~ 12dB unsigned 7-bit DRC threshold for high band. It has effect only in 2 band mode. Refer to DRC threshold value table for threshold values.	
CPR_H	DRC enable for High band	b'0	Dynamic Range Compression off	
		b'1	Dynamic Range Compression on	

Addr 0x23 : DRC Control 3

Bit	7	6	5	4	3	2	1	0
Name	X	C1C_H			A1C_H			

Name	Description	Value	Meaning	Ref.
A1C_H	DRC attack time (High band)	b'0000 ~ b'1010	Attack time control for high band mode. It has effect only in 2 band mode. (See DRC attack time table in Addr 0x21) default = b'0001	
C1C_H	DRC release time (High band)	b'000 ~ b'111	Release time control for high band mode. It has effect only in 2 band mode. (refer to DRC release time table in Addr 0x21)	

Addr 0x24 : RS DRC Control 0

Bit	7	6	5	4	3	2	1	0
Name	RS_EN	X	X	X	X	X	X	X

Name	Description	Value	Meaning	Ref.
RS_EN	RS DRC Enable	b'0	Disable RS DRC	
		b'1	Enable RS DRC	

Addr 0x25 : RS DRC Control 1

Bit	7	6	5	4	3	2	1	0
Name	Period_L(7:0)							

Name	Description	Value	Meaning	Ref.
Period_L	Vrms Period for Low-Band	h'0A	Period of Vrms calculation for High-Band. Roughly, the step between 1 and 10 is 0.1ms, and between 11 and 127 is 0.7ms. Over 128 is meaningless. Ex) 0x28 represents about 22ms. (22ms = 0.1ms*10 + 0.7ms*30)	

Addr 0x26 : DRC Control 6

Bit	7	6	5	4	3	2	1	0
Name	CPR_P	CTS_P						

Name	Description	Value	Meaning	Ref.
CTS_P	DRC threshold for Post band	b'0000000 ~ b'1111111	-57 ~ 12dB unsigned 7-bit DRC threshold Refer to DRC threshold table.	
CPR_P	DRC enable for Post band	b'0	Dynamic Range Compression off	
		b'1	Dynamic Range Compression on	

Addr 0x27 : DRC Control 7

Bit	7	6	5	4	3	2	1	0
Name	X	C1C_P			A1C_P			

Name	Description	Value	Meaning	Ref.
A1C_P	DRC attack time (Post band)	b'0000 ~ b'1010	Attack time control (refer to DRC attack time table in Addr 0x21) default = b'0001	
C1C_P	DRC release time (Post band)	b'000 ~ b'111	Release time control (refer to DRC release time table in Addr 0x21) default = b'100	

Addr 0x28 : DRC Control 8

Bit	7	6	5	4	3	2	1	0
Name	X	X	X	DLL				

Name	Description	Value	Meaning	Ref.
DLL	Delay line length	b'00000~ b'10100	Delay line length. 0~20(decimal)	

Addr 0x29 : DRC Control 9

Bit	7	6	5	4	3	2	1	0
Name	CCO	DTS1	DTS2	2BM	X	X	X	CAS

Name	Description	Value	Meaning	Ref.
CAS	Coupled All pass Structure enable	b'0	Enable coupled all pass structure	
		b'1	Disable coupled all pass structure	
2BM	2band mode enable	b'0	1 band DRC	
		b'1	2 band DRC	
DTS2	P-DRC type select	b'0	P-DRC new mode	
		b'1	P-DRC old mode	
DTS1	LH-DRC type select	b'0	LH-DRC new mode	
		b'1	LH-DRC old mode	
CCO	Clip control option	b'0	Clip off	
		b'1	Clip on	

Addr 0x2A : DRC Control 10

Bit	7	6	5	4	3	2	1	0
Name	CPR_S	CTS_S						

Name	Description	Value	Meaning	Ref.
CTS_S	DRC threshold for Sub band	b'0000000 ~ b'1111111	-57 ~ 12dB unsigned 7-bit DRC threshold for Sub band. It has effect only in 3 band mode. Refer to DRC threshold table for threshold values. default= b'1101010	
CPR_S	DRC enable for Sub band	b'0	Dynamic Range Compression off	
		b'1	Dynamic Range Compression on	

Addr 0x2B : DRC Control 11

Bit	7	6	5	4	3	2	1	0
Name	X	C1C_S	A1C_S					

Name	Description	Value	Meaning	Ref.
A1C_S	DRC attack time (Sub band)	b'0000 ~ b'1010	Attack time control for sub band mode. It has effect only in 3 band mode. (Refer to DRC attack time table in Addr 0x21.) default = b'0001	
C1C_S	DRC release time (Sub band)	b'000 ~ b'111	Release time control for sub band mode. It has effect only in 3 band mode. (refer to DRC release time table in Addr 0x21.)	

Addr 0x2C : DRC Control 12

Bit	7	6	5	4	3	2	1	0
Name	X	X	X	X	X	X	DTS3	SBM

Name	Description	Value	Meaning	Ref.
SBM	Sub band mode enable	b'0	Sub band mode Disable	
		b'1	Sub band mode Enable	
DTS3	Sub DRC type select	b'0	Sub DRC new mode	
		b'1	Sub DRC old mode	

Addr 0x2D : Threshold Table Mapping Coefficient for RS DRC

Bit	7	6	5	4	3	2	1	0
Name	X	X	X	COEF_SEL				

Name	Description	Value	Meaning	Ref.
COEF_SEL	Threshold Table Mapping	d'10	Default Value : 10 (= 2.0) The range is between 0 and 20, and the step unit is 0.1. For example, 0x0F means 2.5.	

Addr 0x2E : Power Meter Control

Bit	7	6	5	4	3	2	1	0
Name	X	X	X	PDPOS	X	X	PDCH	

Name	Description	Value	Meaning	Ref.
PDCH	Power meter Detect Channel	b'00	L+R (default)	
		b'01	L channel	
		b'10	R channel	
PDPOS	Power meter Detect Position	b'0	After volume (default)	
		b'1	Before volume (from digital input)	

Addr 0x2F : Power Meter(read only)

Bit	7	6	5	4	3	2	1	0
Name	Power meter							

Addr 0x30 : Soft Volume Control

Bit	7	6	5	4	3	2	1	0
Name	X	X	X	X	X	X	SVI	

Name	Description	Value	Meaning	Ref.
SVI	Soft volume change	b'00	Medium speed	
		b'01	High speed	
		b'10	Low speed	
		b'11	soft volume change disable	

Addr 0x31 : IBB Parameter Selection

Bit	7	6	5	4	3	2	1	0
Name	X	X	X	X	P_SEL			

Name	Description	Value	Meaning	Ref.	
P_SEL	Volume Parameter	0x00	Volume0	Before writing values at the register of 0x32, the relevant parameters in P_SEL should be written.	
		0x01	Volume1		
		0x02	Volume2		
		0x03	Volume3		
		0x04	Volume4		
	Gain Parameters	0x05	Gain0 (dB)		
		0x06	Gain1 (dB)		
		0x07	Gain2 (dB)		
		0x08	Gain3 (dB)		
		0x09	Gain4 (dB)		
	Slope Parameters	0x0A	Slope0 = (Gain1 – Gain0)/(Vol1 – Vol0)		
		0x0B	Slope1 = (Gain2 – Gain1)/(Vol2 – Vol1)		
		0x0C	Slope2 = (Gain3 – Gain2)/(Vol3 – Vol2)		
0x0D		Slope3 = (Gain4 – Gain3)/(Vol4 – Vol3)			

Addr 0x32 : IBB Parameter Value

Bit	7	6	5	4	3	2	1	0
Name	P_VAL							

Name	Description	Value	Meaning	Ref.
P_VAL	Volume	0 ~ 100	Set volume of each inflection point. The relevant point should be selected in the 0x31 register as one of 0x0 ~ 0x4.	Up to four inflection points can be set, and its relevant selection, P_SEL, in the 0x31 register should be properly written before writing P_VAL
	Gain (dB)	0 ~ 90	Set gain of each inflection point. The relevant point should be selected in the 0x31 register as one of 0x5 ~ 0x9.	
	Slope (dB)	0x00 ~ 0xFF	Set slope value between adjacent inflection points. The relevant interval should be selected in the 0x31 register as one of 0xA ~ 0xD. (Data format is sx.xxxxxx. e.g. for the slope value of -1, the relevant register value is 11000000b)	

Volume	Gain (dB)	Slope
10	15	0xDA
20	9	0xFA
50	6	0xF6
80	1	0xFD
100	0	-

Table 15. Default IBB Parameter Table

Addr 0x33 : Soft Mute Control

Bit	7	6	5	4	3	2	1	0
Name	SMH	X	X	X	X	X	SM2	SM1

Name	Description	Value	Meaning	Ref.
SMn	Soft mute	b'0	increase for channel n	
		b'1	decrease for channel n	
SMH	Soft Mute Change speed	b'0	42/46 msec (at 96/88.2kHz)	
		b'1	Hard change	

Addr 0x34 : PWM Switching On/Off Control

Bit	7	6	5	4	3	2	1	0
Name	X	X	X	X	X	X	POF2	POF1

Name	Description	Value	Meaning	Ref.
POFn	Switching output On/off control	b'0	Channel n PWM switching on	
		b'1	Channel n PWM switching off	

Addr 0x35 : PWM_MASK Control 0

Bit	7	6	5	4	3	2	1	0
Name	X	X	X	X	SRD	FPMLD	PWMM	

Name	Description	Value	Meaning	Ref.
PWMM	PWM MASK register	b'10	PWM MASK output is low.	
		Otherwise	PWM MASK output is high.	
FPMLD	Permanent PWM_MASK Low disable flag	b'0	No effect	
		b'1	Reset the Auto PWM_MASK restore counter to 0	
SRD	FAULT disable	b'0	FAULT is effective for PROTECT	
		b'1	FAULT is ineffective for PROTECT	

Addr 0x36 : PWM_MASK Control 1

Bit	7	6	5	4	3	2	1	0
Name	X	X	X	X	X	X	APM	POF

Name	Description	Value	Meaning	Ref.
POF	PWM off flag	b'0	Even if Auto PWM_MASK condition is met, the PWM output of all channels is not affected.	
		b'1	When Auto PWM_MASK condition is met, the PWM output of all channels goes to the defined state which is set by the PWM off state control registers (Addr 0x37 & 0x6F).	
APM	PWM_MASK flag	b'0	Even if Auto PWM_MASK condition is met, the PWM_MASK output of all channels is not affected.	
		b'1	When Auto PWM_MASK condition is met, the PWM_MASK output goes to Low state.	

Addr 0x37 : PWM_MASK Control 2

Bit	7	6	5	4	3	2	1	0
Name	X	VMSK2	VMSK1	VMSK0	X	PMSK2	PMSK1	PMSK0

Name	Description	Value	Meaning	Ref.
PMSKn	Masking bit of PWM off control	b'0	Mask bit indicating the validity of n-th bit of Addr 0x75 system register: If the n-th bit of this register is zero, the n-th bit of Addr 0x75 system register is invalid. The n-th bit of Addr 0x75 is valid only when the n-th mask bit is one.	
		b'1		
VMSKn	Masking bit of PWM_MASK signal	b'0		
		b'1		

Addr 0x38 : PWM_MASK Control 3

Bit	7	6	5	4	3	2	1	0
Name	IRC		AVRCT			PHT		

Name	Description	Value	Meaning	Ref.
PHT	PWM_MASK Low Hold Time	b'000	0.5 msec Hold Time	
		b'001	1 msec Hold Time	
		b'010	2 msec Hold Time	
		b'011	4 msec Hold Time (Default)	
		b'100	8 msec Hold Time	
		b'101	16msec Hold Time	
AVRCT	Auto PWM_MASK Restore Counter Threshold	b'000	2	
		b'001	5 (Default)	
		b'010	10	
		b'011	15	
		b'100	20	
		b'101	25	
IRC	Auto PWM_MASK Restore Interval Ratio Control	b'00	2 (Default)	
		b'01	4	

Addr 0x39 : PWM_MASK Control 4

Bit	7	6	5	4	3	2	1	0
Name	SHE	POE	X	X	X	HT2		

Name	Description	Value	Meaning	Ref.
HT2	Hold Time 2 apply start point (restore counter)	b'000	100 msec Hold Time	
		b'001	200 msec Hold Time	
		b'010	400 msec Hold Time	
		b'011	600 msec Hold Time (Default)	
		b'100	800 msec Hold Time	
		b'101	1 sec Hold Time	
		b'110	2 sec Hold Time	
		b'111	4 sec Hold Time	
POE	PWM off when PWM_MASK off and PWM on when PWM_MASK recovers	b'0	Disable	
		b'1	Enable (Default)	
SHE	Second Hold time Enable	b'0	Disable	
		b'1	Enable	

Addr 0x3A : Auto-Mute Control for CH1 & CH2

Bit	7	6	5	4	3	2	1	0
Name	X	EAMC	II		AT			

Name	Description	Value	Meaning	Ref.
AT	Auto-mute detection threshold	b'0000 ~ b'1111	Unsigned integer between 0 and 15 Refer to Auto Mute detection threshold table for threshold values.	
II	Auto-mute response time	b'00	5 msec	
		b'01	50 msec	
		b'10	500 msec	
		b'11	2 sec	
EAMC	Effect of Auto-mute condition	b'0	Auto mute disable (No-Effect)	
		b'1	Stop PWM switching when auto-mute condition is met.	

Reserved Address 0x3B

Addr 0x3C : CH1&CH2 Prescaler Value Control

Bit	7	6	5	4	3	2	1	0
Name	PS12							

Name	Description	Value	Meaning	Ref.
PS12	Prescaler value	b'00000000 ~ b'11111111	default = 0x4C	

Addr 0x3D : WCK Synchronization Control

Bit	7	6	5	4	3	2	1	0
Name	SYN_En	X	X	X	X	X	X	X

Name	Description	Value	Meaning	Ref.
SYN_En	WCK synchronization	b'0	Disable	
		b'1	Enable	

Addr 0x3E : PWM Output Port Control for PWM Port 1A & 1B

Bit	7	6	5	4	3	2	1	0
Name	X	X	OPM1B			OPM1A		

Name	Description	Value	Meaning	Ref.
OPM1A	Select source channel for PWM output port 1A	b'000	PWM1A is connected to PWM port 1A	
		b'001	PWM1B is connected to PWM port 1A	
		b'010	PWM2A is connected to PWM port 1A	
		b'011	PWM2B is connected to PWM port 1A	
OPM1B	Select source channel for PWM output port 1B	b'000	PWM1A is connected to PWM port 1B	
		b'001	PWM1B is connected to PWM port 1B	
		b'010	PWM2A is connected to PWM port 1B	
		b'011	PWM2B is connected to PWM port 1B	

Addr 0x3F : PWM Output Port Control for PWM Port 2A & 2B

Bit	7	6	5	4	3	2	1	0
Name	X	X	OPM2B			OPM2A		

Name	Description	Value	Meaning	Ref.
OPM2A	Select source channel for PWM output port 2A	b'000	PWM1A is connected to PWM port 2A	
		b'001	PWM1B is connected to PWM port 2A	
		b'010	PWM2A is connected to PWM port 2A	
		b'011	PWM2B is connected to PWM port 2A	
OPM2B	Select source channel for PWM output port 2B	b'000	PWM1A is connected to PWM port 2B	
		b'001	PWM1B is connected to PWM port 2B	
		b'010	PWM2A is connected to PWM port 2B	
		b'011	PWM2B is connected to PWM port 2B	

Addr 0x40 : NS Soft Mute Control

Bit	7	6	5	4	3	2	1	0
Name	X	X	Time_Lim	Enable	CNT_THR			
Name	Description	Value	Meaning		Ref.			
CNT_THR	Minimum counting value	b'0000~ b'1111	Minimum counting value of continuous zeros for forcing NS_OUT as 0. default = b'0110					
Enable	Enable NS soft mute	b'0	Disable					
		b'1	Enable					
Time_Lim	Time limit on finding continuous zeros	b'0	Time Limit = 200ms					
		b'1	Time Limit = 400ms					

Addr 0x41 : Modulation Index & NS-Type Control

Bit	7	6	5	4	3	2	1	0
Name	X	M0		FB	X	NTF_Order	MD12	
Name	Description	Value	Meaning		Ref.			
MD12	Modulation index control by Minimum pulse width for Ch 1&2	b'00	Minimum pulse width = 80 ns					
		b'01	Minimum pulse width = 60 ns					
		b'10	Minimum pulse width = 40 ns					
		b'11	Minimum pulse width = 20 ns					
NTF_Order	Select NTF Order	b'0	NTF Order = 4					
		b'1	NTF Order = 5					
FB	Feed Back on/off	b'0	NS Feed Back off					
		b'1	NS Feed Back on					
M0	Dither Position Selector	b'00	No left shift on dither value = Dither off					
		b'01	1bit left shift on dither value					
		b'10	2bit left shift on dither value					
		b'11	3bit left shift on dither value					

Addr 0x42 : NS Feedback Limit

Bit	7	6	5	4	3	2	1	0
Name	X	FBMAX						
Name	Description	Value	Meaning		Ref.			
FBMAX	Feedback on/off	b'0000000 ~b'1111111	Feedback limit, default = 0x04					

Addr 0x43 : Miscellaneous PWM Control

Bit	7	6	5	4	3	2	1	0
Name	X	X	X	X	BHL	AHL	MD	
Name	Description	Value	Meaning		Ref.			
MD	PWM output mode	b'00	AD mode with asynchronous signal pair					
		b'01	AD mode with synchronous signal pair					
		b'10	PWM D-BTL MODE (see 0x45)					
AHL	A-out state When switching off	b'0	Low					
		b'1	High					
BHL	B-out state when switching off	b'0	Low					
		b'1	High					

Addr 0x44 : PWM D-BTL MODE Control 0

Bit	7	6	5	4	3	2	1	0
Name	X	MLP						

Name	Description	Value	Meaning	Ref.
MLP	Minimum Linear pulse length	b'0001110	Unsigned 0~64	

Addr 0x45 : PWM D-BTL MODE Control 1

Bit	7	6	5	4	3	2	1	0
Name	X	X	X	X	X	X	NSS	

Name	Description	Value	Meaning	Ref.
NSS	NS Select	b'00	7bits NS (AD mode)	
		b'01	Reserved	
		b'10	8bits NS	
		b'11	New 8bits NS (D-BTL mode)	

Reserved Address 0x46 ~ 0x49

Addr 0x4A : Soft Start Control 0

Bit	7	6	5	4	3	2	1	0
Name	PSE	SRT						

Name	Description	Value	Meaning	Ref.
SRT	Step Repeat Time	b'000000 ~b'111111	Repeat time of each step (default = b'0010000 – means repeat 17 times)	
PSE	PWM soft start Enable	b'0	Disable	
		b'1	Enable (only under AD mode)	

Addr 0x4B : Soft Start Control 1

Bit	7	6	5	4	3	2	1	0
Name	X	X	X	X	X	X	MP_PD	

Name	Description	Value	Meaning	Ref.
MP_PD	Soft start minimum pulse of Power device	b'00	First pulse width = 20 ns	
		b'01	First pulse width = 40 ns	
		b'10	First pulse width = 60 ns	
		b'11	First pulse width = 80 ns	

Reserved Address 0x4C

Addr 0x4D : RS DRC Control 5

Bit	7	6	5	4	3	2	1	0
Name	Period_H (7:0)							

Name	Description	Value	Meaning	Ref.
Period_H	Vrms Period for High-Band	h'0A	Period of Vrms calculation for High-Band. Roughly, the step between 1 and 10 is 0.1ms, and between 11 and 127 is 0.7ms. Over 128 is meaningless. Ex) 0x28 represents about 22ms. (22ms = 0.1ms*10 + 0.7ms*30)	

Addr 0x4E : RS DRC Control 6

Bit	7	6	5	4	3	2	1	0
Name	Period_S (7:0)							

Name	Description	Value	Meaning	Ref.
Period_S	Vrms Period for Sub-Band	h'0A	Period of Vrms calculation for High-Band. Roughly, the step between 1 and 10 is 0.1ms, and between 11 and 127 is 0.7ms. Over 128 is meaningless. Ex) 0x28 represents about 22ms. (22ms = 0.1ms*10 + 0.7ms*30)	

Addr 0x4F : RS DRC Control 7

Bit	7	6	5	4	3	2	1	0
Name	Period_P (7:0)							

Name	Description	Value	Meaning	Ref.
Period_P	Vrms Period for Post-Band	h'0A	Period of Vrms calculation for High-Band. Roughly, the step between 1 and 10 is 0.1ms, and between 11 and 127 is 0.7ms. Over 128 is meaningless. Ex) 0x28 represents about 22ms. (22ms = 0.1ms*10 + 0.7ms*30)	

Addr 0x50 : AD DC Protection Control 0

Bit	7	6	5	4	3	2	1	0
Name	PDH				PDL			

Name	Description	Value	Meaning	Ref.
PDL	PWM Duty Low for Modulation Index Error	b'0000	40%	
		b'0001	35%	
		b'0010	30%	
		b'0011	25%	
		b'0100	20%	
		b'0101	15%	
		b'0110	10%	
		b'0111	5%	
		b'1000	45%	
PDH	PWM Duty High for Modulation Index Error	b'0000	60%	
		b'0001	65%	
		b'0010	70%	
		b'0011	75%	
		b'0100	80%	
		b'0101	85%	
		b'0110	90%	
		b'0111	95%	
		b'1000	55%	

Addr 0x51 : D-BTL DC Protection Control 1

Bit	7	6	5	4	3	2	1	0
Name	X	X	X	X	MLPA			

Name	Description	Value	Meaning	Ref.
MLPA	D-BTL Duty High for Modulation Index Error	b'0000	5%	
		b'0001	10%	
		b'0010	15%	
		b'0011	20%	
		b'0100	25%	
		b'0101	30%	
		b'0110	35%	
		b'0111	40%	
		b'1000	45%	
b'1001	50%			

Addr 0x52 : DC Protection Control 2

Bit	7	6	5	4	3	2	1	0
Name	X	X	X	X	X	PFE	DFE	MFE

Name	Description	Value	Meaning	Ref.
MFE	Modulation Index Error Enable	b'0	Modulation Index Error Disable	
		b'1	Modulation Index Error Enable	
DFE	DRC Coefficient Error Enable	b'0	MDRC Coefficient Error Disable	
		b'1	MDRC Coefficient Error Enable	
PFE	PEQ Coefficient Error Enable	b'0	PEQ Coefficient Error Disable	
		b'1	PEQ Coefficient Error Enable	

Addr 0x53 : DC Protection Control 3

Bit	7	6	5	4	3	2	1	0
Name	X	X	PCS3					

Name	Description	Value	Meaning	Ref.
PCS3	PEQ RX Checksum(29:24)		default = 0x36	

Addr 0x54 : DC Protection Control 4

Bit	7	6	5	4	3	2	1	0
Name	PCS2							

Name	Description	Value	Meaning	Ref.
PCS2	PEQ RX Checksum (23:16)		default = 0x00	

Addr 0x55 : DC Protection Control 5

Bit	7	6	5	4	3	2	1	0
Name	PCS1							

Name	Description	Value	Meaning	Ref.
PCS1	PEQ RX Checksum (15:8)		default = 0x00	

Addr 0x56 : DC Protection Control 6

Bit	7	6	5	4	3	2	1	0
Name	PCS0							

Name	Description	Value	Meaning	Ref.
PCS0	PEQ RX Checksum (7:0)		default = 0x00	

Addr 0x57 : DC Protection Control 7

Bit	7	6	5	4	3	2	1	0
Name	X	X	DCS3					

Name	Description	Value	Meaning	Ref.
DCS3	MDRC RX Checksum (29:24)		default = 0x14	

Addr 0x58 : DC Protection Control 8

Bit	7	6	5	4	3	2	1	0
Name	DCS2							

Name	Description	Value	Meaning	Ref.
DCS2	MDRC RX Checksum (23:16)		default = 0x8E	

Addr 0x59 : DC Protection Control 9

Bit	7	6	5	4	3	2	1	0
Name	DCS1							

Name	Description	Value	Meaning	Ref.
DCS1	MDRC RX Checksum (15:8)		default = 0x9C	

Addr 0x5A : DC Protection Control 10

Bit	7	6	5	4	3	2	1	0
Name	DCS0							

Name	Description	Value	Meaning	Ref.
DCS0	MDRC RX Checksum (7:0)		default = 0x10	

Addr 0x5B : DC Protection Control 11 (read only)

Bit	7	6	5	4	3	2	1	0
Name	X	X	X	X	X	PEF	DEF	MEF

Name	Description	Value	Meaning	Ref.
MEF	Modulation Index Error Flag	b'0		
		b'1	Modulation Index Error	
DEF	DRC Coefficient Error Flag	b'0		
		b'1	MDRC Coefficient Error	
PEF	PEQ Coefficient Error Flag	b'0		
		b'1	PEQ Coefficient Error	

Addr 0x5C : Checksum Download Type Control

Bit	7	6	5	4	3	2	1	0
Name	X	X	X	X	X	X	X	CDT
Name	Description	Value	Meaning					Ref.
CDT	Checksum download type	b'0	1byte * 4 (addr 0x53~0x56, 0x57~0x5A)					
		b'1	4byte (Coefficient mode)					

Addr 0x5D : Driver Control

Bit	7	6	5	4	3	2	1	0
Name	X	X	X	X	X	X	PWM MASK_SEL	SHDN
Name	Description	Value	Meaning					Ref.
SHDN	Shutdown	b'0	SHDN pin go to low					
		b'1	SHDN pin go to high					
PWM MASK_SEL	PWM MASK output select	b'0	PWM_MASK0,1 pin <= PWM_MASK0,1					
		b'1	PWM_MASK0,1 pin <= SHDN					

Reserved Address 0x5E ~ 0x5F

Addr 0x60 : SSR Control 0

Bit	7	6	5	4	3	2	1	0
Name	X	X	DCESW	X	FSFHM	FSFSM	X	X
Name	Description	Value	Meaning					Ref.
FSFSM	frequency stable effect on soft mute flag	b'0	no effect on soft mute flag					
		b'1	soft mute flag = 1 when unstable state					
FSFHM	frequency stable effect on hard mute flag	b'0	no effect on hard mute flag					
		b'1	hard mute flag = 1 when unstable state					
DCESW	DC Check Enable of SRC WCK	b'0	DC Check Disable in SRC WCK					
		b'1	DC Check Enable in SRC WCK					

Addr 0x61 : SSR Control 1

Bit	7	6	5	4	3	2	1	0
Name	X	X	X	X	FVT			
Name	Description	Value	Meaning					Ref.
FVT	Frequency variation threshold	b'0000 ~ b'1111	threshold value for frequency stable check (unsigned integer) default : b'0111					

Reserved Address 0x62 ~ 0x65

Addr 0x66 : I²C Glitch Filter

Bit	7	6	5	4	3	2	1	0
Name	GFO	DUR						
Name	Description	Value	Meaning					Ref.
DUR	glitch width	b'0000000 ~ b'1111111	minimum pulse width = DUR + 20 ns reset default = 15 * 10 ns (DUR default = b'0001111)					
GFO	Glitch filter enable/disable	b'0	Glitch filter on					
		b'1	Bypass					

Reserved Address 0x67

Addr 0x68 : PWM Phase Control

Bit	7	6	5	4	3	2	1	0
Name	PPC				PFC			

Name	Description	Value	Meaning	Ref.
PFC	PWM phase Fine Control	b'0000 ~ b'1001	Range is 0°~14.94° with 1.66° step	In Single ended mode, fixed as PFC = b'0000, and PPC = b'0110 (90°)
PPC	PWM Phase Control	b'0000 ~ b'1100	Range is 0°~180° with 15° step. default = b'0110 (90°)	

Reserved Address 0x69 ~ 0x6D

Addr 0x6E : Watch Dog Error System Status (read only)

Bit	7	6	5	4	3	2	1	0
Name	X	X	X	X	MEF	IWK	IBK	WDE

Name	Description	Value	Meaning	Ref.
WDE	Watch Dog Ratio Error	b'0		
		b'1	Watch Dog Error	
IBK	IIS BCK Ratio Error	b'0		
		b'1	IIS BCK Ratio Error	
IWK	IIS WCK Ratio Error	b'0		
		b'1	IIS WCK Ratio Error	
MEF	Modulation Index Error Flag	b'0		
		b'1	Modulation Index Error	

Addr 0x6F : PWM_MASK Control 5

Bit	7	6	5	4	3	2	1	0
Name	VMSK3	VMSK2	VMSK1	VMSK0	PMSK3	PMSK2	PMSK1	PMSK0

Name	Description	Value	Meaning	Ref.
PMSKn	Masking bit of PWM off control	b'0	Mask bit indicating the validity of n-th bit of Addr 0x6E system register: If the n-th bit of this register is zero, the n-th bit of Addr 0x6E system register is invalid. The n-th bit of Addr 0x6E is valid only when the n-th mask bit is one.	
		b'1		
VMSKn	Masking bit of PWM_MASK signal	b'0		
		b'1		

Addr 0x70 : System Status Register (0x6E, 0x75) Holding Control 1

Bit	7	6	5	4	3	2	1	0
Name	HIWK	HIBK	HWDE	X	HMEF	HMPW	HULCK	X

Name	Description	Value	Meaning	Ref.
HULCK	Enable bit of Holding the ULCK status	b'0	Update the new value without holding the ULCK status bit of 0x75	
		b'1	Hold the first different value	
HMPW	Enable bit of Holding the MPW status	b'0	Update the new value without holding the MPW status bit of 0x75	
		b'1	Hold the first different value	
HMEF	Enable bit of Holding the MEF status	b'0	Update the new value without holding the MEF status bit of 0x6E	
		b'1	Hold the first different value	
HWDE	Enable bit of Holding the WDE status	b'0	Update the new value without holding the WDE status bit of 0x6E	
		b'1	Hold the first different value	
HIBK	Enable bit of Holding the IBK status	b'0	Update the new value without holding the IBK status bit of 0x6E	
		b'1	Hold the first different value	
HIWK	Enable bit of Holding the IWK status	b'0	Update the new value without holding the IWK status bit of 0x6E	
		b'1	Hold the first different value	

Addr 0x71 : POP Control 0

Bit	7	6	5	4	3	2	1	0
Name	RST							

Name	Description	Value	Meaning	Ref.
RST	Release Time	unsigned 0x10	WDE becomes 0 if Watch Dog detects no error during RST*10msec after WDE has been occurred.	

Addr 0x72 : POP Control 1

Bit	7	6	5	4	3	2	1	0
Name	ULM[15:8]							

Name	Description	Value	Meaning	Ref.
ULM		unsigned 0x00	Upper limit on ratio of BCK to CLK_FR_4	

Addr 0x73 : POP Control 2

Bit	7	6	5	4	3	2	1	0
Name	ULM[7:0]							

Name	Description	Value	Meaning	Ref.
ULM	Upper Limit	unsigned 0x20	Upper limit on ratio of BCK to CLK_FR_4	

Addr 0x74 : POP Control 3

Bit	7	6	5	4	3	2	1	0
Name	LLM[3:0]				0	0	0	WON

Name	Description	Value	Meaning	Ref.
LLM	Lower Limit	unsigned b'1001	Lower limit on ratio of BCK to CLK_FR_4	
WON	Watch-dog On	b'0	OFF	
		b'1	ON	

Addr 0x75 : System Error Status (read only)

Bit	7	6	5	4	3	2	1	0
Name	FSI		PSB	PDM		MPW	ULCK	PPM

Name	Description	Value	Meaning	Ref.
PPM	Permanent PWMMASK Indication flag	b'0		
		b'1	Indicated that PWM_MASK is in Permanent LOW state	
ULCK	Sampled PLL Unlock error	b'0	PLL is locked state.	
		b'1	PLL is unlocked state.	
MPW	MCK/WCK Ratio error	b'0	Ratio is incorrect.	
		b'1	Ratio is correct.	
PDM	Power Die Monitor (Temperature, Current, Voltage, Protection Error)	b'00	Current protection error	
		b'01	Voltage protection error	
		b'10	Temperature protection error	
		b'11	Normal state	
PSB	PWM switching on/off State Bit	b'0	PWM switching off state	
		b'1	PWM switching on state	
FSI	Sampling Frequency Information	b'00	48 kHz (44.1kHz)	
		b'01	96 kHz	
		b'10	32 kHz	

Addr 0x76 : Monitor

Bit	7	6	5	4	3	2	1	0
Name	X	X	X	X	Monitor1			

Name	Description	Value	Meaning	Ref.
Monitor 1	This output doesn't come through Power Device.	b'0000	Reserved	
		b'0001	Pwm1a=> Monitor 1 pin	
		b'0010	Pwm1b => Monitor 1 pin	
		b'0011	pwm2a => Monitor 1 pin	
		b'0100	Pwm2b => Monitor 1 pin	
		b'1111	SDATA out => Monitor 1 pin	

Reserved Address 0x77 ~ 0x7B

Addr 0x7C : IIS Sdata_Out Control

Bit	7	6	5	4	3	2	1	0
Name	X	X	X	X	X	X	X	OUT_SEL

Name	Description	Value	Meaning	Ref.
OUT_SEL	Select data for IIS OUT	b'0	Data after soft mute stage is selected	
		b'1	Data before EQ stage is selected	

Reserved Address 0x7D

Addr 0x7E : Bi-Quad Filter Coefficient Page

Bit	7	6	5	4	3	2	1	0
Name	X	X	X	X	APEQ_P	X	CH2	CH1

Name	Description	Value	Meaning	Ref.
CH1	Coefficient write enable	b'0	Disable coefficient write for ch1	
		b'1	Enable coefficient write for ch1	
CH2	Coefficient write enable	b'0	Disable coefficient write for ch2	
		b'1	Enable coefficient write for ch2	
APEQ_P	Coefficient write enable for APEQ Parameters	b'0	Disable coefficient write for APEQ Para.	
		b'1	Enable coefficient write for APEQ Para.	

Note : When writing into BQ1~BQ6 coefficients, Should write for both ch1 and ch2 separately.
 When writing into BQ7~BQ16 coefficients, Just write for ch1.
 (BQ7~BQ16 coefficients are same for both CH1 and CH2)
 When writing into APEQ Parameters, Just write for APEQ_P.

Coefficient Mode:

0x00 ~ 0x31: BQ1 ~BQ10
0x32 ~ 0x4F: QMF_BQ1 ~ 6
0x50 ~ 0x52: Loudness filter gain 1 ~ 3
0x53 ~ 0x57 : Reserved
0x58 : Power Meter Gain
0x59 : Reserved
0x5A : BQ Checksum
0x5B : DRC Checksum
0x5C ~ 0x79: BQ11 ~ BQ16
0x00 ~ 0x24: APEQ Parameters

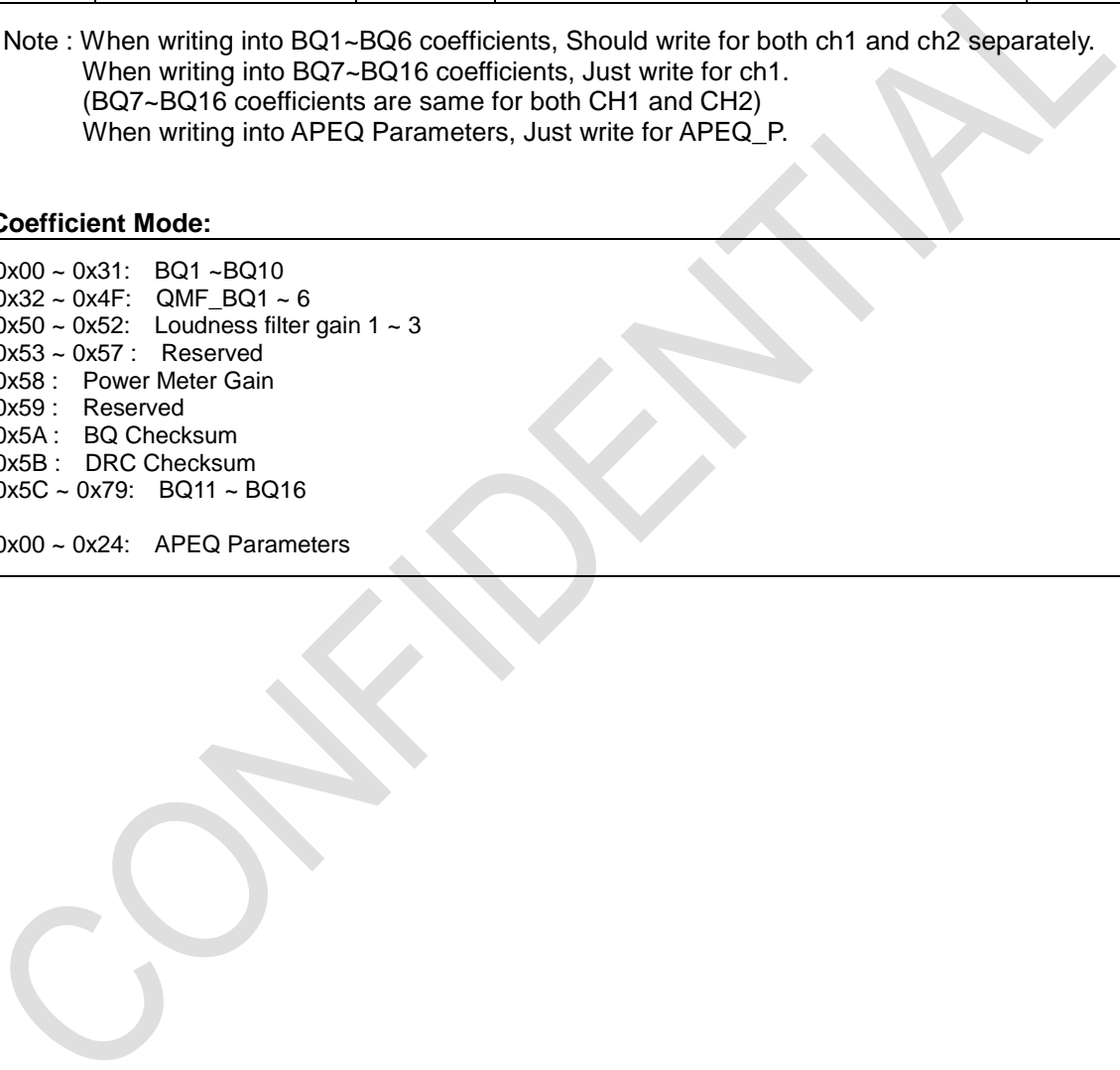

B. Configuration Register Value Reference

Table 16. Master Volume

Index	dB	Index	dB	Index	dB	Index	dB	Index	dB	Index	dB
0xFF	0.0	0xD4	-21.5	0xA9	-43.0	0x7E	-64.5	0x53	-86.0	0x28	-107.5
0xFE	-0.5	0xD3	-22.0	0xA8	-43.5	0x7D	-65.0	0x52	-86.5	0x27	-108.0
0xFD	-1.0	0xD2	-22.5	0xA7	-44.0	0x7C	-65.5	0x51	-87.0	0x26	-108.5
0xFC	-1.5	0xD1	-23.0	0xA6	-44.5	0x7B	-66.0	0x50	-87.5	0x25	-109.0
0xFB	-2.0	0xD0	-23.5	0xA5	-45.0	0x7A	-66.5	0x4F	-88.0	0x24	-109.5
0xFA	-2.5	0xCF	-24.0	0xA4	-45.5	0x79	-67.0	0x4E	-88.5	0x23	-110.0
0xF9	-3.0	0xCE	-24.5	0xA3	-46.0	0x78	-67.5	0x4D	-89.0	0x22	-110.5
0xF8	-3.5	0xCD	-25.0	0xA2	-46.5	0x77	-68.0	0x4C	-89.5	0x21	-111.0
0xF7	-4.0	0xCC	-25.5	0xA1	-47.0	0x76	-68.5	0x4B	-90.0	0x20	-111.5
0xF6	-4.5	0xCB	-26.0	0xA0	-47.5	0x75	-69.0	0x4A	-90.5	0x1F	-112.0
0xF5	-5.0	0xCA	-26.5	0x9F	-48.0	0x74	-69.5	0x49	-91.0	0x1E	-112.5
0xF4	-5.5	0xC9	-27.0	0x9E	-48.5	0x73	-70.0	0x48	-91.5	0x1D	-113.0
0xF3	-6.0	0xC8	-27.5	0x9D	-49.0	0x72	-70.5	0x47	-92.0	0x1C	-113.5
0xF2	-6.5	0xC7	-28.0	0x9C	-49.5	0x71	-71.0	0x46	-92.5	0x1B	-114.0
0xF1	-7.0	0xC6	-28.5	0x9B	-50.0	0x70	-71.5	0x45	-93.0	0x1A	-114.5
0xF0	-7.5	0xC5	-29.0	0x9A	-50.5	0x6F	-72.0	0x44	-93.5	0x19	-115.0
0xEF	-8.0	0xC4	-29.5	0x99	-51.0	0x6E	-72.5	0x43	-94.0	0x18	-115.5
0xEE	-8.5	0xC3	-30.0	0x98	-51.5	0x6D	-73.0	0x42	-94.5	0x17	-116.0
0xED	-9.0	0xC2	-30.5	0x97	-52.0	0x6C	-73.5	0x41	-95.0	0x16	-116.5
0xEC	-9.5	0xC1	-31.0	0x96	-52.5	0x6B	-74.0	0x40	-95.5	0x15	-117.0
0xEB	-10.0	0xC0	-31.5	0x95	-53.0	0x6A	-74.5	0x3F	-96.0	0x14	-117.5
0xEA	-10.5	0xBF	-32.0	0x94	-53.5	0x69	-75.0	0x3E	-96.5	0x13	-118.0
0xE9	-11.0	0xBE	-32.5	0x93	-54.0	0x68	-75.5	0x3D	-97.0	0x12	-118.5
0xE8	-11.5	0xBD	-33.0	0x92	-54.5	0x67	-76.0	0x3C	-97.5	0x11	-119.0
0xE7	-12.0	0xBC	-33.5	0x91	-55.0	0x66	-76.5	0x3B	-98.0	0x10	-119.5
0xE6	-12.5	0xBB	-34.0	0x90	-55.5	0x65	-77.0	0x3A	-98.5	0x0F	-120.0
0xE5	-13.0	0xBA	-34.5	0x8F	-56.0	0x64	-77.5	0x39	-99.0	0x0E	-120.5
0xE4	-13.5	0xB9	-35.0	0x8E	-56.5	0x63	-78.0	0x38	-99.5	0x0D	-121.0
0xE3	-14.0	0xB8	-35.5	0x8D	-57.0	0x62	-78.5	0x37	-100.0	0x0C	-121.5
0xE2	-14.5	0xB7	-36.0	0x8C	-57.5	0x61	-79.0	0x36	-100.5	0x0B	-122.0
0xE1	-15.0	0xB6	-36.5	0x8B	-58.0	0x60	-79.5	0x35	-101.0	0x0A	-122.5
0xE0	-15.5	0xB5	-37.0	0x8A	-58.5	0x5F	-80.0	0x34	-101.5	0x09	-123.0
0xDF	-16.0	0xB4	-37.5	0x89	-59.0	0x5E	-80.5	0x33	-102.0	0x08	-123.5
0xDE	-16.5	0xB3	-38.0	0x88	-59.5	0x5D	-81.0	0x32	-102.5	0x07	-124.0
0xDD	-17.0	0xB2	-38.5	0x87	-60.0	0x5C	-81.5	0x31	-103.0	0x06	-124.5
0xDC	-17.5	0xB1	-39.0	0x86	-60.5	0x5B	-82.0	0x30	-103.5	0x05	-125.0
0xDB	-18.0	0xB0	-39.5	0x85	-61.0	0x5A	-82.5	0x2F	-104.0	0x04	-125.5
0xDA	-18.5	0xAF	-40.0	0x84	-61.5	0x59	-83.0	0x2E	-104.5	0x03	NA
0xD9	-19.0	0xAE	-40.5	0x83	-62.0	0x58	-83.5	0x2D	-105.0	0x02	NA
0xD8	-19.5	0xAD	-41.0	0x82	-62.5	0x57	-84.0	0x2C	-105.5	0x01	NA
0xD7	-20.0	0xAC	-41.5	0x81	-63.0	0x56	-84.5	0x2B	-106.0	0x00	NA
0xD6	-20.5	0xAB	-42.0	0x80	-63.5	0x55	-85.0	0x2A	-106.5		
0xD5	-21.0	0xAA	-42.5	0x7F	-64.0	0x54	-85.5	0x29	-107.0		

Table 17. Channel Volume

Index	dB	Index	dB	Index	dB	Index	dB	Index	dB	Index	dB
0xFF	48.0	0xD4	26.5	0xA9	5.0	0x7E	-16.5	0x53	-38.0	0x28	-59.5
0xFE	47.5	0xD3	26.0	0xA8	4.5	0x7D	-17.0	0x52	-38.5	0x27	-60.0
0xFD	47.0	0xD2	25.5	0xA7	4.0	0x7C	-17.5	0x51	-39.0	0x26	-60.5
0xFC	46.5	0xD1	25.0	0xA6	3.5	0x7B	-18.0	0x50	-39.5	0x25	-61.0
0xFB	46.0	0xD0	24.5	0xA5	3.0	0x7A	-18.5	0x4F	-40.0	0x24	-61.5
0xFA	45.5	0xCF	24.0	0xA4	2.5	0x79	-19.0	0x4E	-40.5	0x23	-62.0
0xF9	45.0	0xCE	23.5	0xA3	2.0	0x78	-19.5	0x4D	-41.0	0x22	-62.5
0xF8	44.5	0xCD	23.0	0xA2	1.5	0x77	-20.0	0x4C	-41.5	0x21	-63.0
0xF7	44.0	0xCC	22.5	0xA1	1.0	0x76	-20.5	0x4B	-42.0	0x20	-63.5
0xF6	43.5	0xCB	22.0	0xA0	0.5	0x75	-21.0	0x4A	-42.5	0x1F	-64.0
0xF5	43.0	0xCA	21.5	0x9F	0.0	0x74	-21.5	0x49	-43.0	0x1E	-64.5
0xF4	42.5	0xC9	21.0	0x9E	-0.5	0x73	-22.0	0x48	-43.5	0x1D	-65.0
0xF3	42.0	0xC8	20.5	0x9D	-1.0	0x72	-22.5	0x47	-44.0	0x1C	-65.5
0xF2	41.5	0xC7	20.0	0x9C	-1.5	0x71	-23.0	0x46	-44.5	0x1B	-66.0
0xF1	41.0	0xC6	19.5	0x9B	-2.0	0x70	-23.5	0x45	-45.0	0x1A	-66.5
0xF0	40.5	0xC5	19.0	0x9A	-2.5	0x6F	-24.0	0x44	-45.5	0x19	-67.0
0xEF	40.0	0xC4	18.5	0x99	-3.0	0x6E	-24.5	0x43	-46.0	0x18	-67.5
0xEE	39.5	0xC3	18.0	0x98	-3.5	0x6D	-25.0	0x42	-46.5	0x17	-68.0
0xED	39.0	0xC2	17.5	0x97	-4.0	0x6C	-25.5	0x41	-47.0	0x16	-68.5
0xEC	38.5	0xC1	17.0	0x96	-4.5	0x6B	-26.0	0x40	-47.5	0x15	-69.0
0xEB	38.0	0xC0	16.5	0x95	-5.0	0x6A	-26.5	0x3F	-48.0	0x14	-69.5
0xEA	37.5	0xBF	16.0	0x94	-5.5	0x69	-27.0	0x3E	-48.5	0x13	-70.0
0xE9	37.0	0xBE	15.5	0x93	-6.0	0x68	-27.5	0x3D	-49.0	0x12	-70.5
0xE8	36.5	0xBD	15.0	0x92	-6.5	0x67	-28.0	0x3C	-49.5	0x11	-71.0
0xE7	36.0	0xBC	14.5	0x91	-7.0	0x66	-28.5	0x3B	-50.0	0x10	-71.5
0xE6	35.5	0xBB	14.0	0x90	-7.5	0x65	-29.0	0x3A	-50.5	0x0F	-72.0
0xE5	35.0	0xBA	13.5	0x8F	-8.0	0x64	-29.5	0x39	-51.0	0x0E	-72.5
0xE4	34.5	0xB9	13.0	0x8E	-8.5	0x63	-30.0	0x38	-51.5	0x0D	-73.0
0xE3	34.0	0xB8	12.5	0x8D	-9.0	0x62	-30.5	0x37	-52.0	0x0C	-73.5
0xE2	33.5	0xB7	12.0	0x8C	-9.5	0x61	-31.0	0x36	-52.5	0x0B	-74.0
0xE1	33.0	0xB6	11.5	0x8B	-10.0	0x60	-31.5	0x35	-53.0	0x0A	-74.5
0xE0	32.5	0xB5	11.0	0x8A	-10.5	0x5F	-32.0	0x34	-53.5	0x09	-75.0
0xDF	32.0	0xB4	10.5	0x89	-11.0	0x5E	-32.5	0x33	-54.0	0x08	-75.5
0xDE	31.5	0xB3	10.0	0x88	-11.5	0x5D	-33.0	0x32	-54.5	0x07	-76.0
0xDD	31.0	0xB2	9.5	0x87	-12.0	0x5C	-33.5	0x31	-55.0	0x06	-76.5
0xDC	30.5	0xB1	9.0	0x86	-12.5	0x5B	-34.0	0x30	-55.5	0x05	-77.0
0xDB	30.0	0xB0	8.5	0x85	-13.0	0x5A	-34.5	0x2F	-56.0	0x04	-77.5
0xDA	29.5	0xAF	8.0	0x84	-13.5	0x59	-35.0	0x2E	-56.5	0x03	-78.0
0xD9	29.0	0xAE	7.5	0x83	-14.0	0x58	-35.5	0x2D	-57.0	0x02	-78.5
0xD8	28.5	0xAD	7.0	0x82	-14.5	0x57	-36.0	0x2C	-57.5	0x01	-79.0
0xD7	28.0	0xAC	6.5	0x81	-15.0	0x56	-36.5	0x2B	-58.0	0x00	-295.0
0xD6	27.5	0xAB	6.0	0x80	-15.5	0x55	-37.0	0x2A	-58.5		
0xD5	27.0	0xAA	5.5	0x7F	-16.0	0x54	-37.5	0x29	-59.0		

Table 18. Mixer Gain & Polarity

Index	Polarity	dB	Index	Polarity	dB	Index	Polarity	dB	Index	Polarity	dB
7E	+	18	7D	-	18	3E	+	-4	3D	-	-4
7C	+	17	7B	-	17	3C	+	-4.5	3B	-	-4.5
7A	+	16	79	-	16	3A	+	-5	39	-	-5
78	+	15	77	-	15	38	+	-5.5	37	-	-5.5
76	+	14	75	-	14	36	+	-6	35	-	-6
74	+	13	73	-	13	34	+	-7	33	-	-7
72	+	12	71	-	12	32	+	-8	31	-	-8
70	+	11	6F	-	11	30	+	-9	2F	-	-9
6E	+	10	6D	-	10	2E	+	-10	2D	-	-10
6C	+	9	6B	-	9	2C	+	-11	2B	-	-11
6A	+	8	69	-	8	2A	+	-12	29	-	-12
68	+	7	67	-	7	28	+	-13	27	-	-13
66	+	6	65	-	6	26	+	-14	25	-	-14
64	+	5.5	63	-	5.5	24	+	-15	23	-	-15
62	+	5	61	-	5	22	+	-16	21	-	-16
60	+	4.5	5F	-	4.5	20	+	-17	1F	-	-17
5E	+	4	5D	-	4	1E	+	-18	1D	-	-18
5C	+	3.5	5B	-	3.5	1C	+	-19	1B	-	-19
5A	+	3	59	-	3	1A	+	-20	19	-	-20
58	+	2.5	57	-	2.5	18	+	-21	17	-	-21
56	+	2	55	-	2	16	+	-22	15	-	-22
54	+	1.5	53	-	1.5	14	+	-23	13	-	-23
52	+	1	51	-	1	12	+	-24	11	-	-24
50	+	0.5	4F	-	0.5	10	+	-25	0F	-	-25
4E	+	0	4D	-	0	0E	+	-26	0D	-	-26
4C	+	-0.5	4B	-	-0.5	0C	+	-27	0B	-	-27
4A	+	-1	49	-	-1	0A	+	-28	09	-	-28
48	+	-1.5	47	-	-1.5	08	+	-29	07	-	-29
46	+	-2	45	-	-2	06	+	-30	05	-	-30
44	+	-2.5	43	-	-2.5	04	+	-31	03	-	-31
42	+	-3	41	-	-3	02	+	-32	01	-	-32
40	+	-3.5	3F	-	-3.5	00	+	-150			

Table 19. Dynamic Range Control Threshold

dB	Value	dB	Value	dB	Value	dB	Value
-57	FF	-5.5	DF	-2.3	BF	0.9	9F
-54	FE	-5.4	DE	-2.2	BE	1	9E
-51	FD	-5.3	DD	-2.1	BD	1.25	9D
-48	FC	-5.2	DC	-2	BC	1.5	9C
-45	FB	-5.1	DB	-1.9	BB	1.75	9B
-42	FA	-5	DA	-1.8	BA	2	9A
-39	F9	-4.9	D9	-1.7	B9	2.25	99
-36	F8	-4.8	D8	-1.6	B8	2.5	98
-33	F7	-4.7	D7	-1.5	B7	2.75	97
-30	F6	-4.6	D6	-1.4	B6	3	96
-27	F5	-4.5	D5	-1.3	B5	3.25	95
-24	F4	-4.4	D4	-1.2	B4	3.5	94
-21	F3	-4.3	D3	-1.1	B3	3.75	93
-18	F2	-4.2	D2	-1	B2	4	92
-15	F1	-4.1	D1	-0.9	B1	4.25	91
-12	F0	-4	D0	-0.8	B0	4.5	90
-11.5	EF	-3.9	CF	-0.7	AF	4.75	8F
-11	EE	-3.8	CE	-0.6	AE	5	8E
-10.5	ED	-3.7	CD	-0.5	AD	5.5	8D
-10	EC	-3.6	CC	-0.4	AC	6	8C
-9.5	EB	-3.5	CB	-0.3	AB	6.5	8B
-9	EA	-3.4	CA	-0.2	AA	7	8A
-8.5	E9	-3.3	C9	-0.1	A9	7.5	89
-8	E8	-3.2	C8	0	A8	8	88
-7.5	E7	-3.1	C7	0.1	A7	8.5	87
-7	E6	-3	C6	0.2	A6	9	86
-6.5	E5	-2.9	C5	0.3	A5	9.5	85
-6	E4	-2.8	C4	0.4	A4	10	84
-5.9	E3	-2.7	C3	0.5	A3	10.5	83
-5.8	E2	-2.6	C2	0.6	A2	11	82
-5.7	E1	-2.5	C1	0.7	A1	11.5	81
-5.6	E0	-2.4	C0	0.8	A0	12	80

※ CPR bit(MSB) = 1

Table 20. Auto Mute Detection Threshold Table

Name	Description	Value	dB
AT	Auto-mute Detection threshold	0000	-126
		0001	-120
		0010	-114
		0011	-108
		0100	-102
		0101	-96
		0110	-90
		0111	-84
		1000	-78
		1001	-72
		1010	-66
		1011	-60
		1100	-54
		1101	-48
		1110	-42
		1111	Auto-mute

※ Do not use value 1111.

CONFIDENTIAL

Table 21. Power Meter Reading Table

addr 0x54 (Decimal)	addr 0x54 (Hex)	dB	addr 0x54 (Decimal)	addr 0x54 (Hex)	dB	addr 0x54 (Decimal)	addr 0x54 (Hex)	dB	addr 0x54 (Decimal)	addr 0x54 (Hex)	dB
0	0x00	-0.0	64	0x40	-32.0	128	0x80	-64.0	192	0xC0	-96.0
1	0x01	-0.5	65	0x41	-32.5	129	0x81	-64.5	193	0xC1	-96.5
2	0x02	-1.0	66	0x42	-33.0	130	0x82	-65.0	194	0xC2	-97.0
3	0x03	-1.5	67	0x43	-33.5	131	0x83	-65.5	195	0xC3	-97.5
4	0x04	-2.0	68	0x44	-34.0	132	0x84	-66.0	196	0xC4	-98.0
5	0x05	-2.5	69	0x45	-34.5	133	0x85	-66.5	197	0xC5	-98.5
6	0x06	-3.0	70	0x46	-35.0	134	0x86	-67.0	198	0xC6	-99.0
7	0x07	-3.5	71	0x47	-35.5	135	0x87	-67.5	199	0xC7	-99.5
8	0x08	-4.0	72	0x48	-36.0	136	0x88	-68.0	200	0xC8	-100.0
9	0x09	-4.5	73	0x49	-36.5	137	0x89	-68.5	201	0xC9	-100.5
10	0x0A	-5.0	74	0x4A	-37.0	138	0x8A	-69.0	202	0xCA	-101.0
11	0x0B	-5.5	75	0x4B	-37.5	139	0x8B	-69.5	203	0xCB	-101.5
12	0x0C	-6.0	76	0x4C	-38.0	140	0x8C	-70.0	204	0xCC	-102.0
13	0x0D	-6.5	77	0x4D	-38.5	141	0x8D	-70.5	205	0xCD	-102.5
14	0x0E	-7.0	78	0x4E	-39.0	142	0x8E	-71.0	206	0xCE	-103.0
15	0x0F	-7.5	79	0x4F	-39.5	143	0x8F	-71.5	207	0xCF	-103.5
16	0x10	-8.0	80	0x50	-40.0	144	0x90	-72.0	208	0xD0	-104.0
17	0x11	-8.5	81	0x51	-40.5	145	0x91	-72.5	209	0xD1	-104.5
18	0x12	-9.0	82	0x52	-41.0	146	0x92	-73.0	210	0xD2	-105.0
19	0x13	-9.5	83	0x53	-41.5	147	0x93	-73.5	211	0xD3	-105.5
20	0x14	-10.0	84	0x54	-42.0	148	0x94	-74.0	212	0xD4	-106.0
21	0x15	-10.5	85	0x55	-42.5	149	0x95	-74.5	213	0xD5	-106.5
22	0x16	-11.0	86	0x56	-43.0	150	0x96	-75.0	214	0xD6	-107.0
23	0x17	-11.5	87	0x57	-43.5	151	0x97	-75.5	215	0xD7	-107.5
24	0x18	-12.0	88	0x58	-44.0	152	0x98	-76.0	216	0xD8	-108.0
25	0x19	-12.5	89	0x59	-44.5	153	0x99	-76.5	217	0xD9	-108.5
26	0x1A	-13.0	90	0x5A	-45.0	154	0x9A	-77.0	218	0xDA	-109.0
27	0x1B	-13.5	91	0x5B	-45.5	155	0x9B	-77.5	219	0xDB	-109.5
28	0x1C	-14.0	92	0x5C	-46.0	156	0x9C	-78.0	220	0xDC	-110.0
29	0x1D	-14.5	93	0x5D	-46.5	157	0x9D	-78.5	221	0xDD	-110.5
30	0x1E	-15.0	94	0x5E	-47.0	158	0x9E	-79.0	222	0xDE	-111.0
31	0x1F	-15.5	95	0x5F	-47.5	159	0x9F	-79.5	223	0xDF	-111.5
32	0x20	-16.0	96	0x60	-48.0	160	0xA0	-80.0	224	0xE0	-112.0
33	0x21	-16.5	97	0x61	-48.5	161	0xA1	-80.5	225	0xE1	-112.5
34	0x22	-17.0	98	0x62	-49.0	162	0xA2	-81.0	226	0xE2	-113.0
35	0x23	-17.5	99	0x63	-49.5	163	0xA3	-81.5	227	0xE3	-113.5
36	0x24	-18.0	100	0x64	-50.0	164	0xA4	-82.0	228	0xE4	-114.0
37	0x25	-18.5	101	0x65	-50.5	165	0xA5	-82.5	229	0xE5	-114.5
38	0x26	-19.0	102	0x66	-51.0	166	0xA6	-83.0	230	0xE6	-115.0
39	0x27	-19.5	103	0x67	-51.5	167	0xA7	-83.5	231	0xE7	-115.5
40	0x28	-20.0	104	0x68	-52.0	168	0xA8	-84.0	232	0xE8	-116.0
41	0x29	-20.5	105	0x69	-52.5	169	0xA9	-84.5	233	0xE9	-116.5
42	0x2A	-21.0	106	0x6A	-53.0	170	0xAA	-85.0	234	0xEA	-117.0
43	0x2B	-21.5	107	0x6B	-53.5	171	0xAB	-85.5	235	0xEB	-117.5
44	0x2C	-22.0	108	0x6C	-54.0	172	0xAC	-86.0	236	0xEC	-118.0
45	0x2D	-22.5	109	0x6D	-54.5	173	0xAD	-86.5	237	0xED	-118.5
46	0x2E	-23.0	110	0x6E	-55.0	174	0xAE	-87.0	238	0xEE	-119.0
47	0x2F	-23.5	111	0x6F	-55.5	175	0xAF	-87.5	239	0xEF	-119.5
48	0x30	-24.0	112	0x70	-56.0	176	0xB0	-88.0	240	0xF0	-120.0
49	0x31	-24.5	113	0x71	-56.5	177	0xB1	-88.5	241	0xF1	-120.5
50	0x32	-25.0	114	0x72	-57.0	178	0xB2	-89.0	242	0xF2	-121.0
51	0x33	-25.5	115	0x73	-57.5	179	0xB3	-89.5	243	0xF3	-121.5
52	0x34	-26.0	116	0x74	-58.0	180	0xB4	-90.0	244	0xF4	-122.0
53	0x35	-26.5	117	0x75	-58.5	181	0xB5	-90.5	245	0xF5	-122.5
54	0x36	-27.0	118	0x76	-59.0	182	0xB6	-91.0	246	0xF6	-123.0
55	0x37	-27.5	119	0x77	-59.5	183	0xB7	-91.5	247	0xF7	-123.5
56	0x38	-28.0	120	0x78	-60.0	184	0xB8	-92.0	248	0xF8	-124.0
57	0x39	-28.5	121	0x79	-60.5	185	0xB9	-92.5	249	0xF9	-124.5
58	0x3A	-29.0	122	0x7A	-61.0	186	0xBA	-93.0	250	0xFA	-125.0
59	0x3B	-29.5	123	0x7B	-61.5	187	0xBB	-93.5	251	0xFB	-125.5
60	0x3C	-30.0	124	0x7C	-62.0	188	0xBC	-94.0	252	0xFC	-126.0
61	0x3D	-30.5	125	0x7D	-62.5	189	0xBD	-94.5	253	0xFD	-126.5
62	0x3E	-31.0	126	0x7E	-63.0	190	0xBE	-95.0	254	0xFE	-127.0
63	0x3F	-31.5	127	0x7F	-63.5	191	0xBF	-95.5	255	0xFF	-127.5 under

※ Output 8bit value : (-dB * 2), n dB = output 8bit *0.5

C. Typical Characteristics Graph

Test Condition : 4Layer Board

Total Harmonic Distortion + Noise vs. Power, BTL D-BTL Mode Configuration, 8Ω

THD+N vs. Power

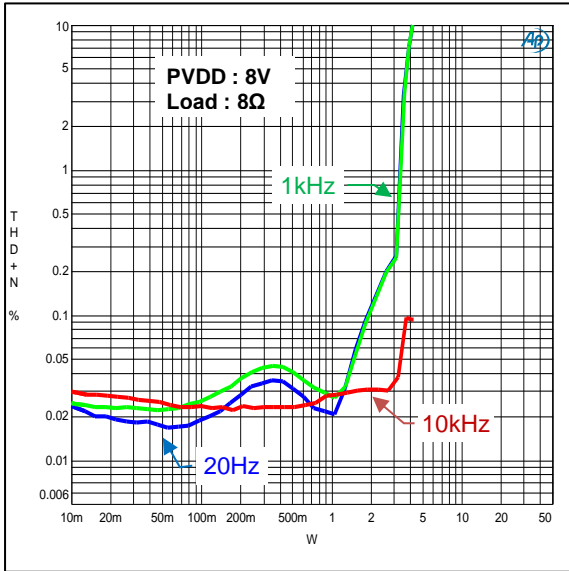

THD+N vs. Power

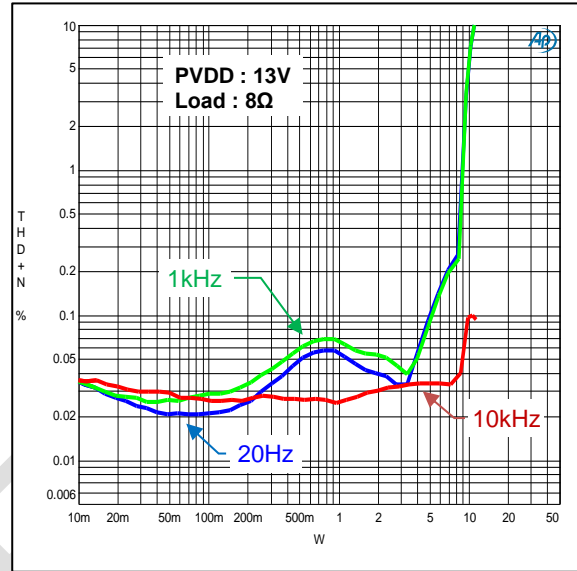

THD+N vs. Power

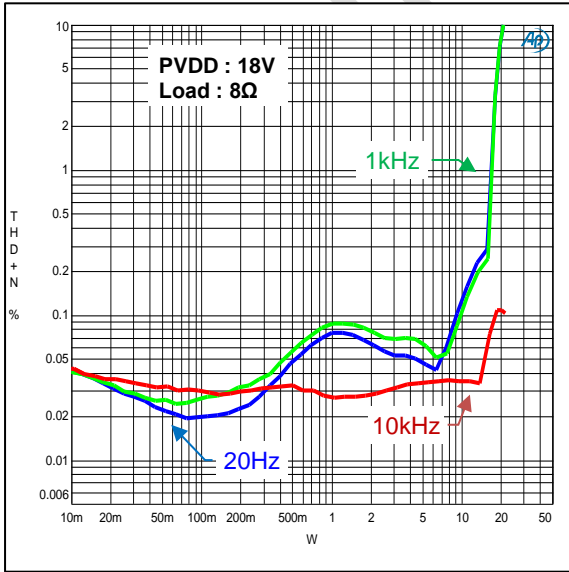

THD+N vs. Power

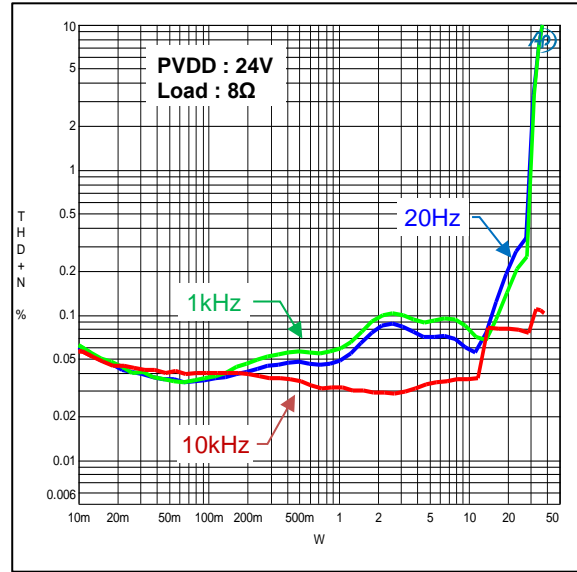

Total Harmonic Distortion + Noise vs. Power, BTL D-BTL Mode Configuration, 6Ω

THD+N vs. Power

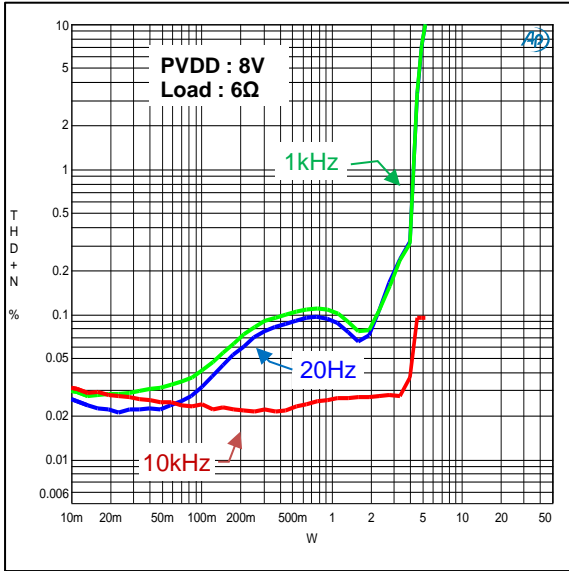

THD+N vs. Power

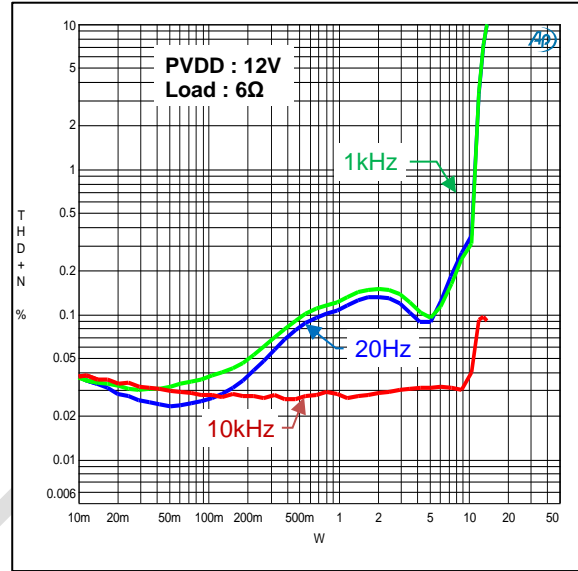

THD+N vs. Power

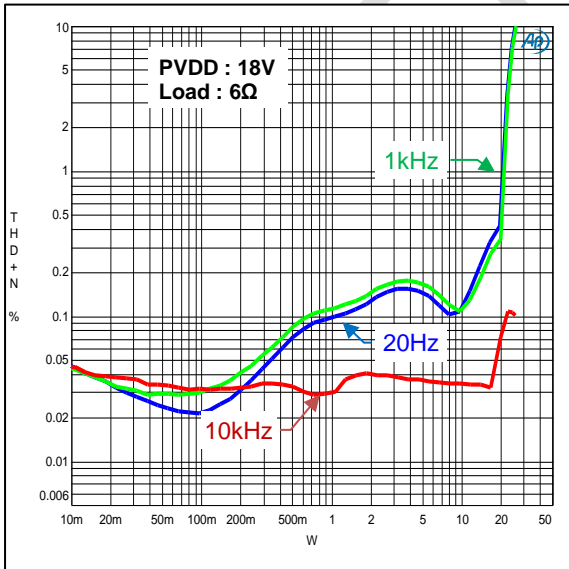

THD+N vs. Power

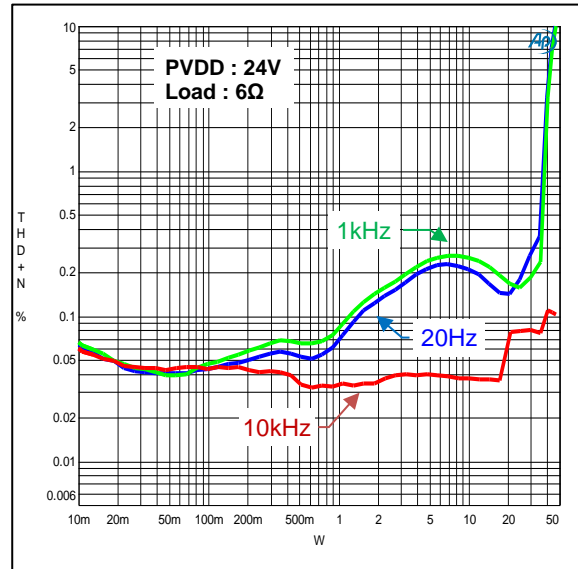

Total Harmonic Distortion + Noise vs. Power, BTL D-BTL Mode Configuration, 4Ω

THD+N vs. Power

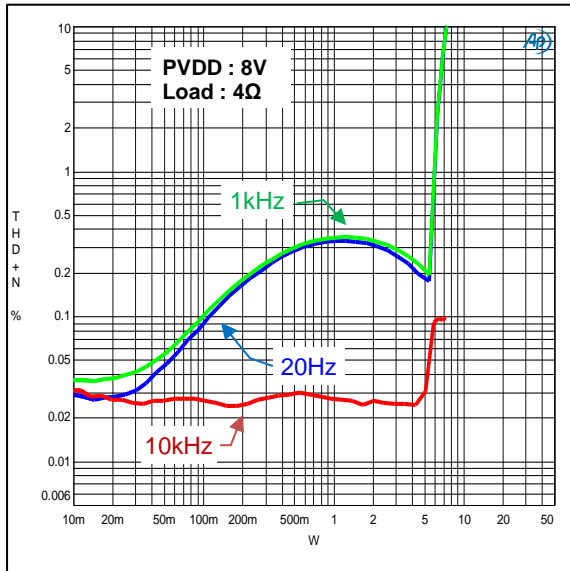

THD+N vs. Power

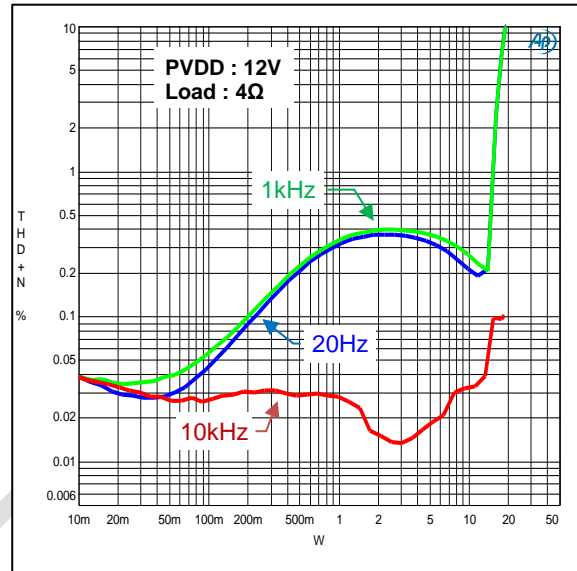

THD+N vs. Power

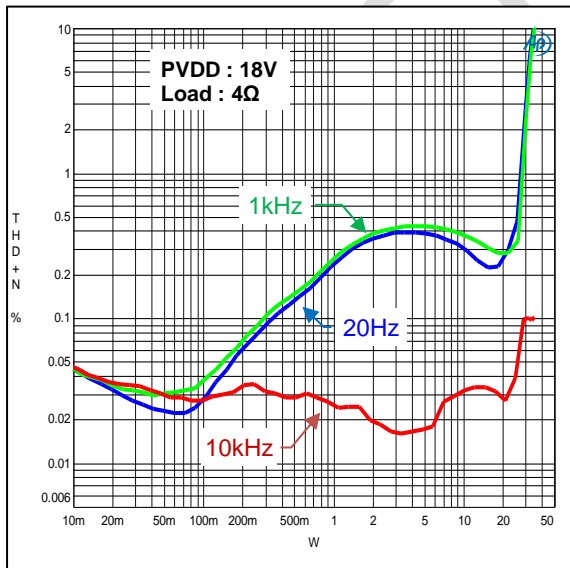

Total Harmonic Distortion + Noise vs. Frequency, BTL D-BTL Mode Configuration, 8Ω

THD+N vs. Frequency

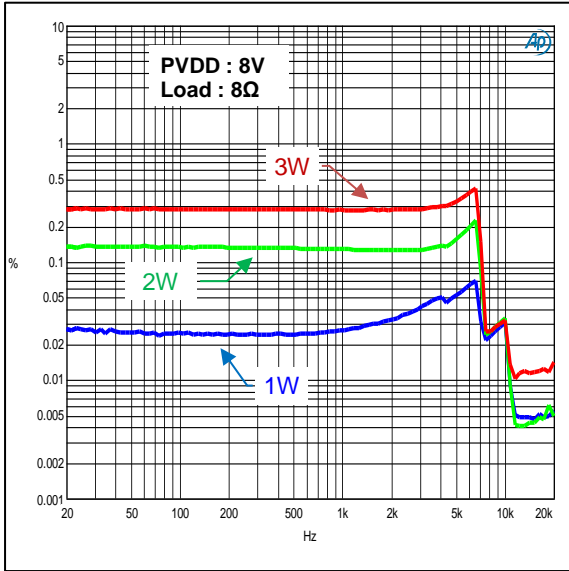

THD+N vs. Frequency

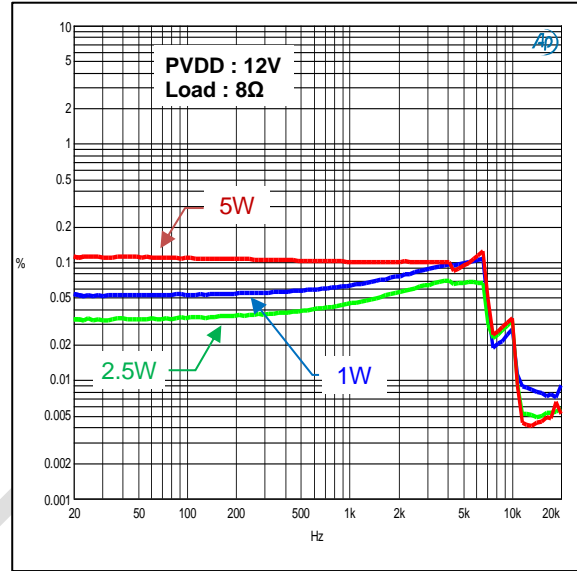

THD+N vs. Frequency

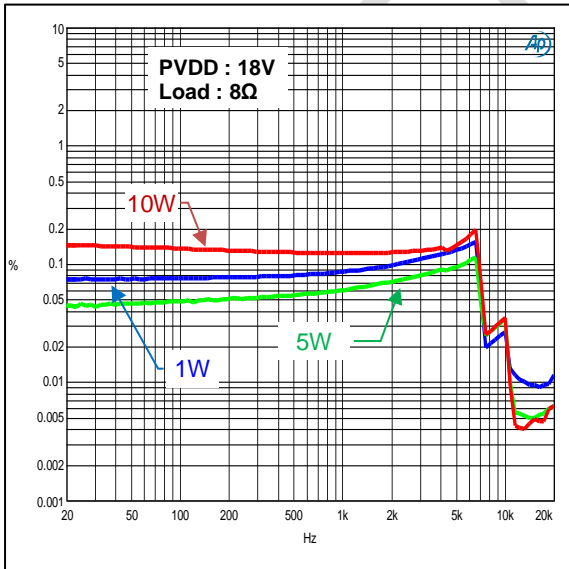

THD+N vs. Frequency

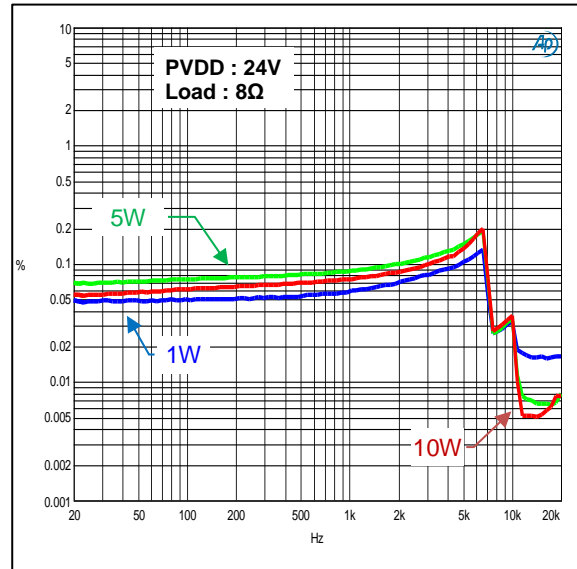

Total Harmonic Distortion + Noise vs. Frequency, BTL D-BTL Mode Configuration, 6Ω

THD+N vs. Frequency

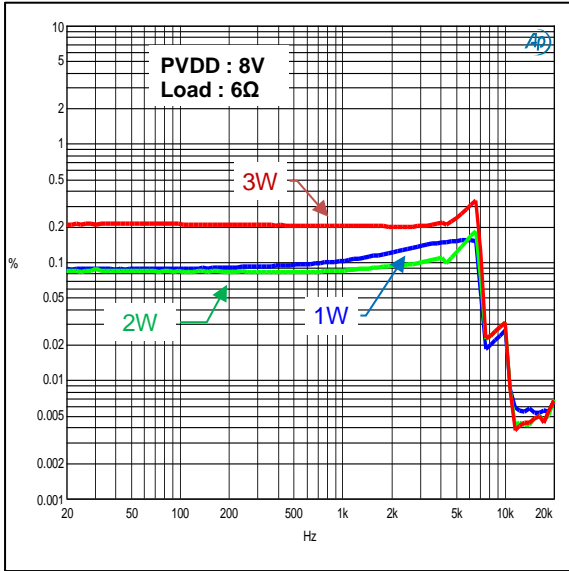

THD+N vs. Frequency

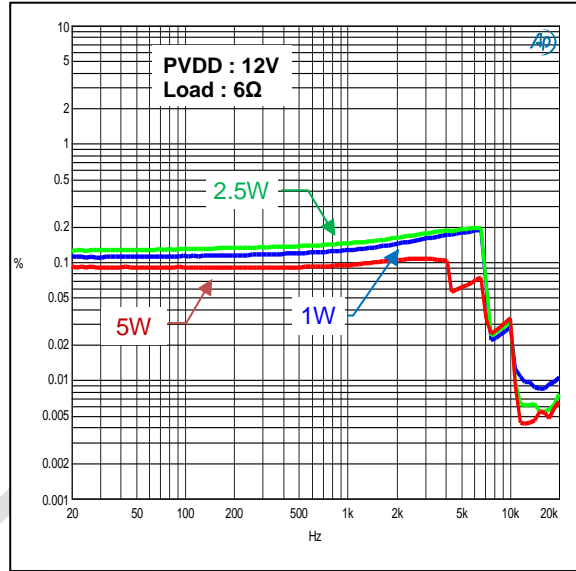

THD+N vs. Frequency

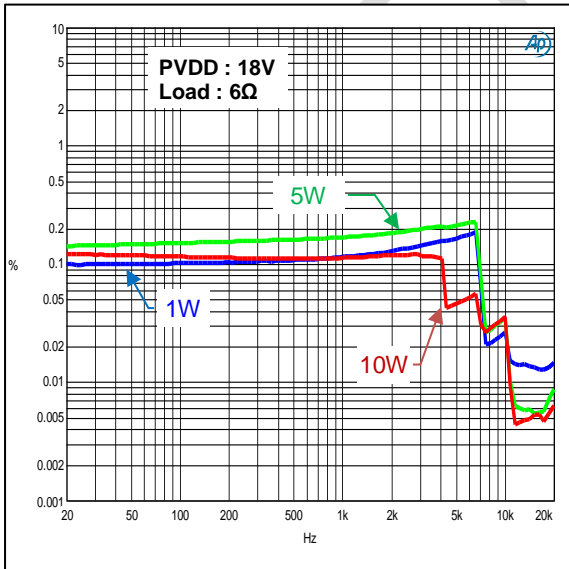

THD+N vs. Frequency

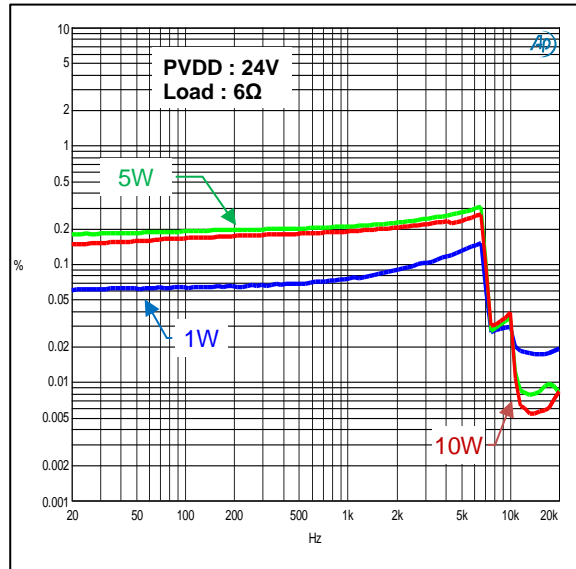

Total Harmonic Distortion + Noise vs. Frequency, BTL D-BTL Mode Configuration, 4Ω

THD+N vs. Frequency

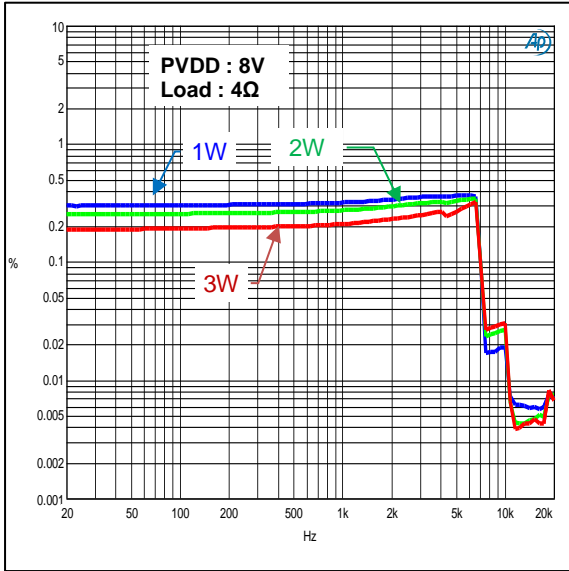

THD+N vs. Frequency

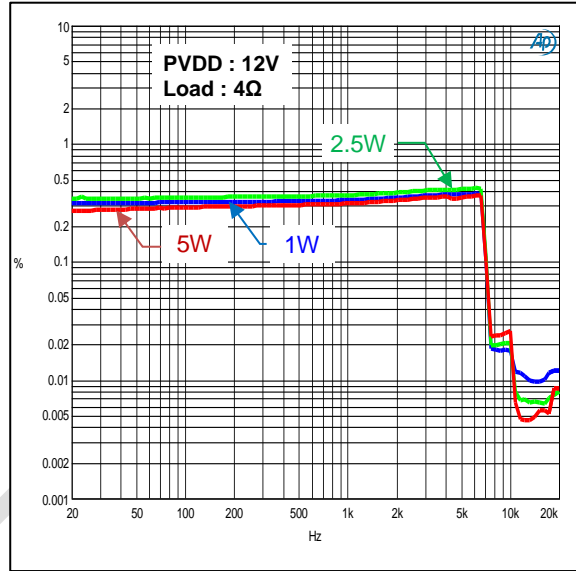

THD+N vs. Frequency

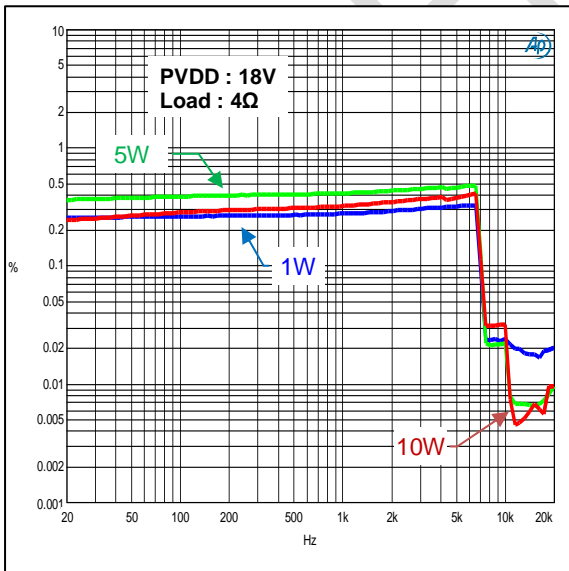

THD+N vs. Frequency

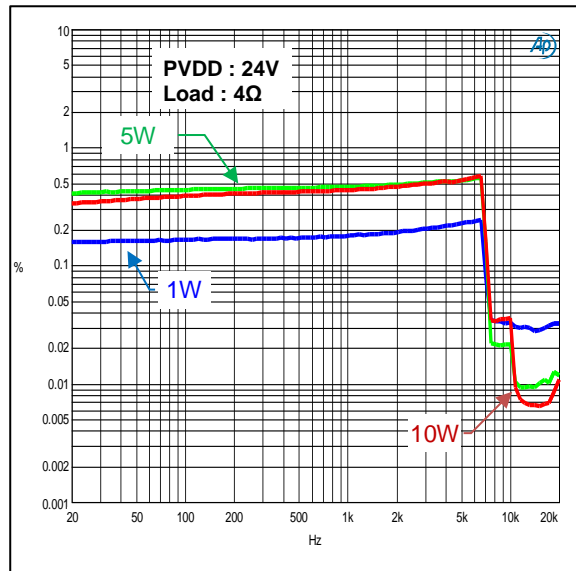

Output Power vs. PVDD, BTL D-BTL Mode Configuration

Output Power vs. PVDD

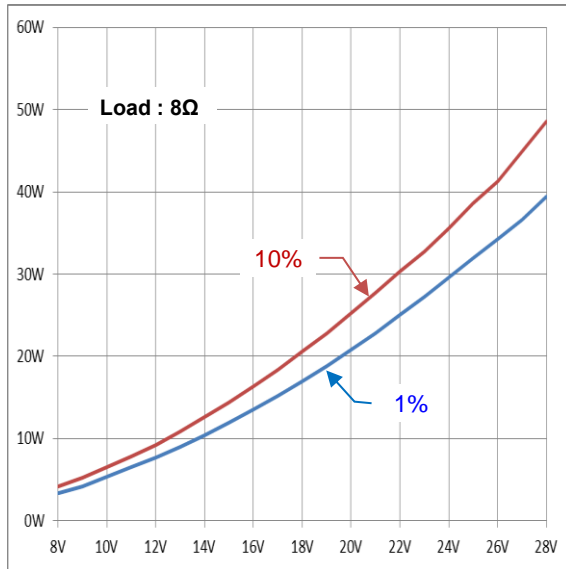

Output Power vs. PVDD

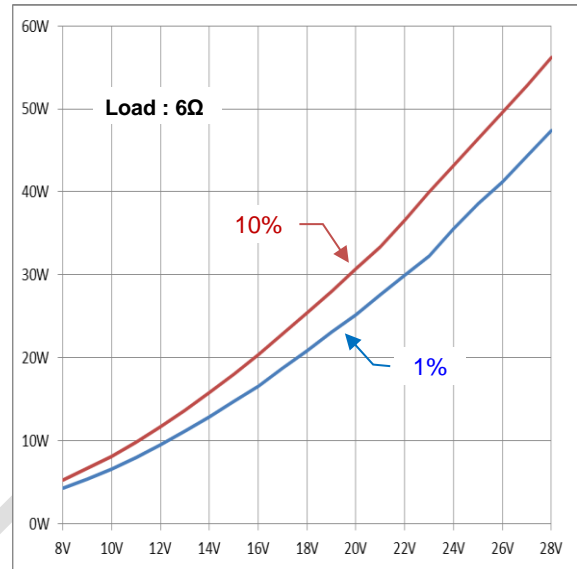

Output Power vs. PVDD

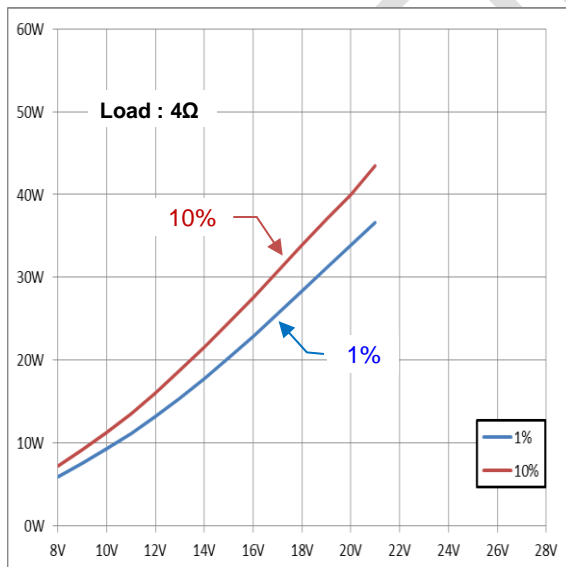

Efficiency vs. Total Power, BTL D-BTL Mode Configuration

Efficiency vs. Output Power

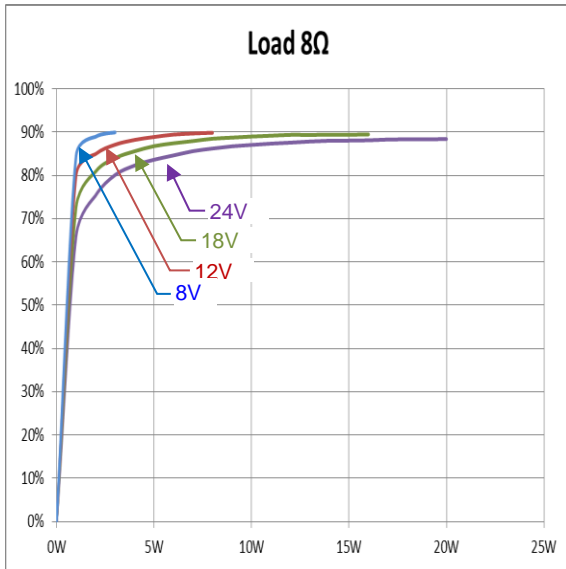

Efficiency vs. Output Power

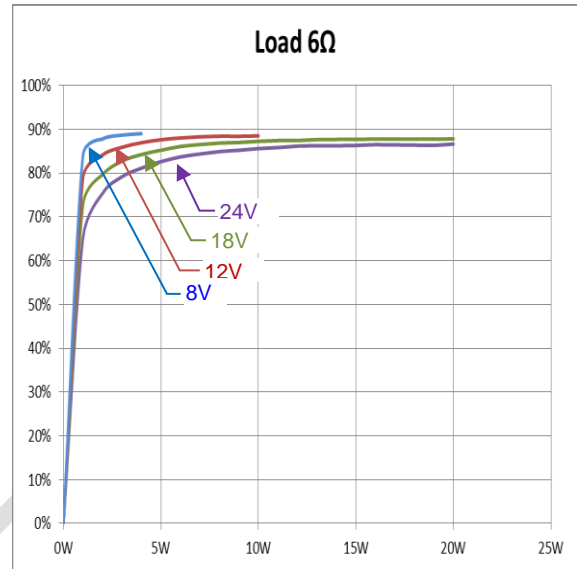

Efficiency vs. Output Power

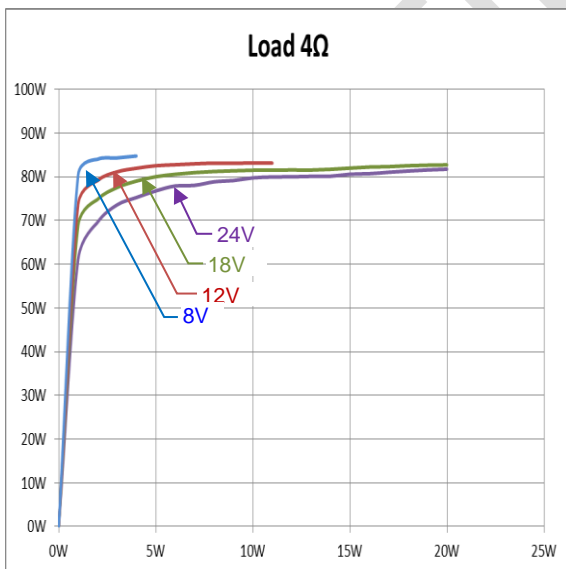

Total Harmonic Distortion + Noise vs. Power, PBTL DBTL Mode Configuration, 4Ω

THD+N vs. Power

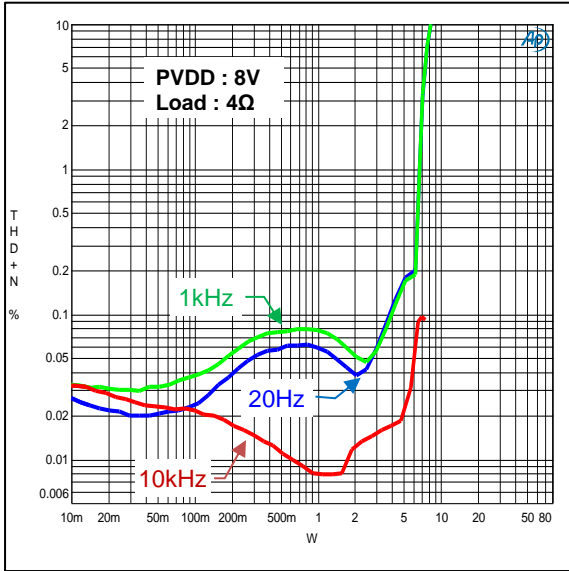

THD+N vs. Power

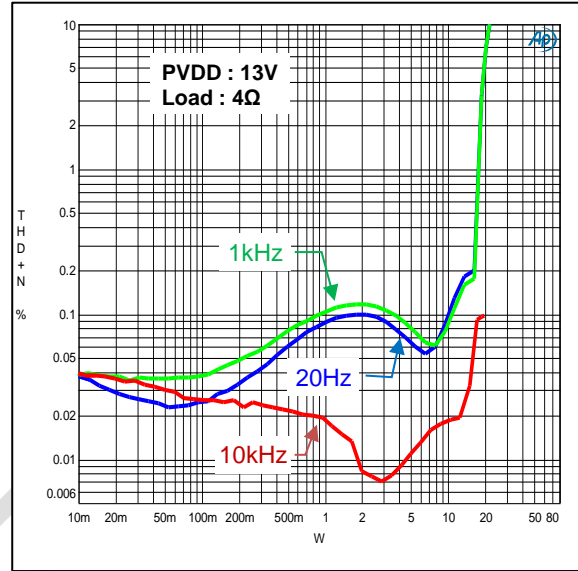

THD+N vs. Power

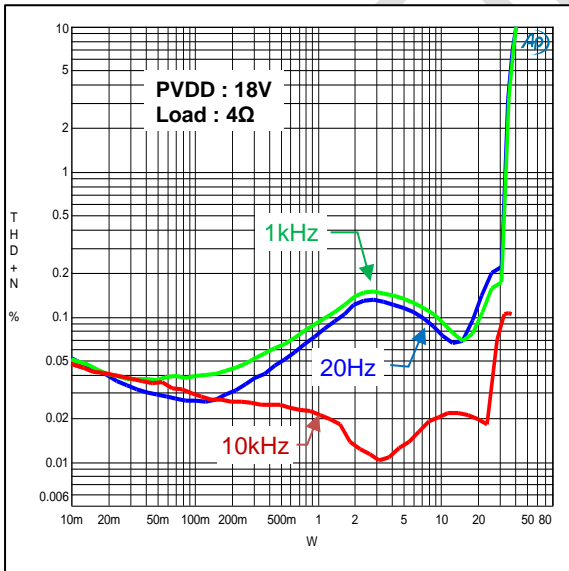

THD+N vs. Power

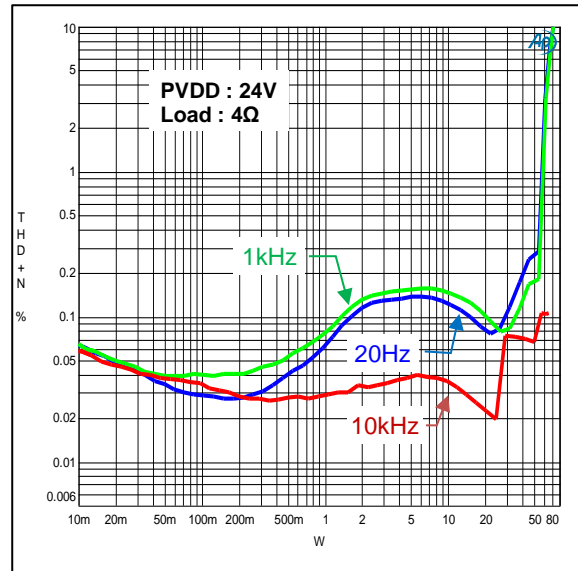

Total Harmonic Distortion + Noise vs. Frequency, PBTl DBTL Mode Configuration, 4Ω

THD+N vs. Frequency

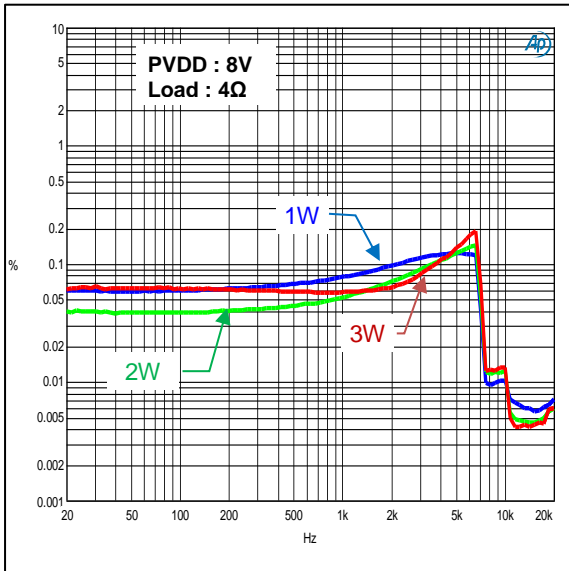

THD+N vs. Frequency

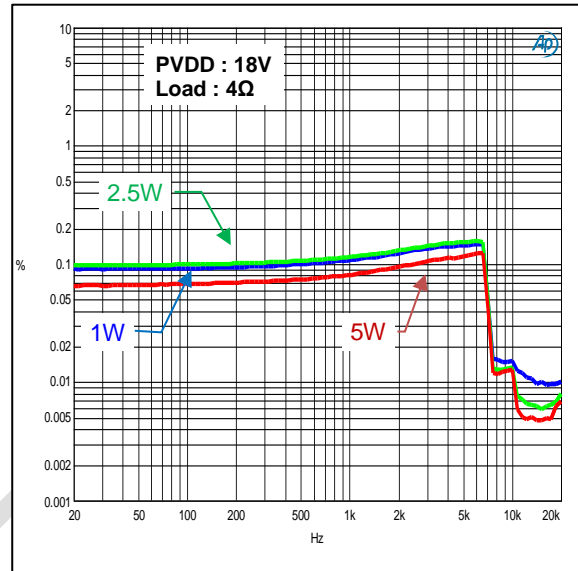

THD+N vs. Frequency

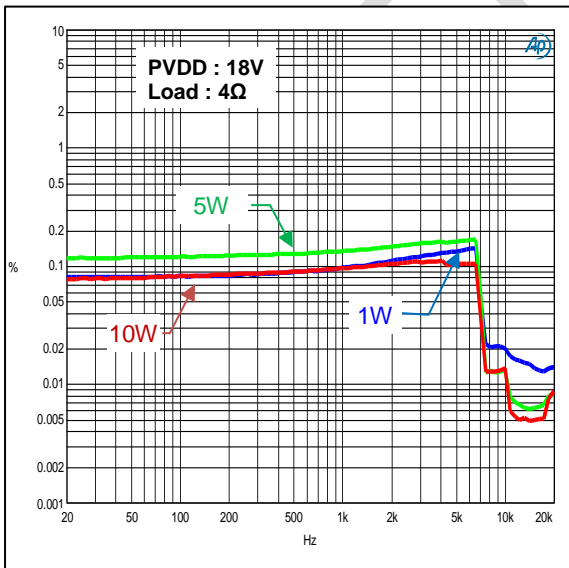

THD+N vs. Frequency

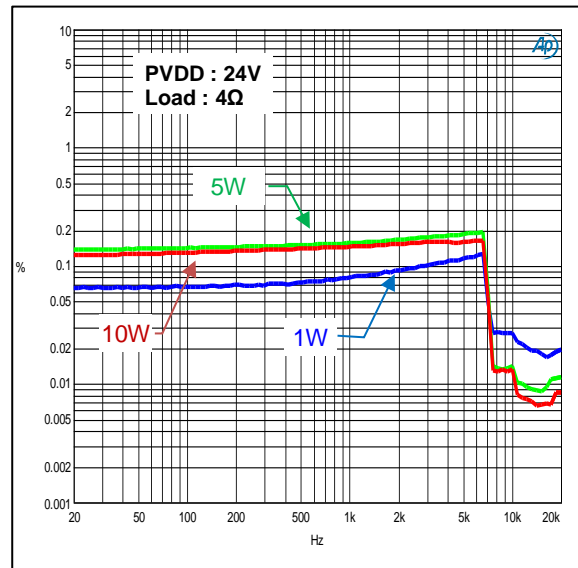

Output Power vs. PVDD, PBTL DBTL Mode Configuration

Output Power vs. PVDD

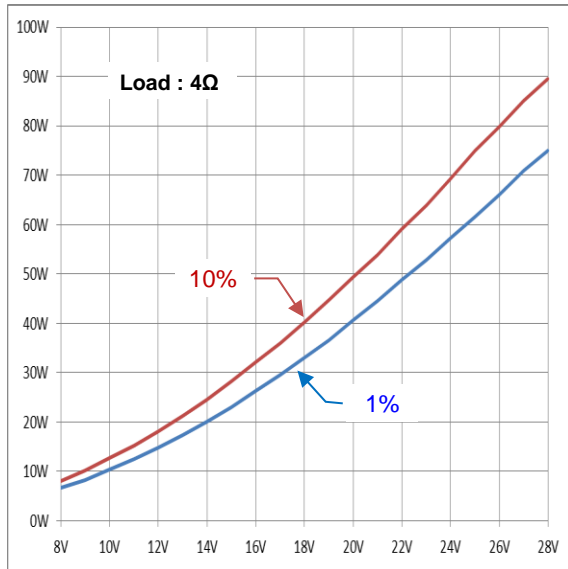

Efficiency vs. Total Power, PBTL DBTL Mode Configuration

Efficiency vs. Output Power

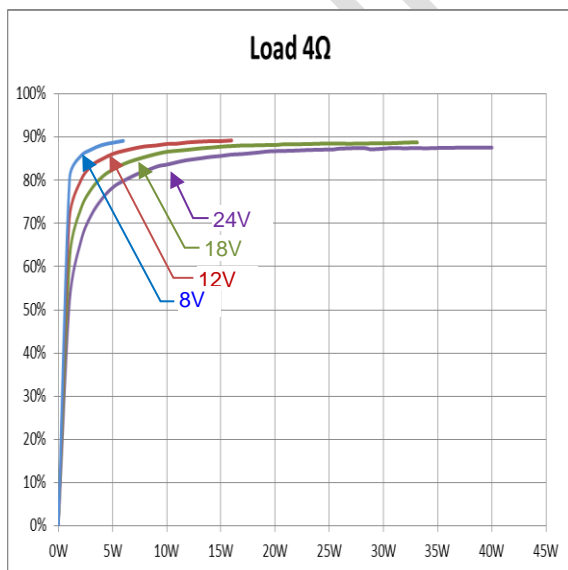

D. Package Outline

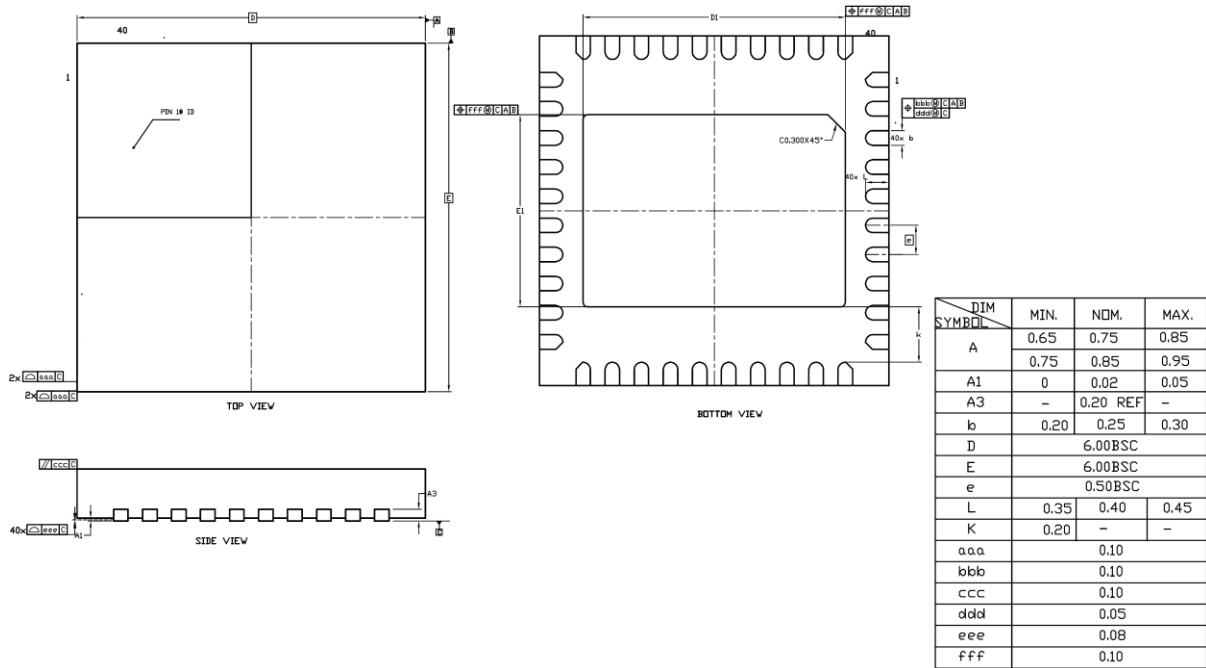

NOTES:

1. DIMENSIONING AND TOLERANCING CONFIRM TO ASME Y14.5M-1994
2. ALL DIMENSIONS ARE IN MILLIMETERS, ANGLES ARE IN DEGREE.
3. UNILATERAL COPLANARITY ZONE APPLIES TO THE EXPOSED HEAT SINK SLUG AS WELL AS THE TERMINALS.
4. DIMENSION b APPLIES TO METALLIZED TERMINAL AND IS MEASURED BETWEEN 0.150mm TO 0.30mm FROM THE TERMINAL TIP. DIMENSION b SHOULD NOT BE MEASURED IN RADIUS AREA..
5. ALL SPEC TAKE JEDEC MO-220 FOR REFERENCE.