

NTP8G206N

Power GaN Cascode Transistor 600 V, 150 mΩ

Features

- Fast Switching
- Extremely Low Q_{rr}
- Transphorm Inside
- These Devices are Pb-Free, Halogen Free/BFR Free and are RoHS Compliant

ABSOLUTE MAXIMUM RATINGS ($T_J = 25^\circ\text{C}$ unless otherwise noted)

Parameter	Symbol	NDD	Unit
Drain-to-Source Voltage	V_{DSS}	600	V
Gate-to-Source Voltage	V_{GS}	± 18	V
Continuous Drain Current $R_{\theta JC}$	Steady State	$T_C = 25^\circ\text{C}$	17
		$T_C = 100^\circ\text{C}$	12
Power Dissipation – $R_{\theta JC}$	Steady State	$T_C = 25^\circ\text{C}$	96
Pulsed Drain Current	$t_p = 10 \mu\text{s}$	I_{DM}	60
Operating Junction and Storage Temperature	T_J, T_{STG}	-55 to +150	$^\circ\text{C}$
Lead Temperature for Soldering Leads	T_L	260	$^\circ\text{C}$

Stresses exceeding those listed in the Maximum Ratings table may damage the device. If any of these limits are exceeded, device functionality should not be assumed, damage may occur and reliability may be affected.

THERMAL RESISTANCE

Parameter	Symbol	Value	Unit
Junction-to-Case (Drain)	$R_{\theta JC}$	1.55	$^\circ\text{C}/\text{W}$
Junction-to-Ambient Steady State	$R_{\theta JA}$	62	$^\circ\text{C}/\text{W}$



ON Semiconductor®

www.onsemi.com

$V_{(BR)DSS}$	$R_{DS(ON)}$ TYP
600 V	150 mΩ @ 10 V

N-Channel MOSFET

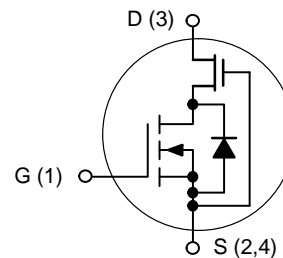

MARKING DIAGRAM & PIN ASSIGNMENT

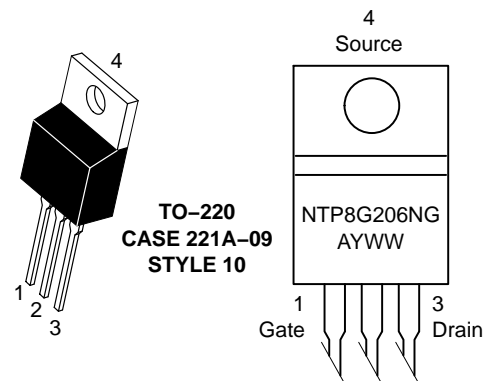

- A = Assembly Location
- Y = Year
- WW = Work Week
- G = Pb-Free Package

ORDERING INFORMATION

Device	Package	Shipping
NTP8G206NG	TO-220 (Pb-Free)	50 Units / Rail

NTP8G206N

ELECTRICAL CHARACTERISTICS (T_J = 25°C unless otherwise noted)

Characteristic	Symbol	Test Conditions	Min	Typ	Max	Unit
----------------	--------	-----------------	-----	-----	-----	------

OFF CHARACTERISTICS

Drain-to-Source Breakdown Voltage	V _{(BR)DSS}	V _{GS} = 0 V, I _D = 1 mA	600			V
Drain-to-Source Leakage Current	I _{DSS}	V _{DS} = 600 V, V _{GS} = 0 V	T _J = 25°C	2.5	90	μA
			T _J = 150°C	8.0		
Gate-to-Source Leakage Current	I _{GSS}	V _{GS} = ±18 V			±100	nA

ON CHARACTERISTICS (Note 1)

Gate Threshold Voltage	V _{GS(TH)}	V _{DS} = V _{GS} , I _D = 500 μA	1.6	2.1	2.6	V
Static Drain-to-Source On Resistance	R _{DS(on)}	V _{GS} = 8 V, I _D = 11 A, T _J = 25°C		150	180	mΩ
		V _{GS} = 8 V, I _D = 11 A, T _J = 175°C		340		

DYNAMIC CHARACTERISTICS

Input Capacitance	C _{iss}	V _{DS} = 480 V, V _{GS} = 0 V, f = 1 MHz		760		pF
Output Capacitance	C _{oss}			44		
Reverse Transfer Capacitance	C _{rss}			5.0		
Effective output capacitance, energy related (Note 3)	C _{o(er)}	V _{GS} = 0 V, V _{DS} = 0 to 480 V		64		nF
Effective output capacitance, time related (Note 4)	C _{o(tr)}	I _D = constant, V _{GS} = 0 V, V _{DS} = 0 to 480 V		105		
Total Gate Charge	Q _g	V _{DS} = 100 V, I _D = 11 A, V _{GS} = 4.5 V		6.2	9.3	
Gate-to-Source Charge	Q _{gs}			2.1		
Gate-to-Drain Charge	Q _{gd}			2.2		

SWITCHING CHARACTERISTICS (Note 2)

Turn-on Delay Time	t _{d(on)}	V _{DD} = 480 V, I _D = 11 A, V _{GS} = 10 V, R _G = 2 Ω		6.2		ns
Rise Time	t _r			4.5		
Turn-off Delay Time	t _{d(off)}			9.7		
Fall Time	t _f			4.0		

SOURCE-DRAIN DIODE CHARACTERISTICS

Diode Forward Voltage	V _{SD}	I _S = 11 A, V _{GS} = 0 V	T _J = 25°C		2.2		V
Reverse Recovery Time	t _{rr}	V _{GS} = 0 V, V _{DD} = 400 V, I _S = 11 A, d _i /d _t = 2000 A/μs			17		ns
Reverse Recovery Charge	Q _{rr}					53	

Product parametric performance is indicated in the Electrical Characteristics for the listed test conditions, unless otherwise noted. Product performance may not be indicated by the Electrical Characteristics if operated under different conditions.

1. Pulse Width ≤ 300 μs, Duty Cycle ≤ 2%.
2. Switching characteristics are independent of operating junction temperatures.
3. C_{o(er)} is a fixed capacitance that gives the same stored energy as C_{oss} while V_{DS} is rising from 0 to 80% V_{(BR)DSS}
4. C_{o(tr)} is a fixed capacitance that gives the same charging time as C_{oss} while V_{DS} is rising from 0 to 80% V_{(BR)DSS}

NTP8G206N

TYPICAL CHARACTERISTICS

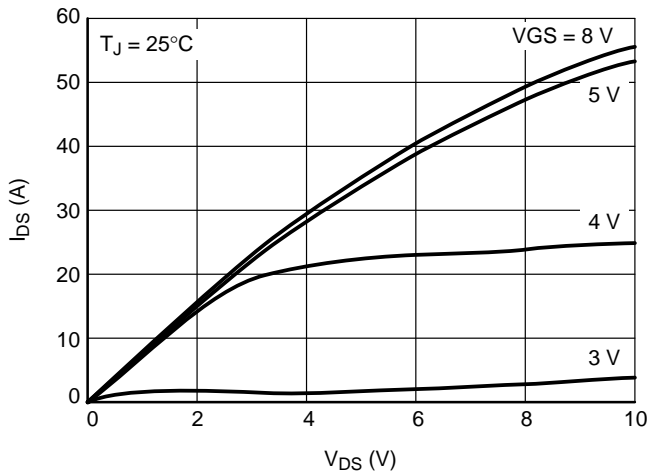

Figure 1. Typical Output Characteristics

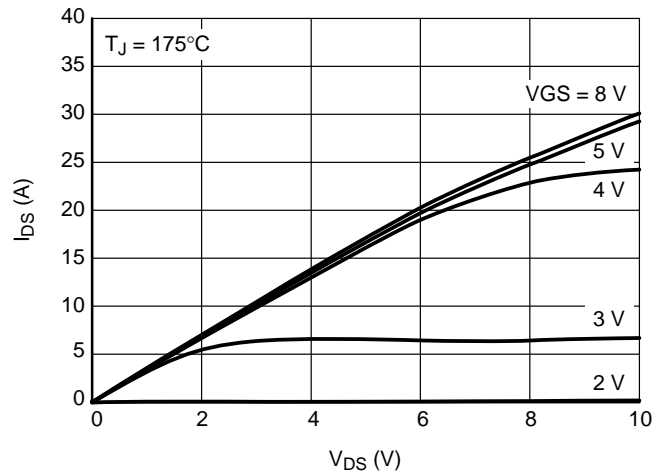

Figure 2. Typical Output Characteristics

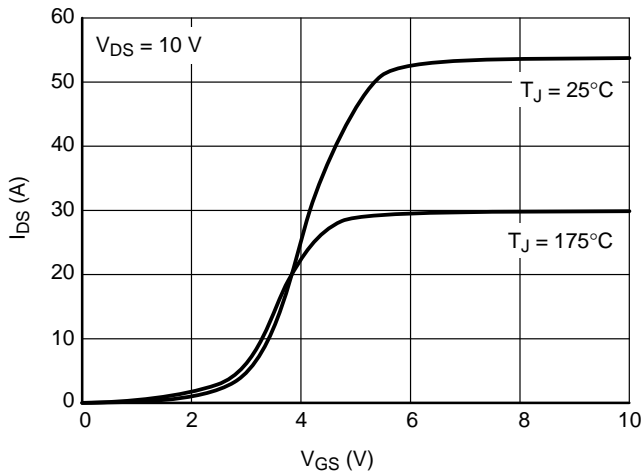

Figure 3. Typical Transfer Characteristics

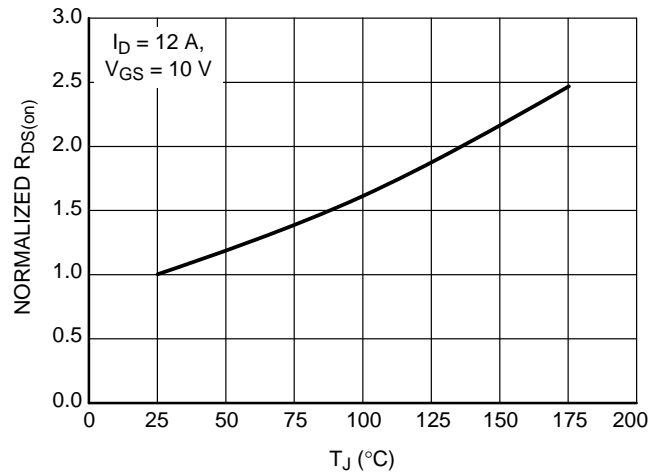

Figure 4. Normalized On-Resistance

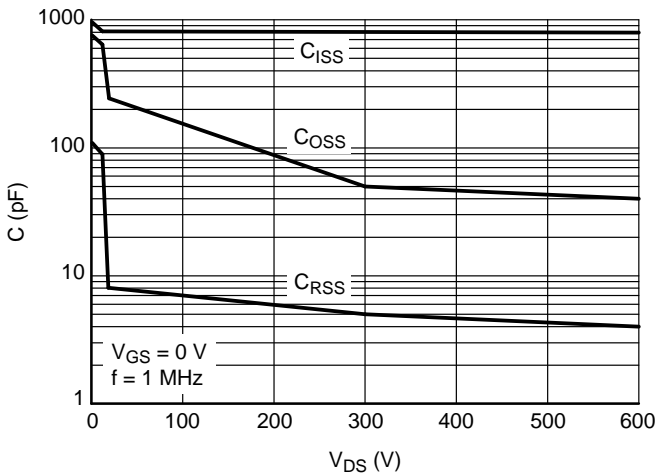

Figure 5. Typical Capacitance

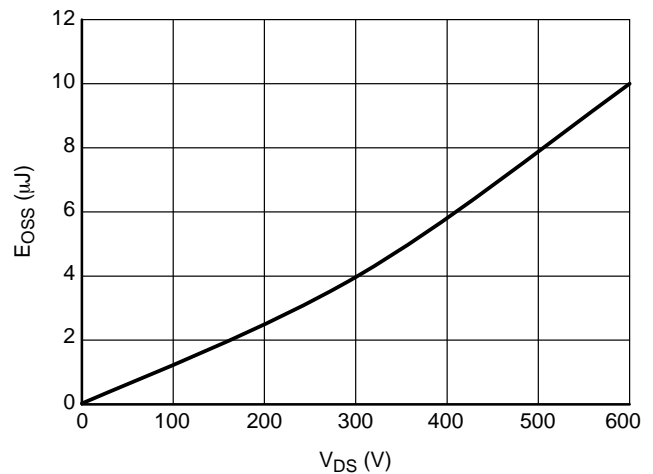

Figure 6. Typical Coss Stored Energy

NTP8G206N

TYPICAL CHARACTERISTICS

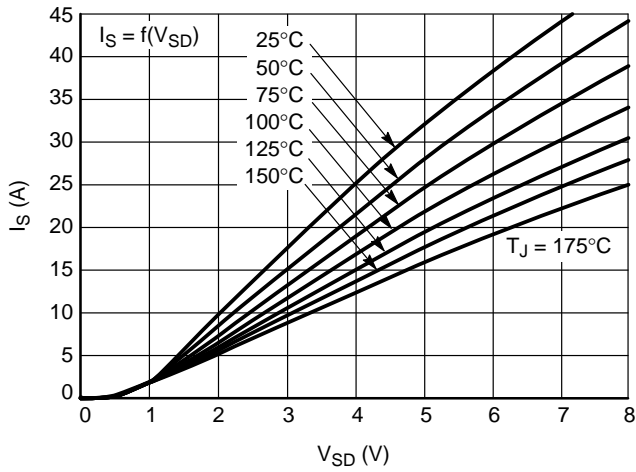

Figure 7. Forward Characteristics of Rev. Diode

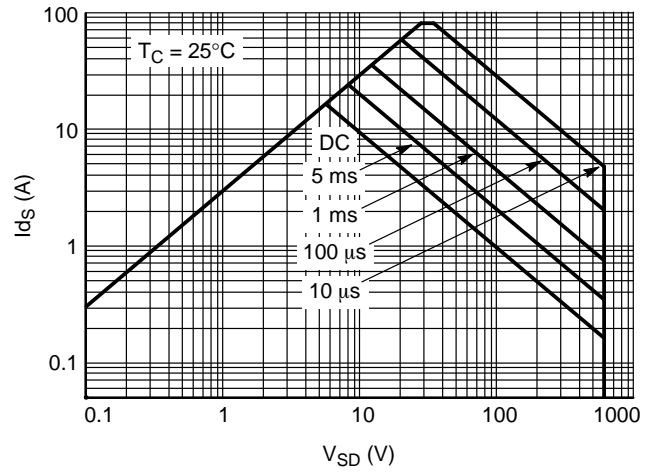

Figure 8. Safe Operating Area

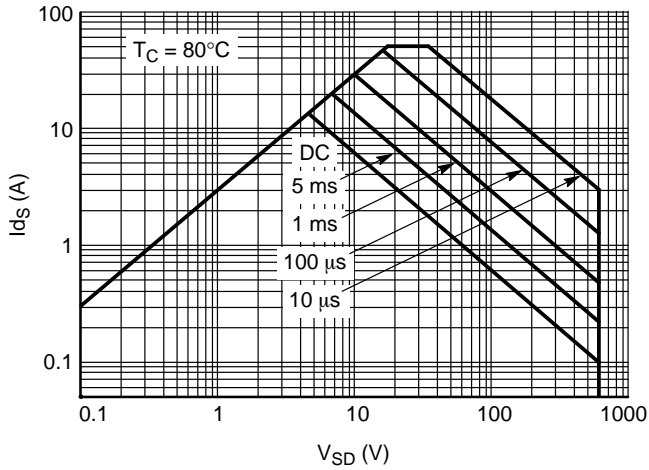

Figure 9. Safe Operating Area

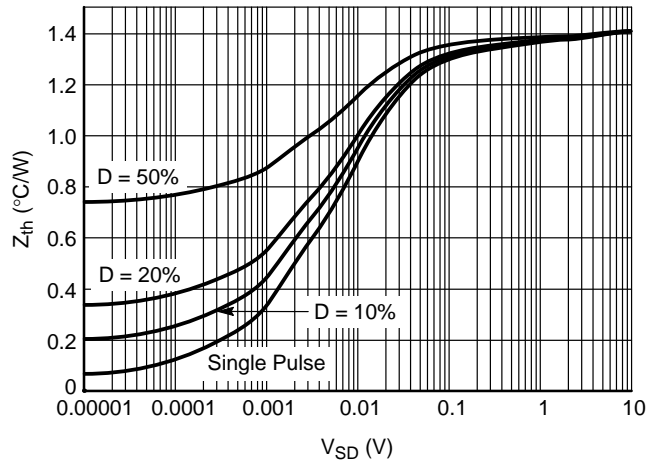

Figure 10. Transient Thermal Resistance

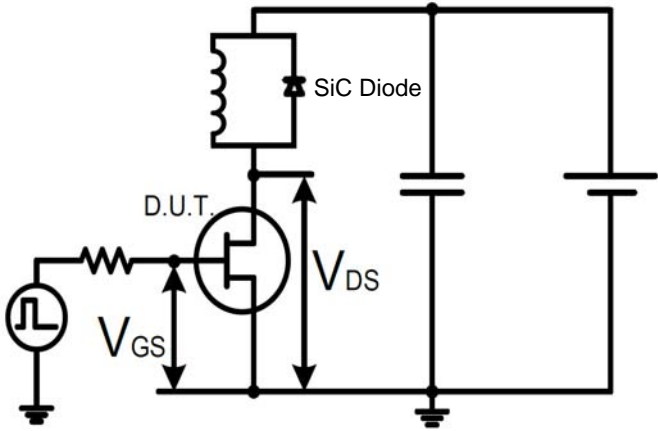

Figure 11. Switching Time Test Circuit

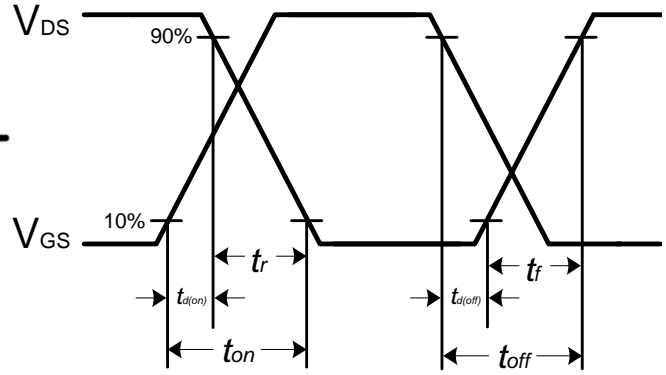

Figure 12. Switching Time Waveform

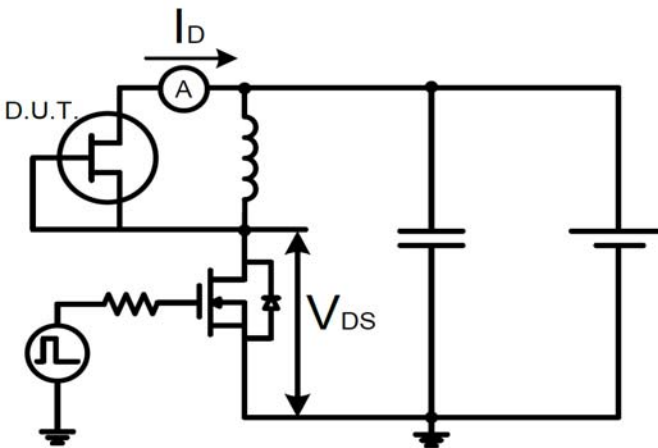

Figure 13. Test Circuit for Reverse Diode Characteristics

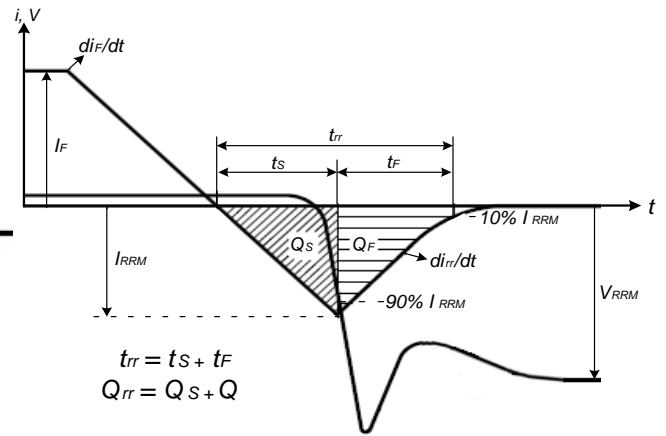
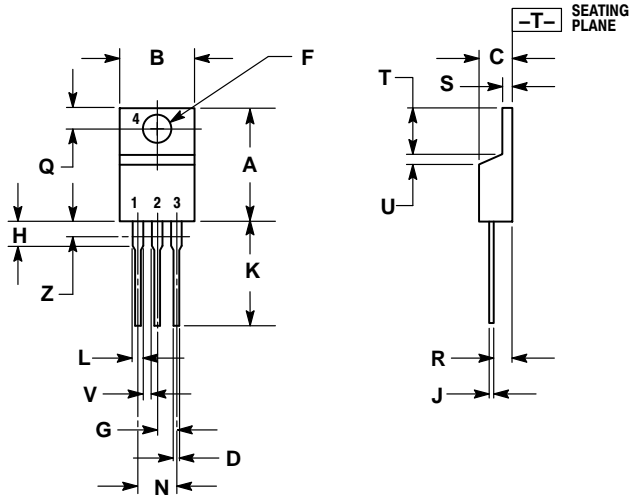

Figure 14. Diode Recovery Waveform

NTP8G206N

PACKAGE DIMENSIONS

TO-220
CASE 221A-09
ISSUE AH



NOTES:

1. DIMENSIONING AND TOLERANCING PER ANSI Y14.5M, 1982.
2. CONTROLLING DIMENSION: INCH.
3. DIMENSION Z DEFINES A ZONE WHERE ALL BODY AND LEAD IRREGULARITIES ARE ALLOWED.

DIM	INCHES		MILLIMETERS	
	MIN	MAX	MIN	MAX
A	0.570	0.620	14.48	15.75
B	0.380	0.415	9.66	10.53
C	0.160	0.190	4.07	4.83
D	0.025	0.038	0.64	0.96
F	0.142	0.161	3.61	4.09
G	0.095	0.105	2.42	2.66
H	0.110	0.161	2.80	4.10
J	0.014	0.024	0.36	0.61
K	0.500	0.562	12.70	14.27
L	0.045	0.060	1.15	1.52
N	0.190	0.210	4.83	5.33
Q	0.100	0.120	2.54	3.04
R	0.080	0.110	2.04	2.79
S	0.045	0.055	1.15	1.39
T	0.235	0.255	5.97	6.47
U	0.000	0.050	0.00	1.27
V	0.045	---	1.15	---
Z	---	0.080	---	2.04

STYLE 10:

- PIN 1. GATE
- SOURCE
- DRAIN
- SOURCE

ON Semiconductor and the  are registered trademarks of Semiconductor Components Industries, LLC (SCILLC) or its subsidiaries in the United States and/or other countries. SCILLC owns the rights to a number of patents, trademarks, copyrights, trade secrets, and other intellectual property. A listing of SCILLC's product/patent coverage may be accessed at www.onsemi.com/site/pdf/Patent-Marking.pdf. SCILLC reserves the right to make changes without further notice to any products herein. SCILLC makes no warranty, representation or guarantee regarding the suitability of its products for any particular purpose, nor does SCILLC assume any liability arising out of the application or use of any product or circuit, and specifically disclaims any and all liability, including without limitation special, consequential or incidental damages. "Typical" parameters which may be provided in SCILLC data sheets and/or specifications can and do vary in different applications and actual performance may vary over time. All operating parameters, including "Typicals" must be validated for each customer application by customer's technical experts. SCILLC does not convey any license under its patent rights nor the rights of others. SCILLC products are not designed, intended, or authorized for use as components in systems intended for surgical implant into the body, or other applications intended to support or sustain life, or for any other application in which the failure of the SCILLC product could create a situation where personal injury or death may occur. Should Buyer purchase or use SCILLC products for any such unintended or unauthorized application, Buyer shall indemnify and hold SCILLC and its officers, employees, subsidiaries, affiliates, and distributors harmless against all claims, costs, damages, and expenses, and reasonable attorney fees arising out of, directly or indirectly, any claim of personal injury or death associated with such unintended or unauthorized use, even if such claim alleges that SCILLC was negligent regarding the design or manufacture of the part. SCILLC is an Equal Opportunity/Affirmative Action Employer. This literature is subject to all applicable copyright laws and is not for resale in any manner.

PUBLICATION ORDERING INFORMATION

LITERATURE FULFILLMENT:

Literature Distribution Center for ON Semiconductor
P.O. Box 5163, Denver, Colorado 80217 USA
Phone: 303-675-2175 or 800-344-3860 Toll Free USA/Canada
Fax: 303-675-2176 or 800-344-3867 Toll Free USA/Canada
Email: orderlit@onsemi.com

N. American Technical Support: 800-282-9855 Toll Free
USA/Canada
Europe, Middle East and Africa Technical Support:
Phone: 421 33 790 2910
Japan Customer Focus Center
Phone: 81-3-5817-1050

ON Semiconductor Website: www.onsemi.com

Order Literature: <http://www.onsemi.com/orderlit>

For additional information, please contact your local Sales Representative

NTP8G206N/D