

NTR1P02, NVR1P02

Power MOSFET

-20 V, -1 A, P-Channel SOT-23 Package



ON Semiconductor®

<http://onsemi.com>

Features

- Ultra Low On-Resistance Provides Higher Efficiency and Extends Battery Life
 $R_{DS(on)} = 0.180 \Omega$, $V_{GS} = -10 \text{ V}$
 $R_{DS(on)} = 0.280 \Omega$, $V_{GS} = -4.5 \text{ V}$
- Power Management in Portable and Battery-Powered Products
- Miniature SOT-23 Surface Mount Package Saves Board Space
- Mounting Information for SOT-23 Package Provided
- NVR Prefix for Automotive and Other Applications Requiring Unique Site and Control Change Requirements; AEC-Q101 Qualified and PPAP Capable*
- These Devices are Pb-Free and are RoHS Compliant

Applications

- DC-DC Converters
- Computers
- Printers
- PCMCIA Cards
- Cellular and Cordless Telephones

MAXIMUM RATINGS ($T_J = 25^\circ\text{C}$ unless otherwise noted)

Rating	Symbol	Value	Unit
Drain-to-Source Voltage	V_{DSS}	-20	V
Gate-to-Source Voltage - Continuous	V_{GS}	± 20	V
Drain Current	I_D	-1.0	A
- Continuous @ $T_A = 25^\circ\text{C}$	I_{DM}	-2.67	
- Pulsed Drain Current ($t_p \leq 1 \mu\text{s}$)			
Total Power Dissipation @ $T_A = 25^\circ\text{C}$	P_D	400	mW
Operating and Storage Temperature Range	T_J, T_{stg}	-55 to 150	$^\circ\text{C}$
Thermal Resistance; Junction-to-Ambient	$R_{\theta JA}$	300	$^\circ\text{C}/\text{W}$
Maximum Lead Temperature for Soldering Purposes, (1/8" from case for 10 s)	T_L	260	$^\circ\text{C}$

Stresses exceeding Maximum Ratings may damage the device. Maximum Ratings are stress ratings only. Functional operation above the Recommended Operating Conditions is not implied. Extended exposure to stresses above the Recommended Operating Conditions may affect device reliability.

$V_{(BR)DSS}$	$R_{DS(on)}$ TYP	I_D MAX
-20 V	148 m Ω @ -10 V	-1.0 A

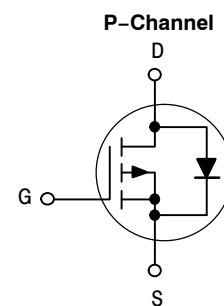

MARKING DIAGRAM/ PIN ASSIGNMENT

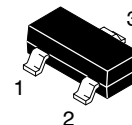

SOT-23
CASE 318
STYLE 21

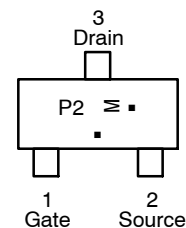

P2 = Specific Device Code
M = Date Code
▪ = Pb-Free Package
(Note: Microdot may be in either location)

ORDERING INFORMATION

Device	Package	Shipping†
NTR1P02T1G	SOT-23 (Pb-Free)	3000 / Tape & Reel
NTR1P02T3G	SOT-23 (Pb-Free)	10000 / Tape & Reel
NVR1P02T1G*	SOT-23 (Pb-Free)	3000 / Tape & Reel

† For information on tape and reel specifications, including part orientation and tape sizes, please refer to our Tape and Reel Packaging Specification Brochure, BRD8011/D.

NTR1P02, NVR1P02

ELECTRICAL CHARACTERISTICS ($T_A = 25^\circ\text{C}$ unless otherwise noted)

Characteristic	Symbol	Min	Typ	Max	Unit
OFF CHARACTERISTICS					
Drain-to-Source Breakdown Voltage ($V_{GS} = 0\text{ V}$, $I_D = -10\ \mu\text{A}$) (Positive Temperature Coefficient)	$V_{(BR)DSS}$	-20	32		V mV/ $^\circ\text{C}$
Zero Gate Voltage Drain Current ($V_{DS} = -20\text{ V}$, $V_{GS} = 0\text{ V}$, $T_J = 25^\circ\text{C}$) ($V_{DS} = -20\text{ V}$, $V_{GS} = 0\text{ V}$, $T_J = 150^\circ\text{C}$)	I_{DSS}			-1.0 -10	μA
Gate-Body Leakage Current ($V_{GS} = \pm 20\text{ V}$, $V_{DS} = 0\text{ V}$)	I_{GSS}			± 100	nA

ON CHARACTERISTICS (Note 1)

Gate Threshold Voltage ($V_{DS} = V_{GS}$, $I_D = -250\ \mu\text{A}$) (Negative Temperature Coefficient)	$V_{GS(th)}$	-1.1	-1.9 -4.0	-2.3	V mV/ $^\circ\text{C}$
Static Drain-to-Source On-State Resistance ($V_{GS} = -10\text{ V}$, $I_D = -1.5\text{ A}$) ($V_{GS} = -4.5\text{ V}$, $I_D = -0.75\text{ A}$)	$R_{DS(on)}$		0.148 0.235	0.180 0.280	Ω

DYNAMIC CHARACTERISTICS

Input Capacitance ($V_{DS} = -5\text{ V}$, $V_{GS} = 0\text{ V}$, $f = 1.0\text{ MHz}$)	C_{iss}		165		pF
Output Capacitance ($V_{DS} = -5\text{ V}$, $V_{GS} = 0\text{ V}$, $f = 1.0\text{ MHz}$)	C_{oss}		110		
Reverse Transfer Capacitance ($V_{DS} = -5\text{ V}$, $V_{GS} = 0\text{ V}$, $f = 1.0\text{ MHz}$)	C_{rss}		35		

SWITCHING CHARACTERISTICS (Note 2)

Turn-On Delay Time ($V_{DD} = -15\text{ V}$, $I_D = -1\text{ A}$, $V_{GS} = -5\text{ V}$, $R_G = 2.5\ \Omega$)	$t_{d(on)}$		7.0		ns
Rise Time ($V_{DD} = -15\text{ V}$, $I_D = -1\text{ A}$, $V_{GS} = -5\text{ V}$, $R_G = 2.5\ \Omega$)	t_r		9.0		
Turn-Off Delay Time ($V_{DD} = -15\text{ V}$, $I_D = -1\text{ A}$, $V_{GS} = -5\text{ V}$, $R_G = 2.5\ \Omega$)	$t_{d(off)}$		9.0		
Fall Time ($V_{DD} = -15\text{ V}$, $I_D = -1\text{ A}$, $V_{GS} = -5\text{ V}$, $R_G = 2.5\ \Omega$)	t_f		3.0		
Total Gate Charge ($V_{DS} = -15\text{ V}$, $V_{GS} = -5\text{ V}$, $I_D = -0.8\text{ A}$)	Q_{tot}		2.5		nC
Gate-Source Charge ($V_{DS} = -15\text{ V}$, $V_{GS} = -5\text{ V}$, $I_D = -0.8\text{ A}$)	Q_{gs}		0.75		
Gate-Drain Charge ($V_{DS} = -15\text{ V}$, $V_{GS} = -5\text{ V}$, $I_D = -0.8\text{ A}$)	Q_{gd}		1.0		

BODY-DRAIN DIODE RATINGS (Note 1)

Diode Forward On-Voltage (Note 2) ($I_S = -0.6\text{ A}$, $V_{GS} = 0\text{ V}$) ($I_S = -0.6\text{ A}$, $V_{GS} = 0\text{ V}$, $T_J = 150^\circ\text{C}$)	V_{SD}		-0.8 -0.6	-1.0	V
Reverse Recovery Time ($I_S = -1\text{ A}$, $di_S/dt = 100\text{ A}/\mu\text{s}$, $V_{GS} = 0\text{ V}$)	t_{rr}		13.5		ns
	t_a		10.5		
	t_b		3.0		
Reverse Recovery Stored Charge ($I_S = -1\text{ A}$, $di_S/dt = 100\text{ A}/\mu\text{s}$, $V_{GS} = 0\text{ V}$)	Q_{RR}		0.008		μC

1. Pulse Test: Pulse Width $\leq 300\ \mu\text{s}$, Duty Cycle $\leq 2\%$.
2. Switching characteristics are independent of operating junction temperature.

NTR1P02, NVR1P02

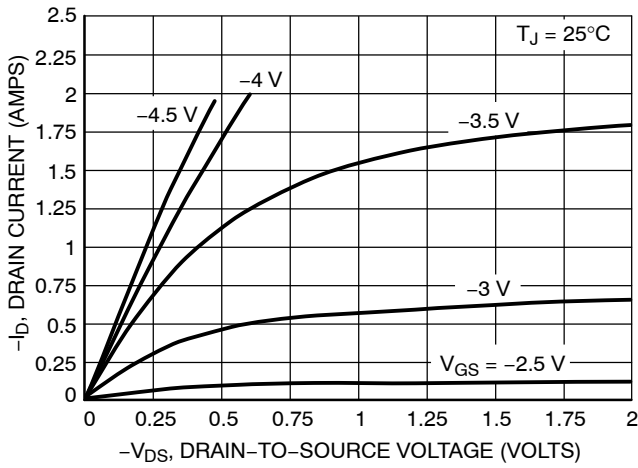

Figure 1. On-Region Characteristics

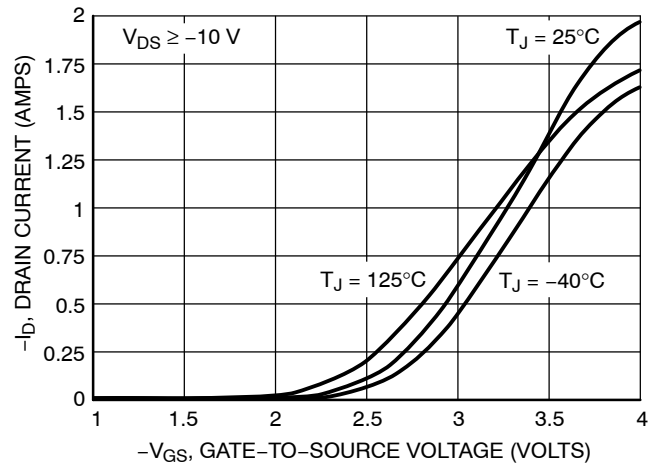

Figure 2. Transfer Characteristics

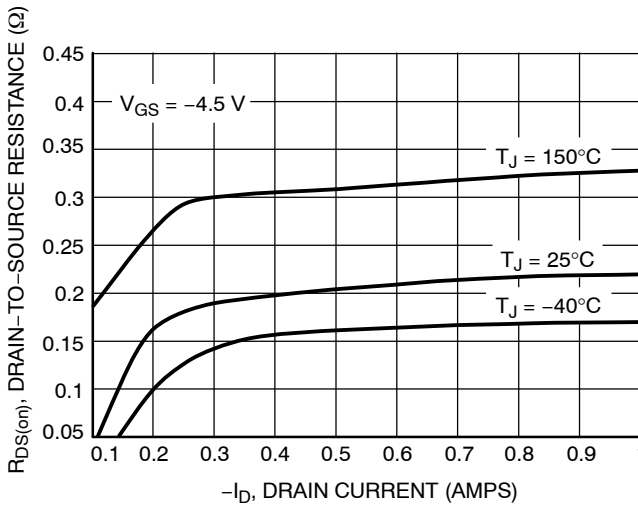

Figure 3. On-Resistance versus Drain Current and Temperature

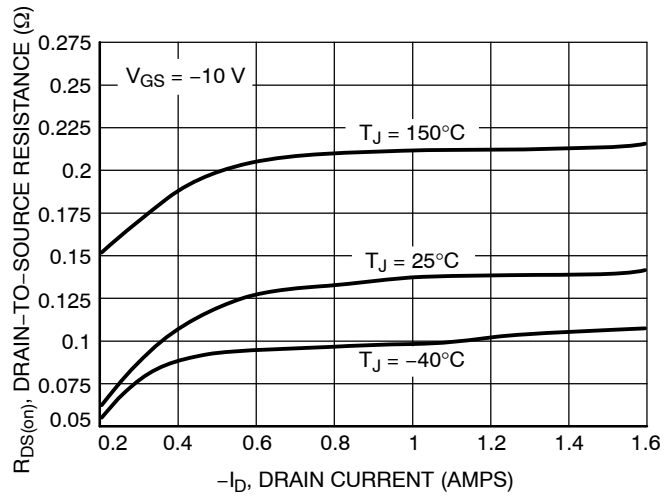

Figure 4. On-Resistance versus Drain Current and Temperature

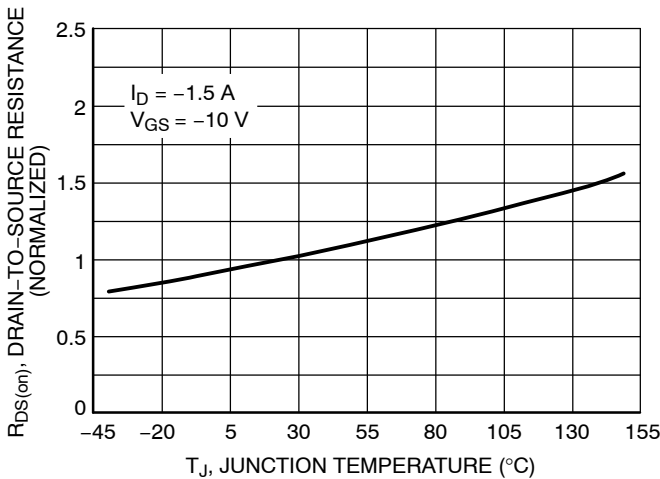

Figure 5. On-Resistance Variation with Temperature

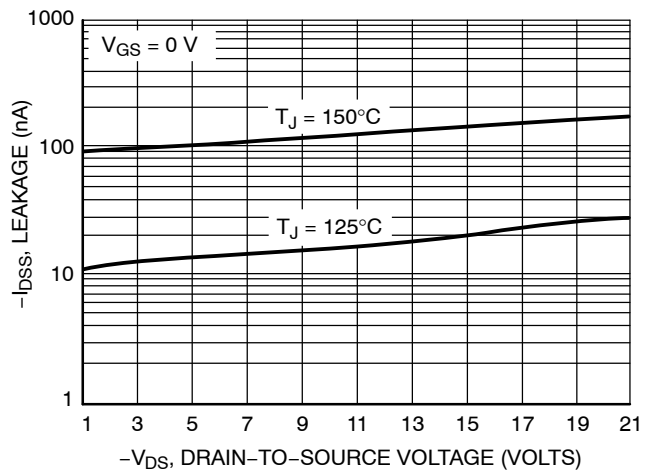

Figure 6. Drain-to-Source Leakage Current versus Voltage

NTR1P02, NVR1P02

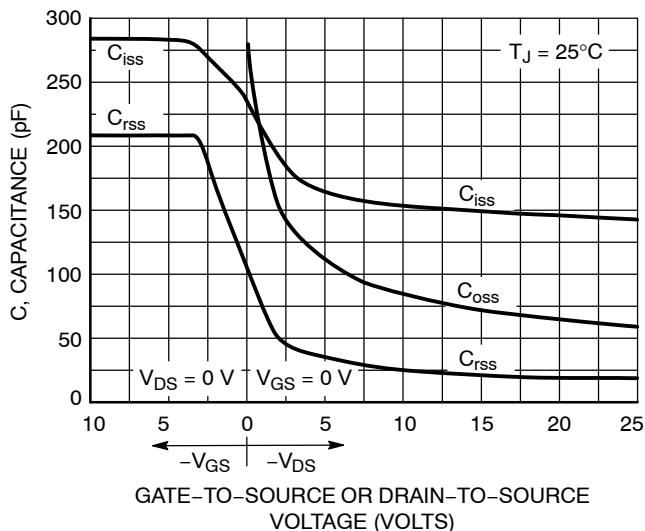

Figure 7. Capacitance Variation

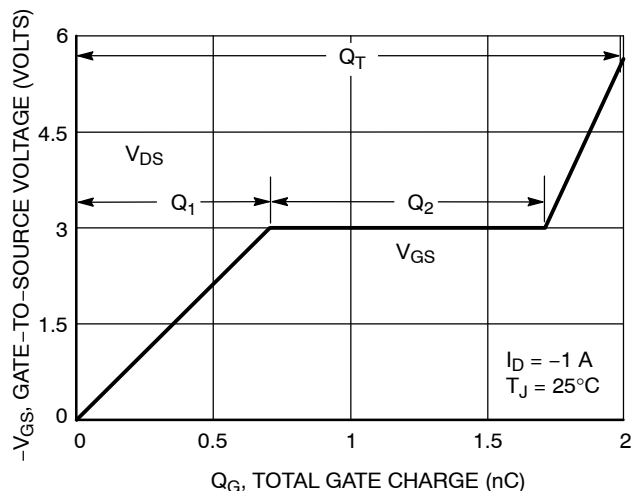

Figure 8. Gate-to-Source and Drain-to-Source Voltage versus Total Charge

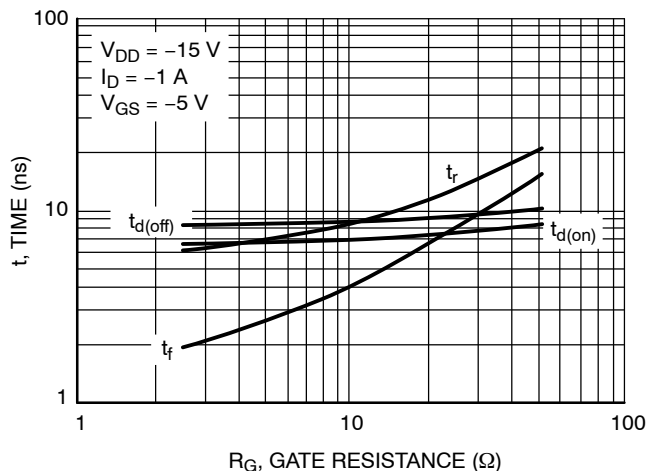

Figure 9. Resistive Switching Time Variation versus Gate Resistance

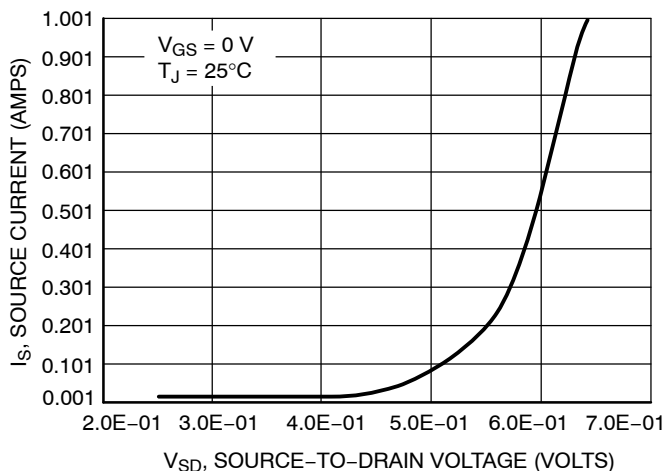
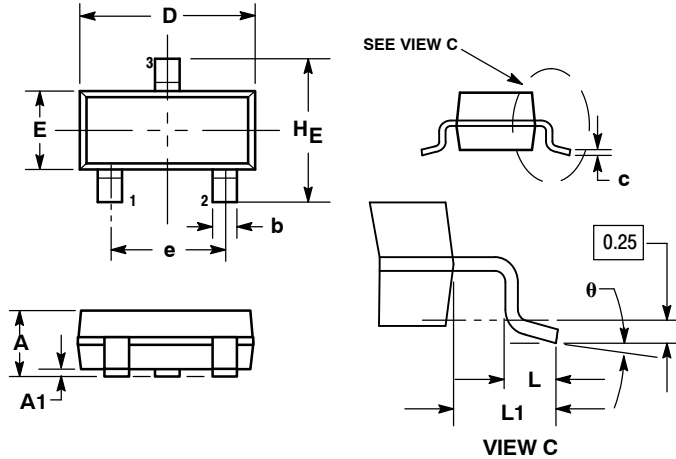

Figure 10. Diode Forward Voltage versus Current

NTR1P02, NVR1P02

PACKAGE DIMENSIONS

SOT-23 (TO-236)
CASE 318-08
ISSUE AP



NOTES:

1. DIMENSIONING AND TOLERANCING PER ANSI Y14.5M, 1982.
2. CONTROLLING DIMENSION: INCH.
3. MAXIMUM LEAD THICKNESS INCLUDES LEAD FINISH THICKNESS. MINIMUM LEAD THICKNESS IS THE MINIMUM THICKNESS OF BASE MATERIAL.
4. DIMENSIONS D AND E DO NOT INCLUDE MOLD FLASH, PROTRUSIONS, OR GATE BURRS.

DIM	MILLIMETERS			INCHES		
	MIN	NOM	MAX	MIN	NOM	MAX
A	0.89	1.00	1.11	0.035	0.040	0.044
A1	0.01	0.06	0.10	0.001	0.002	0.004
b	0.37	0.44	0.50	0.015	0.018	0.020
c	0.09	0.13	0.18	0.003	0.005	0.007
D	2.80	2.90	3.04	0.110	0.114	0.120
E	1.20	1.30	1.40	0.047	0.051	0.055
e	1.78	1.90	2.04	0.070	0.075	0.081
L	0.10	0.20	0.30	0.004	0.008	0.012
L1	0.35	0.54	0.69	0.014	0.021	0.029
HE	2.10	2.40	2.64	0.083	0.094	0.104
θ	0°	---	10°	0°	---	10°

STYLE 21:

1. GATE
2. SOURCE
3. DRAIN

SOLDERING FOOTPRINT*

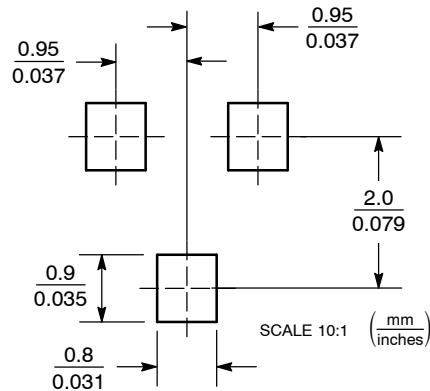

*For additional information on our Pb-Free strategy and soldering details, please download the ON Semiconductor Soldering and Mounting Techniques Reference Manual, SOLDERRM/D.

ON Semiconductor and  are registered trademarks of Semiconductor Components Industries, LLC (SCILLC). SCILLC reserves the right to make changes without further notice to any products herein. SCILLC makes no warranty, representation or guarantee regarding the suitability of its products for any particular purpose, nor does SCILLC assume any liability arising out of the application or use of any product or circuit, and specifically disclaims any and all liability, including without limitation special, consequential or incidental damages. "Typical" parameters which may be provided in SCILLC data sheets and/or specifications can and do vary in different applications and actual performance may vary over time. All operating parameters, including "Typicals" must be validated for each customer application by customer's technical experts. SCILLC does not convey any license under its patent rights nor the rights of others. SCILLC products are not designed, intended, or authorized for use as components in systems intended for surgical implant into the body, or other applications intended to support or sustain life, or for any other application in which the failure of the SCILLC product could create a situation where personal injury or death may occur. Should Buyer purchase or use SCILLC products for any such unintended or unauthorized application, Buyer shall indemnify and hold SCILLC and its officers, employees, subsidiaries, affiliates, and distributors harmless against all claims, costs, damages, and expenses, and reasonable attorney fees arising out of, directly or indirectly, any claim of personal injury or death associated with such unintended or unauthorized use, even if such claim alleges that SCILLC was negligent regarding the design or manufacture of the part. SCILLC is an Equal Opportunity/Affirmative Action Employer. This literature is subject to all applicable copyright laws and is not for resale in any manner.

PUBLICATION ORDERING INFORMATION

LITERATURE FULFILLMENT:
Literature Distribution Center for ON Semiconductor
P.O. Box 5163, Denver, Colorado 80217 USA
Phone: 303-675-2175 or 800-344-3860 Toll Free USA/Canada
Fax: 303-675-2176 or 800-344-3867 Toll Free USA/Canada
Email: orderlit@onsemi.com

N. American Technical Support: 800-282-9855 Toll Free
USA/Canada
Europe, Middle East and Africa Technical Support:
Phone: 421 33 790 2910
Japan Customer Focus Center
Phone: 81-3-5817-1050

ON Semiconductor Website: www.onsemi.com
Order Literature: <http://www.onsemi.com/orderlit>

For additional information, please contact your local Sales Representative