

Panasonic

Video Cassette Recorder

NV-HS820 Series

Operating Instructions
Bedienungsanleitung

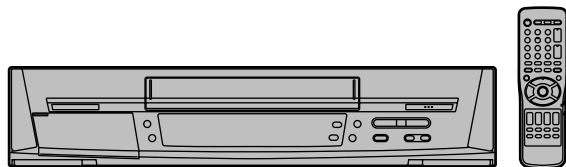

Contents	Page
----------	------

Warning and Important Information	2
Controls and Components	3
VCR Operation	4
Menu Operation	4
TV Operation	4
Connecting and Setting up	5
Playback	9
Recording	10
Satellite or Digital Receiver	13
Timer Recording	14
Search Functions	16
Editing	16
Connecting a Decoder	17
Connecting a Stereo Amplifier	17
Manual Tuning	18
Setting the VCR's Clock	20
Various Settings	20
Other Function	22
Before Requesting Service	23
Index	25
Specifications	26

SHOWVIEW



SUPER DRIVE

S-VHSET

Warning and Important Information

As this equipment gets hot during use, operate it in a well ventilated place; do not install this equipment in a confined space such as a book case or similar unit.

Important

Your attention is drawn to the fact that the recording of pre-recorded tapes or discs or other published or broadcast material may infringe copyright laws.

Warning

To reduce the risk of fire or shock hazard, do not expose this equipment to rain or moisture.

For your safety

Do not remove outer cover.

Touching internal parts of the VCR is dangerous, and may seriously damage it.

To prevent electric shock, do not remove cover. There are no user serviceable parts inside. Refer all servicing to qualified service personnel.

Inserting Remote Control Batteries

Insert the batteries with the polarity (\oplus and \ominus) correctly aligned.

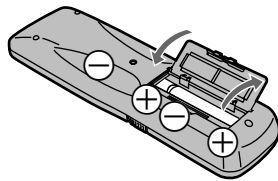

Notes:

- The service life of the batteries is approximately 1 year. However, it varies considerably depending on the frequency of use.
- When they are exhausted, replace them with two AA, UM3, or R6 size batteries.
- When the batteries are exhausted, remove them immediately and dispose of them correctly.
- Make sure that the batteries are inserted with the polarity (\oplus and \ominus) correctly aligned.
- Do not mix old battery with new battery.
- Do not mix different battery types, i.e. Alkaline and Manganese.
- Do not use rechargeable (Ni-Cd) batteries.
- Do not heat or short-circuit the batteries.
- When you do not use the remote control for a long time, take out the batteries and store them in a cool, dry place.

Conserve the environment

See [Power save] of page 21.

Disposal of old equipment

Batteries, packaging and old equipment should not be disposed of as domestic waste, but in accordance with the applicable regulations.



Cautions before you operate this VCR

Avoid:

- Humidity and dust.
- Extreme heat such as direct sunlight.
- Magnets or electromagnetic objects.
- Touching internal parts of the VCR.
- Water or some other liquid.
- Lightning. (Disconnect the aerial plug from the VCR during lightning storms.)
- Anything heavy on the VCR.
- Connecting or handling the equipment with wet hands.
- Using a cell phone near the VCR because doing so may cause noise to adversely affect the picture and sound.

Do:

- Wipe the VCR with a clean and dry cloth.
- Install the VCR in a horizontal position.
- Keep the VCR, TV and other equipment switched off until you have finished all connections.

Condensation may form in the following cases:

- The VCR is brought from cold surroundings into a well-heated room.
- The VCR is suddenly brought from cool surroundings, such as an air-conditioned room or car, to a place which is hot and humid.

Note:

- In any of the above-mentioned conditions, do not operate the VCR for at least 1 hour.
This VCR is not equipped with a dew sensor.

Standard Accessories

- 1 pc. RF Coaxial cable
- 1 pc. Remote Control (N2QAKB000001)
- 2 pcs. R6 size batteries
- 1 pc. AC mains lead

Controls and Components

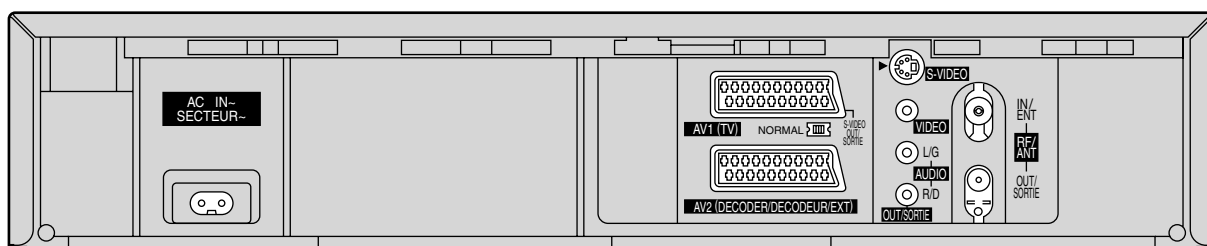
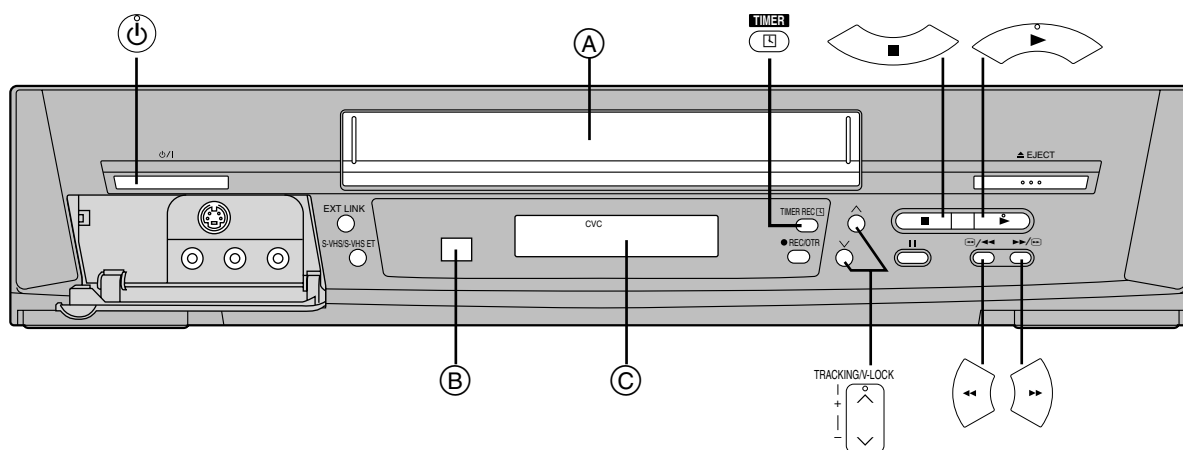

VCR Operation

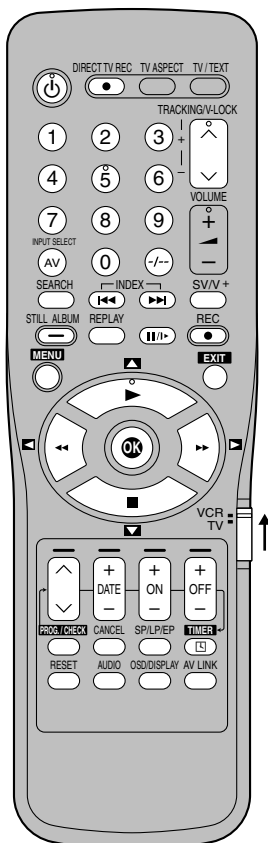

TV Operation

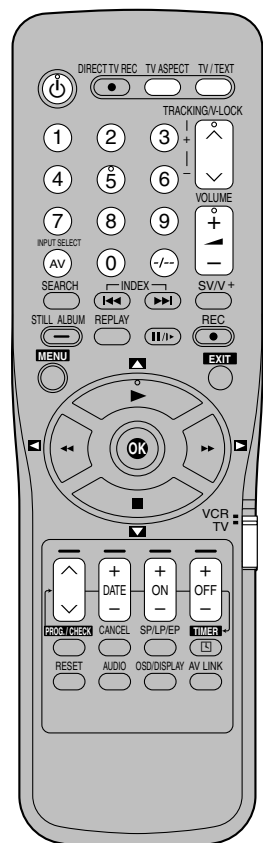

VCR Operation

When you want to operate the VCR, set the [VCR/TV] switch to [VCR].

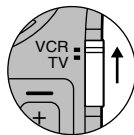

VCR-ON/OFF button



To switch the VCR from on to standby mode or vice versa. In the standby mode, the VCR is still connected to the mains.

Numeric buttons

To select the programme positions (1–99) of the VCR.

Example:

9: 

19:  →  → 

To enter a ShowView number.

To enter numbers for various settings.

RESET button

To reset the tape counter (elapsed time) to [0:00.00].

– The tape counter is automatically reset to [0:00.00] when a video cassette is inserted.

Cassette compartment

Infra-red Remote Control Receiver window

VCR display

Child Lock Function buttons **([OK] and [OFF (+)] buttons)**

This function deactivates all buttons on the VCR and the remote control. Use this function, when you do not want other people to operate the VCR.

To Activate the Child Lock Function

Hold down the [OK] and the [OFF (+)] buttons simultaneously until the [ hold] indication appears in the VCR display.

– If you press a button while the Child Lock function is on, the [ hold] indication appears in the VCR display to inform you that no operation is possible.

To Cancel the Child Lock Function

Hold down the [OK] and the [OFF (+)] buttons simultaneously until the [ hold] indication disappears.

– If you disconnect the mains lead, the Child Lock function is automatically cancelled after the power backup time of approximately 60 minutes has elapsed.

– If you cannot cancel the Child Lock function, press the [EXIT] button and perform the operation.

Menu Operation

Cursor buttons

To select items on the menu.

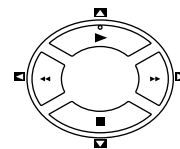

MENU button

To display the Main menu.

EXIT button

To exit the menu.

OK button

To confirm or store the selection.

TV Operation

Only Panasonic TVs can be operated with the provided remote control.

The settings for operating the TV with the remote control have already been made.

However, some Panasonic TVs cannot be operated using this remote control.

When you want to operate the TV, set the [VCR/TV] switch to [TV].

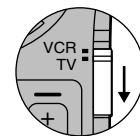

TV-ON/OFF button

To switch the TV on from standby mode or vice versa.

On some TVs it is only possible to switch the TV to standby mode with this button, but not on. In this case, try to turn the TV on with one of the following buttons:

Numeric buttons

AV button

Channel button

Numeric buttons

To select the programme positions (1–99) on the TV.

AV button

To select the desired AV input on the TV.

Channel button

To select the desired programme position (TV station) on the TV.

TV ASPECT button

To switch the screen format between the wide-screen and other formats.

VOLUME button

To adjust the volume of the TV.

TV/TEXT button

To switch between normal TV mode and teletext mode.

Teletext buttons

If your TV is equipped for Teletext reception, you can use these buttons to change the teletext information displayed on the screen and select desired information. For details, refer to your TV's operating instructions.

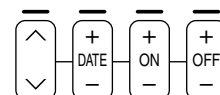

Connecting and Setting up

If you are connecting your VCR to a TV equipped with the [Q Link]*¹ function, then follow the steps.
 For a TV equipped with the [DATA LOGIC]*², [Easy Link]*³, [Megalogic]*⁴ or [SMARTLINK]*⁵ function and with a 21-pin Scart socket, also read from this page.
 For details about the connections, also read TV's operating instructions.

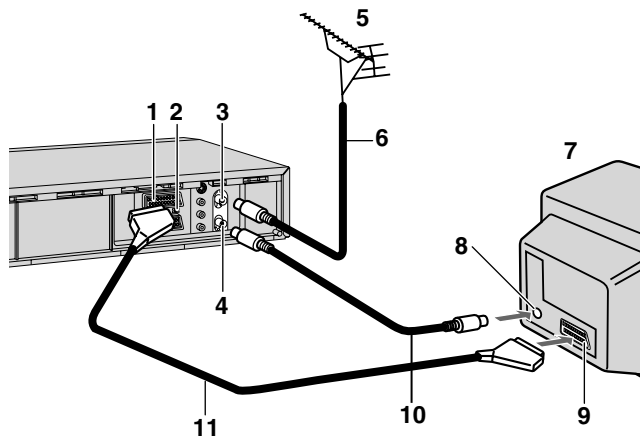

- | | |
|--------------------------------|--|
| 1 AV1 21-pin Scart socket | 7 TV equipped with the Q Link (not supplied) |
| 2 Normal/S-Video Output switch | 8 Aerial Input socket |
| 3 Aerial Input socket | 9 21-pin Scart socket |
| 4 Aerial Output socket | 10 RF Coaxial cable (supplied) |
| 5 Aerial (not supplied) | 11 Fully-wired 21-pin Scart cable (not supplied) |
| 6 Aerial lead (not supplied) | |

Hints:

- Q Link is an advanced system that offers a range of convenient functions such as automatic copying of the tuning position of all available TV stations into your VCR's memory (this is called Download) if you connect the VCR to your TV with a fully-wired 21-pin Scart cable (not supplied). Depending on the manufacturer, the equivalent of the Q Link function has a different name and may not work exactly the same.

- *¹[Q Link] is a registered trademark of Panasonic.
- *²[DATA LOGIC] is a registered trademark of Metz.
- *³[Easy Link] is a registered trademark of Philips.
- *⁴[Megalogic] is a registered trademark of Grundig.
- *⁵[SMARTLINK] is a registered trademark of Sony.

For details, refer to your TV's operating instructions or consult your dealer.

- Unlike in most commercially sold 21-pin Scart cables, in fully-wired 21-pin Scart cables all 21 pins of one plug are connected to the matching pin of the plug on the other end of the cable.
- If the TV set is equipped with a 21-pin Scart socket that features Y/C signal separation, set the [Normal/S-Video Output] switch on the rear panel to [S-VIDEO OUT] so that you can play back with high picture quality and use a fully-wired 21-pin Scart cable (not supplied) to connect the VCR to the TV.

Preset Download (To Simultaneously Set Up this VCR with a New TV)

First of all, make sure that the VCR is switched off.

Switch the TV on.

The TV starts to tune all available TV stations and to adjust the clock.

When the TV has finished its own auto setup, the VCR is automatically switched on, and the downloading of the setup data from the TV to the VCR starts. (Applicable to TVs with [Q Link] or [DATA LOGIC] function)

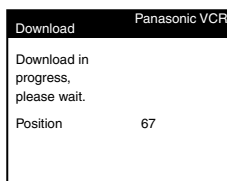

If your TV is equipped with the [Easy Link], [Megalogic] or [SMARTLINK] function, the Country setting menu appears on the TV screen. Press the [Cursor] buttons ▲▼◀▶ to select the desired country and the [OK] button.

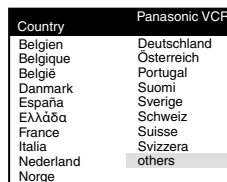

The downloading automatically starts.

When the indication appears on the VCR display, the downloading is complete.



Note:

- If you accidentally switch on the VCR before the TV, downloading of the setup data from the TV may not be performed correctly. In this case, follow the operation steps.

Wait until the Auto Setup is complete on both the TV and the VCR.

- Press the [MENU] button to display the Main menu on the TV screen.

- Press the [Cursor] buttons ▲▼◀▶ to select [Tuning] and then [Download].

- Press the [OK] button twice. Downloading of the setup data from the TV to the VCR starts.

When the programme position and the current time appear in the VCR display, downloading is complete.

Hints:

- If you use a Panasonic TV, starting the downloading of the setup data will automatically display the [Download] indication. However, in case of a TV of another brand, the [Download] indication may not appear. In this case, select the AV input on your TV if you want to see the [Download] indication.
- If you select [Schweiz], [Suisse] or [Svizzera] on the Country setting menu, the other setting menu appears automatically to let you set [Power save] to [ON]. In this setting, the VCR's power consumption is minimised when it is off (Standby mode). To turn the VCR on, keep the [VCR-ON/OFF] button pressed on the VCR main unit, not with the remote control.

Preset Download (To Set Up this VCR with a TV Already in Use)

Switch the TV on.

Select the AV input on your TV.

Set the [VCR/TV] switch to [VCR].



Press the [VCR-ON/OFF] button to switch the VCR on.

Downloading of the setup data starts automatically. (Applicable to TVs with [Q Link] or [DATA LOGIC] function)

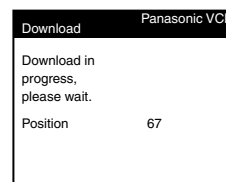

If your TV is equipped with the [Easy Link], [Megalogic] or [SMARTLINK] function, the Country setting menu appears on the TV screen. Press the [Cursor] buttons ▲▼◀▶ to select the desired country and the [OK] button. The downloading automatically starts.

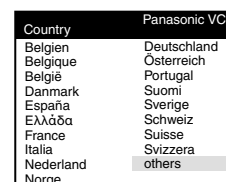

When the indication appears on the VCR display, the downloading is complete.



Hint:

- If you select [Schweiz], [Suisse] or [Svizzera] on the Country setting menu, the other setting menu appears automatically to let you set [Power save] to [ON]. In this setting, the VCR's power consumption is minimised when it is off (Standby mode). To turn the VCR on, keep the [VCR-ON/OFF] button pressed on the VCR main unit, not with the remote control.

If you are connecting your VCR to a TV using RF coaxial cable and 21-pin Scart cable, then follow the steps. (AV Connection)

(AV Connection)

RF Coaxial cable must be connected to watch TV channels even if 21-pin Scart cable is used to connect VCR to TV.

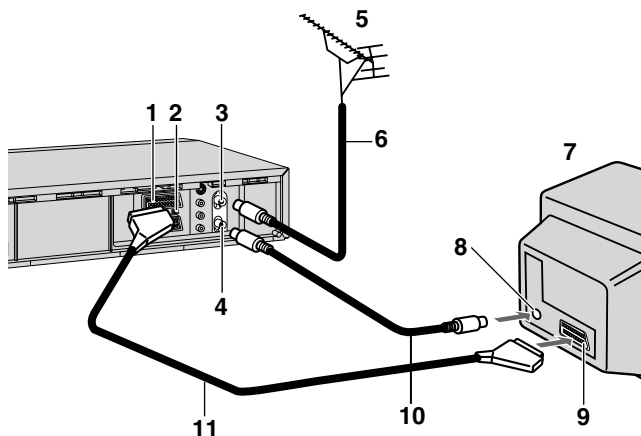

- | | |
|--------------------------------|--|
| 1 AV1 21-pin Scart socket | 7 TV (not supplied) |
| 2 Normal/S-Video Output switch | 8 Aerial Input socket |
| 3 Aerial Input socket | 9 21-pin Scart socket |
| 4 Aerial Output socket | 10 RF Coaxial cable (supplied) |
| 5 Aerial (not supplied) | 11 Fully-wired 21-pin Scart cable (not supplied) |
| 6 Aerial lead (not supplied) | |

Hint:

– If the TV set is equipped with a 21-pin Scart socket that features Y/C signal separation, set the [Normal/S-Video Output] switch on the rear panel to [S-VIDEO OUT] so that you can play back with high picture quality and use a fully-wired 21-pin Scart cable (not supplied) to connect the VCR to the TV.

If you are connecting your VCR to a TV using S-Video cable, then follow the steps. (S-Video Connection)

RF Coaxial cable must be connected to watch TV channels.

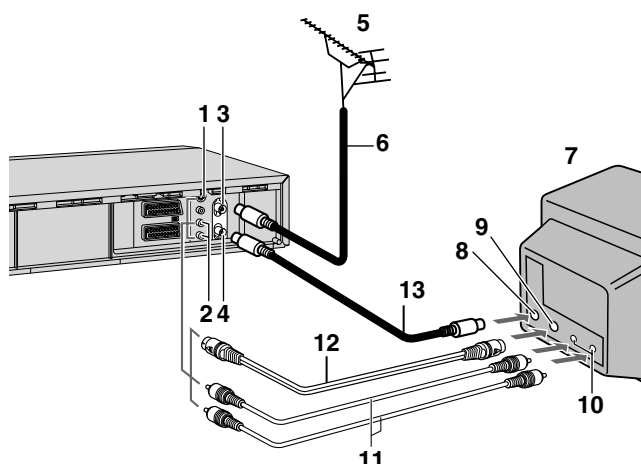

- | | |
|---|---------------------------------|
| 1 S-Video Output socket | 8 Aerial Input socket |
| 2 Audio Output socket | 9 S-Video Input socket |
| 3 Aerial Input socket | 10 Audio Input socket |
| 4 Aerial Output socket | 11 Audio cables (not supplied) |
| 5 Aerial (not supplied) | 12 S-Video cable (not supplied) |
| 6 Aerial lead (not supplied) | 13 RF Coaxial cable (supplied) |
| 7 TV with S-Video Input socket (not supplied) | |

Auto Setup Function

The Auto Setup function automatically tunes all available TV stations and sets the VCR's clock to the current date and time.

Press the [VCR-ON/OFF] button to turn on the VCR. The Country setting menu appears on the TV screen.

Country	Panasonic VCR
Belgien	Deutschland
Belgique	Österreich
België	Portugal
Danmark	Suomi
España	Sverige
Ελλάδα	Schweiz
France	Suisse
Italia	Svizzera
Nederland	others
Norge	

Press the [Cursor] buttons ▲▼◀▶. Select the country where you are using the VCR.

Press the [OK] button. The VCR's Auto Setup automatically starts and tunes all available TV stations and also sets the clock. This takes about 5 minutes. When the indication appears on the VCR display, the Auto Setup is complete.

Auto-Setup Panasonic VCR	
Country	: others
Tuning	: Ch 21



Press the [MENU] button for more than 5 seconds. The RF output channel number appears on the VCR display. The initial setting is channel 36.

Press the [Numeric] button [0]. The displayed RF output channel number changes to [-].

Press the [OK] button to conclude the setting.

To cancel the Auto Setup before it has finished

Press the [EXIT] button.

When the clock setting menu appears after Auto Setup has finished

Press the [Cursor] buttons ▲▼◀▶ to set the correct time and date.

Press the [OK] button to conclude the setting.

To confirm that the TV stations have been tuned correctly by the Auto Setup function

See page 18.

When no station has been set, confirm all connections of the VCR again and restart the Auto Setup

See page 19.

When the station names and/or channel numbers have not been set correctly

See page 18.

Hint:

– If you select [Schweiz], [Suisse] or [Svizzera] on the Country setting menu, the other setting menu appears automatically to let you set [Power save] to [ON]. In this setting, the VCR's power consumption is minimised when it is off (Standby mode). To turn the VCR on, keep the [VCR-ON/OFF] button pressed on the VCR main unit, not with the remote control.

If you are connecting your VCR to a TV using only RF coaxial cable, then follow the steps. (RF Connection)
RF Coaxial cable must be connected to watch TV channels.

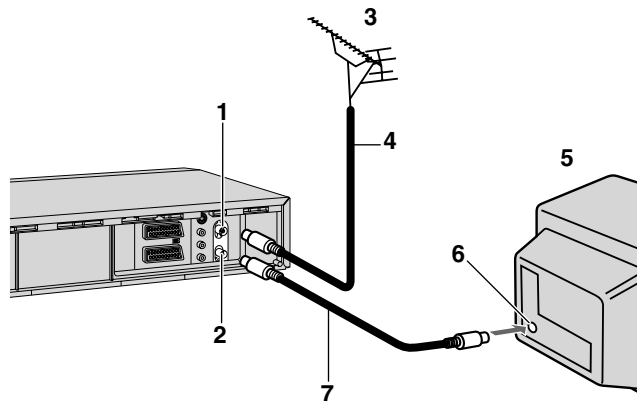

- 1 Aerial Input socket
- 2 Aerial Output socket
- 3 Aerial (not supplied)
- 4 Aerial lead (not supplied)
- 5 TV (not supplied)
- 6 Aerial Input socket
- 7 RF Coaxial cable (supplied)

To confirm that the TV stations have been tuned correctly by the Auto Setup function
See page 18.

When no station has been set, confirm all connections of the VCR again and restart the Auto Setup
See page 19.

When the station names and/or channel numbers have not been set correctly
See page 18.

Hint:

– If you select [Schweiz], [Suisse] or [Svizzera] on the Country setting menu, the other setting menu appears automatically to let you set [Power save] to [ON]. In this setting, the VCR's power consumption is minimised when it is off (Standby mode). To turn the VCR on, keep the [VCR-ON/OFF] button pressed on the VCR main unit, not with the remote control.

⏻ Press the [VCR-ON/OFF] button to turn on the VCR and tune your TV until the Country setting menu appears on the TV screen.

Country	Panasonic VCR
Belgien	Deutschland
Belgique	Osterreich
België	Portugal
Danmark	Suomi
España	Sverige
Ελλάδα	Schweiz
France	Suisse
Italia	Svizzera
Nederland	others
Norge	

Press the [Cursor] buttons ▲▼◀▶.
Select the country where you are using the VCR.

OK Press the [OK] button.
The VCR's Auto Setup automatically starts and tunes all available TV stations and also sets the clock. This takes about 5 minutes.
When the indication appears on the VCR display, the Auto Setup is complete.



If, after setup, the picture on the video playback channel is distorted, change the RF output channel on the VCR to another number.

MENU Press the [MENU] button for more than 5 seconds.
The RF output channel number appears on the VCR display.
The initial setting is channel 36.
Press the [Numeric] buttons. Change the RF output channel.
Enter a channel number which differs by 2 or 3 from the one initially set number. For example, as the original number is 36, enter 39.
Retune your TV to the VCR's new RF output channel.
Press the [OK] button to conclude the setting.



To cancel the Auto Setup before it has finished

EXIT Press the [EXIT] button .

When the clock setting menu appears after Auto Setup has finished

Press the [Cursor] buttons ▲▼◀▶ to set the correct time and date.

OK Press the [OK] button to conclude the setting.

Playback

For Normal Playback

 Press the [Play] button.



For Cue or Review Playback

 During playback, tap the [Fast Forward] or [Rewind] button.



 – To return to normal playback, press the [Play] button.

– Press and hold down the [Fast Forward] or [Rewind] button.



Cue or review playback continues for as long as you keep the button pressed.

For High speed Cue or Review Playback (JET SEARCH)

 During playback, tap the [Fast Forward] or [Rewind] button twice.



For Still Playback

 During playback, press the [Pause/Slow] button.

– To return to normal playback, press the [Play] button or the [Pause/Slow] button.



For Slow Playback

 During playback, keep the [Pause/Slow] button pressed for 2 seconds or more.

– To return to normal playback, press the [Play] button.



Fast-forwarding or Rewinding the Tape

 Press the [Fast Forward] or [Rewind] button in the stop mode.

– To stop fast-forwarding or rewinding, press the [Stop] button.

 – To briefly view the picture during fast-forwarding or rewinding, press and hold down the corresponding button.

To Stop Playback

 Press the [Stop] button.

Notes:

– JET SEARCH, Cue, review or slow playback will be automatically cancelled after 10 minutes, and still playback after 5 minutes.

– During playback function other than normal playback, horizontal noise bars may appear in the picture, the colour of the picture may be unstable, or the picture may be otherwise distorted.

When you play back a tape recorded in the LP mode, the picture may be in black and white.

When you play back a tape recorded in the EP mode, the picture and the sound may be distorted.

However, these are not malfunctions.

To Play back a Recorded Part Repeatedly

 Press the [Play] button on the remote control for more than 5 seconds.

The [R] indication appears on the TV screen.

– If [OSD] is set to [OFF] (See page 20), the [R] indication will not appear in repeat playback mode.

To Cancel the Repeat Playback Mode

 Press the [Stop] button.

To Rewind the Tape a Little to View the Same Scene Again (Replay Function)

Press the [REPLAY] button.

 REPLAY
Rewind the tape a little from its present position and play it back again.

– During review playback, when you press this button, the VCR briefly switches over to cue playback and play it back again.

– When the VCR is in the stop, rewind, fast-forward, slow playback, or standby mode, the Replay function does not work.

To Stop Playback Automatically (Playback Off Timer Function)

If you set the playback duration, the playback will stop automatically.

After the set playback time has elapsed, the VCR automatically stops playback and switches off.

 During normal playback, press the [Play] button on the VCR for more than 2 seconds to put the VCR in the Playback Off Timer mode.

After that, press this button on the VCR repeatedly until the desired playback duration is displayed on the VCR display.

– Repeatedly pressing this button changes the indication in the following order.

Counter display (normal playback mode)

→30 (min.)→60 (min.)→120 (min.)

→180 (min.)→240 (min.)

→Counter display (normal playback mode)

To stop midway

 Press the [Stop] button.

Recording

Insert a video cassette with an intact erasure prevention tab.



– If it has already been inserted, press the [VCR-ON/OFF] button to turn the VCR on.



Select the TV station using the [Channel] button. (Set the [VCR/TV] switch to [VCR].)

– It is also possible to select by pressing the [Numeric] buttons.



Press the [REC] button to start recording.



Press the [Stop] button to stop recording.

To Select the Desired Tape Speed



Press the [SP/LP/EP] button before recording.

– SP provides standard recording time and optimum picture quality.

LP provides double recording time with slightly reduced picture quality.

EP provides triple recording time with slightly reduced picture quality.



To Pause Recording



Press the [Pause/Slow] button during recording.

Press it again to continue recording.



To View One TV Programme while Recording Another TV Programme



After pressing the [REC] button to start recording, select on your TV the programme position of the TV programme that you want to view.

Notes:

- When playing back an E300 cassette recorded in the LP or EP mode, some picture distortion may occur. However, this is not a malfunction.
- The recording pause mode will be automatically cancelled after 5 minutes and return to the stop mode.
- The tape recorded in the EP mode on this VCR cannot be played back on the other VCR without EP mode function.
- On the other VCR (even with EP mode function), when you play back the tape recorded in the EP mode, the picture may be distorted. However, this is not a malfunction.

To Display the Approximate Remaining Tape Time

See page 20 to set the tape length.



Press the [OSD/DISPLAY] button repeatedly until the remaining tape time appears on the VCR display.

– Pressing the [OSD/DISPLAY] button once makes the On Screen Display appear; after that, pressing it repeatedly changes the indication in the following order.

– For certain cassettes, the remaining tape time may not be displayed correctly.

Clock→Counter→Remaining Tape Time→Clock

To Select the Recording Duration and Perform Timer Recording (OTR=One-Touch Recording)

• Press the [REC/OTR] button to start recording.



• Press the [REC/OTR] button on the VCR repeatedly to select the desired recording duration.

– Every time you press this button, the recording duration indicated in the VCR display changes in the following order.

Counter display (normal recording mode)

→30 (min.)→60 (min.)→120 (min.)

→180 (min.)→240 (min.)

→Counter display (normal recording mode)

To stop the OTR recording before the end



Press the [Stop] button.

Note:

– This function also works during Direct TV Recording.

To Prevent Accidental Erasure of Recorded Contents

Break out the erasure prevention tab after recording.

If you insert a video cassette with a broken out erasure prevention tab and press the [REC] button, the indication flashes on the VCR display to indicate that recording is not possible.

In this case, cover the tab hole with two layers of adhesive tape.

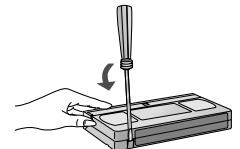

Recording from an external source

Recording from an external source, for example from a video movie camera, can be performed.

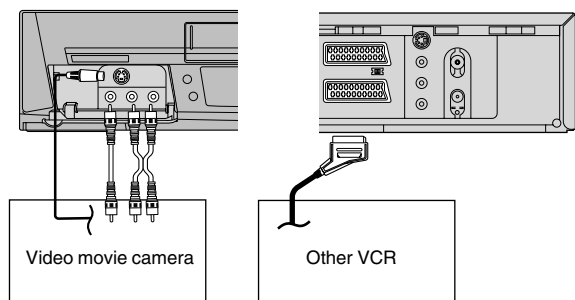

- Connect a video movie camera or a VCR to this VCR, as shown in the illustration.
- Press the [INPUT SELECT] button to select the AV Input according to the socket on the VCR to which the source unit has been connected.
 - A1: When connected to the AV1 21-pin Scart socket
 - A2: When connected to the AV2 21-pin Scart socket
 - Make sure that [AV2] is set to [EXT].
(See page 21.)
 - A3: When connected to the Video Input socket/S-Video Input socket and Audio Input sockets on the front panel of the this VCR
 - Use the L connector for operations in the normal (monaural) mode.

To Immediately Record the Same TV Programme That You Are Viewing on the TV (Direct TV Recording)

This function allows you to immediately start recording the same programme that you are viewing on the TV. The programme position selected on the VCR automatically changes to that of the TV programme that you are viewing on the TV.

- Your TV must be equipped with the [Q Link] function.
- The VCR must be connected to the TV via a fully-wired 21-pin Scart cable.

DIRECT TV REC



Press the [DIRECT TV REC] button.

- Recording of the TV programme that you are viewing on the TV starts.
- In some cases, it may not be possible to change the programme position on the TV during Direct TV Recording.
- Do not press the [AV LINK] button during Direct TV REC, otherwise the recording may not be performed correctly.



Press the [Stop] button to stop recording.



Press the [Play] button to start playback.



At the point where you want to join a new scene, press the [Pause/Slow] button to put it in the still playback mode.



Press the [REC] button to put it in the recording pause mode.

- If you leave the VCR in the recording pause mode for more than 5 minutes, the VCR automatically switches over to the stop mode to protect the video heads.

Start playback on the source unit and search for the point from which you want to record (copy) onto this VCR.



When that point is reached, press the [Pause/Slow] button again to start recording the new picture and sound from the playback unit.



To record (copy) additional scenes, press the [Pause/Slow] button to put this VCR in the recording pause mode and then perform above step again.



At the point where you want to stop recording, press the [Stop] button to finish recording.

Hint:

- The new sound is recorded on both the Hi-Fi audio tracks and the normal audio track. The sound recorded on the normal audio track is always in mono.

To Make an S-VHS Recording on a Cassette

For recordings that you intend to play back on this VCR or another S-VHS VCR, we recommend that you record in the S-VHS format to take advantage of this system's superior picture quality. Be sure to use a cassette bearing the S-VHS logo.

Insert an S-VHS cassette so that the S-VHS indicator is lit. Recording is performed in the S-VHS format.

- When a cassette that was recorded in the S-VHS format is played back on a VHS VCR without S-VHS quasi playback function, noisy playback picture will appear.

S-VHS/S-VHS ET



If you want to make a recording in the VHS format in order to play it back on a VHS VCR, press the [S-VHS/S-VHS ET] button, so that the S-VHS indicator goes out.

- Once a setting is selected, it remains in effect until the AC mains lead is disconnected.

Note:

- When receiving SECAM signals or when you set [Video system] on the Manual tuning menu or [TV system] on the Functions menu to [MESECAM] (see pages 18 and 21), recording is automatically made in the VHS format even if the S-VHS indicator is lit.

To Record a VHS Cassette with S-VHS Quality (S-VHS Expansion Technology)

S-VHS ET stands for Super-VHS Expansion Technology. This function allows recording and playback in S-VHS picture quality on a normal VHS cassette.

Recording in this format is only possible in the SP mode. If LP or EP mode is selected while setting up a timer recording, the S-VHS ET indicator turns off and S-VHS ET is cancelled.

S-VHS/S-VHS ET



Insert a VHS cassette and press the [S-VHS/S-VHS ET] button, so that the S-VHS ET indicator is lit.

Recording is performed in the S-VHS picture quality.

- When a cassette that was recorded using S-VHS ET function is played back on a VHS VCR without S-VHS quasi playback function, noisy playback picture will appear.

Notes:

- We recommend that you use cassettes other than type E300.
- When receiving SECAM signals or when you set [Video system] on the Manual tuning menu or [TV system] on the Functions menu to [MESECAM] (see pages 18 and 21), recording is automatically made in the VHS format even if the S-VHS ET indicator is lit.
- If you want to record and playback with highest possible picture quality or store the cassettes for a long time, we recommend that you use S-VHS cassettes and record in the S-VHS format.
- If you record in the S-VHS ET format, the picture quality may not be very good with certain types of cassettes. To avoid negative surprises, we recommend that you make a trial recording and confirm that the quality of the recorded picture is satisfactory. To ensure optimum picture quality, we recommend the use of high-quality type cassettes.

- We recommend entering [S-VHS ET] into the label on any cassette that you have recorded using the S-VHS ET function so that you will be able to distinguish such cassettes from VHS cassettes.

The following table lists the playback formats that are compatible with this VCR's recording standard.

Cassette	Recording format	Compatible Playback Equipment
VHS	VHS (SP/LP/EP)	VHS, S-VHS, VHS with SQPB*1
	S-VHS ET (SP)	S-VHS*2, VHS with SQPB
S-VHS	VHS (SP/LP/EP)	VHS, S-VHS, VHS with SQPB
	S-VHS (SP/LP/EP)	S-VHS, VHS with SQPB

*1 SQPB stands for S-VHS quasi playback.

*2 Some models are not compatible.

Satellite or Digital Receiver

Connecting the VCR to a Satellite Receiver or Digital Receiver

If the satellite receiver is equipped with a 21-pin scart socket

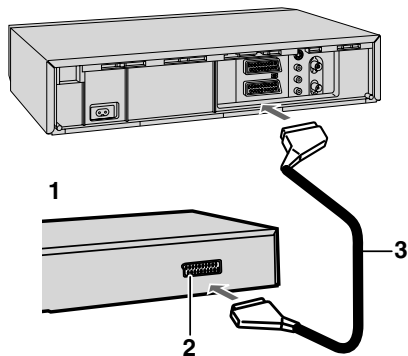

- 1 Satellite receiver (not supplied)
- 2 21-pin Scart socket
 - If your satellite receiver has a VCR socket, connect the cable to it.
- 3 21-pin Scart cable (not supplied)

Set [AV2] to [EXT], [EXT LINK 1] or [EXT LINK 2].
For details, see page 21.

If the satellite receiver is not equipped with a 21-pin scart socket

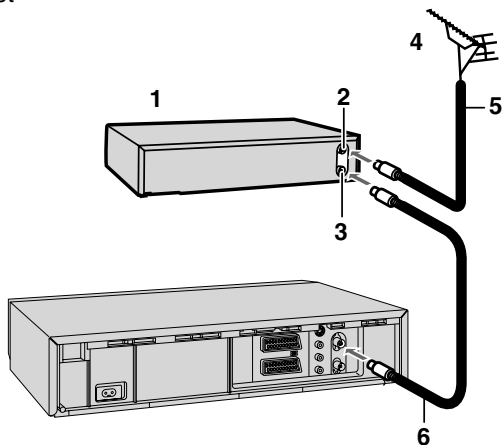

- 1 Satellite receiver (not supplied)
- 2 Aerial Input socket
- 3 Aerial Output socket
- 4 Aerial (not supplied)
- 5 Aerial lead (not supplied)
- 6 RF coaxial cable (not supplied)

Hint:

- The RF output channel of the satellite receiver should be adjusted away from channel 36, which is used by the VCR, e.g. re-adjust to channel 33.

Linked Timer Recordings by External Equipments (EXT LINK)

If an external equipment (for example a satellite receiver) with a timer function is connected to the AV2 socket of this VCR by a 21-pin cable, it is possible to control the recording of the VCR from this equipment.

Make sure that [AV2] is set to [EXT LINK 1] or [EXT LINK 2]. (See page 21.)

Timer programming has to be done on the external equipment and switch to the timer recording standby mode, refer to its operating instructions.

- EXT LINK Press the [EXT LINK] button on the VCR to switch the VCR over to the timer recording standby mode.

As long as a video picture is being transmitted by the Satellite or Digital Receiver, the VCR will record it.

This notice is displayed on the TV screen. (Only when [EXT LINK 2] is selected)

VCR now recording
this programme

- To delete it, press the [OK] button.

- EXT LINK To cancel the external control, turn off the timer recording standby mode of the VCR by pressing the [EXT LINK] button again.

Notes:

- To switch TV automatically to the picture from the VCR in playback mode, connect the AV1 socket of this VCR to the TV by a 21-pin cable.
- Some external equipments may not work with this function, refer to its operating instructions.

Timer Recording

This VCR lets you programme up to 16 TV programmes (including weekly and daily programmes) for unattended recording up to one month in advance.

To Programme with the On Screen Display (OSD)

This method offers easy step-by-step programming with the remote control while you view the prompts on the TV screen.

Example:

Programming the timer recording of a TV programme broadcast on programme position 2 (ZDF) from 20:00 to 21:30 on 27 October.

 Press the [PROG./CHECK] button to display the menu for programming timer recordings on the TV screen.

– Alternatively, you can press the [MENU] button and then select [Timer recording].

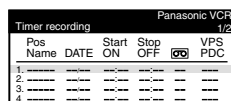



Pos	Name	DATE	Start	Stop	OFF	VPS	PDC
1							
2							
3							
4							

 Press the [Channel] button to select the programme position of the desired TV station.
– As an alternative method, after pressing the [Channel] button, you can use the [Cursor] buttons ▲▼◀▶.

 Press the [DATE] button to set the date on which the TV programme will be broadcast.

 Press the [ON] button to set the starting time.
– When it is kept pressed, the indication changes in 30-minute intervals.

 Press the [OFF] button to set the ending time.

 Press the [SP/LP/EP] button to set the desired tape speed.
– Regarding the [A] indication, refer to page 15.

Press the [Cursor] buttons ▲▼◀▶ to set [VPS/PDC] to [ON] or [OFF] [---].
– See page 15 for VPS/PDC recording.

 Press the [OK] button to conclude the setting.

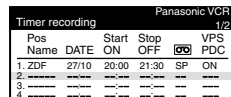

Pos	Name	DATE	Start	Stop	OFF	VPS	PDC
1	ZDF	27/10	20:00	21:30	SP	ON	
2							
3							
4							

 Press the [TIMER] button to switch the VCR over to the timer recording standby mode.
– Check that [□] is lit on the VCR display.
If it is flashing, check the timer recording details again. (See page 15.)

To Programme with the ShowView Function

The ShowView numbers make it extremely easy to set the VCR for timer recording.

The duration of a timer recording programmed with ShowView number may be slightly longer than the actual duration of the TV programme.

SHOWVIEW is a trademark of Gemstar Development Corporation. The SHOWVIEW system is manufactured under licence from Gemstar Development Corporation.

Example:

Programming a timer recording of a TV programme with the ShowView number 721114

 Press the [SV/V+] button to display the menu for entering the ShowView number on the TV.

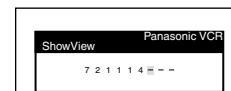

Press the [Numeric] buttons to enter the ShowView number.

– If you have entered a wrong digit, press the [Cursor] button ◀ and then enter the correct digit.

 Press the [OK] button to display the programmed content.

 Press the [SP/LP/EP] button to set the desired tape speed.

– Regarding the [A] indication, refer to page 15.

– To change timer recording programmings, use the [Cursor] buttons ▲▼◀▶, the [Channel], [DATE], [ON] or [OFF] button.

– See page 15 for VPS/PDC recording.

 Press the [OK] button again to conclude the settings.

 Press the [TIMER] button to switch the VCR over to the timer recording standby mode.

– Check that [□] is lit on the VCR display.

If it is flashing, check the timer recording details again. (See page 15.)

To Suspend the Timer Recording Standby Mode

Press the [TIMER] button so that the [□] indication on the VCR display disappears.

After you have finished using the VCR, be sure to reactivate the timer recording standby mode by pressing the [TIMER] button again, otherwise the programmed timer recording will not be performed.

Note:

– If the VCR is not put in the timer recording standby mode at the latest 10 minutes before the programmed timer recording starting time, the [□] flashes on the VCR display. In this case, press the [TIMER] button to put the VCR in the timer recording standby mode.

If [--] Appears under [Pos/Name] after Entering a ShowView Number

Pos/Name stands for Programme Position/TV Station Name. Normally, the name of the TV station or the number of the programme position is displayed under [Pos/Name]. However, if the [--] indication appears, follow the operation steps below.



Press the [Channel] button repeatedly to select the programme position on which the TV programme to be recorded will be broadcast.

After you have entered the information of a TV station, it remains stored in the VCR's memory, and you do not need to enter it again in the future.

Setting the Recording Date/Day(s)



Press the [DATE] button to select the recording date (1 to 31), daily timer recording date (Su–Sa, Mo–Sa or Mo–Fr) or weekly timer recording date (Su to Sa).

- Programming a timer recording (setting the date) is possible up to one month ahead of the TV programme's broadcasting date and time. Daily and weekly timer recordings will continue until you cancel them.

Auto SP/LP Change Function

If the VCR determines that the remaining tape time is insufficient to record the whole programme, LP mode is automatically selected to ensure that the programme will be recorded as long as possible.



Press the [SP/LP/EP] button to select [A].

- This function cannot change the recording speed to the EP mode.
- If the remaining tape time is still not sufficient even in the LP mode, the programme cannot be recorded to its end.
- If the recording speed changes from SP to LP during a timer recording, some brief picture distortion occurs at that point.

VPS/PDC Function

If a TV programme, for example a football game runs longer than scheduled, is shortened or starts earlier or later, this function synchronises the recording start and stop with the actual broadcasting start and stop of the TV programme.

Press the [Cursor] buttons ▲▼◀▶ to make the [ON] indication appear.

- [ON] must be displayed under [VPS/PDC] on the TV screen.
- The TV station must broadcast VPS/PDC signals.
- The programme starting time must be set correctly to the starting time listed in the newspaper/magazine.

To Check, Change or Cancel Timer Recording Programmings



Press the [PROG./CHECK] button to display the timer recording programmings on the TV screen.

- When the VCR is in the timer recording standby mode for a VPS/PDC recording, the On Screen Display may be distorted.

Press the [Cursor] buttons ▲▼ to select the programming that you want to change or cancel.

To change or cancel timer recording programmings, use the [Cursor] buttons ▲▼◀▶, the [Channel], [DATE], [ON], [OFF] or [CANCEL] button.



Press the [OK] button to conclude the setting.



Press the [EXIT] button to exit the On Screen Display.

Note:

In some cases, for example as listed below, the programming of a timer recording remains stored in the memory until 4 a.m. the next day. However, this is not a malfunction.

- When a timer recording was not performed up to the TV programme's ending time because the remaining tape time was not sufficient.
- When you have stopped the timer recording while it was being performed.

To Check the Total Timer Recording Programming Time

The total time indication for timer recording programming lets you check how many programmes can be recorded by comparing with the remaining tape time in the VCR display.

1	---	---	---	---	---
2	---	---	---	---	---
3	---	---	---	---	---
4	---	---	---	---	---
5	---	---	---	---	---
6	---	---	---	---	---
7	---	---	---	---	---
8	---	---	---	---	---
9	---	---	---	---	---
0	---	---	---	---	---
Total (SP) 90min					

- The total time is calculated in the SP mode.
- The total time cannot be calculated when setting Daily/Weekly timer recording.

Search Functions

Programme List Search

- Each timer recording programming on the tape must be at least 15 minutes long. (25 minutes in the EP mode)

 Press the [SEARCH] button to display the Programme List menu.

Programme List				Panasonic VCR
	Pos	Name	Date	Start
1.	ZDF	27/10	17:46	
2.	ARD	28/10	15:00	

Press the [Cursor] buttons ▲▼ to select the programme that you want to locate and play back.

 Press the [SEARCH] button to start the search for the beginning of the selected programme.

- After the desired recorded programme has been found, playback starts automatically.
- If, after playback has started, you want to search for the beginning of the same or another programme, press the [SEARCH] button. Playback stops, and the Programme List menu appears.

To Cancel the Programme List Search

 Press the [EXIT] button.

Notes:

- If you take out the cassette after a timer recording has finished, pressing the [SEARCH] button activates the Intro-Jet Scan.
- If you programme linked timer recordings, Programme List Search function does not work.

VISS=VHS Index Search System

- Each programme recorded on the tape must be at least 5 minutes long.

 Press the [INDEX] button to start the index search. If you want to search for the 2nd recorded programme in forward direction, press the [INDEX] ►►► button twice.

- The VCR fast-forwards or rewinds the tape and searches for the specified index signal. When it has been found, playback starts automatically.

To Cancel the Index Search or to Stop Playback

 Press the [Stop] button.

Intro-Jet Scan

- Each programme recorded on the tape must be at least 15 minutes long. (25 minutes in the EP mode)

 Press the [SEARCH] button to start the Intro-Jet Scan.

- After rewinding the tape to the beginning, the VCR plays it back at high speed for approximately 10 seconds. It then fast-forwards the tape to the next tape position marked by an index signal (beginning of a programme), and every time an index signal is found, the VCR switches over to high-speed playback (Cue) for about 10 seconds.

 When you have found the programme that you want to view, press the [Play] button to start normal playback.

To Cancel the Intro-Jet Scan or to Stop Playback

 Press the [Stop] button.

Note:

- If you press the [SEARCH] button after a timer recording has finished, but before ejecting that cassette, the Programme List Search will be activated.

Editing

Album Function

The album function lets you collect desired scenes (both moving and still pictures) and create the equivalent of a photo album, but on video cassette.

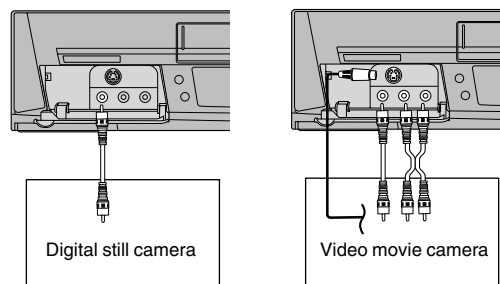

- Connect a digital still camera, a video movie camera or another external source to the Video Input socket/S-Video Input socket and Audio Input sockets on the front panel of this VCR.

 Press the [STILL ALBUM] button on the remote control to put the VCR in the recording pause mode.

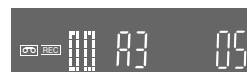

- The VCR automatically selects the AV Input (external input) [A3] and then switches over to the recording pause mode. The figure for the preset recording time (seconds) appears on the VCR display. The initial setting is [05] (5 seconds).

 Press the [INDEX] ►►► or [INDEX] ◀◀◀ button to change the recording time. You can set any time between [3] and [20] seconds.

Start playback on the source unit to search for the point from which you want to copy onto this VCR.

 When that point is reached, press the [STILL ALBUM] button on the remote control again to start recording.

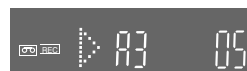

The VCR records the picture (and sound) for 5 seconds and then automatically switches over to the recording pause mode.

 When you have recorded all desired scenes, press the [Stop] button to finish recording.

Hints:

- If you connect a digital still camera, use a camera equipped with the video output socket. Use the cable supplied with the still camera to connect it. For details, also read the operating instructions of the equipment to be connected.
- If you leave the VCR in the recording pause mode for more than 5 minutes, the VCR automatically switches over to the stop mode to protect the video heads. In this case, press the [STILL ALBUM] button again to put the VCR in the recording pause mode again.
- Depending on the output system of the digital still camera, the pictures may not be recorded correctly.
- If you dub still pictures from a conventional analogue video movie camera or VCR, some picture distortion may occur in the recorded picture.

Connecting a Decoder

Decoder here refers to the device used to decode scrambled broadcasts (Pay TV).

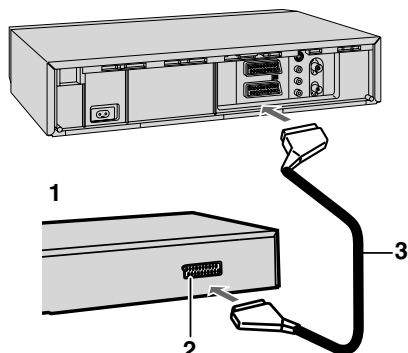

- 1 Decoder (not supplied)
- 2 21-pin Scart socket
- 3 21-pin Scart cable (not supplied)

Connect a 21-pin Scart cable (not supplied) to the AV2 21-pin Scart socket on the VCR and to the 21-pin Scart socket on the decoder.

Connect the decoder's mains lead to an AC mains socket.

Set [AV2] to [DECODER].

For details, see page 21.

AV Link Function

If the VCR is connected to the TV via a 21-pin Scart cable, you can use the [AV LINK] button to switch the TV from normal TV reception over to the video playback channel (AV input) (and vice versa). In the VCR mode (when the [VCR] indication in the VCR display is lit), the TV is switched to the video playback channel (AV input). In the TV mode (when the [VCR] indication is not lit), the TV is switched to TV reception.

- When you press the [MENU] button to display the menu on the TV screen, the TV is also automatically switched to the VCR mode, however, the [VCR] indication does not appear in this case.
- When you start playback on the VCR, the TV is automatically switched to the VCR mode. However, during playback, it is not possible to switch the TV back to the TV mode.
- If a Pay TV station has been selected on the VCR when you switch to the TV mode, the picture on the TV is scrambled when you select a Pay TV station on the TV. In this case, either switch to the VCR mode or select the AV input on the TV.

Hint:

- [RGB] means separate Red/Green/Blue colour signals. If you connect a TV equipped with RGB input capability to the AV1 socket on this VCR, and a decoder equipped with RGB output capability to the AV2 socket, the TV can receive RGB signal input from the decoder via the VCR.

Connecting a Stereo Amplifier

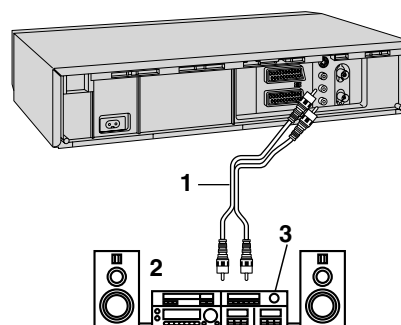

- 1 Audio cable (not supplied)
- 2 Stereo amplifier (not supplied)
- 3 Audio Input sockets

Connect an Audio cable (not supplied) to the Audio Output sockets on the VCR and to Audio Input sockets on the stereo amplifier.

Connect the stereo amplifier's mains lead to an AC mains socket.

Manual Tuning

This VCR has 99 programme positions that can be preset to receive TV stations.

If available TV stations are not received due to extraordinary transmission circumstances, or if you want to change the name of a TV station or change a TV station, you can set it up manually.

 Press the [MENU] button to display the Main menu on the TV screen.

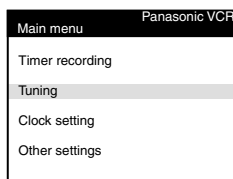

Press the [Cursor] buttons ▲▼ to select [Tuning].

 Press the [OK] button to display the Tuning menu on the TV screen.

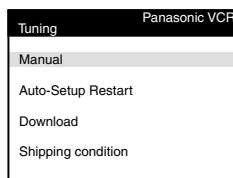

Press the [Cursor] buttons ▲▼ to select [Manual].

 Press the [OK] button to display the list of tuned TV stations.

Pos	Name	Ch
1	ARD	1
2	ZDF	2
3	N3	19
4	HR3	26
5	BR3	18
6	RB3	3
7	SFB3	36
8	SW3	29

Press the [Cursor] buttons ▲▼ to select the TV station that you want to tune manually.

 Press the [OK] button to display the Manual Tuning menu.

Pos	:	5
Name	:	BR3
Channel	:	18
Fine tuning	:	AUTO
Decoder	:	OFF
Video system	:	AUTO
Mono	:	OFF

Press the [Cursor] buttons ▲▼◀▶ to select the desired field.

Pos: To change the order in which the TV stations are assigned to the programme positions.

- Press the [Numeric] buttons to enter the number of the desired programme position.

Name: To enter or change the name of a TV station.

- Press the [Cursor] buttons ▲▼◀▶ and [OK] button to enter the station name.
- If the station name needs a blank space, select the blank between [Z] and [*].

Channel: To enter newly available TV stations or change the channel number of an already tuned TV station.

- Press the [Numeric] buttons to enter the channel number of the desired TV station.
- Wait a few moments until the desired TV station has been tuned.

Fine tuning: To obtain the best tuning condition.

- Press the [Cursor] buttons ▲▼ to obtain the best tuning condition.
- If you do not want to change the tuning condition, press the [Cursor] button ▶ to return to the original condition [AUTO].

Decoder: To preset pay TV stations.

- Press the [Cursor] buttons ▲▼ to select [ON].
- If [Decoder] is set to [OFF], normal TV stations are preset.

Video system: To change the type of video system.

- Press the [Cursor] buttons ▲▼ to select [PAL] or [MESECAM].

AUTO: The VCR automatically distinguishes PAL, SECAM/MESECAM system.

PAL: For receiving PAL signals.

MESECAM: For receiving SECAM signals.

Mono: To select the type of sound to be recorded.

(For NV-HS820EC Series)

- Press the [Cursor] buttons ▲▼ to select [OFF].
- Select [ON] if you want to record the normal (mono) sound on the Hi-Fi audio tracks during a stereo, bilingual or NICAM broadcast, or if the stereo sound is distorted due to inferior reception conditions.

 Press the [OK] button to conclude the setting.

 Press the [EXIT] button to exit the On Screen Display.

To Delete, Add or Move a Programme Position

 Press the [MENU] button to display the Main menu on the TV screen.

Press the [Cursor] buttons ▲▼ to select [Tuning].

 Press the [OK] button to display the Tuning menu on the TV screen.

Press the [Cursor] buttons ▲▼ to select [Manual].

 Press the [OK] button to display the list of tuned TV stations.

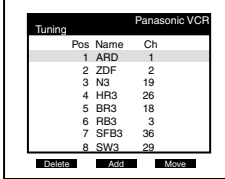

Pos	Name	Ch
1	ARD	1
2	ZDF	2
3	N3	19
4	HR3	26
5	BR3	18
6	RB3	3
7	SFB3	36
8	SW3	29

Press the [Cursor] buttons ▲▼ to select the desired TV station.

 Follow the operations below.

To delete a programme position [Delete]:

Press the [Channel] button (▲, red).

To insert a blank programme position [Add]:

Press the [DATE] button (+, green).

To move a TV station to another programme position [Move]:

Press the [ON] button (+, yellow), and then use the [Cursor] buttons ▲▼ to select the new programme position to which you want to assign the TV station.

 Press the [OK] button to conclude the setting.

 Press the [EXIT] button to exit the On Screen Display.

Note:

- If downloading of the setup data has been performed, only the instruction indication [Delete] appears.

Hint:

- If you have performed Manual Tuning to enter TV stations, the [–] indication may appear under [Pos/Name] on the On Screen Display when programming a ShowView timer recording.

To Restart the Auto Setup, Restart the Download or Return the VCR to the Shipping Condition

 Press the [MENU] button to display the Main menu on the TV screen.

Press the [Cursor] buttons ▲▼ to select [Tuning].

 Press the [OK] button to display the Tuning menu on the TV screen.

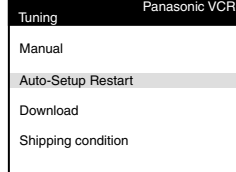

Tuning	Panasonic VCR
Manual	
Auto-Setup Restart	
Download	
Shipping condition	

Press the [Cursor] buttons ▲▼ to select [Auto-Setup Restart], [Download] or [Shipping condition].

 Press the [OK] button to prepare for Auto Setup start, Download start or resetting the VCR to the shipping condition.

 Press the [OK] button again to actually start the Auto Setup, start the Download or change the settings back to the shipping condition.

- After returning the VCR to the shipping condition, disconnect and reconnect the AC mains lead to re-tune the VCR.

Setting the VCR's Clock

To Manually Adjust the Clock

MENU Press the [MENU] button to display the Main menu on the TV screen.



Press the [Cursor] buttons ▲▼ to select [Clock setting].

OK Press the [OK] button to display the Clock setting menu on the TV screen.

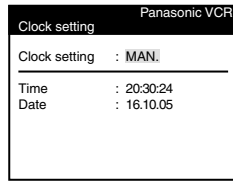

OK Confirm that [Clock setting] is set to [MAN.], and then press the [OK] button.

Use the [Cursor] buttons ▲▼◀▶ to set the date and time.

– Instead of the [Cursor] buttons ▲▼◀▶, you can also use the [Numeric] buttons to set the date and time.

OK Press the [OK] button to conclude the setting.

EXIT Press the [EXIT] button to exit the On Screen Display.



To Activate the Automatic Time Correction Function

If a TV station transmits a signal for time setting, performing the operation steps below activates the Automatic time correction function and the time is corrected automatically.

MENU Press the [MENU] button to display the Main menu on the TV screen.



Press the [Cursor] buttons ▲▼ to select [Clock setting].

OK Press the [OK] button to display the Clock setting menu on the TV screen.

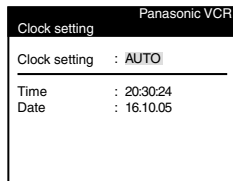

Press the [Cursor] buttons ▲▼ to set [Clock setting] to [AUTO].

OK Press the [OK] button to conclude the setting.

– Under adverse reception conditions, etc., the Automatic time correction function may not work. In this case, the indication for [Clock setting] is automatically reset to [MAN.].
If the reception conditions improve later on, it may be possible to activate this function.

EXIT Press the [EXIT] button to exit the On Screen Display.



Hints:

- If [Clock setting] is set to [AUTO] when you open the Clock screen, do not set it to [MAN.], otherwise, the automatic time correcting function is deactivated.
- The built-in clock employs the 24-hour system.
- In case of a power failure, an automatic back-up system automatically maintains the operation of the clock for approximate 60 minutes.
- When [Clock setting] is set to [AUTO], the automatic time correction function checks and if necessary adjusts the time several times every day.
The automatic time correction function only works when the VCR is switched off; it does not work in the timer recording standby mode.
- If [Clock setting] is set to [MAN.] and [Power save] to [ON] (see page 21), the time may not be maintained correctly. In this case, manually adjust the clock.

- If [Clock setting] is set to [AUTO] and [Power save] to [ON], the Automatic time correction function does not work while the VCR is turned off. However, as soon as it is turned on, the Automatic time correction function is activated and the clock is set correctly.

Various Settings

MENU Press the [MENU] button to display the Main menu on the TV screen.



Press the [Cursor] buttons ▲▼ to select [Other settings].

OK Press the [OK] button to display Other settings menu.

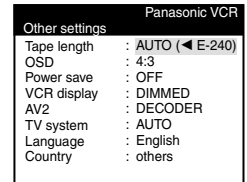

Press the [Cursor] buttons ▲▼◀▶ to select the desired field then desired position.

Tape length: To set the Tape length of the cassette being used to ensure correct indication of the remaining tape time.

– Set Tape length as follows:

[AUTO (◀ E-240)]: The VCR automatically distinguishes E30, E60, E90, E120, E180, E240, EC10, EC15 and EC30 tapes.

[E-195]: For E195 and EC30 tape

[E-260]: For E260 and EC45 tape

[E-300]: For E300 and EC60 tape

– Even if you have selected the correct tape length, the remaining tape time may not be indicated correctly with certain kinds of cassettes.

OSD: For automatic display on the TV screen of the TV station information, type of sound system of the programme being watched and the sound playback mode. (See page 22.)

– Set OSD mode as follows:

[4:3]: Indications can be displayed on the TV screen.

[16:9]: Indications can be displayed on the TV screen when using wide type of TV screen and selecting the wide screen mode on the TV setting.

– Even if setting to [16:9], indications may be cut off depending on the TV.

[OFF]: No indications appears.

- Power save:** To reduce the VCR's power consumption when the VCR is switched off.
- Set Power save mode as follows:
- [ON]:** The power consumption is greatly reduced when the VCR is turned off.
- [OFF]:** The power consumption is not reduced when the VCR is turned off.

Refer to the followings when [Power save] is set to [ON].

- [VCR display] is automatically set to [OFF].
- To turn the VCR on, keep the [VCR-ON/OFF] button pressed on the VCR main unit. It is not possible to turn it on with the remote control.
- The Power save function does not work in the timer recording standby mode. After all programmed timer recordings have been made, and after all programmed data have been erased, the VCR switches over to the Power save mode.
- When the VCR is off, Pay TV programmes cannot be watched on the TV because the signal from the connected decoder is not looped through. To watch them, turn on the VCR.

- VCR display:** For automatic change of the brightness of the VCR display when the VCR is switched off.
- Set the brightness of the VCR display as follows:
- [ON]:** Indications are brightly lit.
- [OFF]:** Indications are not lit.
- [DIMMED]:** Indications are dimly lit.

- AV2:** To select the type of external source equipment which is connected to the VCR's AV2 21-pin socket.
- Set the external source equipment as follows:
- [DECODER]:** When a decoder is connected.
- [EXT LINK 1]:** When a digital receiver which transmits a special control signal recordings via the 21-pin Scart cable, for example the F.U.N. receiver (TU-DSF30/S3) is connected for the linked timer recordings. (See page 13.)
- [EXT LINK 2]:** When an external equipment with a timer function is connected for the linked timer recordings. (See page 13.)
- [EXT]:** When another VCR or a satellite receiver is connected.

- TV system:** To select the type of colour TV system to be used during playback or during recording from an external source.
- Set the colour TV system as follows:
- [AUTO]:** The VCR automatically distinguishes PAL, SECAM/MESECAM system. If the picture lacks colour, set to [PAL] or [MESECAM].
- [PAL]:** When PAL system is used.
- [MESECAM]:** When SECAM system is used.

Language or Country Setting

 Press the [MENU] button to display the Main menu on the TV screen.

Press the [Cursor] buttons ▲▼ to select [Other settings].

 Press the [OK] button to display Other settings menu.

Panasonic VCR	
Other settings	
Tape length	: AUTO (◀ E-240)
OSD	: 4:3
Power save	: OFF
VCR display	: DIMMED
AV2	: DECODER
TV system	: AUTO
Language	: English
Country	: others

Press the [Cursor] buttons ▲▼◀▶ to select [Language] or [Country] and the entry field for [Language] or [Country] in this order.

Press the [Cursor] buttons ▲▼ to select the desired language or country.

 Press the [OK] button to conclude the setting.

 Press the [EXIT] button to exit the On Screen Display.

 Press the [OK] button to conclude the setting.

 Press the [EXIT] button to exit the On Screen Display.

Other Function

Indications that Can Be Displayed on the TV Screen

 At a press of the [OSD/DISPLAY] button, the following indications appear on the TV screen.

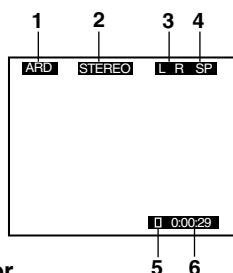

1 TV station name

2 STEREO or BILINGUAL Indicator (For NV-HS820EG Series)

When receiving a TV programme, the type of sound system in which it is broadcast is automatically indicated.

STEREO, M1 and M2 Indicator (For NV-HS820EC Series)

When receiving a TV programme with the Stereo, Bilingual or NICAM sound system, the type of sound system in which it is broadcast is automatically indicated.

STEREO: When receiving a Stereo/NICAM stereo broadcast.

M1/M2: When receiving a Bilingual/NICAM dual-sound broadcast.

M1: When receiving a NICAM monaural broadcast.

3 Sound mode during playback (L/R)

 At each press of the [AUDIO] button, the selected playback sound is indicated with L (Left) and R (Right).

Stereo playback:

The L and R indications are displayed.

Left audio channel playback:

The L indication alone is displayed.

Right audio channel playback:

The R indication alone is displayed.

Playback of normal audio track:

Neither L nor R indication is displayed.

4 Tape speed indicator

5 Tape running display

6 Present time/Tape counter/Remaining tape time/Index Search/One-Touch Recording (OTR)/Playback Off Timer Function

Present time	17:24:31
Tape counter	- 2:35.47
Remaining tape time	REMAIN: 2:34
Index Search	▶▶ 02
One-Touch Recording (OTR)	OTR 60
Playback Off Timer Function	30

Notes:

- If [OSD] is set to [OFF], none of the above indications appear.
- None of the above indications appear during special playback.
- During playback and when the AV input for the external source is selected, indications 1 and 2 do not appear.

- Some of the above indications do not appear when using NTSC tapes.

To Play Back NTSC Video Cassettes on Your PAL TV (Quasi-NTSC Playback Function)

This VCR allows playback of tapes recorded in the NTSC system on a normal PAL system TV with the same operations as usual.

On some TVs, however, the playback picture may roll up or down.

- If your TV has a V-HOLD control or equivalent adjustment function, use it to try to stop the picture movement.

Crystal View Control (CVC)

The crystal view control function ensures that you always obtain the optimum picture quality so that you get the best picture automatically.

While the VCR is turned on, the [CVC] indication is always displayed to show that the Crystal View Control is activated.

Convenient Automatic Functions

VCR Auto Power On

When you insert a video cassette, the VCR switches on automatically.

Auto Playback Start

When you insert a video cassette with a broken erasure prevention tab, playback start automatically without having to press the [Play] button.

VCR-off Playback

When the VCR is off, an inserted cassette can be played back by pressing the [Play] button.

Auto Rewind

When the tape reaches the end, the VCR automatically rewinds it to the beginning.

- This function does not work during timer recording and OTR.

Automatic Switching Off and Ejection

When the VCR is switched off, and inserted cassette can be ejected simply by pressing the [EJECT] button. The VCR will eject the cassette and automatically turn itself off again.

VCR-off Search

When the VCR is off, the VCR starts Intro-Jet Scan of an inserted cassette by pressing the [SEARCH] button.

Adjusting the Playback Picture

Under normal conditions, the VCR automatically adjusts the playback picture for optimum quality. However, in some cases it may be necessary to adjust it manually.

If noise bars appear during normal playback, slow playback or still playback, follow the operations below.



During normal or slow playback, press the [Channel] button ∇ (–) or \wedge (+) until the bars noise disappear.

- If the noise bars appear during still playback, switch the VCR over to the slow playback mode and then adjust the tracking as explained above.

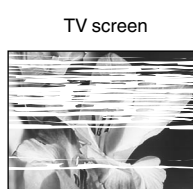

TV screen
Playback picture containing noise bars



Press the [Channel] buttons ∇ (–) and \wedge (+) simultaneously to return to Auto Tracking.

If the still picture scrolls up or down, perform the following operation.



During still playback, keep the [Channel] button ∇ (–) or \wedge (+) pressed until the picture stops scrolling.

Precautions:

- With certain TV models and tapes, it may not be possible to adjust the tracking.
- If you play back a cassette that was recorded on another VCR, the picture quality may be inferior and it may be necessary to adjust the tracking. Also, on some TVs, the picture may scroll up and down in the special playback functions.

However, these are not malfunctions.

NICAM Broadcasting System

(For NV-HS820EC Series)

NV-HS820EC Series feature the NICAM digital sound system, a 2-channel sound broadcast system that provides either 2 high-quality stereo sound tracks or 2 independent mono sound tracks, M1 and M2.

NICAM programmes are always accompanied by standard (mono) sound broadcasts, and during playback, you can select the desired sound with the [AUDIO] button.

- The NICAM stereo sound can only be recorded on the Hi-Fi audio tracks.
- If, for some reason, you want to record a stereo, bilingual or NICAM TV programme intentionally in mono on the Hi-Fi audio tracks, set [Mono] to [ON] for the programme position on which the desired programme is broadcast, as described on page 18.

Before Requesting Service

On Screen Display Messages

The error messages are given in brackets [].

[Please insert video tape!]

- You pressed the [REC] button, [REC/OTR] button, the [DIRECT TV REC] button, the [Play] button, the [Fast Forward] button, the [Rewind] button or the [SEARCH] button when no cassette was inserted in the VCR.
- You pressed the [TIMER] button when no cassette was inserted in the VCR with a timer recording programmed. Insert a video cassette.

[Please use tape with unbroken recording tab !]

- You pressed the [REC] button, [REC/OTR] button or the [DIRECT TV REC] button when a cassette with a broken out erasure prevention tab was inserted in the VCR.
- You pressed the [TIMER] button when a cassette with a broken out erasure prevention tab was inserted in the VCR with a timer recording programmed. Insert a video cassette with an intact erasure prevention tab on which recording is possible.

[This action is not possible before time and date are set]

- You pressed the [SV/V+] button or the [PROG./CHECK] button, even though the time and date have not yet been set on the VCR. Set the time and date.

[No timer programmes to be done!]

- You pressed the [TIMER] button even though no timer recording has been programmed. Programme a timer recording before pressing the [TIMER] button.

[Please put VCR into stop mode first]

- You attempted to change the contents of the timer programming while a timer recording was being performed. Put the VCR into the stop mode first.

Other messages may also appear.

Follow the instructions given on the TV screen.

The VCR Does Not Work Correctly

[The VCR display is not illuminated.]

- The AC mains lead is disconnected.
Connect the AC mains lead securely.
- VCR display setting is [OFF]. Set [VCR display] to [ON] or [DIMMED]. (See page 21.)
- Power save setting is [ON]. (See page 21.)

[The VCR display is illuminated, but the VCR cannot be operated.]

- The VCR is in the timer recording standby mode.
Press the [TIMER] button to cancel the standby mode.
- Safety devices are operating.
Disconnect the AC mains lead and wait approximately 1 minute before reconnecting.
Then check if the VCR can be operated.

[The VCR picture does not appear on the TV screen.]

- The RF output channel is set to [- -].
Change the RF output channel to a channel other than [- -]. (See page 8.)

[Auto clock setting does not work correctly.]

- Teletext information is not available or cannot be read.
Set the clock manually.

[Download cannot be performed.]

- The VCR is not connected to a TV equipped with the Q Link (or a similar) function via a fully-wired 21-pin Scart cable.
Be sure to use a fully wired 21-pin Scart cable to connect the VCR to a TV with the Q Link (or a similar) function.

Playback Does Not Work Properly

[The playback picture is distorted or in black and white.

Or, horizontal noise bars appear in the picture or horizontal lines move up and down.]

- The tracking adjustment is not correct.
Adjust the tracking. (See page 23.)
- The TV's video playback channel has not been tuned correctly.
Re-tune the video playback channel.
- The video heads are clogged or worn.
Consult your dealer for advice.
- The playback picture is distorted when using an E300 type video cassette that was recorded in the LP or EP mode.
We recommend that you use video cassettes other than type E300.
- The playback picture is distorted when you record the tape in the EP mode using MESECAM system.
However, this is not a malfunction.
We recommend PAL system for recording in the EP mode.
- During high speed cue and review playback (JET SEARCH), the tape transport noise will increase.
However, this is not a malfunction.

Recording Is Not Possible or Does Not Work Properly

[When recording is attempted, the  indication flashes.]

- A video cassette with a broken out erasure prevention tab is used.

Use a cassette with an intact tab, or if you want to erase the previously recorded contents on the cassette, cover the tab hole with two layers of adhesive tape.

[The playback picture of a recorded programme is distorted or no picture can be seen.]

- The aerial or aerial lead connection is defective.
Check the connections. If the picture displayed on the TV is also distorted, there is something wrong with the installation of the aerial.
- No programme was recorded because the VCR is not tuned correctly.
Tune it correctly.
- No programme was recorded because the AV input was selected on the VCR.
Select the programme position of the desired TV programme.

[Timer recording does not work correctly.]

- Time and date are not set or they are set incorrectly.
Set the time and date correctly.
- The starting time or ending time of the timer recording were not programmed correctly.
Set the starting time or ending time correctly.
- The VCR was not put in the timer recording standby mode.
After programming a timer recording, press the [TIMER] button to put the VCR in the timer recording standby mode.

[Recording from an external source connected to the VCR's AV input cannot be made.]

- The correct AV input is not selected.
Select the correct AV input.
- The connections from the external source are not made correctly. Correct them. (See page 11.)

The Remote Control Does Not Work Correctly

[The remote control does not work correctly.]

- The remote control signal cannot reach the VCR.
Aim the remote control at the VCR and make sure that the infrared beam's path is not obstructed.
- The distance to the VCR is too long.
Use the remote control within 7 metres from the VCR. If you are using it within this range but the remote control still cannot operate the VCR, replace the batteries.
- The batteries are exhausted.
Replace with new batteries.
- The batteries have been inserted with reversed polarities (\oplus and \ominus).
Insert the batteries correctly. (See page 2.)
- Power save setting is [ON]. (See page 21.)

Index

	Page		Page
Audio	22	Q Link	5
Auto Setup	7, 19	Recording	10
AV input	4	Remaining tape time	10
AV link	17	Repeat	9
Battery	2	Replay	9
Child lock	4	Reset	4
Clock setting	20	Review	9
Condensation	2	Rewind	9
Country setting	6, 7, 8, 21	RF	5, 7, 8
Cue	9	Satellite receiver	13
CVC	22	Scart cable	5, 7
Decoder	17, 18, 21	Shipping condition	19
Digital receiver	13	ShowView	14
Direct TV recording	11	Slow playback	9
Download	6, 19	SP	10, 14, 15
EP	9, 10, 14	Stereo	22
Erasure protection	10	Still album	16
EXT LINK	13, 21	Still playback	9
Fast forward	9	Stop	9
Fine tuning	18	S-VHS	12
Hi-Fi	11, 18, 23	S-VHS ET	12
Intro-jet scan	16	Tape length	10, 20
JET SEARCH	9	Tape speed	9, 10, 14, 15, 22
Language setting	21	Teletext	4
LP	9, 10, 14, 15	Timer recording	14, 15
Manual tuning	18	Tracking	23
Menu	4	TV aspect	4
MESECAM	18, 21	TV system	21
Mono	18	VCR display	21
NICAM	23	Video system	18
NTSC playback	22	VISS	16
OSD	20, 22	Volume	4
OTR	10	VPS/PDC	15
PAL	18, 21		
Playback	9		
Playback off timer	9		
Pos	15, 18		
Power save	21		
Programme list search	16		

Specifications

Power Source:	220–240 V AC 50/60 Hz
Power Consumption:	21 W
Power Consumption When in Standby Mode:	Approx. 3 W (When Power save function is activated)

Video Recording System:	2 rotary heads, helical scanning system	
Video Heads:	4 heads	
Audio Heads:	2 heads (Hi-Fi)	
Tape Speed:	SP; 23.39 mm/s	
	LP; 11.7 mm/s	
Tape Format:	S-VHS/VHS tape	
Record/Playback Time:	SP; 240 min with NV-E240	
	LP; 480 min with NV-E240	
	SP; 240 min with NV-SE240	
	LP; 480 min with NV-SE240	
FF/REW Time:	approx. 60 s with NV-E180	
VIDEO		
Television System:	CCIR; 625 lines, 50 fields, PAL colour signal	
Modulation System:	Luminance; FM azimuth recording	
	Colour signal; converted subcarrier phase shift recording	
Input Level:	1.0 Vp-p,	75 ohm, terminated
Output Level:	1.0 Vp-p,	75 ohm, terminated
RF Modulated;	UHF channel (21–69),	75 ohm
AUDIO		
Input Level:	–6 dBV,	more than 10 kohm
Output Level:	–6 dBV,	less than 1 kohm
Video Horizontal Resolution:	Colour; more than 240 lines (VHS/SP)	
	Colour; more than 400 lines (S-VHS/S-VHS-ET/S-Video socket) (SP)	
Signal-to-Noise Ratio:	Video; more than 45 dB (S-VHS/SP)	
Dynamic Range:	Audio; more than 90 dB (Hi-Fi audio track)	
Audio Frequency Response:	20 Hz–20 kHz/Hi-Fi	
Operating Temperature:	5°C–40°C	
Operating Humidity:	35%–80%	
Weight:	3.5 kg	
Dimensions:	430 (W) × 87 (H) × 282 (D) mm	

Weight and dimensions shown are approximate. Specifications are subject to change without notice.

<http://www.panasonic.co.jp/global/>