

**PRODUCT SPECIFICATION
FOR
APPROVAL**

Model Name	NV140FHM-N32
Description	14.0 FHD color TFT-LCD with LED backlight / Glare surface
Prepared by	Eric Dai/ Engineer
Checked by	Jonathan Jia/ Manager
Approved by	Charles Hou/ Dept. Manager

Customer	Lenovo
-----------------	--------

_____	_____
_____	_____
_____	_____



PROPRIETARY NOTE

THIS SPECIFICATION IS THE PROPERTY OF BOE BJ AND SHALL NOT BE REPRODUCED OR COPIED WITHOUT THE WRITTEN PERMISSION OF BOE BJ AND MUST BE RETURNED TO BOE BJ UPON ITS REQUEST

SPEC. NUMBER

PRODUCT GROUP

Rev.

ISSUE DATE

PAGE

TFT-LCD

P0

2014.09.25

2 OF 32

NV140FHM-N32

Preliminary Product Specification Rev. P0

For Lenovo

BEIJING BOE DISPLAY TECHNOLOGY



PRODUCT GROUP

REV

ISSUE DATE

TFT- LCD PRODUCT

P0

2014.09.25

SPEC. NUMBER

SPEC. TITLE

NV140FHM-N32 Preliminary Product Specification

PAGE

3 OF 32

REVISION HISTORY

REV.	ECN No.	DESCRIPTION OF CHANGES	DATE	PREPARED
P0	-	Initial Release	2014.09.25	周波

Contents

No.	Items	Page
1.0	General Description	5
2.0	Absolute Maximum ratings	7
3.0	Electrical specifications.	8
4.0	Optical specifications.	11
5.0	Interface Connection	16
6.0	Signal Timing Specification	18
7.0	Input Signals, Display Colors & Gray Scale of Colors	22
8.0	Power Sequence	22
9.0	Connector description	23
10.0	Mechanical Characteristics	24
11.0	Reliability Test	25
12.0	Handling & Cautions.	25
13.0	Label	26
14.0	Packing information	28
15.0	Mechanical Outline Dimension	29
16.0	EDID Table	31

1.0 GENERAL DESCRIPTION

1.1 Introduction

NV140FHM-N32 is a color active matrix TFT LCD module using amorphous silicon TFT's (Thin Film Transistors) as an active switching devices. This module has a 14.0 inch diagonally measured active area with FHD resolutions (1920 horizontal by 1080 vertical pixel array). Each pixel is divided into RED, GREEN, BLUE dots which are arranged in vertical Stripe and this module can display 262,144 colors. The TFT-LCD panel used for this module is a low reflection and higher color type. Therefore, this module is suitable for Notebook PC. The LED Driver for back-light driving is built in this model.

All input signals are eDP interface compatible.

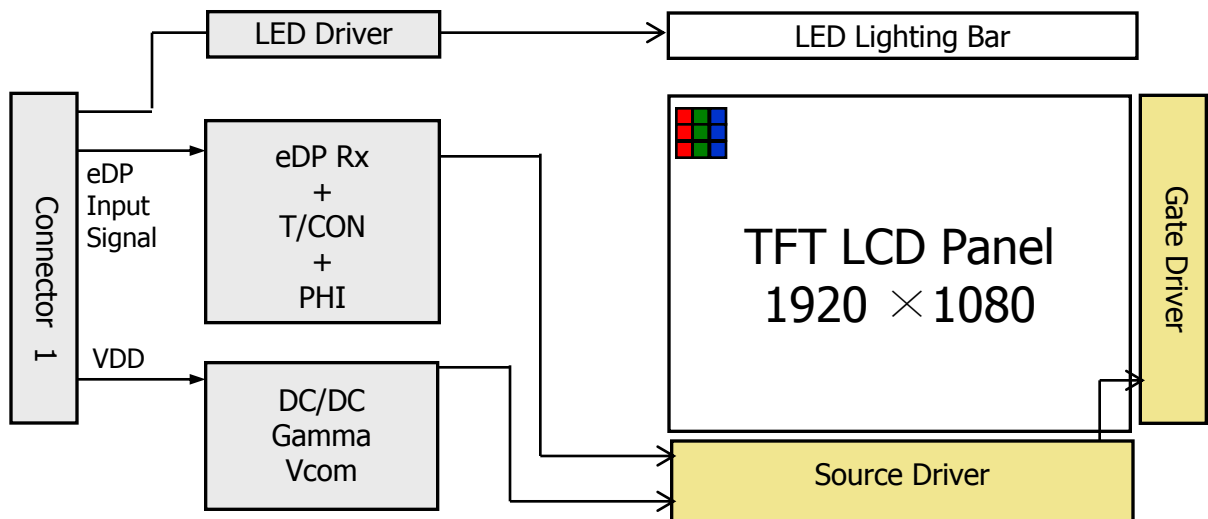

1.2 Features

- 2 lane eDP1.2 Interface with 2.7Gbps Link Rates
- Thin and light weight
- 6-bit color depth, display 262K colors
- Single LED Lighting Bar. (Down side/Horizontal Direction)
- Data enable signal mode
- Side Mounting Frame
- Green Product (RoHS & Halogen free product)
- On board LED Driving circuit
- Low driving voltage and low power consumption
- On board EDID chip

1.3 Application

- Notebook PC (Wide type)

1.4 General Specification

The followings are general specifications at the model NV140FHM-N32 . (listed in Table 1.)

<Table 1. General Specifications>

Parameter	Specification	Unit	Remarks
Active area	309.312(H) × 173.988(V)	mm	
Number of pixels	1920 (H) × 1080 (V)	pixels	
Pixel pitch	0.1611(H) × 0.1611 (V)	mm	
Pixel arrangement	RGB Vertical stripe		
Display colors	262K	colors	
Display mode	Normally Black		
Dimensional outline	320.4 ± 0.5 (H) × 198.6 ± 0.5 (V) × 3.0 max	mm	
Weight	290 (max)	g	
Surface treatment	Glare/ Hard coating 3H		
Back-light	Down edge side, 1-LED Lighting Bar type		Note 1
Power consumption	P_D : 0.9 (max)	W	Note 2
	P_{BL} : 3.2 (max)	W	
	P_{total} : 4.1 (max)	W	

Notes : 1. LED Lighting Bar (40*LED Array)

Notes: 2. Maximum Measurement Condition :Mosaic Pattern

2.0 ABSOLUTE MAXIMUM RATINGS

The followings are maximum values which, if exceed, may cause faulty operation or damage to the unit. The operational and non-operational maximum voltage and current values are listed in Table 2.

< Table 2. Absolute Maximum Ratings >

Ta=25+/-2°C

Parameter	Symbol	Min.	Max.	Unit	Remarks
Power Supply Voltage	V _{DD}	-0.3	4.0	V	Note 1
Logic Supply Voltage	V _{IN}	V _{SS} -0.3	V _{DD} +0.3	V	
Operating Temperature	T _{OP}	0	+50	°C	Note 2
Storage Temperature	T _{ST}	-20	+60	°C	

- Notes : 1. Permanent damage to the device may occur if maximum values are exceeded functional operation should be restricted to the condition described under normal operating conditions.
2. Temperature and relative humidity range are shown in the figure below.
 95 % RH Max. (40 °C ≥ Ta)
 Maximum wet - bulb temperature at 39 °C or less. (Ta > 40 °C) No condensation.

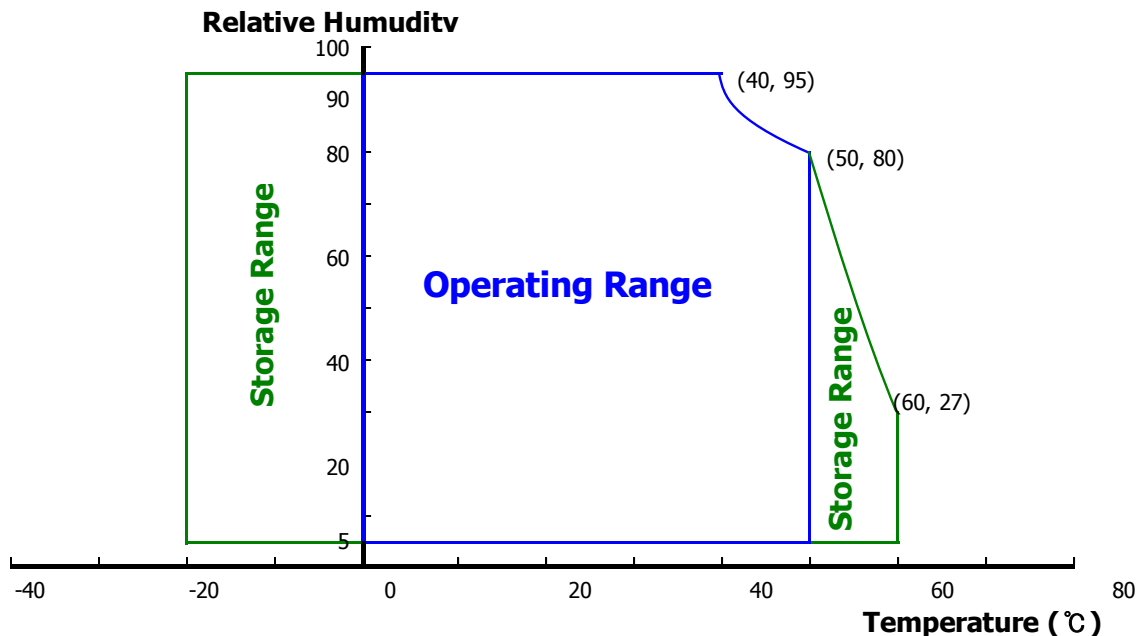

3.0 ELECTRICAL SPECIFICATIONS

3.1 Electrical Specifications

< Table 3. Electrical specifications >

Ta=25+/-2°C

Parameter		Min.	Typ.	Max.	Unit	Remarks
Power Supply Voltage	V _{DD}	3.0	3.3	3.6	V	Note 1
Permissible Input Ripple Voltage	V _{RF}	-	-	100	mV	At V _{DD} = 3.3V
Power Supply Current	I _{DD}	-	210	-	mA	Note 1
Positive-going Input Threshold Voltage	V _{IT+}	-	-	100	mV	V _{cm} = 1.2V typ.
Negative-going Input Threshold Voltage	V _{IT-}	-100	-	-	mV	
Differential Input Voltage	V _{ID}	200	-	600	mV	
Power Consumption	P _D	-	-	0.9	W	Note 1
	P _{BL}	-	-	3.2	W	Note 2
	P _{total}	-	-	4.1	W	

Notes : 1. The supply voltage is measured and specified at the interface connector of LCM.
The current draw and power consumption specified is for 3.3V at 25°C.

Max : Mosaic Pattern

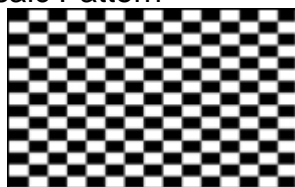

2. Calculated value for reference (V_{LED} × I_{LED})

3.0 ELECTRICAL SPECIFICATIONS

3.2 Backlight Unit

< Table 4. LED Driving guideline specifications >

Ta=25+/-2°C

Parameter		Min.	Typ.	Max.	Unit	Remarks	
LED Forward Voltage		V_F	-	-	3.0	V	-
LED Forward Current		I_F	-	23		mA	-
LED Power Consumption		P_{LED}		-	3.2	W	Note 1
LED Life-Time		N/A	15,000	-	-	Hour	$I_F = 23mA$
Power supply voltage for LED Driver		V_{LED}	6	12	21	V	
EN Control Level	Backlight on		2.2		5.0	V	
	Backlight off		0		0.6	V	
PWM Control Level	PWM High Level		2.2		5.0	V	
	PWM Low Level		0		0.6	V	
PWM Control Frequency		F_{PWM}	180	-	10,000	Hz	
Duty Ratio		-	1	-	100	%	

Notes : 1. Power supply voltage 12V for LED Driver, Driver efficiency 87%,

Calculator Value for reference $I_F \times V_F \times 40 / 0.87 = P_{LED}$

2. The LED Life-time define as the estimated time to 50% degradation of initial luminous.

3.3 LED structure

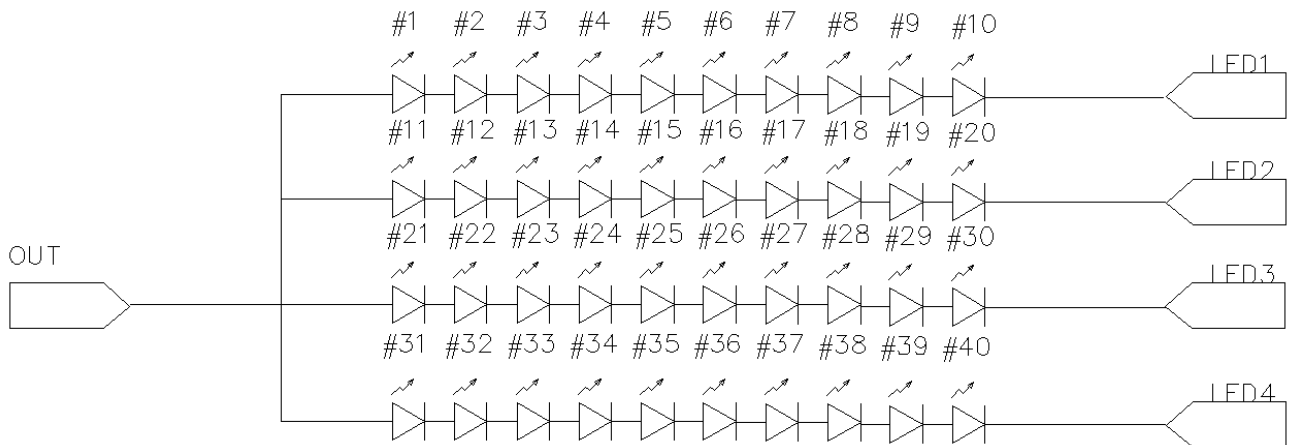

4.0 OPTICAL SPECIFICATION

4.1 Overview

The test of Optical specifications shall be measured in a dark room (ambient luminance ≤ 1 lux and temperature = $25 \pm 2^\circ\text{C}$) with the equipment of Luminance meter system (Goniometer system and TOPCON BM-5) and test unit shall be located at an approximate distance 50cm from the LCD surface at a viewing angle of θ and Φ equal to 0° . We refer to $\theta\emptyset=0$ ($=\theta_3$) as the 3 o'clock direction (the "right"), $\theta\emptyset=90$ ($=\theta_{12}$) as the 12 o'clock direction ("upward"), $\theta\emptyset=180$ ($=\theta_9$) as the 9 o'clock direction ("left") and $\theta\emptyset=270$ ($=\theta_6$) as the 6 o'clock direction ("bottom"). While scanning θ and/or \emptyset , the center of the measuring spot on the Display surface shall stay fixed. The backlight should be operating for 30 minutes prior to measurement. VDD shall be $3.3 \pm 0.3\text{V}$ at 25°C . Optimum viewing angle direction is 6 'clock.

4.2 Optical Specifications

<Table 5. Optical Specifications>

Parameter		Symbol	Condition	Min.	Typ.	Max.	Unit	Remark
Viewing Angle range	Horizontal	Θ_3	CR > 10		85	-	Deg.	Note 1
		Θ_9			85	-	Deg.	
	Vertical	Θ_{12}			85	-	Deg.	
		Θ_6			85	-	Deg.	
Luminance Contrast ratio		CR	$\Theta = 0^\circ$	600	800			Note 2
Luminance of White	5 Points	Y_w	$\Theta = 0^\circ$ $I_{LED} = 20\text{mA}$	213	250	-	cd/m^2	Note 3
White Luminance uniformity	5 Points	ΔY_5		80	-	-		Note 4
	13 Points	ΔY_{13}		65	-	-		
White Chromaticity		X_w	$\Theta = 0^\circ$	0.283	0.313	0.343		Note 5
		Y_w		0.299	0.329	0.359		
Reproduction of color	Red	X_R	$\Theta = 0^\circ$	-0.03	TBD	+0.03		
		Y_R			TBD			
	Green	X_G			TBD			
		Y_G			TBD			
	Blue	X_B			TBD			
		Y_B			TBD			
Response Time (Rising + Falling)		T_{RT}	$T_a = 25^\circ\text{C}$ $\Theta = 0^\circ$	-	30	35	ms	Note 6
Cross Talk		CT	$\Theta = 0^\circ$	-	-	2.0	%	Note 7

Notes :

1. Viewing angle is the angle at which the contrast ratio is greater than 10. The viewing angles are determined for the horizontal or 3, 9 o'clock direction and the vertical or 6, 12 o'clock direction with respect to the optical axis which is normal to the LCD surface (see FIGURE 1).

2. Contrast measurements shall be made at viewing angle of $\Theta = 0$ and at the center of the LCD surface. Luminance shall be measured with all pixels in the view field set first to white, then to the dark (black) state .

(see FIGURE 1) Luminance Contrast Ratio (CR) is defined mathematically.

$$CR = \frac{\text{Luminance when displaying a white raster}}{\text{Luminance when displaying a black raster}}$$

3. Center Luminance of white is defined as luminance values of 5 point average across the LCD surface. Luminance shall be measured with all pixels in the view field set first to white. This measurement shall be taken at the locations shown in FIGURE 2 for a total of the measurements per display.

4. The White luminance uniformity on LCD surface is then expressed as : $\Delta Y = \text{Minimum Luminance of 5(or 13) points} / \text{Maximum Luminance of 5(or 13) points}$.
(see FIGURE 2 and FIGURE 3).

5. The color chromaticity coordinates specified in Table 5 shall be calculated from the spectral data measured with all pixels first in red, green, blue and white. Measurements shall be made at the center of the panel.

6. The electro-optical response time measurements shall be made as FIGURE 4 by switching the "data" input signal ON and OFF. The times needed for the luminance to change from 10% to 90% is T_r , and 90% to 10% is T_d .

7. Cross-Talk of one area of the LCD surface by another shall be measured by comparing the luminance (Y_A) of a 25mm diameter area, with all display pixels set to a gray level, to the luminance (Y_B) of that same area when any adjacent area is driven dark.
(See FIGURE 5).

4.3 Optical measurements

Figure 1. Measurement Set Up

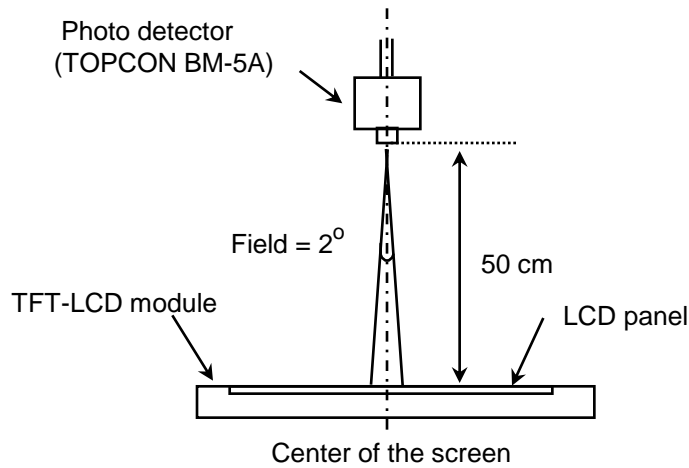

Optical characteristics measurement setup

Figure 2. White Luminance and Uniformity Measurement Locations (5 points)

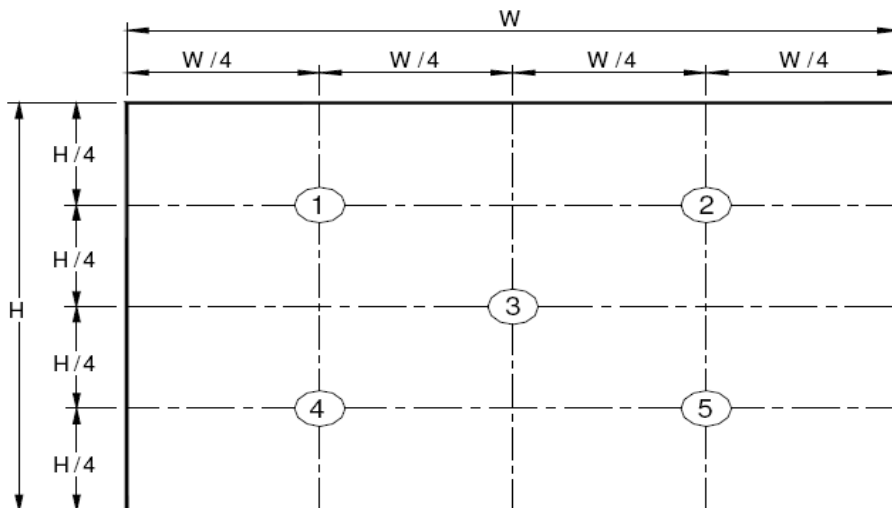

Center Luminance of white is defined as luminance values of center 5 points across the LCD surface. Luminance shall be measured with all pixels in the view field set first to white. This measurement shall be taken at the locations shown in FIGURE 2 for a total of the measurements per display.

Figure 3. Uniformity Measurement Locations (13 points)

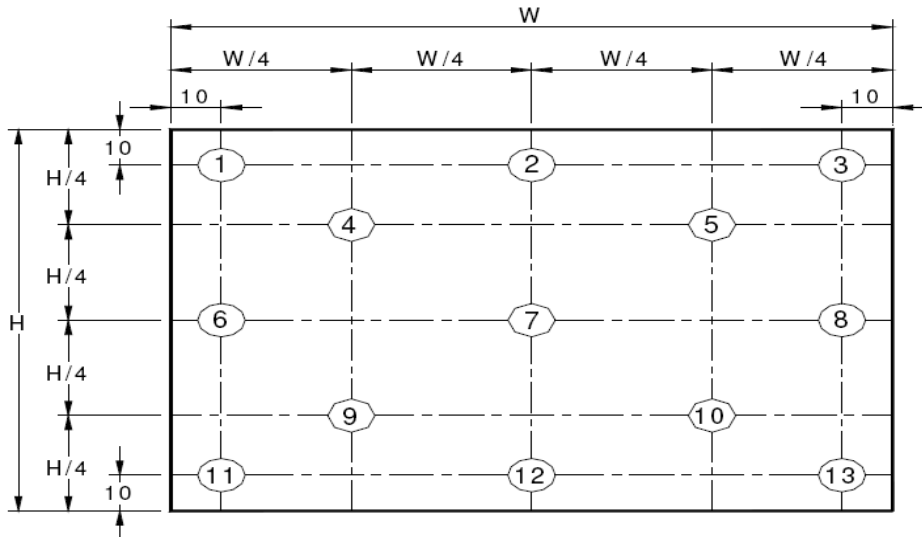

The White luminance uniformity on LCD surface is then expressed as : $\Delta Y_5 = \text{Minimum Luminance of five points} / \text{Maximum Luminance of five points}$ (see FIGURE 2) , $\Delta Y_{13} = \text{Minimum Luminance of 13 points} / \text{Maximum Luminance of 13 points}$ (see FIGURE 3).

Figure 4. Response Time Testing

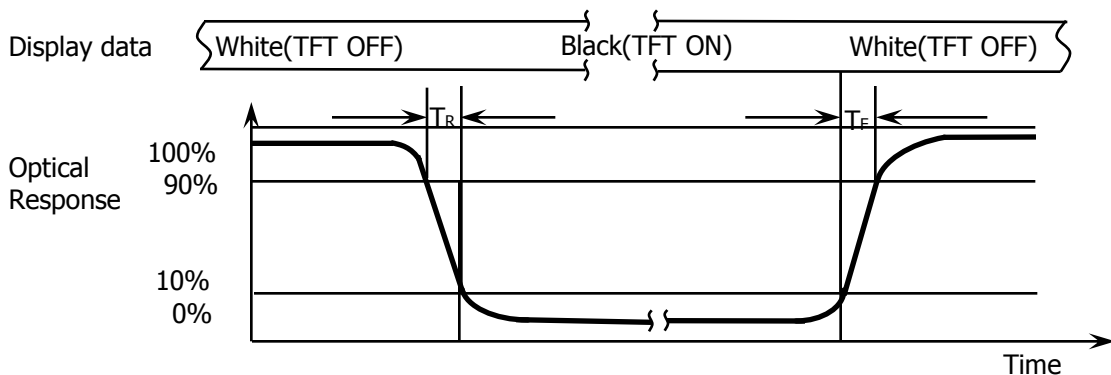

The electro-optical response time measurements shall be made as shown in FIGURE 4 by switching the “data” input signal ON and OFF. The times needed for the luminance to change from 10% to 90% is T_d and 90% to 10% is T_r .

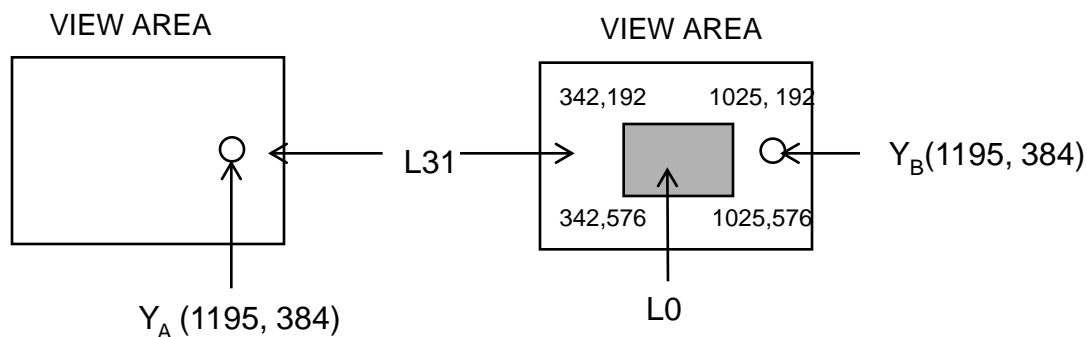
Figure 5. Cross Modulation Test Description

$$\text{Cross-Talk (\%)} = \left| \frac{Y_B - Y_A}{Y_A} \right| \times 100$$

Where:

Y_A = Initial luminance of measured area (cd/m^2)

Y_B = Subsequent luminance of measured area (cd/m^2)

The location measured will be exactly the same in both patterns

Cross-Talk of one area of the LCD surface by another shall be measured by comparing the luminance (Y_A) of a 25mm diameter area, with all display pixels set to a gray level, to the luminance (Y_B) of that same area when any adjacent area is driven dark (Refer to FIGURE 5).

5.0 INTERFACE CONNECTION.

5.1 Electrical Interface Connection

The electronics interface connector is UJU IS050-L30B-C10.

The connector interface pin assignments are listed in Table 6.

<Table 6. Pin Assignments for the Interface Connector>

Terminal	Symbol	Functions
Pin No.	Symbol	Description
1	NC	No Connection
2	H_GND	Ground
3	LANE1_N	eDP RX channel 1 negative
4	LANE1_P	eDP RX channel 1 positive
5	H_GND	Ground
6	LANE0_N	eDP RX channel 0 negative
7	LANE0_P	eDP RX channel 0 positive
8	H_GND	Ground
9	AUX_CH_P	eDP AUX CH positive
10	AUX_CH_N	eDP AUX CH negative
11	H_GND	Ground
12	LCD_VCC	Power Supply, 3.3V (typ.)
13	LCD_VCC	Power Supply, 3.3V (typ.)
14	NC	No Connection
15	H_GND	Ground
16	H_GND	Ground
17	HPD	Hot plug detect output
18	BL_GND	LED Ground
19	BL_GND	LED Ground
20	BL_GND	LED Ground
21	BL_GND	LED Ground
22	BL_ENABLE	LED enable pin(+3.3V Input)
23	BL_PWM	System PWM Signal Input
24	H-Sync	H-Sync
25	NC	No Connection
26	BL_POWER	LED Power Supply 5V-21V
27	BL_POWER	LED Power Supply 5V-21V
28	BL_POWER	LED Power Supply 5V-21V
29	BL_POWER	LED Power Supply 5V-21V
30	COLOR_ENABLE	COLOR_ENABLE

5.2. eDP Interface

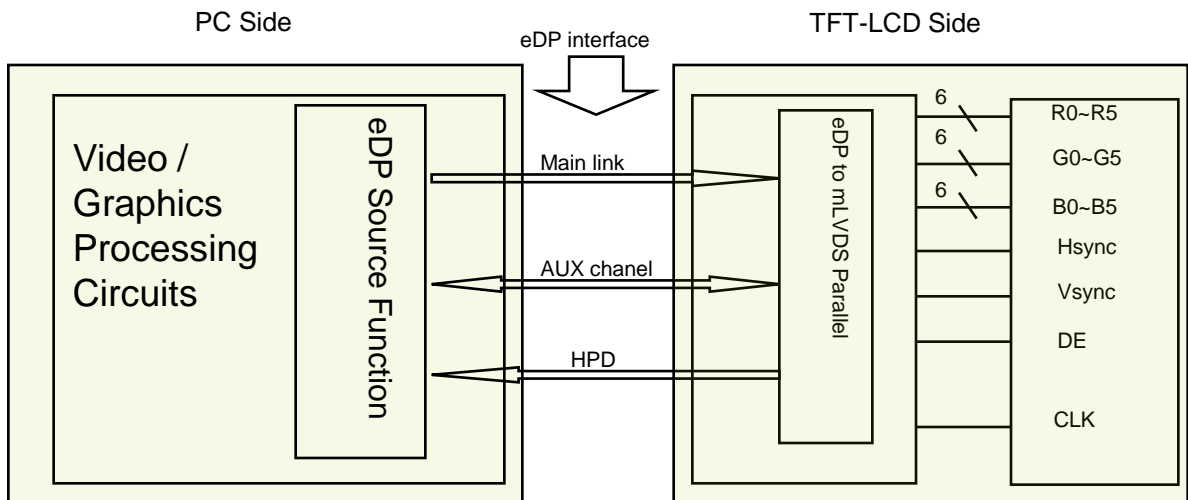

Note. Transmitter : Parade DP501 or equivalent.
Transmitter is not contained in Module.

5.3. eDP Input signal

Lane0	
R0-5:0	G0-5:4
G0-3:0	B0-5:2
B0-1:0	R1-5:0
G1-5:0	B1-5:4
B1-3:0	R2-5:2
R2-1:0	G2-5:0
B2-5:0	R3-5:4
R3-3:0	G3-5:2
G3-1:0	B3-5:0

5.4 Data Input Format

<Table 6. Pin Assignments for the Interface Connector>

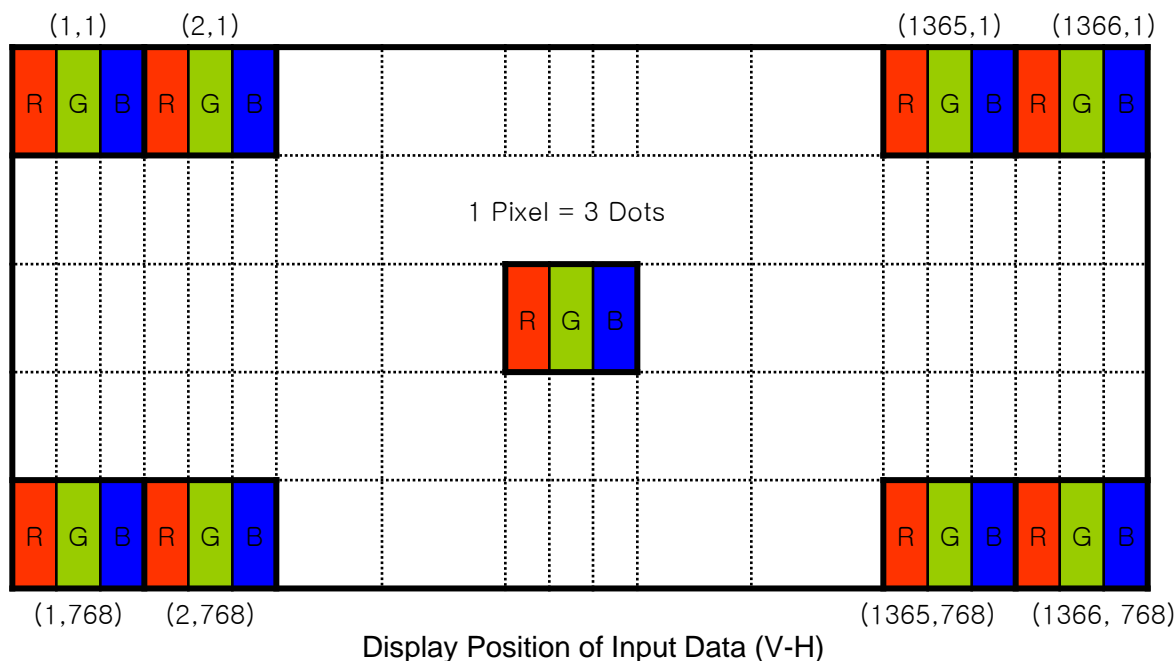

5.5 Back-light & LCM Interface Connection

Interface Connector: MSK24022P10

<Table 7. Pin Assignments for the BLU & LCM Connector>

Pin No.	Symbol	Description	Pin No.	Symbol	Description
1	LED1	LED cathode connection	6	LED6	LED cathode connection
2	LED2	LED cathode connection	7	GND	Ground
3	LED3	LED cathode connection	8	NC	No Connection
4	LED4	LED cathode connection	9	Vout	LED anode connection
5	LED5	LED cathode connection	10	Vout	LED anode connection

6.0 SIGNAL TIMING SPECIFICATION

6.1 The NV140FHM-N32 is operated by the DE only.

Item		Symbols	Min	Typ	Max	Unit
Clock	Frequency	$1/T_c$	100	148.5	160	MHz
	High Time	T_{ch}	-	$4/7T_c$	-	Tc
	Low Time	T_{cl}	-	$4/7T_c$	-	Tc
Frame Period		T_v	1112	1125	1238	lines
			40	60	66	Hz
			25	16.67	15.15	ms
Vertical Display Period		T_{vd}	-	1080	-	lines
One line Scanning Period		T_h	2080	2200	2400	clocks
Horizontal Display Period		T_{hd}	-	1920	-	clocks

Note : This module can support low frame refresh rate 50Hz&40Hz.

6.2 eDP Rx Interface Timing Parameter

The specification of the eDP Rx interface timing parameter is shown in Table 8.

<Table 8. eDP Rx Interface Timing Specification>

Item	Symbol	Min	Typ	Max	Unit	Remark
Spread spectrum clock	SSC		0.5		%	
Differential peak-to-peak input voltage at package pins	VRX-DIFFp-p	100	0	1320	mV	
Rx input DC common mode voltage	VRX_DC_CM	-	GND	-	V	
Differential termination resistance	RRX-DIFF	80	-	100	Ω	
Single-ended termination resistance	RRX-SE	40	-	60	Ω	
Rx short circuit current limit	IRX_SHORT	-	-	20	mA	
Intra-pair skew at Rx package pins (HBR) RX intra-pair skew tolerance at HBR	LRX_SKEW_INTRA_PAIR	-	-	150	ps	

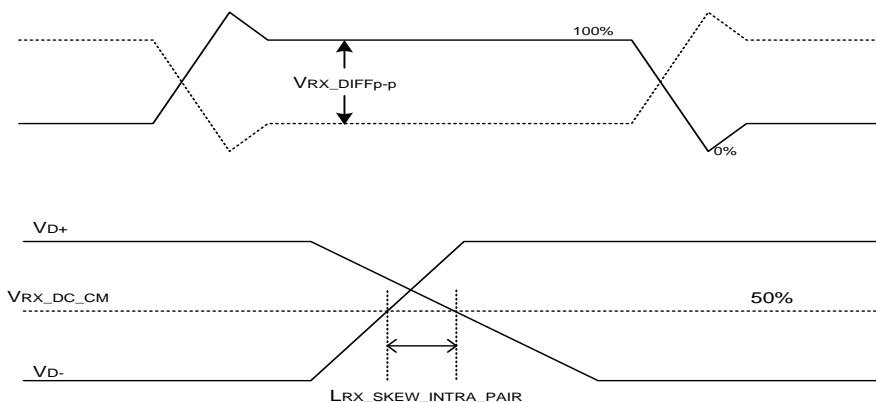

7.0 INPUT SIGNALS, BASIC DISPLAY COLORS & GRAY SCALE OF COLORS

	Colors & Gray scale	Data signal																	
		R0	R1	R2	R3	R4	R5	G0	G1	G2	G3	G4	G5	B0	B1	B2	B3	B4	B5
Basic colors	Black	0	0	0	0	0	0	0	0	0	0	0	0	0	0	0	0	0	0
	Blue	0	0	0	0	0	0	0	0	0	0	0	0	1	1	1	1	1	1
	Green	0	0	0	0	0	0	1	1	1	1	1	1	0	0	0	0	0	0
	Light Blue	0	0	0	0	0	0	1	1	1	1	1	1	1	1	1	1	1	1
	Red	1	1	1	1	1	1	0	0	0	0	0	0	0	0	0	0	0	0
	Purple	1	1	1	1	1	1	0	0	0	0	0	0	1	1	1	1	1	1
	Yellow	1	1	1	1	1	1	1	1	1	1	1	1	0	0	0	0	0	0
White	1	1	1	1	1	1	1	1	1	1	1	1	1	1	1	1	1	1	
Gray scale of Red	Black	0	0	0	0	0	0	0	0	0	0	0	0	0	0	0	0	0	0
	△	1	0	0	0	0	0	0	0	0	0	0	0	0	0	0	0	0	0
	Darker	0	1	0	0	0	0	0	0	0	0	0	0	0	0	0	0	0	0
	△	↑						↑						↑					
	▽	↓						↓						↓					
	Brighter	1	0	1	1	1	1	0	0	0	0	0	0	0	0	0	0	0	0
▽	0	1	1	1	1	1	0	0	0	0	0	0	0	0	0	0	0	0	
Red	1	1	1	1	1	1	0	0	0	0	0	0	0	0	0	0	0	0	
Gray scale of Green	Black	0	0	0	0	0	0	0	0	0	0	0	0	0	0	0	0	0	0
	△	0	0	0	0	0	0	1	0	0	0	0	0	0	0	0	0	0	0
	Darker	0	0	0	0	0	0	0	1	0	0	0	0	0	0	0	0	0	0
	△	↑						↑						↑					
	▽	↓						↓						↓					
	Brighter	0	0	0	0	0	0	1	0	1	1	1	1	0	0	0	0	0	0
▽	0	0	0	0	0	0	0	1	1	1	1	1	0	0	0	0	0	0	
Green	0	0	0	0	0	0	1	1	1	1	1	1	0	0	0	0	0	0	
Gray scale of Blue	Black	0	0	0	0	0	0	0	0	0	0	0	0	0	0	0	0	0	0
	△	0	0	0	0	0	0	0	0	0	0	0	0	1	0	0	0	0	0
	Darker	0	0	0	0	0	0	0	0	0	0	0	0	0	1	0	0	0	0
	△	↑						↓						↑					
	▽	↓						↓						↓					
	Brighter	0	0	0	0	0	0	0	0	0	0	0	0	1	0	1	1	1	1
▽	0	0	0	0	0	0	0	0	0	0	0	0	0	1	1	1	1	1	
Blue	0	0	0	0	0	0	0	0	0	0	0	0	1	1	1	1	1	1	
Gray scale of White & Black	Black	0	0	0	0	0	0	0	0	0	0	0	0	0	0	0	0	0	0
	△	1	0	0	0	0	0	1	0	0	0	0	0	1	0	0	0	0	0
	Darker	0	1	0	0	0	0	0	1	0	0	0	0	0	1	0	0	0	0
	△	↑						↑						↑					
	▽	↓						↓						↓					
	Brighter	1	0	1	1	1	1	1	0	1	1	1	1	1	0	1	1	1	1
▽	0	1	1	1	1	1	0	1	1	1	1	1	0	1	1	1	1	1	
White	1	1	1	1	1	1	1	1	1	1	1	1	1	1	1	1	1	1	

8.0 POWER SEQUENCE

To prevent a latch-up or DC operation of the LCD module, the power on/off sequence shall be as shown in below

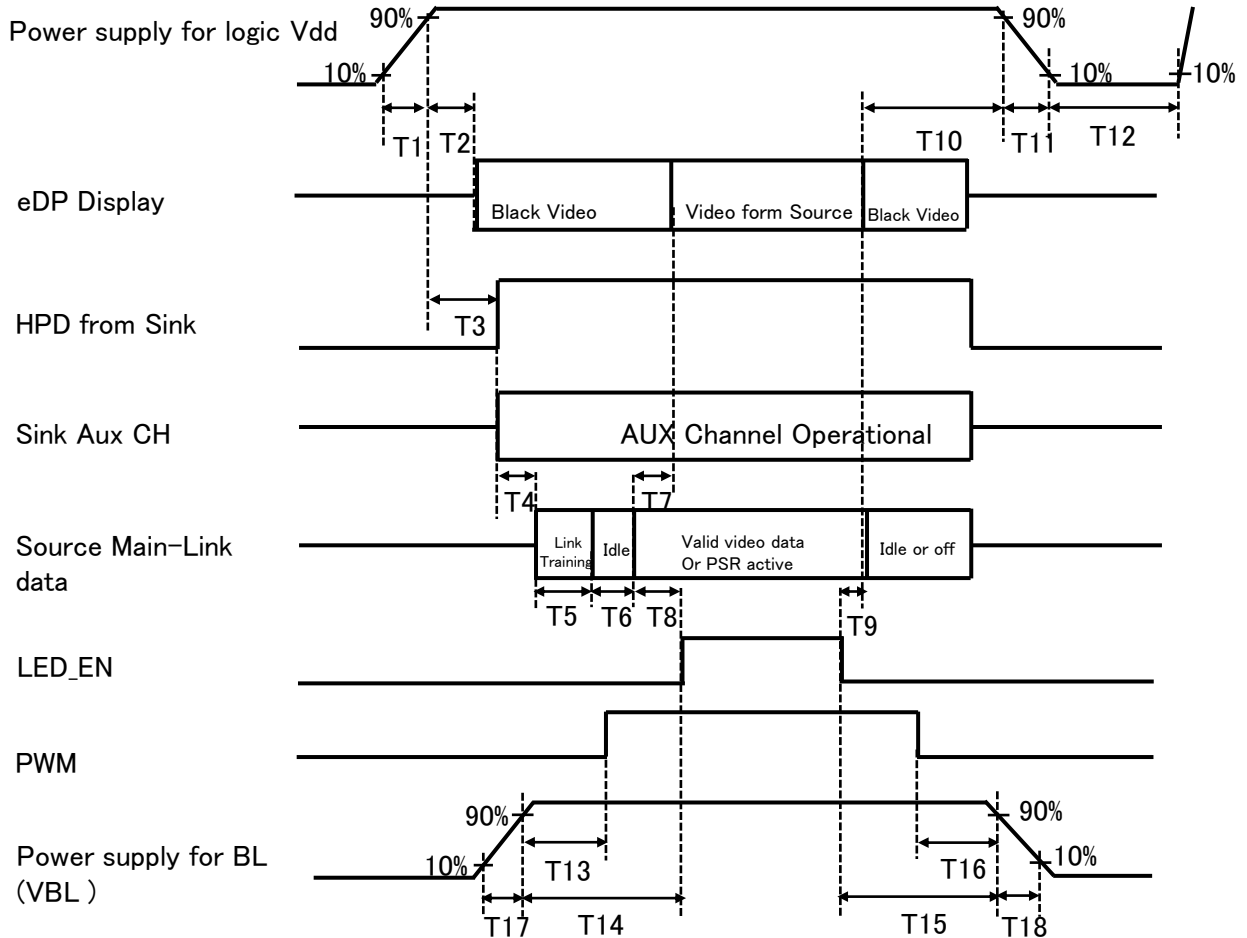

- $0.5\text{ms} \leq T1 \leq 10\text{ms}$
- $0\text{ms} \leq T2 \leq 200\text{ms}$
- $0\text{ms} \leq T3 \leq 200\text{ms}$
- $10\text{ms} \leq T13$
- $20\text{ms} \leq T14$
- $0.5\text{ms} \leq T17 \leq 20\text{ms}$

- $0\text{ms} \leq T7 \leq 50\text{ms}$
- $0\text{ms} \leq T10 \leq 500\text{ms}$
- $T11 \leq 10\text{ms}$
- $500\text{ms} \leq T12$
- $20\text{ms} \leq T15$
- $10\text{ms} \leq T16$
- $0.5\text{ms} \leq T18 \leq 20\text{ms}$

Notes:

1. When the power supply VDD is 0V, keep the level of input signals on the low or keep high impedance.
2. Do not keep the interface signal high impedance when signal invalid period.
3. Backlight power must be turn on after power for logic and interface signal is valid.

9.0 Connector Description

Physical interface is described as for the connector on LCM.

These connectors are capable of accommodating the following signals and will be following components.

9.1 TFT LCD Module

Connector Name /Description	For Signal Connector
Manufacturer	UJU
Type/ Part Number	IS050-L30B-C10
Mating housing/ Part Number	I-PEX 20454-030T or Compatible

10.0 MECHANICAL CHARACTERISTICS

10.1 Dimensional Requirements

FIGURE 6 shows mechanical outlines for the model NV140FHM-N32. Other parameters are shown in Table 9.

<Table 9. Dimensional Parameters>

Parameter	Specification	Unit
Active Area	309.312 (H) × 173.988 (V)	
Number of pixels	1920 (H) X 1080 (V) (1 pixel = R + G + B dots)	
Pixel pitch	0.1611 (H) X 0.1611 (V)	
Pixel arrangement	RGB Vertical stripe	
Display colors	262K	
Display mode	Normally Black	
Dimensional outline	320.4 ± 0.5*198.6 ± 0.5*3.0max	mm
Weight	290 (max)	gram
Back Light	Connector : MSK24022P10	
	LED, Horizontal-LED Array type	

10.2 Mounting

See FIGURE 6.

10.3 Glare and Polarizer Hardness.

The surface of the LCD has an glare coating to maximize readability and hard coating to reduce scratching.

10.4 Light Leakage

There shall not be visible light from the back-lighting system around the edges of the screen as seen from a distance 50cm from the screen with an overhead light level of 350lux.

11.0 RELIABILITY TEST

The Reliability test items and its conditions are shown in below.

<Table 10. Reliability test>

No	Test Items	Conditions
1	High temperature storage test	Ta = 60 °C, 240 hrs
2	Low temperature storage test	Ta = -20 °C, 240 hrs
3	High temperature & high humidity operation test	Ta = 50 °C, 80%RH, 240 hrs
4	High temperature operation test	Ta = 50 °C, 240 hrs
5	Low temperature operation test	Ta = 0 °C, 240 hrs
6	Thermal shock	Ta = -20 °C ↔ 60 °C (0.5 hr), 100 cycle
7	Vibration test (non-operating)	1.5G, 10~500Hz, Half Sine X,Y,Z / Sweep rate : 1 hour
8	Shock test (non-operating)	220G, Half Sine Wave 2msec ±X, ±Y, ±Z Once for each direction
9	Electro-static discharge test (non-operating)	Air : 150 pF, 330Ω, 15 KV Contact : 150 pF, 330Ω, 8 KV

12.0 HANDLING & CAUTIONS

(1) Cautions when taking out the module

- Pick the pouch only, when taking out module from a shipping package.

(2) Cautions for handling the module

- As the electrostatic discharges may break the LCD module, handle the LCD module with care. Peel a protection sheet off from the LCD panel surface as slowly as possible.
- As the LCD panel and back - light element are made from fragile glass material, impulse and pressure to the LCD module should be avoided.
- As the surface of the polarizer is very soft and easily scratched, use a soft dry cloth without chemicals for cleaning.
- Do not pull the interface connector in or out while the LCD module is operating.
- Put the module display side down on a flat horizontal plane.
- Handle connectors and cables with care.

(3) Cautions for the operation

- When the module is operating, do not lose CLK, ENAB signals. If any one of these signals is lost, the LCD panel would be damaged.
- Obey the supply voltage sequence. If wrong sequence is applied, the module would be damaged.

BOE	PRODUCT GROUP	REV	ISSUE DATE
	TFT- LCD PRODUCT	P0	2014.09.25
SPEC. NUMBER	SPEC. TITLE	PAGE	
	NV140FHM-N32 Preliminary Product Specification	26 OF 32	

- (4) Cautions for the atmosphere
- Dew drop atmosphere should be avoided.
 - Do not store and/or operate the LCD module in a high temperature and/or humidity atmosphere. Storage in an electro-conductive polymer packing pouch and under relatively low temperature atmosphere is recommended.
- (5) Cautions for the module characteristics
- Do not apply fixed pattern data signal to the LCD module at product aging.
 - Applying fixed pattern for a long time may cause image sticking.
- (6) Other cautions
- Do not disassemble and/or re-assemble LCD module.
 - Do not re-adjust variable resistor or switch etc.
 - When returning the module for repair or etc., Please pack the module not to be broken. We recommend to use the original shipping packages.

13.0 LABEL

(1) Product label

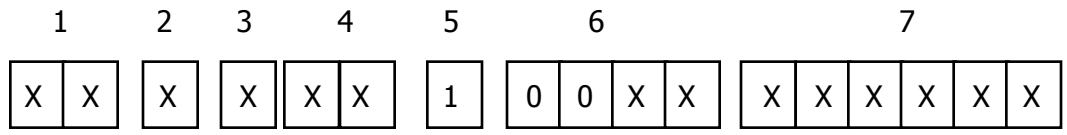

Type designation

No 1. Control Number

No 2. Rank / Grade

No 3. Line classification

No 4. Year (10 : 2010, 11: 2011, ...)

No 5. Month (1, 2, 3, ..., 9, X, Y, Z)

No 6. Product Identification (FG)

No 7. Serial Number

(2) High voltage caution label

	<p>HIGH VOLTAGE CAUTION</p>	<p>COLD CATHODE FLUORESCENT LAMP IN LCD PANEL CONTAINS A SMALL AMOUNT OF MERCURY. PLEASE FOLLOW LOCAL ORDINANCES OR REGULATIONS FOR DISPOSAL.</p>
	<p>RISK OF ELECTRIC SHOCK. DISCONNECT THE ELECTRIC POWER BEFORE SERVICING</p>	

(3) Box label

Label Size: 110 mm (L) × 56 mm (W)

Contents

Model: NV140FHM-N32

Q`ty: Module Q`ty in one box

Serial No.: Box Serial No. See next figure for detail description.

Date: Packing Date

Internal use of Product

		<h2>BOE BEIJING BOE DISPLAY TECHNOLOGY</h2>	
MODEL:	NV140FHM-N32	Q`TY:	38
SERIAL NO:	XXXXXXXXXXXXXX	DATE:	201X/XX/XX
			
<p>XXXX</p>			

SERIA NO	1	2	3	4	5	6	7	8	9	10	11	12	13
code	X	X	X	X	X	X	X	X	X	X	X	X	X
Description	GBN		Grade	Line	Year	Month	Rev	Serial No.					

14.0 PACKING INFORMATION

14.1 Packing order

- Put Pad into the inner box
- Insert EPE block into the Gap between Pad and box

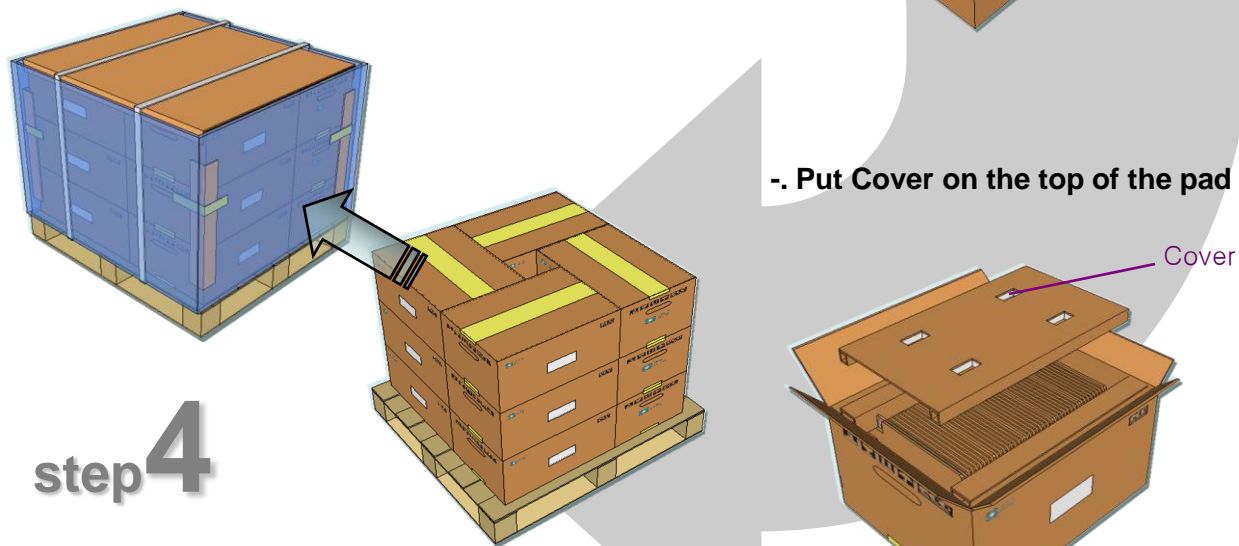
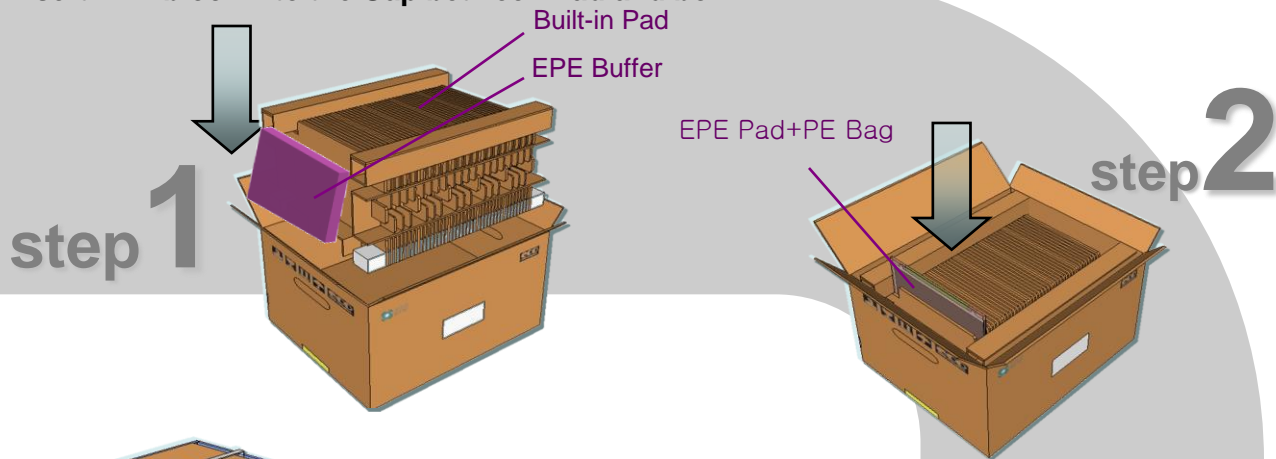

- 12ea Box/Pallet, 456ea MDL/Pallet

14.2 Notes

- Box Dimension: 580mm(W) x 450mm(D) x 280mm(H)
- Package Quantity in one Box: 38pcs
- Total Weight: 15kg

15.0 MECHANICAL OUTLINE DIMENSION

Figure 6. TFT-LCD Module Outline Dimension (Front View)

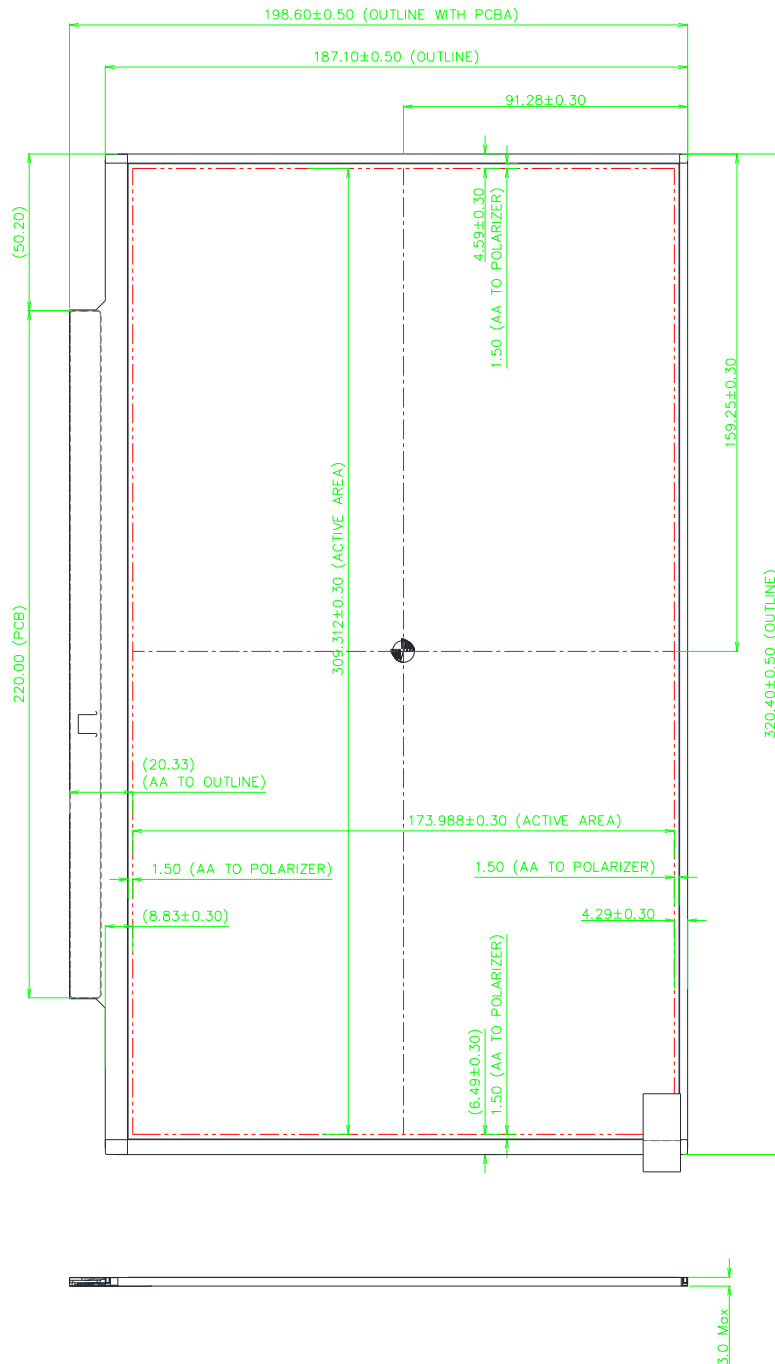

16.0 EDID Table

Address (HEX)	Function	Hex	Dec	crc	Input values.	Notes
00	Header	Hex	Dec	crc	Input values.	Notes
01		00	0		0	
02		FF	255		255	
03		FF	255		255	
04		FF	255		255	
05		FF	255		255	
06		FF	255		255	
07		FF	255		255	
08	ID Manufacturer Name	FF	255		255	
09		00	0		0	
0A	ID Product Code	09	9		BOE	
0B		E5	229			
0C	32-bit serial No.	EF	239			
0D		05	5			
0E		00	0			
0F		00	0			
10	Week of manufacture	00	0			
11	Year of Manufacture	00	0			
12	EDID Structure Ver.	01	1			
13	EDID revision #	17	23			Manufactured in 2013
14	Video input definition	01	1			EDID Ver 1.0
15	Max H image size	04				EDID Rev. 0.4
16	Max V image size	95				digital signal/DP input
17	Display Gamma	1				31 cm (Approx)
18	Feature support					17 cm (Approx)
19	Red/Green low bits					Gamma curve = 2.2
1A	Blue/White low bits					RGB display, Preferred Timming mode/RGB 4:4:4
1B	Red x high bits				-	Red / Green Low Bits
1C	Red y high bits				-	Blue / White Low Bits
1D	Green x high bits	5			0.573	Red (x) = 10010010 (0.573)
1E	Green y high bits	5C			0.36	Red (y) = 01011100 (0.36)
1F	Blue x high bits	56	86		0.339	Green (x) = 01010110 (0.339)
20	Blue y high bits	95	149	599	0.585	Green (y) = 10010101 (0.585)
21	White x high bits	28	40	162	0.159	Blue (x) = 00101000 (0.159)
22	White y high bits	1A	26	106	0.104	Blue (y) = 00011010 (0.104)

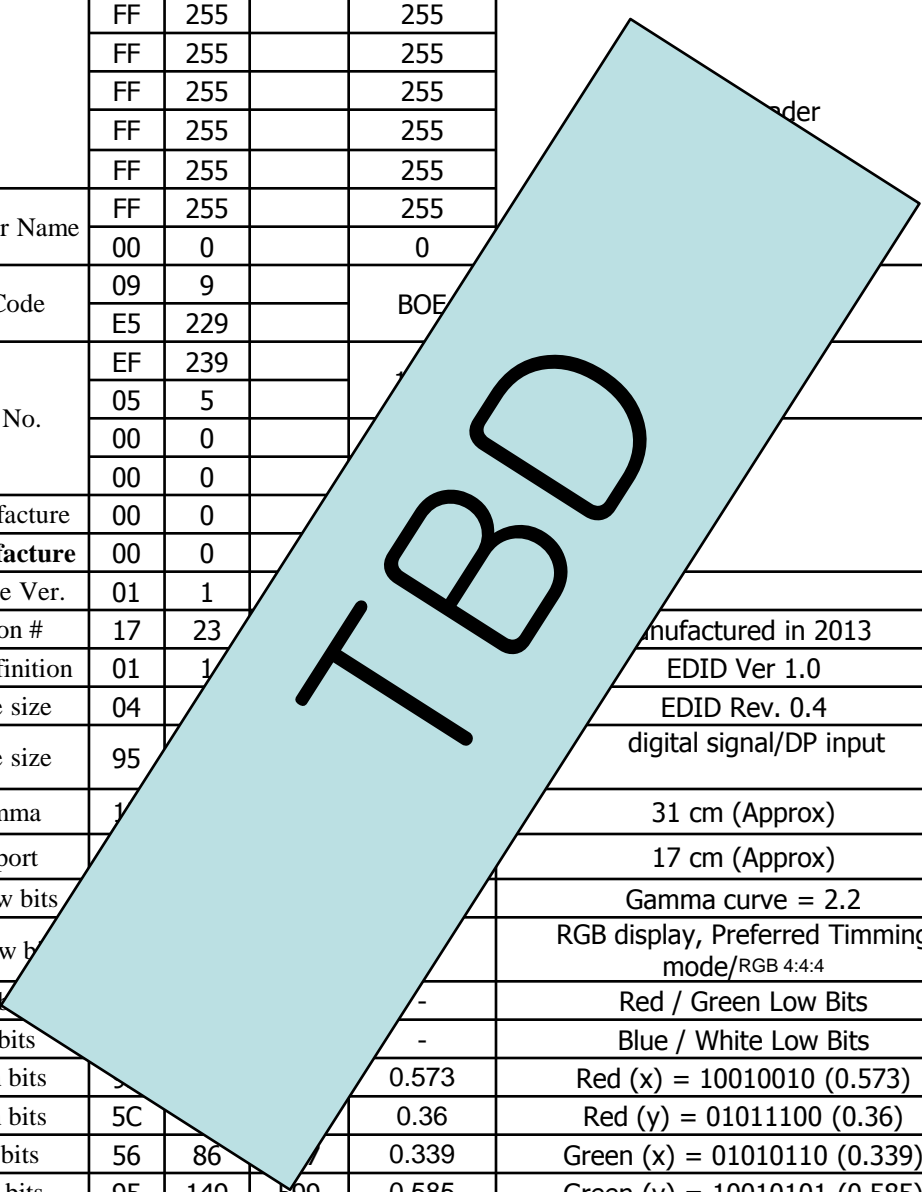

Address (HEX)	Function	Hex	Dec	crc	Input values.	Notes
23	Established timing 1	00	0		-	
24	Established timing 2	00	0		-	
25	Established timing 3	00	0		-	
26	Standard timing #1	01	1			Not Used
27		01	1			
28	Standard timing #2	01	1			Not Used
29		01	1			
2A	Standard timing #3	01	1			Not Used
2B		01	1			
2C	Standard timing #4	01	1			Not Used
2D		01	1			
2E	Standard timing #5	01	1			Not Used
2F		01	1			
30	Standard timing #6	01	1			Not Used
31		01	1			
32	Standard timing #7	01	1			Not Used
33		01	1			
34	Standard timing #8	01	1			Not Used
35		01	1			
36	Detailed timing/monit or descriptor #1	64	100			Hz Main clock
37		1B	27			Active = 1366
38		56	86			Hor Blanking = 119
39		77	119			Hor. Active + 4 bits of Hor. Blanking
3A		50	80			Ver Active = 768
3B		00	0			Ver Blanking = 19
3C		13	19			bits of Ver. Active + 4 bits of Ver. Blanking
3D		30	48			Hor Sync Offset = 48
3E		30	48			H Sync Pulse Width = 32
3F		20	32			V sync Offset = 3 line
40						V Sync Pulse width : 6 line
41						Horizontal Image Size = 309 mm (Low 8 bits)
42						Vertical Image Size = 173 mm (Low 8 bits)
43			AD	173		4 bits of Hor Image Size + 4 bits of Ver Image Size
44		10	16		Hor Border (pixels)	
45		00	0		Vertical Border (Lines)	
46		00	0		Refer to right table	
47		1A	26			

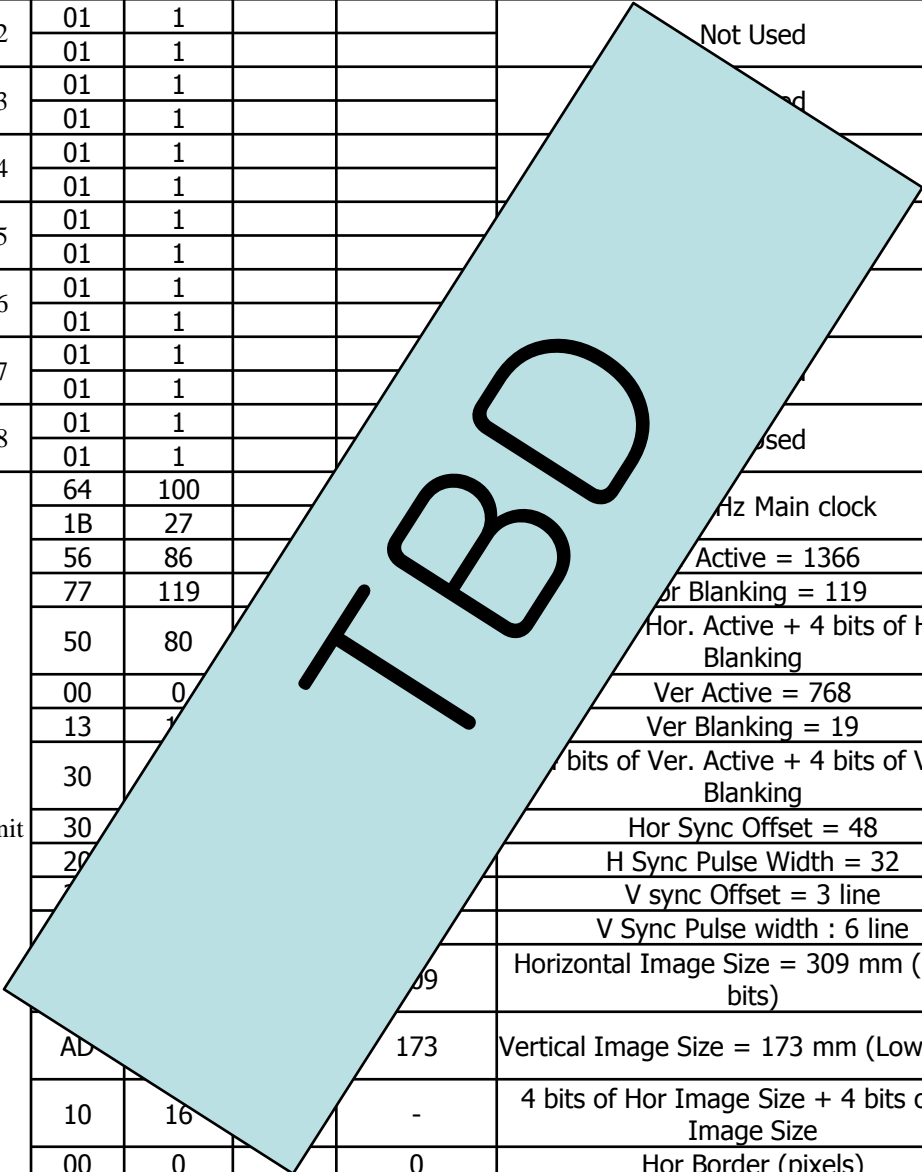

Address (HEX)	Function	Hex	Dec	crc	Input values.	Notes
48	Detailed timing/monit or descriptor #2	70	112		60.0	60MHz Main clock
49		17	23			
4A		56	86		1366	Hor Active = 1366
4B		8C	140		140	Hor Blanking = 140
4C		50	80		-	4 bits of Hor. Active + 4 bits of Hor. Blanking
4D		00	0		768	Hor Active = 768
4E		3E	62		62	Hor Blanking = 62
4F		30	48		-	4 bits of Ver. Blanking
50		30	48		48	
51		20	32		32	
52		36	54		3	
53		00	0		6	Line
54		35	53		3	9 mm (Low 8)
55		AD	173			173 mm (Low 8)
56		10	16			Size + 4 bits of Ver
57		00	0			Edge Size
58	00	0			Border (pixels)	
59	1A	26			al Border (Lines)	
5A	Detailed timing/monit or descriptor #3	00	0			ASCII Data Sting Tag
5B		00	0			
5C		00	0			
5D		FE				
5E		00				
5F		35				
60		38				D/PN:58F5Y
61						
62						
63					0000	EDID:A00
64				H	BOE PN	
65				B		
66	31			1		
67	34			4		
68	33	51		3		
69	30	48		0		
6A	31	49		1		
6B	70	112		60.0		60MHz Main clock

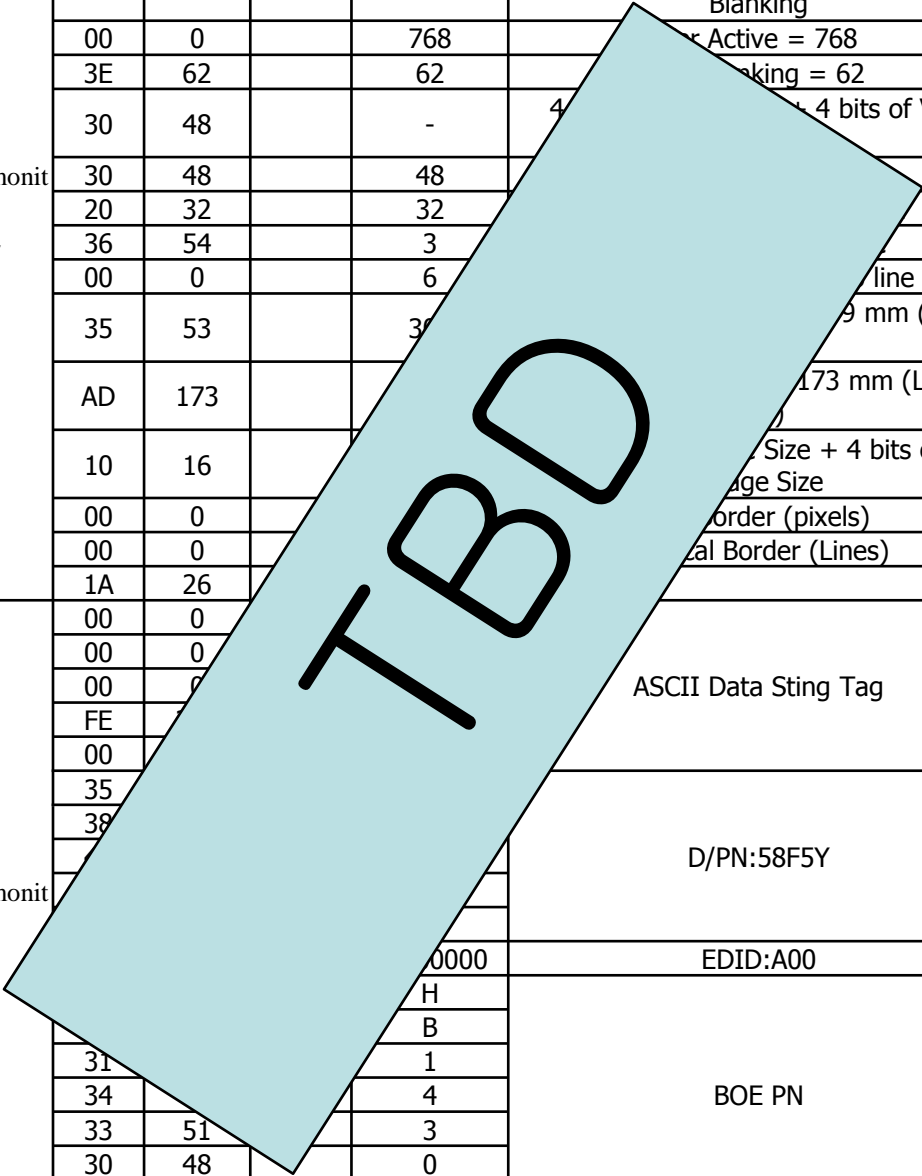

Address (HEX)	Function	Hex	Dec	crc	Input values.	Notes
6C	Detailed timing/monit or descriptor #4	00	0			Product Name Tag (ASCII)
6D		00	0			
6E		00	0			
6F		00	0			
70		00	0			
71		00	0		00000000	h & no FRC
72		41	65		01000001	ne light bar
73		01	1		00000001	
74		94	148		10010100	minance
75		01	1		00000000	B v-stripe
76		10	16		00000000	
77		00	0		00000000	Active Gamma
78		00	0		00000000	ement & no In-Cell anner
79		09	9		00000000	ane edp1.2
7A		01	1		00000000	ilt-In Self Test
7B	0A	10		00000000		
7C	20	32		00000000		
7D	20	32		00000000		
7E	Extension flag	00				
7F	Checksum	23				

