

# Panasonic

Video Cassette Recorder

NV-FJ610 Series

NV-FJ606 Series

NV-FJ604 Series

Operating Instructions

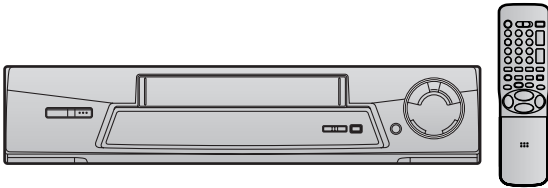

**SHOWVIEW**

**VHS**  
PAL

**SUPER DRIVE**  
MULTI-INTELLIGENT CONTROL II

VQT8539

Before attempting to connect, operate or adjust this product, please read these instructions completely.

# Dear Customer

May we take this opportunity to thank you for purchasing this Panasonic Video Cassette Recorder. We would particularly advise that you carefully study the Operating Instructions before attempting to operate the unit and that you note the listed precautions.

## Contents

<b>Before Use</b>		<b>Advanced Operations</b>	
<b>Controls and Components</b> .....	3	<b>Search Functions</b> .....	17
<b>Preparing the Remote Control</b> .....	4	• To Quickly Find the Beginning of a Desired Programme (VISS=VHS Index Search System) .....	17
<b>Warning and Important Information</b> .....	5	• To Search for a Desired Programme While Checking the Recorded Contents on a Cassette (Intro-Jet Scan) .....	17
<b>Setting the Remote Control to Operate Your TV</b> .....	6	<b>Editing</b> .....	18
		• Assemble Editing .....	18
<b>Connecting and Setting Up</b>		<b>Connecting the VCR to a Decoder/ Connecting the VCR to a Stereo Amplifier</b> .....	19
<b>Connecting the VCR to a TV</b> .....	7	<b>Connecting the VCR to a Satellite Receiver or Digital Receiver</b> .....	20
<b>Playback</b>			
<b>Playback</b> .....	10		
<b>Recording</b>		<b>Various Settings</b>	
<b>Recording</b> .....	11	<b>Tuning and Assigning the TV Stations Available in Your Area to the Programme Positions (Manual Tuning)</b> .....	21
• To Select the Recording Duration and Perform Timer Recording (OTR Recording) .....	12	<b>Restarting the Auto Setup/ Resetting the VCR to the Shipping Condition</b> .....	24
• Linked Timer Recordings with a Digital Receiver .....	12	<b>Setting the VCR's Clock</b> .....	25
		<b>Other Convenient Functions (Various Settings)</b> .....	26
<b>Timer Recording</b>		<b>Helpful Hints</b>	
<b>Timer Recording</b> .....	13	<b>Glossary</b> .....	29
• To Programme with the On Screen Display (OSD) .....	13	<b>Before Requesting Service</b> .....	31
• To Programme with the ShowView Function .....	14	• Adjusting the Playback Picture .....	32
<b>Other Timer Recordings and Convenient Functions</b> .....	15	<b>Cautions</b> .....	33
• To select a Timer-Recorded Programme from the List and Quickly Locate Its Beginning for Automatic Playback (Programme List Search) .....	16	<b>Specifications</b> .....	Back cover

# Controls and Components

Keep this page open as you read through the Operating Instructions. Refer to it for the control and component names and numbers which appear in the text.

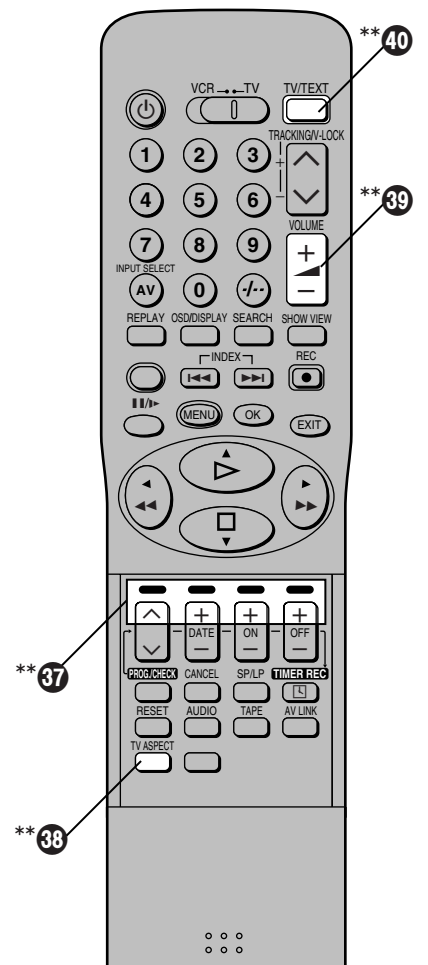
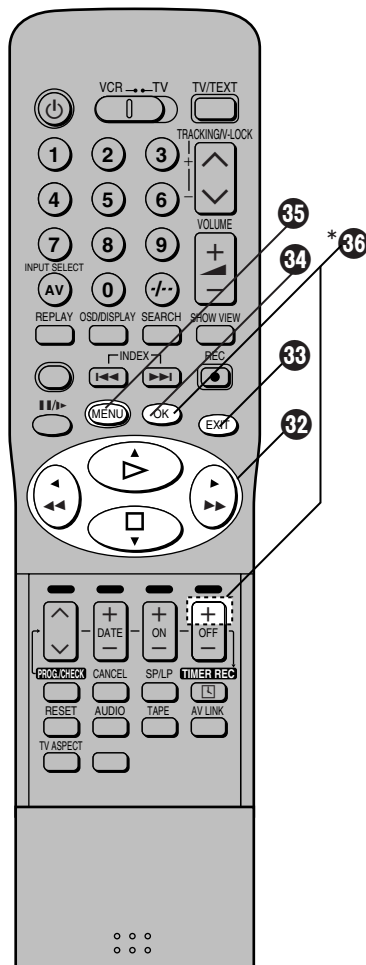
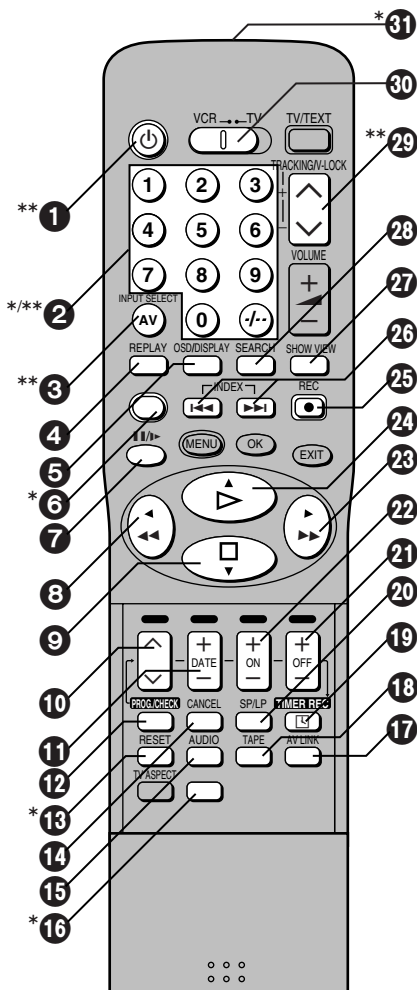
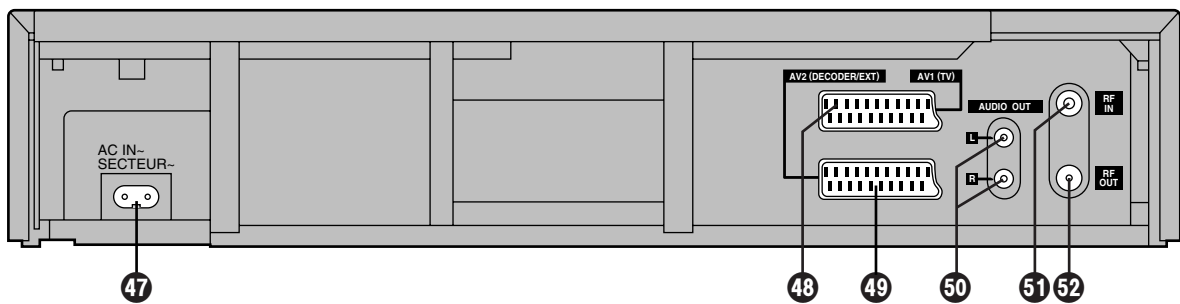
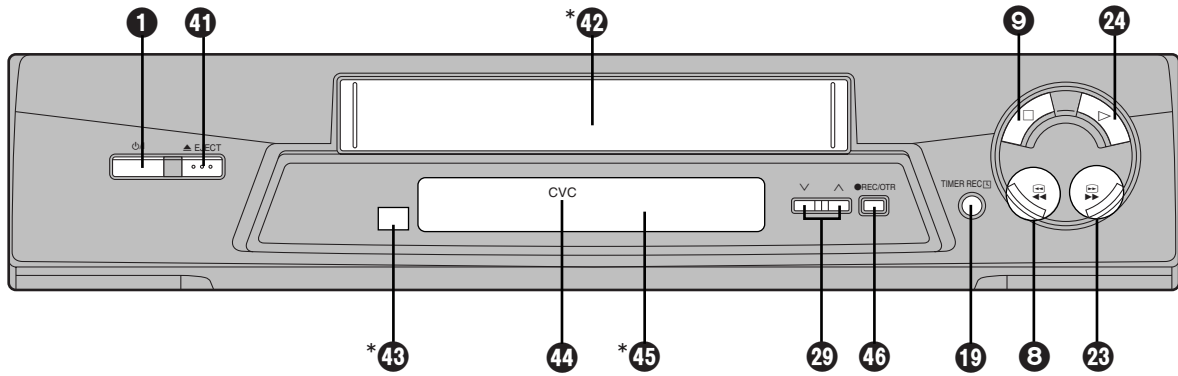

\* See page 4. (VCR Operation)  
 \*\* See page 6. (TV Operation)

## VCR Operation

When you want to operate the VCR, set the VCR/TV switch **30** to "VCR".

### \***2** Numeric buttons

To select the programme positions (1–99) of the VCR.

Example:

9: **9**

19: **1** → **9**

To enter a ShowView number.

To enter numbers for various settings.

### \***6** No function

### \***18** Tape Counter Reset button

To reset the tape counter (elapsed time) to "0:00.00".

- The tape counter is automatically reset to "0:00.00" when a video cassette is inserted.

### \***16** No function

### \***31** Infra-red transmitter

### \***36** Child Lock Function buttons

**(Convenient function to prevent unauthorized use)**

This function deactivates all buttons on the VCR and the remote control. Use this function, when you do not want other people to operate the VCR.

#### To Activate the Child Lock Function:

- 1 Hold down the OK and the OFF (+) buttons **36** simultaneously until the "hold" indication appears in the VCR display.
  - If you press a button while the Child Lock function is on, the "hold" indication appears in the VCR display to inform you that no operation is possible.

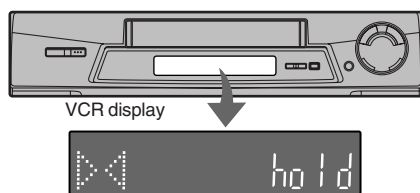

Indication when the Child Lock function is activated

#### To Cancel the Child Lock Function:

- 1 Hold down the OK and the OFF (+) buttons **36** simultaneously until the "hold" indication disappears.
  - If you disconnect the power cable, the Child Lock function is automatically cancelled after the power backup time of approximately 60 minutes has elapsed.

### \***42** Cassette compartment

### \***43** Infra-red Remote Control Receiver window

### \***45** VCR display

## Preparing the Remote Control

### Inserting Remote Control Batteries

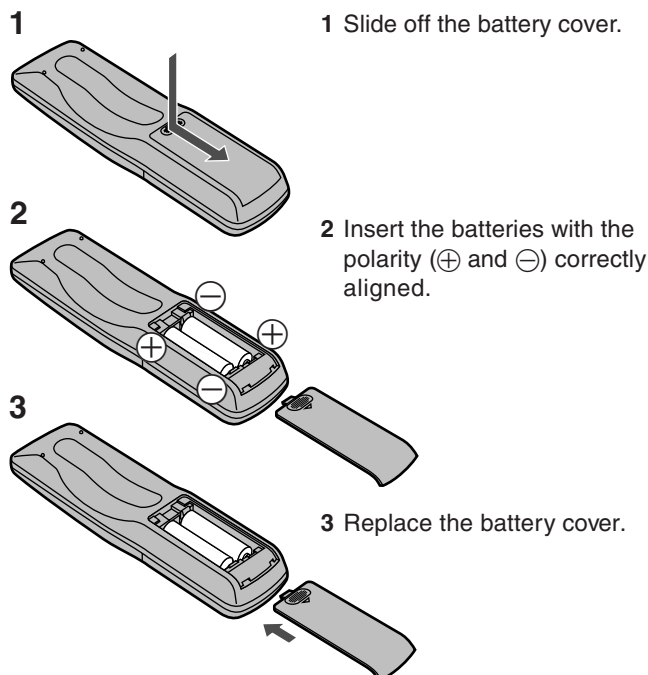

#### Notes for Battery Replacement:

- The service life of the batteries is approximately 1 year. However, it varies considerably depending on the frequency of use.
- When they are exhausted, replace them with two AA, UM3, or R6 size batteries.
- When the batteries are exhausted, remove them immediately and dispose of them correctly.
- Make sure that the batteries are inserted with the polarity (+ and -) correctly aligned.
- Do not mix old battery with new battery.
- Do not mix different battery types, i.e. Alkaline and Manganese.
- Do not use rechargeable (Ni-Cd) batteries.
- Do not heat or short-circuit the batteries.
- When you do not use the remote control for a long time, take out the batteries and store them in a cool, dry place.

### If the Sliding Cover of the Remote Control Becomes Detached

If the sliding cover of the remote control becomes detached accidentally, fit it securely in place by placing it on the top of the remote control at the position shown in the illustration below, and pushing it down until it clicks into position.

- It is not possible to fit the sliding cover in place by pushing or sliding it on from the bottom end of the remote control.

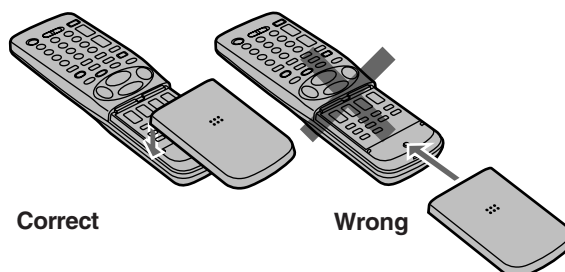

# Warning and Important Information

---

As this equipment gets hot during use, operate it in a well ventilated place; do not install this equipment in a confined space such as a book case or similar unit.

## IMPORTANT

Your attention is drawn to the fact that the recording of pre-recorded tapes or discs or other published or broadcast material may infringe copyright laws.

## WARNING

TO REDUCE THE RISK OF FIRE OR SHOCK HAZARD, DO NOT EXPOSE THIS EQUIPMENT TO RAIN OR MOISTURE.

## FOR YOUR SAFETY

### ■ DO NOT REMOVE OUTER COVER.

To prevent electric shock, do not remove cover. There are no user serviceable parts inside. Refer all servicing to qualified service personnel.

## Remarks

1. This VCR is also capable of receiving SECAM type broadcasting programmes (SECAM B/G) and recording/playing back its colour television signals.
2. When a cassette which has been recorded on this VCR is played back on a SECAM VCR, the picture may be reproduced in black and white. When it is played back on a PAL VCR without SECAM capability, the picture may not be reproduced in normal colour.
3. When cassettes recorded on a SECAM VCR or SECAM pre-recorded cassettes are played back on this VCR, the picture may be reproduced in black and white.
4. This VCR is not designed for use in France, where a SECAM VCR should be used instead.

Press the VCR-ON/OFF button ❶ to switch the VCR from on to standby mode or vice versa. In the standby mode, the VCR is still connected to the mains.

**SHOWVIEW is a trademark of Gemstar Development Corporation. The SHOWVIEW system is manufactured under licence from Gemstar Development Corporation.**

# Setting the Remote Control to Operate Your TV

Only Panasonic TVs can be operated with the provided remote control.

The settings for operating the TV with the remote control have already been made.  
No additional settings need to be performed.

However, some Panasonic TVs cannot be operated using this remote control.

## TV Operation

The explanations below show you what functions individual buttons have when the VCR/TV switch 30 is set to "TV".

### \*\*1 TV-ON/OFF button

To switch the TV on from standby mode (OFF) or vice versa.

On some TVs it is only possible to switch the TV to standby mode (OFF) with this button, but not on. In this case, try to turn the TV on with one of the following buttons:

**Numeric buttons 2**

**AV button 3**

**Channel button 29**

### \*\*2 Numeric buttons

To select the programme positions (1–99) on the TV.

### \*\*3 AV button

To select the desired AV input on the TV.

### \*\*29 Channel button

To select the desired programme position (TV station) on the TV.

### \*\*37 Teletext buttons

If your TV is equipped for Teletext reception, you can use these buttons to change the teletext information displayed on the screen and select desired information. For details, refer to your TV's operating instructions.

### \*\*38 TV ASPECT button

To switch the screen format between the wide-screen and other formats.

### \*\*39 VOLUME button

To adjust the volume of the TV.

### \*\*40 TV/TEXT button

To switch between normal TV mode and teletext mode.

## The 3 Methods for Switching to the AV Input on Your Panasonic TV

Your Panasonic TV uses one of three different methods for switching between TV reception and the AV input(s). Perform the operations steps listed for the switching methods A, B and C below to determine which one your Panasonic TV uses.

- 
- A
- 1 Set the VCR/TV switch 30 to "TV".
  - 2 Press the AV button 3 to switch to the AV Input. Each press of the AV button 3 switches between "TV reception" and "AV Input(s)".
- 
- B
- 1 Set the VCR/TV switch 30 to "TV".
  - 2 Press the AV button 3. Colour bars for selecting the AV Input appear on the TV screen.
  - 3 Follow the instructions displayed on the TV screen to select the desired AV Input from the displayed colour bars for the AV Input by pressing the corresponding colour button ^ (red) 10, DATE+ (green) 11, ON+ (yellow) 22 or OFF+ (blue) 21 on the remote control.
- 
- C
- 1 Set the VCR/TV switch 30 to "TV".
  - 2 Press the AV 3 button. The last previously selected AV Input indication appears on the TV screen. The indications for selecting another AV Input also appear, but they disappear a few seconds later.
  - 3 Before the indications for selecting another AV Input disappear, press the v button 10, DATE- button 11, ON- button 22 or OFF- button 21 to select the desired AV input. With the following four buttons, you can move and select as follows:  
v 10: Move left  
DATE- 11: Move down  
ON- 22: Move up  
OFF- 21: Move right
-



# Connecting the VCR to a TV

**Method 1.** If you are connecting your VCR to a TV using RF coaxial cable and 21-pin Scart cable, then follow the steps below. (AV Connection)

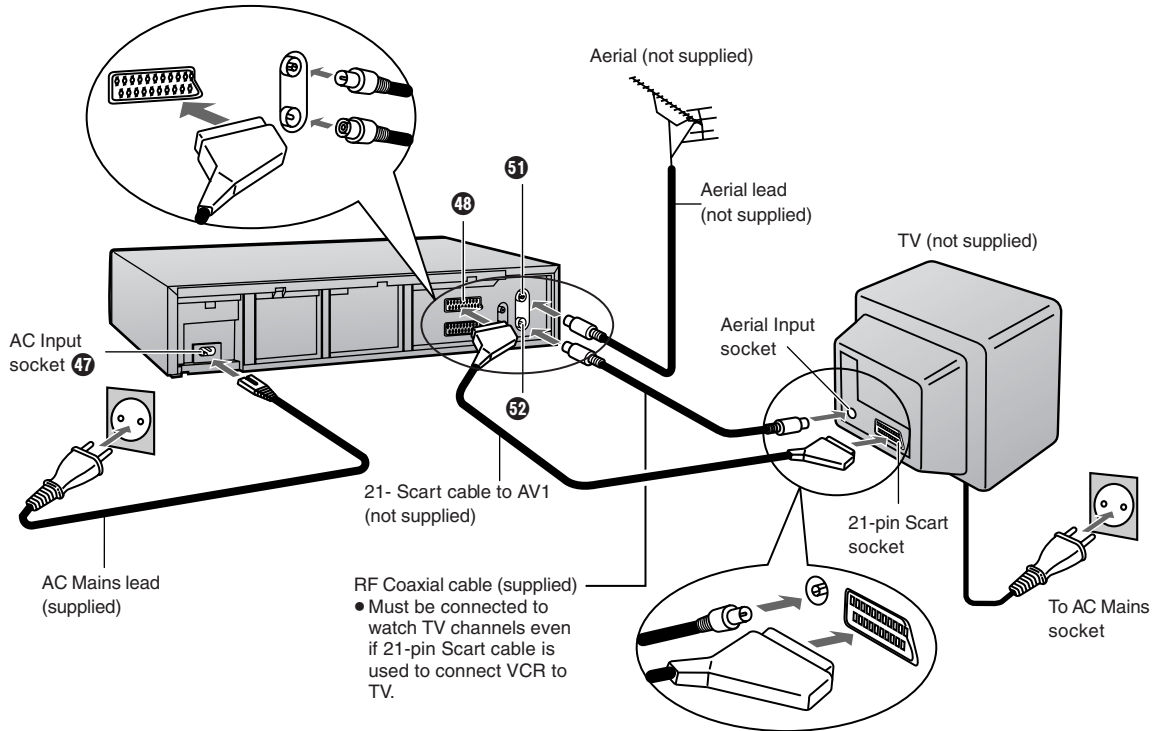

After completing the above connections, proceed to the Auto Setup page (Page 8).

**or Method 2.** If you are connecting your VCR to a TV using only RF coaxial cable, then follow the steps below. (RF Connection)

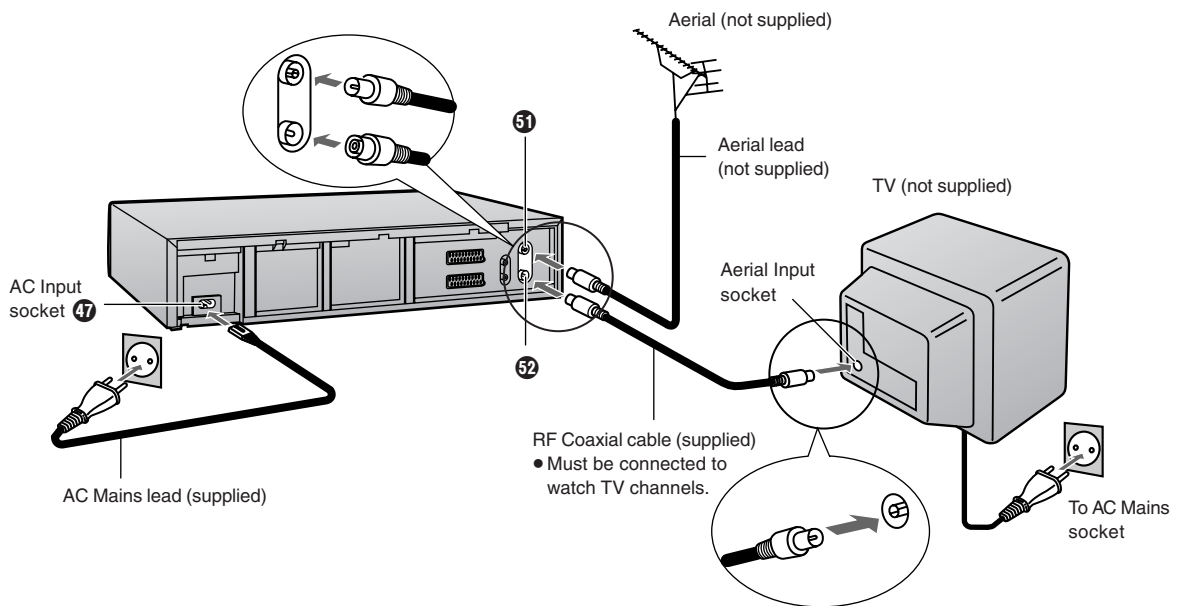

After completing the above connections, proceed to the Auto Setup page (Page 9).

If you are connecting your VCR to a TV using Method 1, follow the operations explained below.

## Auto Setup Function

The Auto Setup function automatically tunes all available TV stations and sets the VCR's clock to the current date and time. If the tuning and time/date settings are not correct, performing timer recordings is not possible.

- 1 Switch the TV on.
- 2 Select the AV input on your TV.
- 3 Set the VCR/TV switch ③① to "VCR".

- 4 Press the VCR-ON/OFF button ① to switch the VCR on. The Country setting menu appears on the TV screen.

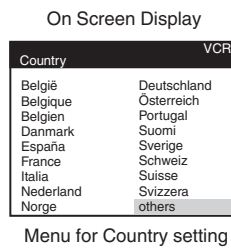

- 5 Press the Cursor buttons (▲▼◀▶) ③② to select the country where you are using the VCR.

- 6 Press the OK button ③④ and the VCR's Auto Setup automatically starts and tunes all available TV stations and also sets the clock. This takes about 5 minutes.

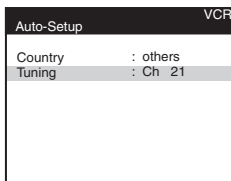

- 7 When the indication shown on the right appears on the VCR display, the Auto Setup is complete.

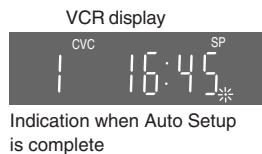

- 8 Press the MENU button ③⑤ for more than 5 seconds so that the RF output channel number appears on the VCR display. The initial setting is channel 36.

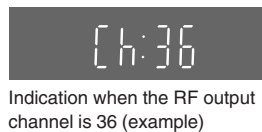

- 9 Press the Numeric button "0" ② so that the displayed RF output channel number changes to "--".

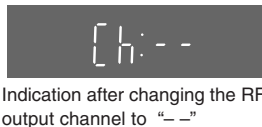

- 10 Press the OK button ③④ to conclude the setting.

- ◆ **To Cancel the Auto Setup Before It Has Finished**  
Press the EXIT button ③③.

### Hint:

- If you select "Schweiz", "Suisse" or "Svizzera" on the Country setting menu, the Functions setting menu appears automatically to let you set the item "Power save" to "ON". In this setting, the VCR's power consumption is minimised when it is off (Standby mode). To turn the VCR on, keep the VCR-ON/OFF button ① pressed on the VCR main unit. It is not possible to turn it on with the remote control.

### When the clock setting menu appears after Auto Setup has finished:

- 1 Press the Cursor buttons (▲▼◀▶) ③② to set the correct time and date.
- 2 Press the OK button ③④ to conclude the setting.

### To Confirm that the TV Stations Have Been Tuned Correctly by the Auto Setup Function

- 1 Press the MENU button ③⑤ to display the OSD Main menu on the TV screen.

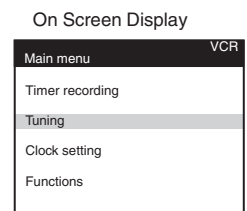

- 2 Press the Cursor buttons (▲▼) ③② to select "Tuning" and press the OK button ③④ then select "Manual".

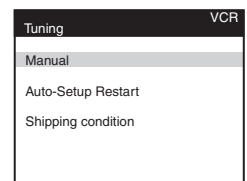

- 3 Press the OK button ③④ to display the list of tuned TV stations and confirm that all available TV stations have been set correctly.

Tuning

Pos	Name	Ch
1	ARD	1
2	ZDF	2
3	N3	19
4	HR3	26
5	BR3	18
6	RB3	3
7	SFB3	36
8	SW3	29

List of tuned TV stations (example)

- 4 Press the EXIT button ③③ to exit the On Screen Display.

### When the station names and/or channel numbers have not been set correctly:

See page 21 for details.



If you are connecting your VCR to a TV using Method 2, follow the operations explained below.

To be able to watch the VCR picture on the TV, RF connection requires the video playback channel to be set on the TV.

- 1 Switch the TV on.
- 2 Select an unoccupied programme position (which is not tuned to a TV station).  
If you are using a Panasonic TV, select programme position "0".
- 3 Set the VCR/TV switch **30** to "VCR".
- 4 Press the VCR-ON/OFF button **1** to switch the VCR on.

- 5 Press the MENU button **35** for more than 5 seconds. The number of the RF output channel appears on the VCR display. The initial setting is channel 36.

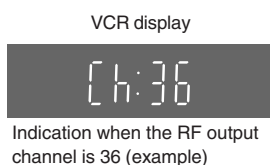

- 6 Tune your TV until the test pattern shown on the right appears on the TV screen. Now, the setting of the RF output channel is complete.

- As the tuning method differs depending on the TV you are using, refer to your TV's operating instructions for details about tuning.

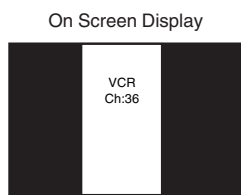

- 7 Press the OK button **34**. The Country setting menu appears on the TV screen.

- 8 Press the Cursor buttons (▲▼◀▶) **32** to select the country where you are using the VCR.

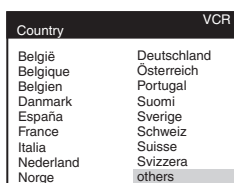

- 9 Press the OK button **34** and the VCR's Auto Setup automatically starts and tunes all available TV stations and also sets the clock. This takes about 5 minutes.

- If you select "Schweiz", "Suisse" or "Svizzera" on the Country setting menu, see page 8.

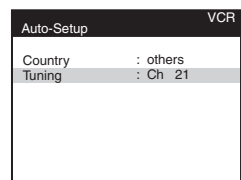

- 10 When the indication shown on the right appears on the VCR display, the Auto Setup is complete.

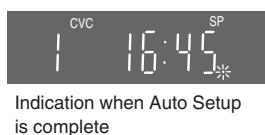

**When the clock setting menu appears after Auto Setup has finished:**

See page 8.

### To Confirm that the TV Stations Have Been Tuned Correctly by the Auto Setup Function

See page 8.

### If the Picture on the TV's Video Playback Channel Is Distorted

If, after setup, you select the video playback channel on the TV and view a TV programme on a programme position selected on the VCR, some interference may occur in certain cases. If this happens, you can minimise the distortion by changing the RF output channel on the VCR to another number. Follow the operations below.

- 1 Set the VCR/TV switch **30** to "VCR".
- 2 Press the MENU button **35** for more than 5 seconds. The number of the RF output channel appears on the VCR display. The initial setting is channel 36.

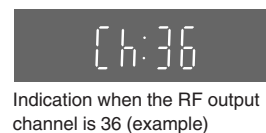

- 3 Press the numeric buttons **2** to change the RF output channel. Enter a channel number which differs by 2 or 3 from the one initially set number. For example, as the original number is 36, enter 39.



- 4 Press the OK button **34** to conclude the setting.

**Note When You Have Changed the RF Output Channel:** After changing the RF output channel to a different number, be sure to retune your TV to the VCR's new RF output channel. (For details about tuning, refer to your TV's operating instructions.)

- 1 Press the MENU button **35** for more than 5 seconds.
- 2 When the test pattern shown on the right appears sharp and clear on the TV screen, the tuning is complete.

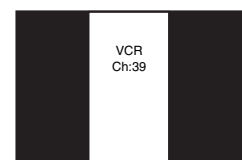

- ◆ **To Cancel the Auto Setup Before It Has Finished** Press the EXIT button **33**.

- 3 Press the EXIT button **33** to exit the On Screen Display.

# Playback

## Preparations

- Confirm that the VCR is on.
- Confirm that the TV is on and the VCR viewing channel is selected.
- Insert a recorded video cassette.

## For Normal Playback:

Press the Play button 24.

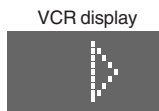

## For Cue Playback:

During playback, tap the Fast Forward button 23.

- To return to normal playback, press the Play button 24.
- If you press and hold down the Fast Forward button 23, cue playback continues for as long as you keep the button pressed.



## For Review Playback:

During playback, tap the Rewind button 3.

- To return to normal playback, press the Play button 24.
- If you press and hold down the Rewind button 3, review playback continues for as long as you keep the button pressed.



## For Still Playback:

During playback, press the Pause/Slow button 7.

- To return to normal playback, press the Play button 24 or the Pause/Slow button 7.



## For Slow Playback:

During playback, keep the Pause/Slow button 7 pressed for 2 seconds or more.

- To return to normal playback, press the Play button 24.



## Fast-forwarding or Rewinding the Tape:

To fast-forward the tape:

Press the Fast Forward button 23 in the stop mode.

To rewind the tape:

Press the Rewind button 3 in the stop mode.

- To stop fast-forwarding or rewinding, press the Stop button 9.
- To briefly view the picture during fast-forwarding or rewinding, press and hold down the corresponding button.

## To Stop Playback

Press the Stop button 9.

## Notes:

- Cue, review or slow playback will be automatically cancelled after 10 minutes, and still playback after 5 minutes.
- During playback function other than normal playback, horizontal noise bars may appear in the picture, the colour of the picture may be unstable, or the picture may be otherwise distorted.  
When you play back a tape recorded in the LP mode, the picture may be in black and white. However, these are not malfunctions.

## To Play Back a Recorded Part Repeatedly

Press the Play button 24 on the remote control for more than 5 seconds.

The "R" indication appears on the On Screen Display.

- If "OSD" is set to "OFF" (See page 26), the "R" indication will not appear in repeat playback mode.

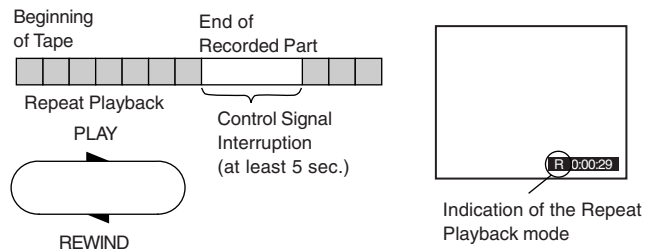

## To Cancel the Repeat Playback Mode:

Press the Stop button 9.

## To rewind the tape a little to view the same scene again (Replay Function)

If you want to view the same scene again, for example because you could not catch clearly what a person said, simply press the REPLAY button 4, to rewind the tape a little from its present position and play it back again.

The direction in which the tape is rewound depends on what playback mode the VCR is in when you press the REPLAY button 4.

- If you press the REPLAY button 4 when the VCR is in the stop, rewind, fast-forward, slow playback, or standby (Off) mode, the Replay function does not work.

## During Normal Playback, Cue Playback and Still Playback:

When you press the REPLAY button 4, the VCR switches over to the review playback mode for a few seconds and then resumes normal playback.

## During Review Playback:

When you press the REPLAY button 4, the VCR briefly switches over to Cue playback and then plays back at normal speed in forward direction from the point where the REPLAY button 4 was pressed.

## To Stop Playback Automatically (Playback Off Timer Function)

If you set the playback duration, the playback will stop automatically.

After the set playback time has elapsed, the VCR automatically stops playback and switches off.

### To Activate the Playback Off Timer Function:

During normal playback, press the Play button **24** on the VCR for more than 2 seconds to put the VCR in the Playback Off Timer mode.

After that, press the Play button **24** on the VCR repeatedly until the desired playback duration is displayed on the VCR display.

- Repeatedly pressing this button changes the indication in the following order:

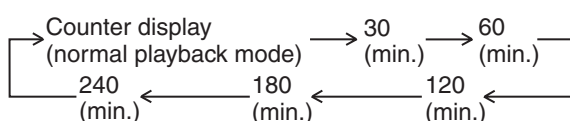

### To Stop Midway:

Press the Stop button **9**.

## To Play Back NTSC Video Cassettes on Your PAL TV (Quasi-NTSC Playback Function) (NV-FJ610 Series only)

This VCR allows playback of tapes recorded in the NTSC system on a normal PAL system TV with the same operations as usual.

On some TVs, however, the playback picture may roll up or down.

- If your TV has a V-HOLD control or equivalent adjustment function, use it to try to stop the picture movement.

## Convenient Automatic Functions

### VCR Auto Power On

When you insert a video cassette, the VCR switches on automatically.

### Auto Playback Start

When you insert a video cassette with a broken erasure prevention tab, playback start automatically without having to press the Play button **24**.

### VCR-off Playback

When the VCR is off, an inserted cassette can be played back by pressing the Play button **24**.

### Auto Rewind

When the tape reaches the end, the VCR automatically rewinds it to the beginning.

- This function does not work during timer recording and OTR.

### Automatic Switching Off and Ejection

When the VCR is switched off, and inserted cassette can be ejected simply by pressing the EJECT button **41**. The VCR will eject the cassette and automatically turn itself off again.

### VCR-off Search

When the VCR is off, the VCR starts intro-jet scan of an inserted cassette by pressing the SEARCH button **23**.

## To Eject the Video Cassette Using the Remote Controller

Keep pressing Stop button **9** for at least 3 seconds.

# Recording

## Preparations

- Confirm that the VCR is on.
- Confirm that the TV is on and the VCR viewing channel is selected.
- Set the VCR/TV switch **30** to "VCR".

## Operations

### 1 Insert a video cassette with an intact erasure prevention tab.

- If it has already been inserted, press the VCR-ON/OFF button **1** to turn the VCR on.

### 2 Select the TV station using the Channel buttons **25**.

- It is also possible to select by pressing the numeric buttons **2**.

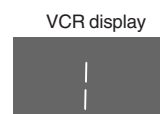

### 3 Press REC (REC/OTR) button **25** (**46**) to start recording.



### 4 Press the Stop button **9** to stop recording.

## To Select the Desired Tape Speed

Press the SP/LP button **20** before recording.

- SP provides standard recording time and optimum picture quality.
- LP provides doubled recording time with slightly reduced picture quality.



## To Pause Recording

Press the Pause/Slow button **7** during recording.

Press again to continue recording.



## To View One TV Programme while Recording Another TV Programme

After pressing the REC button **25** to start recording, select on your TV the programme position of the TV programme that you want to view.

## Notes:

- When playing back an E300 cassette recorded in the LP mode, some picture distortion may occur. However, this is not a malfunction.
- The recording pause mode will be automatically cancelled after 5 minutes and return to the stop mode.

## To Display the Approximate Remaining Tape Time

The remaining tape time can be displayed in the VCR display.

- 1 Press the TAPE button **18** and select the corresponding cassette tape length. See page 26.
- 2 Press the OSD/DISPLAY button **5** repeatedly until the Remaining Tape Time appears on the VCR display.
  - Pressing the OSD/DISPLAY button **5** once makes the On Screen Display appear; after that, pressing it repeatedly changes the indication in the following order:

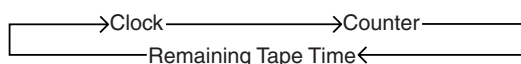

For certain cassettes, the remaining tape time may not be displayed correctly.

## To Prevent Accidental Erasure of Recorded Contents

When you record again onto a previously recorded video cassette, the previous recording is automatically erased and replaced with the new recording. Therefore, to prevent accidental erasure of the recorded contents, break out the erasure prevention tab after recording.

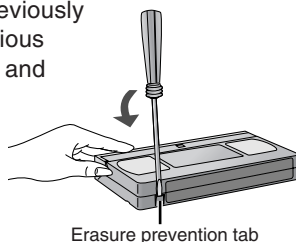

Use a screwdriver or similar tool to break out the tab.

## To Record Again onto the Video Cassette with a Broken Out Erasure Prevention Tab:

If you insert a video cassette with a broken out erasure prevention tab and press the REC button **25**, the "OO" indication flashes on the VCR display to indicate that recording is not possible. In this case, cover the tab hole with two layers of adhesive tape.

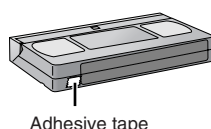

The adhesive tape substitutes for the prevention erasure tab and makes it possible to record again on this cassette.

## To Select the Recording Duration and Perform Timer Recording (OTR Recording)

OTR means One-Touch Recording and is called this way, because you can start recording and select the recording duration by repeatedly pressing a single button. This is very convenient, for example when you want to start recording immediately but need to go out or want to go to bed. After the selected recording duration has elapsed, recording stops and the VCR automatically switches off.

## To Perform an OTR Recording:

- 1 Display the VCR picture on the TV.
- 2 Insert a video cassette with an intact erasure prevention tab.
- 3 Press the Channel buttons **29** to select the programme position on which the TV programme to be recorded will be broadcast.
- 4 Press the REC/OTR button **46** to start recording.
- 5 Press the REC/OTR button **46** repeatedly to select the desired recording duration.
  - Every time you press this button, the recording duration indicated in the VCR display changes in the following order.
  - For example, if you select "30", the VCR records a programme from that moment on for 30 minutes.

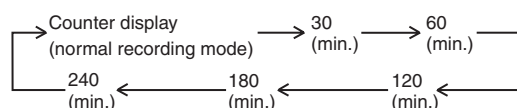

## To Stop the OTR Recording Before the End:

Press the Stop button **9**.

## Linked Timer Recordings with a Digital Receiver

When the AV2 socket of this VCR is connected by a 21-pin cable to a Digital Receiver, it is possible to have timer recordings for a Digital Receiver execute automatically simply by switching the Digital Receiver into timer standby mode and then switching this VCR into timer recording standby mode.

• **Note that linked timer recordings may not work properly with some Digital Receivers.**

- 1 Make sure that "AV2" is set to "TIMER". (See page 27.)
- 2 Insert a video cassette with an intact erasure prevention tab into the VCR.
- 3 Switch the Digital Receiver over to the timer standby mode.
- 4 Press the TIMER REC button **19** to switch the VCR over to the timer recording standby mode.
  - This VCR does not require any further special timer recording operations.
  - The recording will start at the date and time programmed for the Digital Receiver.

## Notes:

- Always connect the Digital Receiver to be used for timer recordings to the AV2 socket of this VCR using a 21-pin cable.
- Linked timer recordings are not counted in the total time of timer recording programmings.
- Make sure that the date and time of the linked timer recording does not conflict with that of a VCR. If programmed recordings do overlap, either linked timer recording or timer recording of VCR have the priority.

# Timer Recording

This function lets you programme the VCR for unattended automatic recording of desired TV programmes when you are not at home or sleeping.

You can programme timer recordings in two different ways:

- By entering the necessary information with the remote control while viewing the On Screen Display (OSD) on the TV screen (explained below) or;
- By entering the ShowView number published alongside the TV programme listings in newspapers and magazines (see page 14).

This VCR lets you programme up to 8 TV programmes (including weekly and daily programmes) for unattended recording up to one month in advance.

## To Programme with the On Screen Display (OSD)

This method offers easy step-by-step programming with the remote control while you view the prompts on the TV screen.

### Preparations

- Confirm that the VCR is on.
- Confirm that the TV is on and the VCR viewing channel is selected.
- Insert a video cassette with an intact erasure prevention tab.
- Set the VCR/TV switch **30** to "VCR".

### Example:

Programming the timer recording of a TV programme broadcast on programme position 2 (ZDF) from 20:00 to 21:30 on 27 October.

Follow the on screen operation guide.

### Operations

- 1 Press the PROG./CHECK button **12** to display the menu for programming timer recordings on the TV screen.**

- Alternatively, you can press the MENU button **35** and then select "Timer recording".

On Screen Display

Timer recording						VCR
Pos	DATE	Start ON	Stop OFF	SP LP	VPS PDC	
ZDF	27/10	20:00	21:30	SP	ON	

- 2 Press the Channel buttons **10** to select the programme position of the desired TV station.**

- As an alternative method, after pressing the Channel button **10**, you can use the Cursor (**▲▼◀▶**) **32**.

- 3 Press the DATE button **11** to set the date on which the TV programme will be broadcast.**

- 4 Press the ON button **22** to set the starting time.**

- When it is kept pressed, the indication changes in 30-minute intervals.

- 5 Press the OFF button **21** to set the ending time.**

- 6 Press the SP/LP button **20** to set the desired tape speed.**

- SP provides standard recording time and optimum picture quality.  
LP provides doubled recording time with slightly reduced picture quality.  
Regarding the "A" indication, refer to page 15.

- 7 Press the Cursor button (**▲▼◀▶**) **32** to set VPS/PDC to ON or OFF (---).**

- See page 15 for VPS/PDC recording.

- 8 Press the TAPE button **18** to select the corresponding cassette tape length.**  
(See page 26.)

- 9 Press the OK button **34** to conclude the settings.**

- To programme additional timer recordings, repeat operation steps 2–9.

Timer recording						VCR
Pos	DATE	Start ON	Stop OFF	SP LP	VPS PDC	
ZDF	27/10	20:00	21:30	SP	ON	

- 10 Press the TIMER REC button **19** to switch the VCR over to the timer recording standby mode.**

- Check that **[ ]** is lit on the VCR display.  
If it is flashing, check the timer recording details again. (See page 15.)

## To Suspend the Timer Recording Standby Mode

When you want to use the VCR for playback, normal recording or some other operation before the programmed timer recording will be performed, you can temporarily suspend the timer recording standby mode by pressing the TIMER REC button **19** so that the "[ ]" indication on the VCR display disappears.

However, after you have finished using the VCR, be sure to reactivate the timer recording standby mode by pressing the TIMER REC button **19** again, otherwise the programmed timer recording will not be performed.

### Note:

- If the VCR is not put in the timer recording standby mode at the latest 10 minutes before the programmed timer recording starting time, the "[ ]" indication flashes on the VCR display. In this case, press the TIMER REC button **19** to put the VCR in the timer recording standby mode.



## To Programme with the ShowView Function

The ShowView numbers assigned to each TV programme and published alongside the TV programme listings in newspapers and magazines make it extremely easy to set the VCR for timer recording.

The duration of a timer recording programmed with ShowView number may be slightly longer than the actual duration of the TV programme.

### Preparations

- Confirm that the VCR is on.
- Confirm that the TV is on and the VCR viewing channel is selected.
- Insert a video cassette with an intact erasure prevention tab.
- Set the VCR/TV switch ⑩ to "VCR".

### Example:

Programming a timer recording of a TV programme with the ShowView number 920126

### Operations

**1** Press the SHOW VIEW button ⑳ to display the menu for entering the ShowView number on the TV.

**2** Press the Numeric buttons ㉑ to enter the ShowView number.

- If you have entered a wrong digit, press the Cursor button (◀) ㉒ and then enter the correct digit.

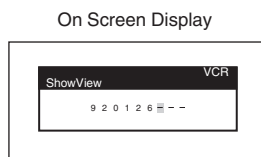

**3** Press the OK button ㉓ to display the programmed content.

**4** Press the SP/LP button ㉔ to set the desired tape speed.

- SP provides standard recording time and optimum picture quality.
- LP provides doubled recording time with slightly reduced picture quality.

Timer recording		VCR				
Pos	DATE	Start ON	Stop OFF	SP LP	VPS PDC	
ZDF	27/10	20:00	21:30	SP	ON	
---	---	---	---	---	---	
---	---	---	---	---	---	

- Regarding the "A" indication, refer to page 15.
- To extend the ending time or to make any corrections, use the Cursor button (▲▼◀▶) ㉒, the Channel buttons ⑩, the DATE button ⑪, the ON button ㉑, the OFF button ㉒, the SP/LP button ㉔.
- See page 15 for VPS/PDC recording.

**5** Press the TAPE button ⑩ to select the corresponding cassette tape length.  
(See page 26.)

**6** Press the OK button ㉓ again to conclude the settings.

- To programme additional timer recordings, repeat operation steps 1–6.

Timer recording		VCR				
Pos	DATE	Start ON	Stop OFF	SP LP	VPS PDC	
ZDF	27/10	20:00	21:30	SP	ON	
---	---	---	---	---	---	
---	---	---	---	---	---	

**7** Press the TIMER REC button ㉕ to switch the VCR over to the timer recording standby mode.

- Check that "☐" is lit on the VCR display.  
If it is flashing, check the timer recording details again.  
(See page 15.)

## If "--" Appears under "Pos/Name" after Entering a ShowView Number

Pos/Name stands for Programme Position/TV Station Name. Normally, the name of the TV station or the number of the programme position is displayed under "Pos/Name".

However, if the TV station information was not automatically set during Auto Setup due to adverse reception conditions, the "--" indication appears instead.

In such a case, follow the operation steps below to correct it.

Press the Channel buttons ⑩ repeatedly to select the programme position on which the TV programme to be recorded will be broadcast.

Timer recording		VCR				
Pos	DATE	Start ON	Stop OFF	SP LP	VPS PDC	
---	---	15:00	17:00	SP	---	
---	---	---	---	---	---	
---	---	---	---	---	---	

"--" indication

After you have entered the information of a TV station, it remains stored in the VCR's memory, and you do not need to enter it again in the future.

## To Suspend the Timer Recording Standby Mode

When you want to use the VCR for playback, normal recording or some other operation before the programmed timer recording will be performed, you can temporarily suspend the timer recording standby mode by pressing the TIMER REC button ㉕ so that the "☐" indication on the VCR display disappears.

However, after you have finished using the VCR, be sure to reactivate the timer recording standby mode by pressing the TIMER REC button ㉕ again, otherwise the programmed timer recording will not be performed.

### Note:

- If the VCR is not put in the timer recording standby mode at the latest 10 minutes before the programmed timer recording starting time, the "☐" indication flashes on the VCR display. In this case, press the TIMER REC button ㉕ to put the VCR in the timer recording standby mode.



# Other Timer Recordings and Convenient Functions

## Setting the Recording Date/Day(s)

Perform this operation in operation step 3 when programming a timer recording with the On Screen Display, or in operation step 4 when programming with the ShowView number. (See pages 13 and 14.)

You can select the recording date (day of the month/day of the week) by pressing the DATE button **1**. If you repeatedly press the + side of the DATE button **1**, the indication changes in the order shown below. If you press the - side of the DATE button **1**, the indication changes in the opposite order.

- Programming a timer recording (setting the date) is possible up to one month ahead of the TV programme's broadcasting date and time. Daily and weekly timer recordings will continue until you cancel them.



## Ensuring that a TV Programme Will Be Recorded until Its End (Auto SP/LP Change Function)

If, at the start of a timer recording, the VCR determines that the remaining tape time is insufficient to record the whole programme, the Auto SP/LP Change function automatically selects LP mode to ensure that the whole programme will be recorded. However, if the remaining tape time is still not sufficient even in the LP mode, the programme cannot be recorded to its end.

- If you programme a daily or weekly timer recording, recording will be performed in the LP mode from the start regardless of the remaining tape time.
- In case of a timer recording programmed with the VPS/PDC function, if the TV programme continues past the programmed ending time, the VCR automatically switches over to the LP mode at that moment. However, in some cases it may not be possible to record the programme until its end.
- Use a video cassette on which a few minutes more than the total length of programmed timer recordings remain, otherwise the programmed timer recordings may be performed in the LP mode.
- Be careful that the broadcast times of the TV programmes set for timer recording do not overlap, otherwise the programmed timer recordings may be performed in the LP mode.
- If the recording speed changes from SP to LP during a timer recording, some brief picture distortion occurs at that point.

Condition for correct operation of the Auto SP/LP Change function:

- The tape length of the inserted cassette must be set correctly. (See page 26.)

### To Activate the Auto SP/LP Change Function:

In operation step 6 when programming a timer recording with the On Screen Display (see page 13), or in operation step 4 when programming with the ShowView number (see page 14), press the SP/LP button **20** to select "A".

- When you press this button repeatedly, the indication changes in the following order:

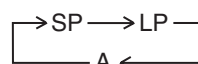

Timer recording						VCR
Pos	Name	DATE	Start ON	Stop OFF	SP LP	VPS PDC
ZDF		27/10	20:00	21:30	A	OFF
---	---	---	---	---	---	---
---	---	---	---	---	---	---
---	---	---	---	---	---	---
---	---	---	---	---	---	---

Indication when "A" is selected

## Setting for Control of the Recording Starting and Ending Time by Special Signal Included in the Broadcasting Signal (VPS/PDC Function)

VPS stands for Video Programme System.

PDC stands for Programme Delivery Control.

If a TV programme, for example a football game runs longer than scheduled, is shortened or starts earlier or later, this function synchronises the recording start and stop with the actual broadcasting start and stop of the TV programme.

Conditions for correct operation of the VPS/PDC function:

- "ON" must be displayed under "VPS/PDC" on the On Screen Display.
- The TV station must broadcast VPS/PDC signals.
- The programme starting time must be set correctly to the starting time listed in the newspaper/magazine.

### To Activate the VPS/PDC Function:

After operation step 6 when programming a timer recording with the On Screen Display (see page 13), or in operation step 4 when programming with the ShowView number (see page 14), press the Cursor buttons (▲▼◀▶) **32** to make the ON indication appear. See page 29 for details.

Timer recording						VCR
Pos	Name	DATE	Start ON	Stop OFF	SP LP	VPS PDC
ZDF		27/10	20:00	21:30	SP	ON
---	---	---	---	---	---	---
---	---	---	---	---	---	---
---	---	---	---	---	---	---
---	---	---	---	---	---	---

## To Check the Contents of Timer Recording Programmings

- Display the VCR picture on the TV.
- Set the VCR/TV switch **30** to "VCR".

- Press the PROG./CHECK button **12** to display the timer recording programmings on the TV screen.
  - When the VCR is in the timer recording standby mode for a VPS/PDC recording, the On Screen Display may be distorted.

- Press the EXIT button **33** to exit the On Screen Display.

Timer recording						VCR
Pos	Name	DATE	Start ON	Stop OFF	SP LP	VPS PDC
ZDF		27/10	20:00	21:30	SP	ON
ARD		30/10	19:00	20:00	LP	ON
N3		Su	21:00	23:30	SP	ON
ZDF		Su-Sa	17:30	18:00	LP	ON
---	---	---	---	---	---	---
---	---	---	---	---	---	---

Timer Recording

## To Change a Timer Recording Programming

It is not possible to change a programming while the timer recording is being performed.

- Display the VCR picture on the TV.
  - Set the VCR/TV switch ⑩ to "VCR".
- 1 Press the PROG./CHECK button ⑫ to display the timer recording programmings on the TV screen.
  - 2 Press the Cursor buttons (▲▼) ⑬ to select the programming that you want to change.
  - 3 Follow the operations below to change the programmed contents.  
To change the broadcasting station:  
Use the Channel buttons ⑩.  
To change the date of the timer recording:  
Use the DATE button ⑪.  
To change the recording starting time:  
Use the ON button ⑲.  
To change the recording ending time:  
Use the OFF button ⑳.  
To change the recording speed:  
Use the SP/LP button ㉑.
- 4 Press the OK button ⑭ to conclude the setting.
  - 5 Press the EXIT button ⑮ to exit the On Screen Display.

Timer recording							VCR
Pos	Name	DATE	Start ON	Stop OFF	SP LP	VPS PDC	
ZDF		27/10	20:00	21:30	SP ON		
ARD		30/10	19:00	20:00	LP ON		
NRG		Su	21:00	23:30	SP ON		
ZDF		Su-Sa	17:30	18:00	LP ON		
----	----	----	----	----	----	----	----

## To Cancel the Programming of a Timer Recording

It is not possible to cancel a programming while the timer recording is being performed.

- Display the VCR picture on the TV.
  - Set the VCR/TV switch ⑩ to "VCR".
- 1 Press the PROG./CHECK button ⑫ to display the timer recording programmings on the TV screen.
  - 2 Press the Cursor buttons (▲▼) ⑬ to select the programming that you want to cancel.
  - 3 Press the CANCEL ⑱ button.
  - 4 Press the EXIT button ⑮ to exit the On Screen Display.

Timer recording							VCR
Pos	Name	DATE	Start ON	Stop OFF	SP LP	VPS PDC	
ZDF		27/10	20:00	21:30	SP ON		
ARD		30/10	19:00	20:00	LP ON		
NRG		Su	21:00	23:30	SP ON		
ZDF		Su-Sa	17:30	18:00	LP ON		
----	----	----	----	----	----	----	----

Timer recording							VCR
Pos	Name	DATE	Start ON	Stop OFF	SP LP	VPS PDC	
ZDF		27/10	20:00	21:30	SP ON		
ARD		30/10	19:00	20:00	LP ON		
NRG		Su	21:00	23:30	SP ON		
ZDF		Su-Sa	17:30	18:00	LP ON		
----	----	----	----	----	----	----	----

### Notes for Cancelling the Programming of a Timer Recording

- In some cases, for example as listed below, the programming of a timer recording remains stored in the memory until 4 a.m. the next day. However, this is not a malfunction.
- When a timer recording was not performed up to the TV programme's ending time because the remaining tape time was not sufficient.
  - When you have stopped the timer recording while it was being performed.

## To Check the Total Timer Recording Programming Time

The total time indication for timer recording programming lets you check how many programmes can be recorded by comparing with the remaining tape time in the VCR display.

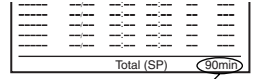

Indication for a total timer recording programming time of 90 minutes

- The total time is calculated in the SP mode.
- The total time cannot be calculated when setting Daily/Weekly timer recording.

## To select a Timer-Recorded Programme from the List and Quickly Locate Its Beginning for Automatic Playback (Programme List Search)

This VCR can display a list of the timer-recorded programmes on the inserted video cassette on the TV screen. You can then select the desired programme, and the VCR will quickly locate its beginning and start playback.

Conditions for correct operation of the Programme List Search function:

- The video cassette must not have been ejected after the timer recordings were performed.
- The tape length of the inserted cassette must be set correctly.
- The VCR must not be in the timer recording standby mode.
- A programme of at least 15 minutes must be recorded on the tape.
- If a timer recording was performed onto a recorded video cassette, the previous recording must have been completely erased by the new recording.

### Preparation

- Display the VCR picture on the TV.

Programme List				VCR
Pos	Name	Date	Start	
2	ZDF	27/10	17:46	
3	ARD	28/10	15:00	

### Operations

- 1 Press the SEARCH button ㉔ to display the Programme List menu.
- 2 Press the Cursor buttons (▲▼) ⑬ to select the programme that you want to locate and play back.
- 3 Press the SEARCH button ㉔ to start the search for the beginning of the selected programme.
  - After the desired recorded programme has been found, playback starts automatically.
  - If, after playback has started, you want to search for the beginning of the same or another programme, press the SEARCH button ㉔. Playback stops, and the Programme List menu appears. Repeat the above operations steps 2-3.

### To Cancel the Programme List Search:

Press the EXIT ⑮ button.

### Hints:

- When you press the SEARCH button ㉔ in the operation step 1, the last timer-recorded programme is selected (highlighted).
- If you take out the cassette or insert another cassette after a timer recording has finished, pressing the SEARCH button ㉔ activates the Intro-Jet Scan instead of the Programme List Search. (Refer to page 17.)
- If you programme linked timer recordings, Programme List Search function does not work.

# Search Functions

## To Quickly Find the Beginning of a Desired Programme (VISS=VHS Index Search System)

This VCR automatically records special index signals on the tape every time a recording is started. The Index search function makes use of these index signals to let you find the beginning of a desired programme quickly and easily.

Index signals are automatically recorded in the following cases:

- When you start a recording by pressing the REC button 25, or REC/OTR button 46.
- When a timer recording starts.
- When you press the REC button 25 on the remote control during recording.

Conditions for correct operation of the Index search function:

- The VCR must be in the stop mode or in the playback mode.
- Each programme recorded on the tape must be at least 5 minutes long.

### Preparations

- Display the VCR picture on the TV.
- Insert a recorded video cassette.

### Operation

- 1 Press the INDEX button 26 (that corresponds to the direction from the current tape position in which the desired programme is located on the tape) to start the index search. For example, if you want to search for the 2nd recorded programme in forward direction, press the INDEX ►► button 26 twice.
  - The VCR fast-forwards or rewinds the tape and searches for the specified index signal (the beginning of the desired recorded programme). When it has been found, playback starts automatically.



### To Cancel the Index Search or to Stop Playback:

Press the Stop button 9.

### Hints:

- Searching in either direction is possible up to the 20th index signal.
- If you press either of the INDEX buttons 26 too many times, simply press the other INDEX button 26 (indicating the opposite direction) to correct it. In this way, you can reduce the displayed figure down to 1.
- The figure on the VCR display decreases by 1 every time an index signal is located.

## To Search for a Desired Programme While Checking the Recorded Contents on a Cassette (Intro-Jet Scan)

This VCR automatically records special index signals on the tape every time a recording starts. The Intro-Jet Scan function makes use of these index signals to play back the beginning of each programme recorded on the cassette one after another at high speed. This lets you quickly and easily check the contents of a cassette and find a desired programme.

Index signals are automatically recorded in the following cases:

- When you start a recording by pressing the REC button 25, or REC/OTR button 46.
- When a timer recording starts.
- When you press the REC button 25 on the remote control during recording.

Conditions for correct operation of the Intro-Jet Scan function:

- The cassette must have been ejected after the timer recordings were performed.
- VCR must be switched on, be in the playback mode or be in the standby mode.
- Each programme recorded on the tape must be at least 15 minutes long.

### Preparations

- Display the VCR picture on the TV.
- Insert a recorded video cassette.

### Operations

- 1 Press the SEARCH button 28 to start the Intro-Jet Scan.
  - After rewinding the tape to the beginning, the VCR plays it back at high speed for approximately 10 seconds. It then fast-forwards the tape to the next tape position marked by an index signal (beginning of a programme), and every time an index signal is found, the VCR switches over to high-speed playback (Cue) for about 10 seconds.

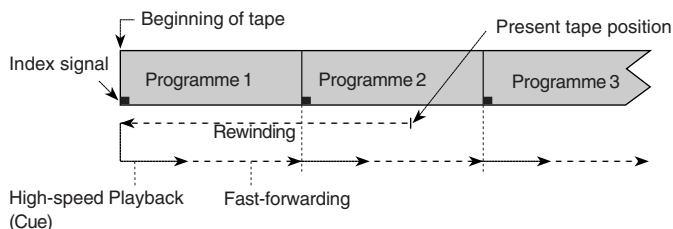

- 2 When you have found the programme that you want to view, press the Play button 24 to start normal playback.

### To Cancel the Intro-Jet Scan or to Stop Playback:

Press the Stop button 9.

### Note:

- If you press the SEARCH button 28 after a timer recording has finished, but before ejecting that cassette, the Programme List Search (for details, see page 16) will be activated instead of the Intro-Jet Scan.

# Editing

## Assemble Editing

The assemble editing function makes it easy to record the picture and sound of virtually any number of scenes or programmes in succession.

Assemble editing from an external source, for example from a movie camera, can be performed in the same way.

Recording unit (this VCR)

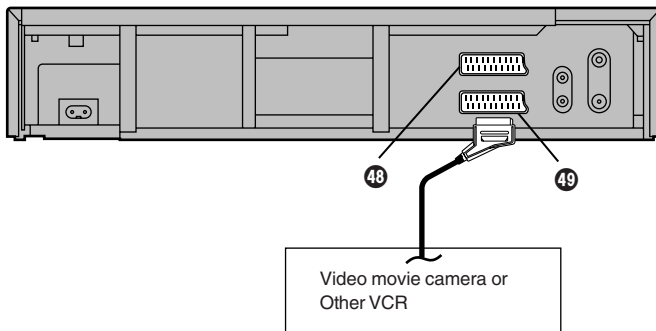

### Preparations

- Connect a video movie camera or a VCR to this VCR with a 21-pin Scart cable, as shown in the illustration.
- Display the VCR picture on the TV.
- Insert the cassette on which the assemble editing is to be performed, and make sure that its erasure prevention tab is not broken out.
- Set the VCR/TV switch ⑩ to "VCR".
- Press the INPUT SELECT button ③ to select the AV Input (external input) "A1" or "A2" according to the socket(s) on the VCR to which the source unit has been connected.

A1: When connected to the AV1 21-pin Scart socket 48

A2: When connected to the AV2 21-pin Scart socket 49

- Make sure that "AV2" is set to "EXT".

(See page 27.)

### Operations

- 1 Press the Play button 24 to start playback.
- 2 At the point where you want to join a new scene, press the Pause/Slow button 7 to put it in the still playback mode.
- 3 Press the REC button 25 to put it in the recording pause mode.
- 4 Start playback on the source unit and search for the point from which you want to record (copy) onto this VCR.

- 5 When that point is reached, press the Pause/Slow button 7 again to start recording the new picture and sound from the playback unit.
- 6 To record (copy) additional scenes, press the Pause/Slow button 7 to put this VCR in the recording pause mode and then perform above steps 4 and 5 again.
- 7 At the point where you want to stop recording, press the Stop button 9 to finish recording.

### Hint:

- The new sound is recorded on both the Hi-Fi audio tracks and the normal audio track. The sound recorded on the normal audio track is always in mono.

### Note:

- If you leave the VCR in the recording pause mode for more than 5 minutes in step 3 or 6, the VCR automatically switches over to the stop mode to protect the video heads.

# Connecting the VCR to a Decoder/ Connecting the VCR to a Stereo Amplifier

To connect this VCR to a decoder or a stereo amplifier, make the connections shown in the illustration below. For the connection to the TV, see page 7.

For details about the connection, also read the operating instructions of the decoder or stereo amplifier.

Be sure to keep the VCR, TV and decoder or stereo amplifier switched off until you have finished all connections. For your safety, do not connect or handle the equipment with wet hands.

## To Connect the VCR to a Decoder

Decoder here refers to the device used to decode scrambled broadcasts (Pay TV).

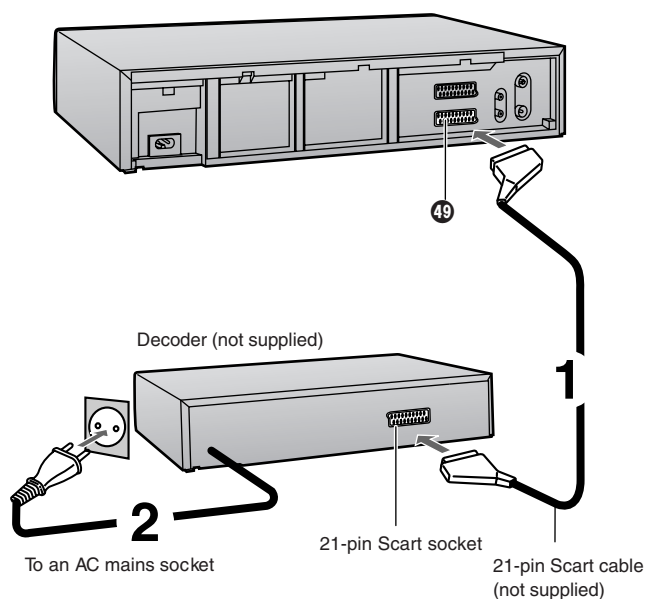

- 1 Connect a 21-pin Scart cable (not supplied) to the AV2 21-pin Scart socket 49 on the VCR and to the 21-pin Scart socket on the decoder.
- 2 Connect the decoder's mains lead to an AC mains socket.
- 3 Set "AV2" to "DECODER". For details, see page 27.

### AV Link Function

If the VCR is connected to the TV via a 21-pin Scart cable, you can use AV LINK button 17 to switch the TV from normal TV reception over to the video playback channel (AV input) (and vice versa). In the VCR mode (when the VCR indication in the VCR display is lit), the TV is switched to the video playback channel (AV input). In the TV mode (when the VCR indication is not lit), the TV is switched to TV reception.

	VCR	TV
<b>VCR Mode</b>	VCR indication is lit.	AV Input is selected.
<b>TV Mode</b>	VCR indication is not lit.	TV reception is selected.

- When you press the MENU button 45 to display the menu on the TV screen, the TV is also automatically switched to the VCR mode, however, the VCR indication does not appear in this case.

- When you start playback on the VCR, the TV is automatically switched to the VCR mode. However, during playback, it is not possible to switch the TV back to the TV mode.
- If a Pay TV station has been selected on the VCR when you switch to the TV mode, the picture on the TV is scrambled when you select a Pay TV station on the TV. In this case, either switch to the VCR mode or select the AV input on the TV.

### Hint:

"RGB" means separate Red/Green/Blue colour signals. If you connect a TV equipped with RGB input capability to the AV1 socket 48 on this VCR, and a decoder equipped with RGB output capability to the AV2 socket 49, the TV can receive RGB signal input from the decoder via the VCR.

## To Connect the VCR to a Stereo Amplifier

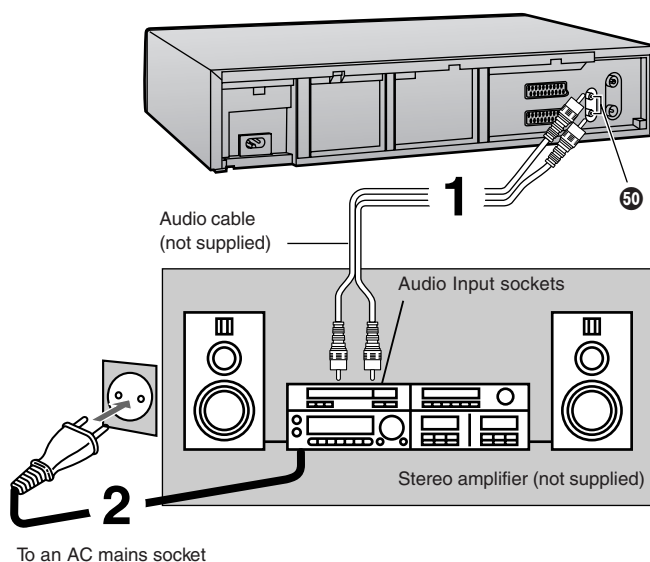

- 1 Connect an Audio cable (not supplied) to the Audio Output sockets 50 on the VCR and to Audio Input sockets on the stereo amplifier.
- 2 Connect the stereo amplifier's mains lead to an AC mains socket.



# Connecting the VCR to a Satellite Receiver or Digital Receiver

Satellite receiver here includes a digital receiver.

The connection method differs depending on the type of your satellite receiver.

For details about the connection, also read the satellite receiver's operating instructions.

## If the Satellite Receiver is Equipped with a 21-pin Scart Socket

If your satellite receiver is equipped with a 21-pin Scart socket, use a 21-pin Scart cable to connect the VCR.

For the connection to the TV, refer to page 7.

Be sure to keep the VCR, TV and satellite receiver switched off until you have finished all connections. For your safety, do not connect or handle the equipment with wet hands.

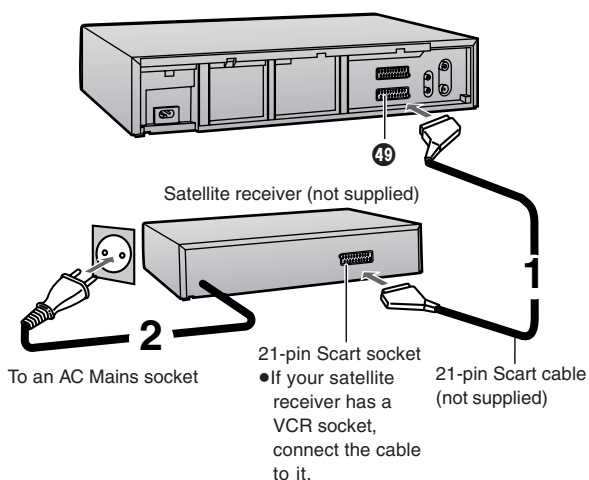

- 1 Connect a 21-pin Scart cable (not supplied) to the AV2 21-pin Scart socket 49 on the VCR and to the 21-pin Scart socket on the satellite receiver.
- 2 Connect the satellite receiver's mains lead to an AC mains socket.
- 3 Set "AV2" to "EXT" or "TIMER". For details, see page 27.

## If the Satellite Receiver Is Not Equipped with a 21-Pin Scart Socket

In case your satellite receiver is not equipped with a 21-pin Scart socket, use the RF coaxial cable to connect it to the VCR.

For the connection to the TV, refer to page 7.

Be sure to keep the VCR, TV and satellite receiver switched off until you have finished all connections. For your safety, do not connect or handle the equipment with wet hands.

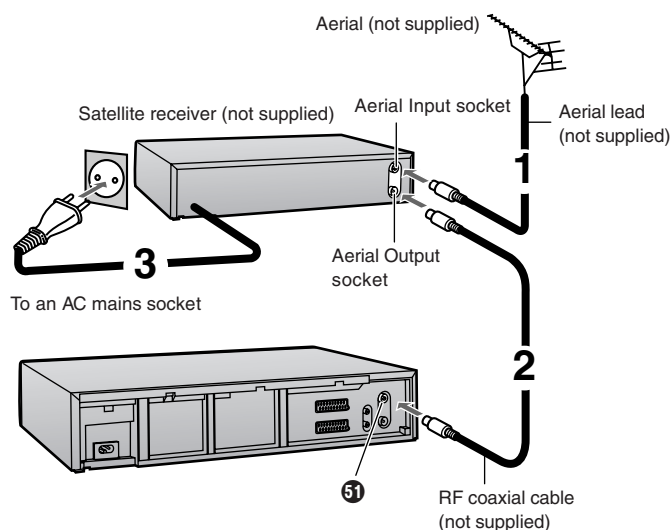

- 1 Connect the aerial lead to the Aerial Input socket on the satellite receiver.
- 2 Connect the RF coaxial cable to the Aerial Output socket on the satellite receiver and to the Aerial Input socket 51 on the VCR.
- 3 Connect the satellite receiver's mains lead to an AC mains socket.

### Hint:

- The RF output channel of the satellite receiver should be adjusted away from channel 36, which is used by the VCR, e.g. re-adjust to channel 33.



# Tuning and Assigning the TV Stations Available in Your Area to the Programme Positions (Manual Tuning)

This VCR has 99 programme positions that can be preset to receive TV stations.

Usually, if you switch the VCR on for the first time after making the necessary connections, the VCR will start the Auto Setup function automatically so that all available TV stations in the area can be received.

However, if Auto Setup is not successful due to extraordinary transmission circumstances, or if you want to change the name of a TV station or change a TV station from its regular programme position to one of your preference, you can set it up manually. This is called Manual Tuning.

## Preparation

- Set the VCR/TV switch **30** to "VCR".

## To Change the Order in Which the TV Stations Are Assigned to the Programme Positions

- 1 Press the MENU button **35** to display the Main menu on the TV screen.
- 2 Press the Cursor buttons (**▲▼**) **32** to select "Tuning" then press the OK button **34**.
- 3 Press the Cursor buttons (**▲▼**) **32** to select "Manual" then press the OK button **34** to display the list of tuned TV stations.
- 4 Press the Cursor buttons (**▲▼**) **32** to select the TV station that you want to assign to a different programme position.
- 5 Press the OK button **34** to display the Manual Tuning menu.
- 6 Press the Cursor buttons (**▲▼◀▶**) **32** to select the entry field for "Pos".
- 7 Press the Numeric buttons **2** to enter the number of the desired programme position.
- 8 Press the OK button **34** to conclude the setting.
- 9 Press the EXIT button **33** to exit the On Screen Display.

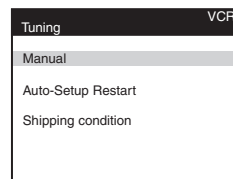
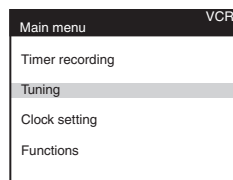

Pos	Name	Ch
1	ARD	1
2	ZDF	2
3	N3	19
4	HR3	26
5	BR3	18
6	RB3	3
7	SFB3	36
8	SW3	29

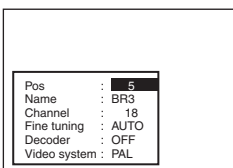

## To Enter or Change the Name of a TV Station

- 1 Press the MENU button **35** to display the Main menu on the TV screen.
- 2 Press the Cursor buttons (**▲▼**) **32** to select "Tuning" then press the OK button **34**.
- 3 Press the Cursor buttons (**▲▼**) **32** to select "Manual" then press the OK button **34** to display the list of tuned TV stations.
- 4 Press the Cursor buttons (**▲▼◀▶**) **32** to select a programme position whose TV station name is indicated as \*□□□□.
- 5 Press the OK button **34** to display the Manual Tuning menu.
- 6 Press the Cursor buttons (**▲▼◀▶**) **32** to select the entry field for "Name".
- 7 Use the Cursor buttons (**▲▼◀▶**) **32** and OK button **34** to enter the station name.
  - If the station name needs a blank space, select the blank between "Z" and "\*".
- 8 Press the EXIT button **33** to exit the On Screen Display.

Pos	Name	Ch
1	ARD	1
2	ZDF	2
3	N3	19
4	HR3	26
5	BR3	18
6	RB3	3
7	*:*07	39

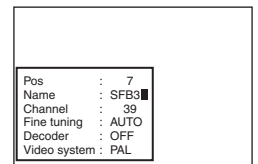

## Hint:

- If you want to abort the entering or changing of the TV station name in step 7 above, press the EXIT button **33**. However, as the characters that you have entered are stored as the station name, be sure to enter the correct name.

## To Enter Newly Available TV Stations

- 1 Press the MENU button **35** to display the Main menu on the TV screen.
- 2 Press the Cursor buttons (**▲▼**) **32** to select "Tuning" then press the OK button **34**.
- 3 Press the Cursor buttons (**▲▼**) **32** to select "Manual" then press the OK button **34** to display the list of tuned TV stations.
- 4 Press the Cursor buttons (**▲▼◀▶**) **32** to select an unused programme position.
- 5 Press the OK button **34** to display the Manual Tuning menu.
  - Wait a few moments until the desired TV station has been tuned.
- 7 Press the OK button **34** to conclude the setting.
- 8 Press the EXIT button **33** to exit the On Screen Display.

Pos	Name	Ch
1	ARD	1
2	ZDF	2
3	N3	19
4	HR3	26
5	BR3	18
6	RB3	3
7	**07	39
8	----	----

Pos	: 8
Name	: ***08
Channel	: 2
Fine tuning	: AUTO
Decoder	: OFF
Video system	: PAL

## To Obtain the Best Tuning Condition

- 1 Press the MENU button **35** to display the Main menu on the TV screen.
- 2 Press the Cursor buttons (**▲▼**) **32** to select "Tuning" then press the OK button **34**.
- 3 Press the Cursor buttons (**▲▼**) **32** to select "Manual" then press the OK button **34** to display the list of tuned TV stations.
- 4 Press the Cursor buttons (**▲▼◀▶**) **32** to select the TV station for which you want to obtain the best tuning condition.
- 5 Press the OK button **34** to display the Manual Tuning menu.
- 6 Press the Cursor buttons (**▲▼◀▶**) **32** to select the entry field for "Fine tuning".
  - If you do not want to change the tuning condition, press the Cursor button (**▶**) **32** to return to the original condition (AUTO).
- 7 Press the Cursor buttons (**▲▼**) **32** to obtain the best tuning condition.
- 8 Press the OK button **34** to conclude the setting.
- 9 Press the EXIT button **33** to exit the On Screen Display.

Pos	: 5
Name	: BR3
Channel	: 18
Fine tuning	: MAN
Decoder	: OFF
Video system	: PAL

## To Change the Channel Number of an Already Tuned TV Station:

You can change it in the same way as explained above. However, in step 4 select the programme position of the TV station that you want to change to another channel number, and after pressing the OK button **34** in step 5, use the Cursor buttons (**▲▼◀▶**) **32** to select the entry field for "Channel".

## List of TV Reception Channels

Channel Indication	TV Channel	
	Germany/Italy	Other Countries
2-12	*E2-E12	E2-E12
13-20	A-H (Only Italy)	—
21-69	21-69	21-69
74-78	S01-S05	S1-S5
80-82	S1-S3	M1-M3
83-89	S4-S10	M4-M10
90-99	S11-S20	U1-U10
121-141 Hyperband	**S21-S41	S21-S41

\* In Italy: H1...(11), H2...(12)

\*\* Only for 8 MHz channel raster

## To Preset Pay TV Stations

- 1 Press the MENU button **35** to display the Main menu on the TV screen.
- 2 Press the Cursor buttons (**▲▼**) **32** to select "Tuning" then press the OK button **34**.
- 3 Press the Cursor buttons (**▲▼**) **32** to select "Manual" then press the OK button **34** to display the list of tuned TV stations.
- 4 Press the Cursor buttons (**▲▼◀▶**) **32** to select the pay TV station.
- 5 Press the OK button **34** to display the Manual Tuning menu.
- 6 Press the Cursor buttons (**▲▼◀▶**) **32** to select the entry field for "Decoder".
  - Press the Cursor buttons (**▲▼**) **32** to select "ON".
- 7 Press the Cursor buttons (**▲▼**) **32** to select "ON".
  - ON: To preset pay TV stations.
  - OFF: To preset normal TV stations.
- 8 Press the OK button **34** to conclude the setting.
- 9 Press the EXIT button **33** to exit the On Screen Display.

Pos	: 5
Name	: BR3
Channel	: 18
Fine tuning	: AUTO
Decoder	: ON
Video system	: PAL

## To Change the Type of Video System (Colour TV system)

- 1 Press the MENU button **35** to display the Main menu on the TV screen.
- 2 Press the Cursor buttons (**▲▼**) **32** to select "Tuning" then press the OK button **34**.
- 3 Press the Cursor buttons (**▲▼**) **32** to select "Manual" then press the OK button **34** to display the list of tuned TV stations.
- 4 Press the Cursor buttons (**▲▼◀▶**) **32** to select the TV station for which you want to change the type of video system.
- 5 Press the OK button **34** to display the Manual Tuning menu.
- 6 Press the Cursor buttons (**▲▼◀▶**) **32** to select the entry field for "Video system".
- 7 Press the Cursor buttons (**▲▼**) **32** to change the type of video system "PAL" or "MESECAM".  
 PAL: For receiving PAL signals.  
 MESECAM: For receiving SECAM signals.
- 8 Press the OK button **34** to conclude the setting.
- 9 Press the EXIT button **33** to exit the On Screen Display.

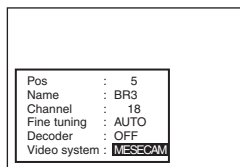

## To Select the Type of Sound to Be Recorded (NV-FJ610EC/ECM/ECY Series, FJ606EC/ECM Series, FJ604ECM Series)

- 1 Press the MENU button **35** to display the Main menu on the TV screen.
- 2 Press the Cursor buttons (**▲▼**) **32** to select "Tuning" then press the OK button **34**.
- 3 Press the Cursor buttons (**▲▼**) **32** to select "Manual" then press the OK button **34** to display the list of tuned TV stations.
- 4 Press the Cursor buttons (**▲▼◀▶**) **32** to select the desired TV station.
- 5 Press the OK button **34** to display the Manual Tuning menu.
- 6 Press the Cursor buttons (**▲▼◀▶**) **32** to select the entry field for "Mono".
- 7 Press the Cursor buttons (**▲▼**) **32** to select "OFF".
  - Select "ON" if you want to record the normal (mono) sound on the Hi-Fi audio tracks during a stereo, bilingual or NICAM broadcast, or if the stereo sound is distorted due to inferior reception conditions.
- 8 Press the OK button **34** to conclude the setting.
- 9 Press the EXIT button **33** to exit the On Screen Display.

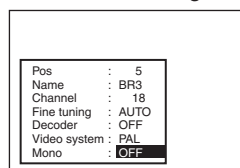

## To Facilitate the Following Operations with the Instruction Indications on the On Screen Display

- To delete a programme position
- To insert a blank programme position
- To move a TV station to another programme position

Use the coloured instruction indications displayed below the list of tuned TV stations and the corresponding coloured buttons.

- 1 Press the MENU button **35** to display the Main menu on the TV screen.
- 2 Press the Cursor buttons (**▲▼**) **32** to select "Tuning" then press the OK button **34**.
- 3 Press the Cursor buttons (**▲▼**) **32** to select "Manual" then press the OK button **34** to display the list of tuned TV stations.
- 4 Press the Cursor buttons (**▲▼◀▶**) **32** to select the desired TV station.
- 5 Follow the operations below.  
 To delete a programme position (Delete):  
 Press the Channel button (**^**, red) **10**.  
 To insert a blank programme position (Add):  
 Press the DATE button (**+**, green) **11**.  
 To move a TV station to another programme position (Move):  
 Press the ON button (**+**, yellow) **22**, and then use the Cursor buttons (**▲▼**) **32** to select the new programme position to which you want to assign the TV station.
- 6 Press the OK button **34** to conclude the setting.
- 7 Press the EXIT button **33** to exit the On Screen Display.

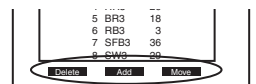

Indications for Delete, Add and Move

### Hint:

- If you have performed Manual Tuning to enter TV stations, the "—" indication may appear under "Pos/Name" on the On Screen Display when programming a ShowView timer recording.

# Restarting the Auto Setup/ Resetting the VCR to the Shipping Condition

---

Performing Auto Setup automatically tunes all TV stations available in your area for the VCR.

Restarting this function is convenient when you move to another area and may need to set up the VCR again.

## To Restart the Auto Setup

To perform the Auto Setup again, follow the operation steps below.

- 1 Press the MENU button **35** to display the Main menu on the TV screen.

- 2 Press the Cursor buttons (**▲▼**) **32** to select "Tuning" then press the OK button **34**.

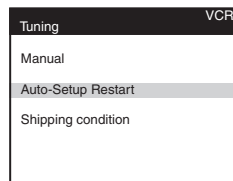

- 3 Press the Cursor buttons (**▲▼**) **32** to select "Auto-Setup Restart" then press the OK button **34** to prepare for Auto Setup start.

- 4 Press the OK button **34** again to actually start the Auto Setup.

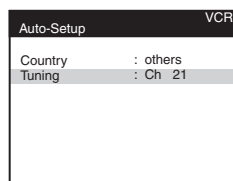

## To Return the VCR to the Shipping Condition

If you want to reset the VCR to the factory preset condition, follow the operation steps below.

- 1 Press the MENU button **35** to display the Main menu on the TV screen.

- 2 Press the Cursor buttons (**▲▼**) **32** to select "Tuning" then press the OK button **34**.

- 3 Press the Cursor buttons (**▲▼**) **32** to select "Shipping condition" then press the OK button **34** to prepare for resetting the VCR to the shipping condition.

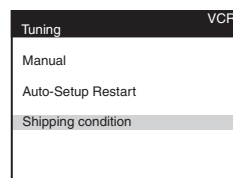

- 4 Press the OK button **34** to actually change the settings back to the shipping condition.
  - To re-tune the VCR, disconnect and reconnect the AC Mains Cable.

# Setting the VCR's Clock

Usually, the VCR's Auto Setup function automatically adjusts the clock to the correct time.

Under some reception conditions, however, the VCR cannot set the clock automatically.

In this case, follow the operation steps below to manually set the clock.

## To Manually Adjust the Clock

1 Press the MENU button **35** to display the Main menu on the TV screen.

2 Press the Cursor buttons (**▲▼**) **32** to select "Clock setting" then press the OK button **34**.

- The Clock setting menu appears on the TV.

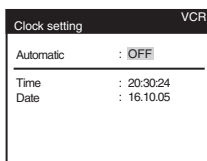

3 Confirm that "Automatic" is set to "OFF", and then press the OK button **34**.

4 Use the Cursor buttons (**▲▼◀▶**) **32** to set the date and time.

- Instead of the Cursor buttons (**▲▼◀▶**) **32**, you can also use the numeric buttons **2** to set the date and time.

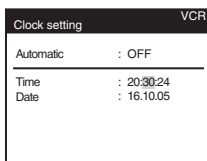

5 Press the OK button **34** to conclude the setting.

6 Press the EXIT button **33** to exit the On Screen Display.

## To Activate the Automatic Time Correction Function

If a TV station transmits a signal for time setting, performing the operation steps below activates the Automatic time correction function and the time is corrected automatically.

1 Press the MENU button **35** to display the Main menu on the TV screen.

2 Press the Cursor buttons (**▲▼**) **32** to select "Clock setting" then press the OK button **34**.

- The Clock setting menu appears on the TV.

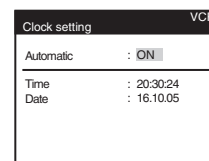

3 Use the Cursor buttons (**▲▼**) **32** to set "Automatic" to "ON".

4 Press the OK button **34** to conclude the setting.

- Under adverse reception conditions, etc., the Automatic time correction function may not work. In this case, the indication for "Automatic" is automatically reset to "OFF". If the reception conditions improve later on, it may be possible to activate this function.

5 Press the EXIT button **33** to exit the On Screen Display.

### Hints:

- If "Automatic" is set to "ON" when you open the Clock screen, do not set it to "OFF", otherwise, the automatic time correcting function is deactivated.
- The built-in clock employs the 24-hour system.
- In case of a power failure, an automatic back-up system automatically maintains the operation of the clock for at least 60 minutes.
- When "Automatic" on the Clock setting menu is set to "ON", the automatic time correction function checks and if necessary adjusts the time several times every day. The automatic time correction function only works when the VCR is switched off; it does not work in the timer recording standby mode.
- If "Automatic" is set to "OFF" and "Power save" to "ON" (see page 27), the time may not be maintained correctly. In this case, manually adjust the clock.
- If "Automatic" is set to "ON" and "Power save" to "ON", the Automatic time correction function does not work while the VCR is turned off. However, as soon as it is turned on, the Automatic time correction function is activated and the clock is set correctly.

# Other Convenient Functions (Various Settings)

## For Automatic Display on the TV Screen of the TV Station Information, etc.

- 1 Press the MENU button **35** to display the Main menu on the TV screen.
- 2 Press the Cursor buttons (**▲▼**) **32** to select "Functions" then press the OK button **34**.
- 3 Press the Cursor buttons (**▲▼◀▶**) **32** to select "OSD" and the entry field for "OSD" in this order.
- 4 Press the Cursor buttons (**▲▼**) **32** to select "ON".
  - The TV station information, type of sound system of the programme being watched and the sound playback mode are displayed on the TV screen.
- 5 Press the OK button **34** to conclude the setting.
- 6 Press the EXIT button **33** to exit the On Screen Display.

### Indications that Can Be Displayed on the TV Screen with This Function:

At a press of the OSD/DISPLAY button **5**, the following indications appear on the TV screen.

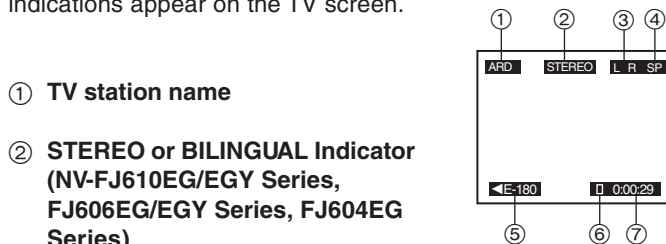

- ① **TV station name**
- ② **STEREO or BILINGUAL Indicator (NV-FJ610EG/EGY Series, FJ606EG/EGY Series, FJ604EG Series)**  
When receiving a TV programme, the type of sound system in which it is broadcast is automatically indicated.
- STEREO, M1 and M2 Indicator (NV-FJ610EC/ECM/ECY Series, FJ606EC/ECM Series, FJ604ECM Series)**  
When receiving a TV programme with the Stereo, Bilingual or NICAM sound system, the type of sound system in which it is broadcast is automatically indicated.  
STEREO: When receiving a Stereo/NICAM stereo broadcast.  
M1/M2: When receiving a Bilingual/NICAM dual-sound broadcast.  
M1: When receiving a NICAM monaural broadcast.

- ③ **Sound mode during playback (L/R)**  
At each press of the AUDIO button **15**, the selected playback sound is indicated with L (Left) and R (Right).  
Stereo playback:  
The L and R indications are displayed.  
Left audio channel playback:  
The L indication alone is displayed.  
Right audio channel playback:  
The R indication alone is displayed.  
Playback of normal audio track:  
Neither L nor R indication is displayed.

- ④ **Tape speed indicator**

- ⑤ **Tape length indicator**  
At each press of the TAPE button **10**, the selected tape length is indicated.  
◀E-180: For E30, -60, -90, -120 and -180 tapes  
E-195: For E195 tape  
E-240: For E240 tape  
E-260 ▶: For E260 and -300 tapes  
• Even if you have selected the correct tape length, the remaining tape time may not be indicated correctly with certain kinds of cassettes.

- ⑥ **Tape running display**

Stop	□
Rewind	◀◀
Fast Forward	▶▶
Playback	▷
Recording	●
Repeat Playback	R

- ⑦ **Present time/Tape counter/Remaining tape time/Index Search/One-Touch Recording (OTR) /Playback Off Timer Function**

Present time	17:24:31
Tape counter	-2:35.47
Remaining tape time	REMAIN 2:34
Index Search	▶▶ 02
One-Touch Recording (OTR)	OTR 60
Playback Off Timer Function	30

### Notes:

- If "OSD" is set to "OFF", none of the above indications appear.
- None of the above indications appear during special playback.
- During playback and when the AV input for the external source is selected, indications ① and ② do not appear.
- Some of the above indications do not appear when using NTSC tapes.



## For Reduced the VCR's Power Consumption When the VCR Is Switched Off

1 Press the MENU button **35** to display the Main menu on the TV screen.

2 Press the Cursor buttons (**▲▼**) **32** to select "Functions" then press the OK button **34**.

Functions		VCR
OSD	: ON	
Power save	: OFF	
VCR display	: DIMMED	
AV2	: DECODER	
TV system	: PAL	
Language	: English	
Country	: others	

3 Press the Cursor buttons (**▲▼◀▶**) **32** to select "Power save" and the entry field for "Power save" in this order.

4 Press the Cursor buttons (**▲▼**) **32** to select "ON" or "OFF".

**ON:** In this setting, the power consumption is greatly minimised when the VCR is turned off (Standby mode). In this case, the following happens:

- The item "VCR display" is automatically set to "OFF".
- To turn the VCR on, keep the VCR-ON/OFF button **1** pressed on the VCR main unit. It is not possible to turn it on with the remote control.
- The Power save function works only when the VCR is turned off (Standby mode). It does not operate in the timer recording standby mode. After all programmed timer recordings have been made, and after all programmed data have been erased, the VCR switches over to the Power save mode.
- When the VCR is off, Pay TV programmes cannot be watched on the TV because the signal from the connected decoder is not looped through. To watch them, turn on the VCR.

**OFF:** In this setting, the power consumption is not reduced when the VCR is turned off (Standby mode).

5 Press the OK button **34** to conclude the setting.

6 Press the EXIT button **33** to exit the On Screen Display.

## For Automatic Change of the Brightness of the VCR Display When the VCR Is Switched Off

1 Press the MENU button **35** to display the Main menu on the TV screen.

2 Press the Cursor buttons (**▲▼**) **32** to select "Functions" then press the OK button **34**.

Functions		VCR
OSD	: ON	
Power save	: OFF	
VCR display	: DIMMED	
AV2	: DECODER	
TV system	: PAL	
Language	: English	
Country	: others	

3 Press the Cursor buttons (**▲▼◀▶**) **32** to select "VCR display" and the entry field for "VCR display" in this order.

4 Press the Cursor buttons (**▲▼**) **32** to select the desired condition.

- When the VCR is switched off, the brightness of the VCR display is as follows:  
**ON:** Indications are brightly lit.  
**OFF:** Indications are not lit.  
**DIMMED:** Indications are dimly lit.

5 Press the OK button **34** to conclude the setting.

6 Press the EXIT button **33** to exit the On Screen Display.

## To Set the Type of External Source Equipment that Is Connected to the AV2 21-pin Scart Socket

1 Press the MENU button **35** to display the Main menu on the TV screen.

2 Press the Cursor buttons (**▲▼**) **32** to select "Functions" then press the OK button **34**.

Functions		VCR
OSD	: ON	
Power save	: OFF	
VCR display	: DIMMED	
AV2	: DECODER	
TV system	: PAL	
Language	: English	
Country	: others	

3 Press the Cursor buttons (**▲▼◀▶**) **32** to select "AV2" and "DECODER", "TIMER" or "EXT" in this order.

4 Press the Cursor buttons (**▲▼**) **32** to select the type of external source equipment which is connected to the VCR's AV2 21-pin socket.

- Set the external source equipment as follows:  
**DECODER:** When a decoder is connected.  
**TIMER:** When a digital receiver is connected.
  - When this is set, it is possible to have timer recordings for a Digital Receiver execute automatically simply by switching the Digital Receiver into timer standby mode and then switching this VCR into timer recording standby mode. (See page 12.)
- EXT:** When another VCR or a satellite receiver is connected.

5 Press the OK button **34** to conclude the setting.

6 Press the EXIT button **33** to exit the On Screen Display.

## To Set the Colour TV System Used During Playback or Recording from an External Source

- 1 Press the MENU button **35** to display the Main menu on the TV screen.
- 2 Press the Cursor buttons (**▲▼**) **32** to select “Functions” then press the OK button **34**.
- 3 Press the Cursor buttons (**▲▼◀▶**) **32** to select “TV system” and “PAL/MESECAM” in this order.
- 4 Press the Cursor buttons (**▲▼**) **32** to select the type of colour TV system (PAL or MESECAM) to be used during playback or during recording from an external source.
- 5 Press the OK button **34** to conclude the setting.
- 6 Press the EXIT button **33** to exit the On Screen Display.

Functions	VCR
OSD	: ON
Power save	: OFF
VCR display	: DIMMED
AV2	: DECODER
TV system	: PAL
Language	: English
Country	: others

## Language Setting

- 1 Press the MENU button **35** to display the Main menu on the TV screen.
- 2 Press the Cursor buttons (**▲▼**) **32** to select “Functions” then press the OK button **34**.
- 3 Press the Cursor buttons (**▲▼◀▶**) **32** to select “Language” and the entry field for “Language” in this order.
- 4 Press the Cursor buttons (**▲▼**) **32** to select the desired language. Pressing the Cursor button (**▼**) **32** repeatedly changes the indication in the following order:
- 5 Press the OK button **34** to conclude the setting.
- 6 Press the EXIT button **33** to exit the On Screen Display.

Functions	VCR
OSD	: ON
Power save	: OFF
VCR display	: DIMMED
AV2	: DECODER
TV system	: PAL
Language	: English
Country	: others

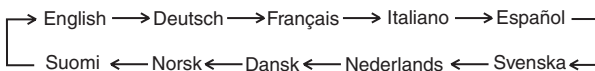

## Country Setting

- 1 Press the MENU button **35** to display the Main menu on the TV screen.
- 2 Press the Cursor buttons (**▲▼**) **32** to select “Functions” then press the OK button **34**.
- 3 Press the Cursor buttons (**▲▼◀▶**) **32** to select “Country” and the entry field for “Country” in this order.
- 4 Press the Cursor buttons (**▲▼**) **32** to select the desired country. Pressing the Cursor button (**▼**) **32** repeatedly changes the indication in the following order:
- 5 Press the OK button **34** to conclude the setting.
- 6 Press the EXIT button **33** to exit the On Screen Display.

Functions	VCR
OSD	: ON
Power save	: OFF
VCR display	: DIMMED
AV2	: DECODER
TV system	: PAL
Language	: English
Country	: others

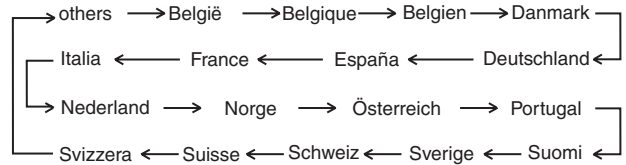

# Glossary

## VPS (Video Programme System)/ PDC (Programme Delivery Control)

The Video Programme System (VPS) or the Programme Delivery Control (PDC) is a very convenient system which assures that the TV programmes you have programmed for timer recording will be recorded exactly from beginning to end, even if the actual broadcasting time differs from the scheduled time due to delayed start or extension of the programme duration. Also, if a programme is interrupted and, for example, some special news is inserted, the recording will also be interrupted automatically and resumed when the programme continues.

Depending on the signals sent from the TV stations, the VPS/PDC system may not operate properly even when "VPS/PDC" has been set to "ON".

Please check with the broadcasters in your area for details.

- In the case of VPS/PDC recording, use the correct time (VPS/PDC time) for recording the TV programmes. Set "VPS/PDC" to "OFF" when the recording time is not the correct time (VPS/PDC time). VPS/PDC recording is not performed when the time (VPS/PDC time) is incorrect, even if only by one minute. To find out the correct time (VPS/PDC time), consult Teletext, a newspaper or magazine, or other source.
- If the actual broadcasting times of timer recordings overlap (regardless of whether they are VPS/PDC controlled), the recording that starts first always has priority, and the recording of the later beginning programme will start only after the first timer recording has finished.
- When the VPS/PDC signal drops out because the broadcast signal is weak, or when a TV station does not transmit a regular VPS/PDC signal, the timer recording will be performed in the normal mode (without VPS/PDC) even if it was programmed for VPS/PDC. In this case, even if the timer recording is performed, whatever has been programmed will not be cancelled at that particular time but at 4 a.m. on the following day.
- The start times of scheduled programmes listed in the newspaper or magazine may be changed at a later date. Set "VPS/PDC" to "OFF" when programming a programme whose start time has been subsequently changed. Particular care must be taken in this respect with ShowView programming since "VPS/PDC" is automatically set to "ON" in some countries.
- If a programme listed in a newspaper or magazine has two ShowView numbers, use the ShowView number for VPS/PDC if you wish to proceed with VPS/PDC recording using ShowView programming.
- The default settings for "VPS/PDC" differ depending on the country concerned. Refer to the table on the right.

Programming method Selected Country	ShowView programming	Changes in ShowView programming start time	Non-ShowView programming
France, Belgium, Netherlands, Sweden, Denmark, Finland, Norway	ON	OFF	OFF
Germany, Switzerland, Austria, Other Countries	ON	ON	ON
Italy, Spain, Portugal	OFF	OFF	OFF

- If the broadcasting station is not transmitting VPS/PDC signals, "---" appears in the menu for timer programming under "VPS/PDC".

## NICAM Broadcasting System (NV-FJ610EC/ECM/ECY Series, FJ606EC/ ECM Series, FJ604ECM Series)

NV-FJ610EC/ECM/ECY Series, FJ606EC/ECM Series, FJ604ECM Series feature the NICAM digital sound system, a 2-channel sound broadcast system that provides either 2 high-quality stereo sound tracks or 2 independent mono sound tracks, M1 and M2.

NICAM programmes are always accompanied by standard (mono) sound broadcasts, and during playback, you can select the desired sound with the AUDIO button **15**.

- The NICAM stereo sound can only be recorded on the Hi-Fi audio tracks.
- If, for some reason, you want to record a stereo, bilingual or NICAM TV programme intentionally in mono on the Hi-Fi audio tracks, set "Mono" to "ON" for the programme position on which the desired programme is broadcast, as described on page 23.

### Important Note on the NICAM System

When NV-FJ610EC/ECM/ECY Series, FJ606EC/ECM Series, FJ604ECM Series are switched on, the tuner automatically switches to a NICAM broadcast if NICAM is being transmitted. During test transmissions, it is possible that the sound received does not correspond to the picture being viewed. In order to receive synchronised sound and picture, select monaural sound with the AUDIO button **15** or setting "Mono" to "ON". This applies only until NICAM transmissions are fully operational.

Even if the sound track is in mono, the STEREO indication will appear.

---

## Crystal View Control (CVC)

The crystal view control function ensures that you always obtain the optimum picture quality so that you get the best picture automatically.

While the VCR is turned on, the CVC indication **44** is always displayed to show that the Crystal View Control is activated.

## 21-pin Scart Socket

The 21-pin Scart socket transmits both input and output signals for picture and sound. TVs equipped with the same type of socket can be connected here.

This type of socket is also called Peritel, Euro Connector and Euro AV.

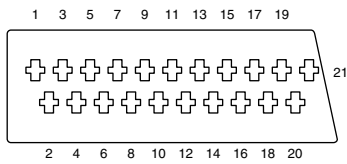

1 Audio output CH2 (R)	12 No connection
2 Audio input CH2 (R)	13 Red ground
3 Audio output CH1 (L)	14 Blanking ground
4 Audio ground	15 Red
5 Blue ground	16 Blanking
6 Audio input CH1 (L)	17 Video output ground
7 Blue	18 Video input ground
8 Switching voltage	19 Video output
9 Green ground	20 Video input
10 Control signal	21 Ground
11 Green	

The Red, Green and Blue (RGB) video signals are looped through only from an external source unit, for example from a connected a pay-TV decoder, i.e. they are not from tape playback.

# Before Requesting Service

Before requesting service, please check the following points.

## ◆ On Screen Display Messages

The error messages are given in brackets [ ].

[Please insert video tape!]

- ☞ You pressed the REC button 25 (REC/OTR button 46), the Play button 24, the Fast Forward button 23, the Rewind button 6 or the SEARCH button 26 when no cassette was inserted in the VCR.  
Insert a video cassette.

[Please use tape with unbroken recording tab!]

- ☞ You pressed the REC button 25 (REC/OTR button 46) when a cassette with a broken out erasure prevention tab was inserted in the VCR.  
Insert a video cassette with an intact erasure prevention tab on which recording is possible.

[This action is not possible before time and date are set]

- ☞ You pressed the SHOW VIEW button 27 or the PROG./CHECK button 12, even though the time and date have not yet been set on the VCR.  
Set the time and date.

[No timer programmes to be done!]

- ☞ You pressed the TIMER REC button 19 even though no timer recording has been programmed.  
Programme a timer recording before pressing the TIMER REC button 19.

[Please put VCR into stop mode first]

- ☞ You attempted to change the contents of the timer programming while a timer recording was being performed.  
Put the VCR into the stop mode first.

Other messages may also appear.  
Follow the instructions given on the TV screen.

## ◆ The VCR Does Not Work Correctly

The symptom descriptions are given between quotation marks “ ”.

“The VCR display is not illuminated.”

- ☞ The AC mains lead is disconnected.  
Connect the AC mains lead securely.
- ☞ VCR display setting is “OFF”. Set “VCR display” to “ON” or “DIMMED”. (See page 27.)
- ☞ Power save setting is “ON”. Set “Power save” to “OFF”. (See page 27.)

“The VCR display is illuminated, but the VCR cannot be operated.”

- ☞ The VCR is in the timer recording standby mode.  
Press the TIMER REC button 19 to cancel the standby mode.
- ☞ Safety devices are operating.  
Disconnect the AC mains lead and wait approximately 1 minute before reconnecting.  
Then check if the VCR can be operated.

“The VCR picture does not appear on the TV screen.”

- ☞ The RF output channel is set to [--].  
Change the RF output channel to a channel other than [--]. (See page 9.)

“Auto clock setting does not work correctly.”

- ☞ Teletext information is not available or cannot be read.  
Set the clock manually.

## ◆ Playback Does Not Work Properly

The symptom descriptions are given between quotation marks “ ”.

“The playback picture is distorted or in black and white. Or, horizontal noise bars appear in the picture or horizontal lines move up and down.”

- ☞ The tracking adjustment is not correct.  
Adjust the tracking. (See page 32.)
- ☞ The TV's video playback channel has not been tuned correctly.  
Re-tune the video playback channel.
- ☞ The video heads are clogged or worn.  
Consult your dealer for advice.
- ☞ The playback picture is distorted when using an E300 type video cassette that was recorded in the LP mode.  
We recommend that you use video cassettes other than type E300.

## ◆ Recording Is Not Possible or Does Not Work Properly

The symptom descriptions are given between quotation marks “ ”.

“When recording is attempted, the  indication flashes.”

- ☞ A video cassette with a broken out erasure prevention tab is used.  
Use a cassette with an intact tab, or if you want to erase the previously recorded contents on the cassette, cover the tab hole with two layers of adhesive tape.

“The playback picture of a recorded programme is distorted or no picture can be seen.”

- ☞ The aerial or aerial lead connection is defective.  
Check the connections. If the picture displayed on the TV is also distorted, there is something wrong with the installation of the aerial.
- ☞ No programme was recorded because the VCR is not tuned correctly.  
Tune it correctly.
- ☞ No programme was recorded because the AV input (A1 or A2) was selected on the VCR.  
Select the programme position of the desired TV programme.

“Timer recording does not work correctly.”

- ☞ Time and date are not set or they are set incorrectly.  
Set the time and date correctly.
- ☞ The starting time or ending time of the timer recording were not programmed correctly.  
Set the starting time or ending time correctly.
- ☞ The VCR was not put in the timer recording standby mode.  
After programming a timer recording, press the **TIMER REC** button  to put the VCR in the timer recording standby mode.

“Recording from an external source connected to the VCR's AV input cannot be made.”

- ☞ The correct AV input (A1 or A2) is not selected.  
Select the correct AV input (A1 or A2).
- ☞ The connections from the external source are not made correctly. Correct them. (See page 18.)

## ◆ The Remote Control Does Not Work Correctly

The symptom descriptions are given between quotation marks “ ”.

“The remote control does not work correctly.”

- ☞ The remote control signal cannot reach the VCR.  
Aim the remote control at the VCR and make sure that the infrared beam's path is not obstructed.
- ☞ The distance to the VCR is too long.  
Use the remote control within 7 metres from the VCR. If you are using it within this range but the remote control still cannot operate the VCR, replace the batteries.
- ☞ The batteries are exhausted.  
Replace with new batteries.
- ☞ The batteries have been inserted with reversed polarities ( $\oplus/\ominus$ ).  
Insert the batteries correctly. (See page 4.)
- ☞ Power save setting is “ON”. Set “Power save” to “OFF”.  
(See page 27.)

## Adjusting the Playback Picture

Under normal conditions, the VCR automatically adjusts the playback picture for optimum quality. However, in some cases it may be necessary to adjust it manually.

### If the Picture Contains Noise Bars and It Is Not Clear to See (Tracking adjustment):

If noise bars appear during normal playback, slow playback or still playback, follow the operations below.

During normal or slow playback, press the Channel button   $\nabla$  (–) or  $\blacktriangle$  (+) until the bars noise disappear.

- If the noise bars appear during still playback, switch the VCR over to the slow playback mode and then adjust the tracking as explained above.



Playback picture containing noise bars

### To Return to Auto Tracking:

Press the Channel buttons   $\nabla$  (–) and  $\blacktriangle$  (+) simultaneously.

### If the Still Picture Scrolls Up or Down (V-Lock Adjustment):

If the still picture scrolls up or down, perform the following operation.

During still playback, keep the Channel button   $\nabla$  (–) or  $\blacktriangle$  (+) pressed until the picture stops scrolling.

### Precautions:

- With certain TV models and tapes, it may not be possible to adjust the tracking.
- If you play back a cassette that was recorded on another VCR, the picture quality may be inferior and it may be necessary to adjust the tracking. Also, on some TVs, the picture may scroll up and down in the special playback functions.  
However, these are not malfunctions.



# Cautions

---

Be sure to read the cautions carefully before you operate this VCR.

---

## Avoid sudden changes in temperature

If the VCR is moved suddenly from a cold to a warm place, condensation may form on the tape surface and inside the VCR. If this happens, leave the VCR at room temperature for at least 1 hour before operating it.

---

## Avoid humidity and dust

Do not use the VCR in very humid or dusty places. This may cause damage to its internal parts.

---

## Do not cover the ventilation holes

The ventilation holes prevent excessive heat build-up inside the VCR during extended periods of use. Do not block these holes; especially avoid covering them with soft materials such as paper or cloth.

---

## Keep the VCR away from high temperatures

Keep the VCR away from extreme heat such as direct sunlight, heating radiators, or closed automobiles.

---

## Avoid magnets or magnetized objects

Never bring a magnet or magnetized object close to the VCR because this could adversely affect the performance of the VCR. When using the VCR together with other equipment, keep as much distance as possible between them to prevent them from adversely affecting each other's performance.

---

## No fingers or other objects inside

Touching internal parts of the VCR is dangerous, and may seriously damage it. Do not attempt to disassemble the VCR. There are no user serviceable parts inside.

---

## Keep water away

Keep the VCR away from flower vases, tubs, sinks, etc. **Caution:** If water or some other liquid is spilled into the VCR, serious damage could occur. If you spill any liquid into the VCR, consult qualified service personnel.

---

## Lightning

To avoid damage by lightning, disconnect the aerial plug from the VCR during lightning storms.

---

## Cleaning the VCR

Wipe the VCR with a clean, dry cloth. Never use any cleaning fluid or other chemicals. Also do not use compressed air to remove dust.

---

## Stacking

Install the VCR in a horizontal position and do not place anything heavy on it.

---

## Video head clogging

The video heads record the picture signals on the tape during recording and read picture signals from the tape during playback. They are, therefore, of critical importance for the picture quality. If the VCR is used for a very long time, these heads may become dirty and clogged with dust and fine particles from the tape coating. In such a case, the signals can no longer be recorded correctly, and the playback picture will be distorted accordingly. This is the case, for example, if during the playback of a tape, which you know to have excellent recording quality, the picture and sound quality are inferior. When such a symptom occurs, have the recorder checked by qualified service personnel.

**Head cleaning by a service center is not covered by warranty.**

---

## Condensation may form in the following cases:

- If the VCR is in a room that was very cold before the heater has just been turned on.
- If the VCR is in a room with steam or high humidity.
- If the VCR is brought from cold surroundings into a well-heated room.
- The VCR is suddenly brought from cool surroundings, such as an air-conditioned room or car, to a place which is hot and humid.

### Note:

In any of the above-mentioned conditions, do not operate the VCR for at least 1 hour.

This VCR is not equipped with a dew sensor.

# Specifications

NV-FJ610 Series  
NV-FJ606 Series  
NV-FJ604 Series

<b>Power Source:</b>	220–240 V AC 50/60 Hz
<b>Power Consumption:</b>	21 W
<b>Power Consumption When in Standby Mode:</b>	Approx. 3 W (When <b>Power save</b> function is activated)

<b>Video Recording System:</b>	2 rotary heads, helical scanning system
<b>Video Heads:</b>	4 heads
<b>Audio Heads:</b>	2 heads (Hi-Fi)
<b>Tape Speed:</b>	SP; 23.39 mm/s LP; 11.7 mm/s
<b>Tape Format:</b>	VHS tape
<b>Record/Playback Time:</b>	SP; 240 min with NV-E240 LP; 480 min with NV-E240
<b>FF/REW Time:</b>	approx. 60 s with NV-E180

## VIDEO

<b>Television System:</b>	CCIR; 625 lines, 50 fields, PAL colour signal
<b>Modulation System:</b>	Luminance; FM azimuth recording Colour signal; converted subcarrier phase shift recording
<b>Input Level:</b>	AV1/AV2; 1.0 Vp-p, 75 ohm, terminated
<b>Output Level:</b>	AV1/AV2; 1.0 Vp-p, 75 ohm, terminated RF Modulated; UHF channel (21–69), 75 ohm

## AUDIO

<b>Input Level:</b>	AV1/AV2; –6 dBV, more than 10 kohm
<b>Output Level:</b>	AV1/AV2; –6 dBV, less than 1 kohm AUDIO OUT (PHONO); –6 dBV, less than 1 kohm
<b>Audio Track:</b>	1 track (Normal-mono only), 2 channels (Hi-Fi sound-stereo)

<b>Video Horizontal Resolution:</b>	Colour; more than 240 lines (SP)
<b>Signal-to-Noise Ratio:</b>	Video; more than 43 dB (SP)
<b>Dynamic Range:</b>	Audio; more than 90 dB (Hi-Fi audio track)
<b>Audio Frequency Response:</b>	20 Hz–20 kHz/Hi-Fi
<b>Wow and Flutter:</b>	0.005% Wrms/Hi-Fi
<b>Operating Temperature:</b>	5°C–40°C
<b>Operating Humidity:</b>	35%–80%
<b>Weight:</b>	3.9 kg
<b>Dimensions:</b>	430 (W)×87 (H)×303 (D) mm
<b>Standard Accessories:</b>	1 pc. RF Coaxial cable 1 pc. Remote Control (EUR571739) 2 pcs. R6 size batteries 1 pc. AC mains lead

Weight and dimensions shown are approximate.  
Specifications are subject to change without notice.