



User Manual



NVR-0204/0208/0216

4-CH/8-CH/16-CH Network Video Recorder

Ver. 1.1

Table of Contents

Copyrights, Trademarks & GPL	3
System Requirements	4
Product Description	5
Hardware Illustration	6
I/O Ports and RS-485	7
LEDs Definition	8
Install Hard Disk	9
Connect to the NVR	12
1. Live View	16
1.1 Retrieve camera's video stream	18
1.2 Retrieve camera's status	18
1.3 Perform Sequence Viewing	19
1.4 PTZ Control	20
1.5 Perform PTZ Preset Viewing	21
1.6 Live Video Control Buttons	23
1.7 Change Web UI Display Language	26
2. Playback	27
2.1 Methods to Search Playback Videos	28
2.2 Export Playback Videos to AVI Files	34
3. System Setup	36
3.1 System Configurations	36
3.1.1 Network Settings	36
3.1.2 Time and Date	38
3.1.3 User Account	39
3.1.4 Group Privilege	40
3.1.5 Disk Setup	42
3.2 Channel Configurations	43
3.2.1 Add a Camera	43
3.2.2 OSD Settings	46
3.2.3 PTZ Preset Settings	47
3.2.4 PTZ Preset Sequence	48
3.2.5 E-Map Monitor	49
3.3 Event Configurations	51
3.3.1 General Settings	51
3.3.2 I/O Settings	52
3.3.3 Event Servers	54
3.3.4 Event Triggers	58
3.4 Recording Configurations	60
3.4.1 General Settings	60
3.4.2 Schedule Recording	62
3.5 System Options	64
3.5.1 Device Information	64
3.5.2 Logs and Reports	65
3.5.3 Maintenance	65
Reboot the NVR	66
Reset the NVR to Factory Default	67
Hardware reset procedure	67
3.5.4 DO Status	68
3.5.5 Disk Status	68
3.5.6 UPS Configuration	69
3.6 NVR Recording time for reference	70

Copyrights , Trademarks & GPL

Copyright

© 2009 Digital Data Communications GmbH.

Trademarks

LevelOne NVR-0204/0208/0216 Network Video Recorder (NVR) is a registered trademark of Digital Data Communications GmbH.

Microsoft and Windows are registered trademarks of Microsoft Corporation.

All other trademarks mentioned in this document are trademarks of their respective owners.

Disclaimer

This document is intended for general information purposes only, and due care has been taken in its preparation.

Any risk arising from the use of this information rests with the recipient, and nothing herein should be construed as constituting any kind of warranty.

Digital Data Communications GmbH reserves the right to make adjustments without prior notification.

All names of people and organizations used in these documents examples are fictitious. Any resemblance to any actual organization or person, living or dead, is purely coincidental and unintended.

General Public License

This product incorporates open source code into the software and therefore falls under the guidelines governed by the General Public License (GPL) agreement.

Adhering to the GPL requirements, the open source code and open source license for the source code are available for free download at <http://global.level1.com>.

If you would like a copy of the GPL or other open source code in this software on a physical CD medium, LevelOne (Digital Data Communications) offers to mail this CD to you upon request, for a price of US\$9.99 plus the cost of shipping.

System Requirements

The following are minimum system requirements for the system to operate LevelOne Network Video Recorder (NVR):

Operating System

Microsoft® Windows® 2000 Professional, Windows® XP Professional (32 bit) or Windows® Server 2003 (32 bit)

Browser

Microsoft Internet Explorer 6 or above

CPU

Minimum Intel® Pentium® 4 2.4 GHz or higher (Dual Core is recommended)

RAM

Minimum 1 GB of RAM, 2GB or above is recommended

Network

Minimum 10/100 Ethernet (Gigabit Ethernet is recommended)

Graphics Adapter

AGP or PCI-Express, minimum 1024x768, 16 bit colors.

(We highly recommend to work above the 1024 x 768 resolution to get the full experience of the software)

- . *Make sure your display DPI setting is set to default at 96DPI*
- . *To set DPI value, right-click on desktop, choose "Settings" tab >> "Advanced" >> "General"*

Contents inside the Installation CD

- . Adobe Acrobat Reader
- . LevelOne Device Search Utility
- . LevelOne NVR Management Software
- . User's Manual
- . Quick installation Guide

Default Settings

IP Address	DHCP address
Username	root
Password	root

LevelOne NVR Series

Network Video Recorder

Product Description



The LevelOne Network Video Recorder is designed for use within a surveillance system, and performs recordings and playbacks pictures from network cameras in the system. It is a recording device using a hard disk drive to record camera pictures instead of using video tapes so that pictures recorded by repeated overwriting will not experience deterioration of the recorded picture quality. Up to 4 (for NVR-0204) or 8 (for NVR-0208) or 16 (for NVR-0216) cameras can be connected via a network and it is possible to record their camera pictures. It is possible to perform the settings or operate the NVR using a web browser installed on a PC connect to a network, or remote controller. Recorded video can be played back from remote site by a PC. Up to 4 PCs (web browsers) can access this unit concurrently and it is possible to perform the settings and operate this unit. The NVR is compatible with most major brand cameras and its ability to automatically search and find the available cameras on the network can greatly reduce the user effort when expanding the system.

- **Advance PTZ Control**
- **Various Types Event Alerts**
- **Pure Web Based Administration**
- **Linux-embedded Operating System**
- .. **Export Recorded Videos to AVI**
- **Compatible with Major Brand Cameras**
- **High Quality Live/Playback Videos**
- **LevelOne Smart Camera Search**

Hardware Illustration (Front)

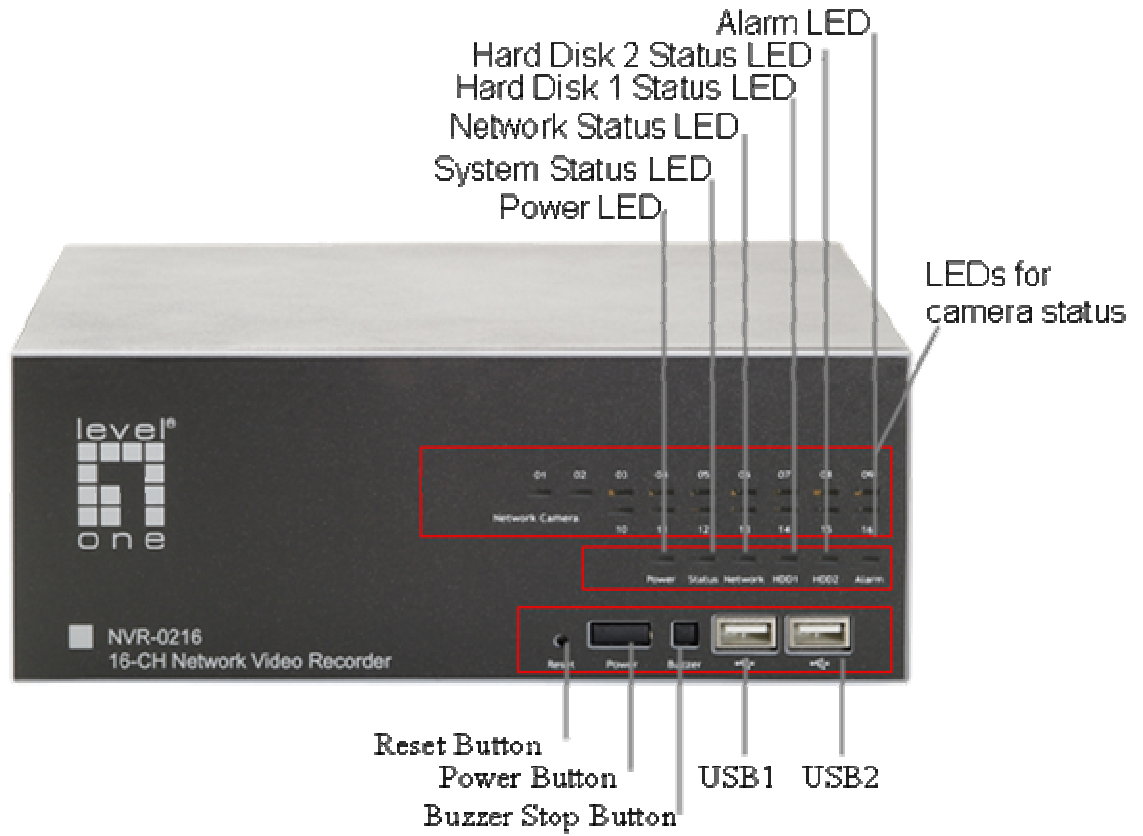

I/O Ports and RS-485 (Rear)

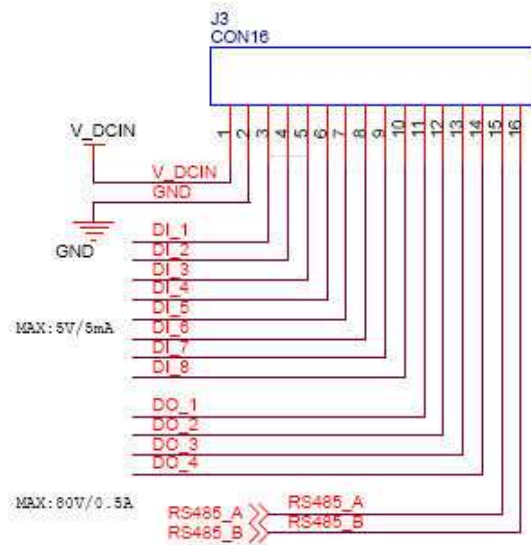

Pin	Signal
1	DCIN
2	GND
3 ~ 10	Alarm input
11	Out1
12	Out2
13	Out3
14	Out4
15	RS485+
16	RS485-

LEDs Definition



HDD x 2	Green	Solid green when the hard disk is mounted and being accessed
	Red	Solid red for disk fail
	Amber	Solid amber when disk is full Blinking when recycling
Network	Amber	Solid amber for activity on a 1G bps network.
	Green	Solid green for activity on a 10/100 Mbps network.
Status	Amber	Blinking during firmware upgrade
	Green	Shows solid green for normal operation. Blinking green when firmware upgrade is done
	Red	Flashes red for failed firmware upgrade.
Power	Green	Normal operation
	Red	System off (power adapter remains plugged in)
	Amber	Blinking amber indicating device is initializing
Alarm	Red	Blinking when an alarm occurs
	None	When alarm is reset

Camera LEDx16 (8 for NVR-0208, 4 for NVR-0204)	Green	Solid green, live connected with no event or recording activity
	Amber	Blinking amber, manual or event recording is being performed
	Amber	Solid amber, schedule or continuous recording is being performed
	Red	Recording is set but no video from camera

Install Hard Disk

Start by removing the screws on the side:



Push the top housing forward



Then lift it up

- The NVR supports SATA I or SATA II hard disks
- The NVR supports max. 1TB per hard disk and it supports total of 2 hard disks (2TB)

Remove the hard drive cover plate

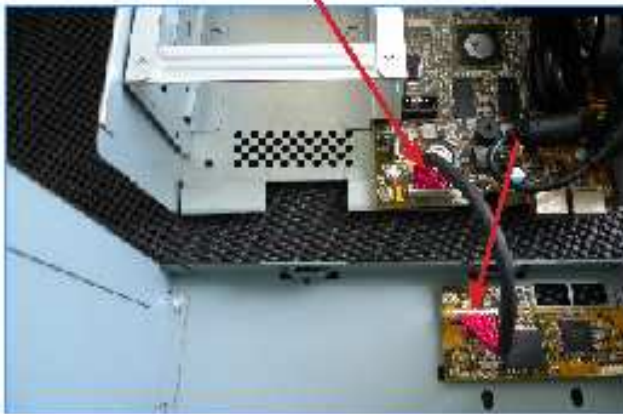

Pull out the hard drive tray holder



Place the hard drive on the tray and push it inward to secure the hard drive



Connect the SATA cable to the hard drive



Put the hard drive tray cover plate back

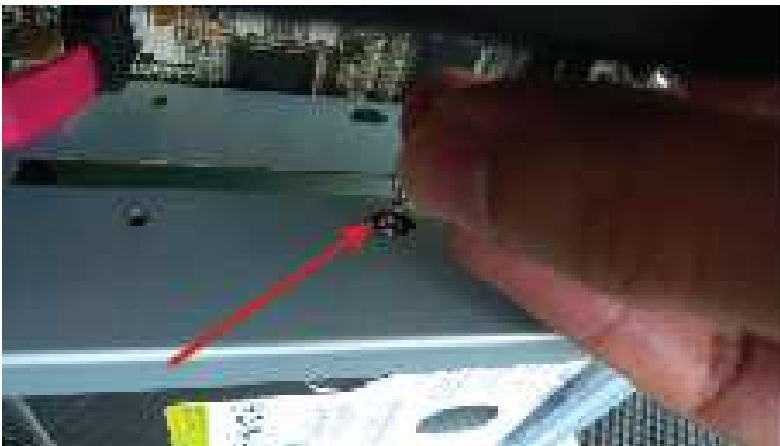

Place the top housing back and secure it with the bottom housing



Connect to the NVR

There are various ways you can connect to the NVR and below are the suggested methods for different network setup:

- The NVR is placed in a network with a DHCP server: Connect to the NVR by using **“Search NVR” Utility**
- The NVR is placed in a network without DHCP server (or you are connecting to it directly): **Access NVR with its default IP**

Use LevelOne Device Search Utility

If the NVR is placed in a corporate network or a local area network where a DHCP server is already presented, install the “LevelOne Device Search” utility on the CD from a computer that is on the same network and locate the NVR with its IP address that is assigned by the top-level DHCP server.

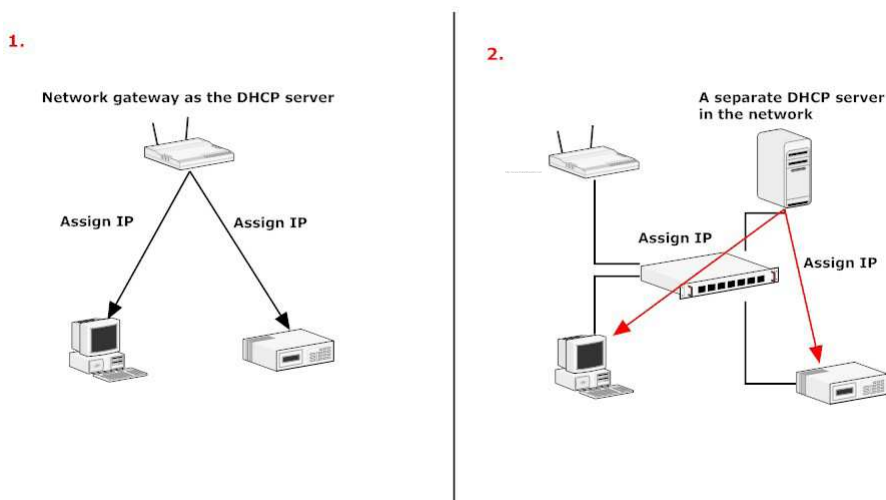

To begin, launch the “LevelOne Device Search” utility from the CD and proceed with the installation:

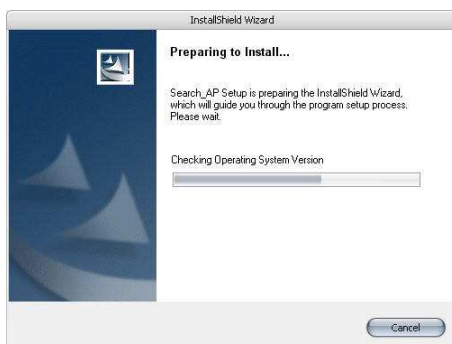

Once the installation is complete, check the “Launch the Search AP” option and click “Finish”:

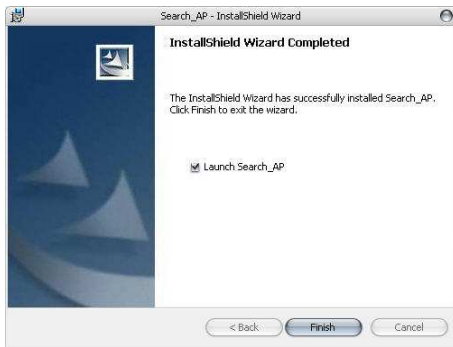

The search should start automatically and its status should be displayed:

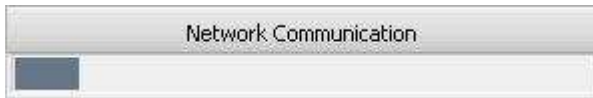

The NVR should be located and its IP address should be displayed: Double-click on it and the program should automatically access the NVR's web administration page from your default browser



You may change NVR's IP address by click on the button highlighted below.



You will be prompted for the NVR's login information before proceeding to change device's IP address.

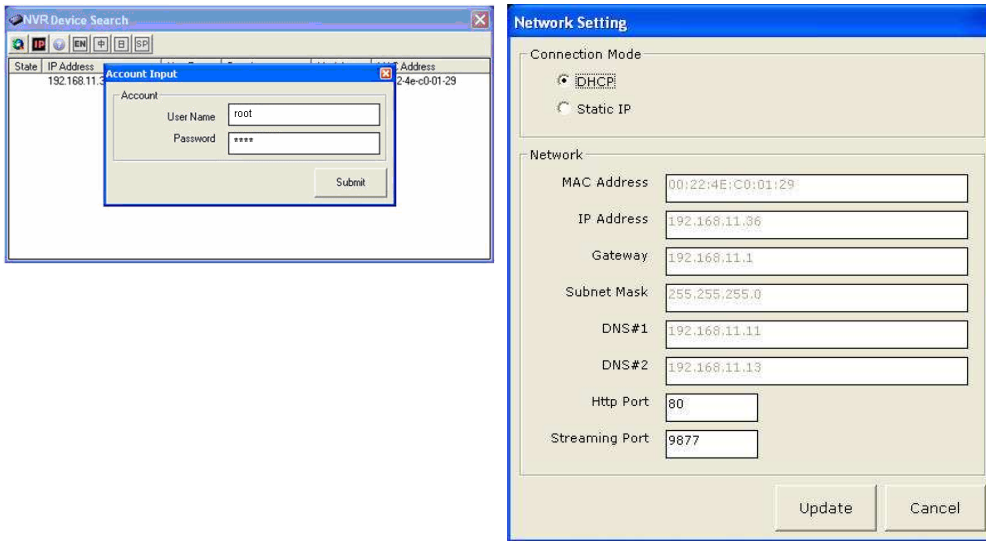

You may click on the button highlighted below to perform search again. Or double-click on any of the search results to access NVR's web administration page



perform search again

access NVR's web administration page

You should be prompted for the NVR's username and password. Enter its default username **"admin"** and password **"password"** and then click "OK" to enter the system



Please login

User Name (Default: root) :

Password (Default: root) :

Access NVR with its default IP address

The NVR comes with a pre-configured static IP “192.168.101.50”. However, it is only used when there is no DHCP server presented in the network. The NVR will turn on its DHCP server function and act as the DHCP server in the network. To connect to the NVR, use a PC that is on the same network over a switch or hub, or connect the PC directly to the NVR using a crossover CAT5 Ethernet cable.

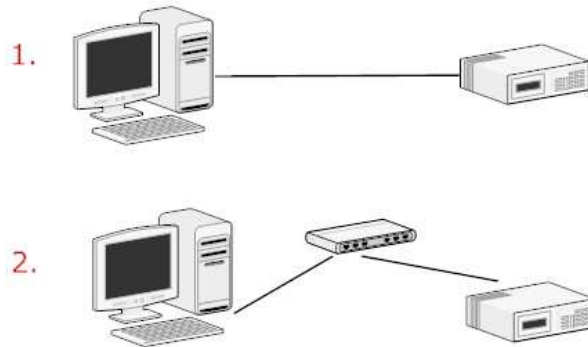

The PC that is connected directly to the NVR (or within the same local area network) should receive an IP from it. Simply access the NVR from your web browser with its IP address

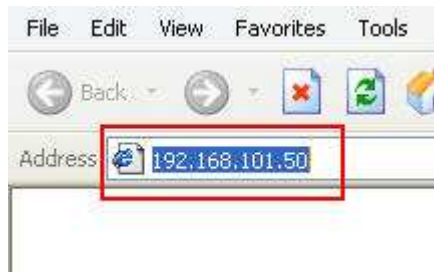

Again, you should be prompted for the username and password. Enter its default username “root” and password “root” and then click ”OK” to enter the system



Please login

User Name (Default: root):

Password (Default: root):

1. Live View NVR-0216



NVR-0208

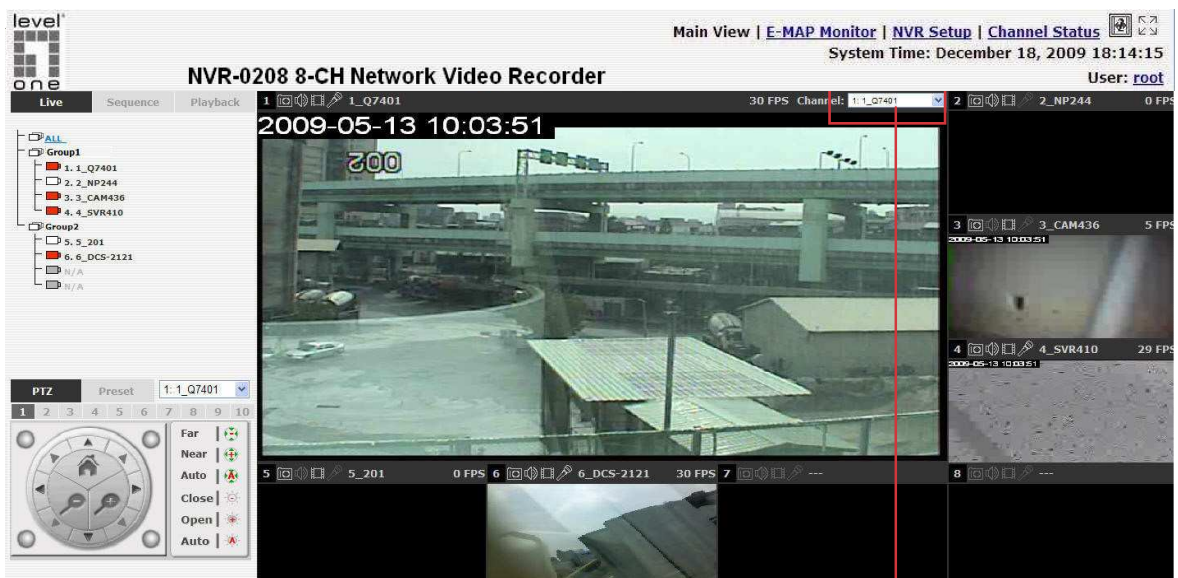

The 8 channel NVR comes with an 8-video split window view with one video displays on a larger window. Select a channel from the drop-down menu to display its video on the larger split window. You can also double-click on any of the smaller

NVR-0204

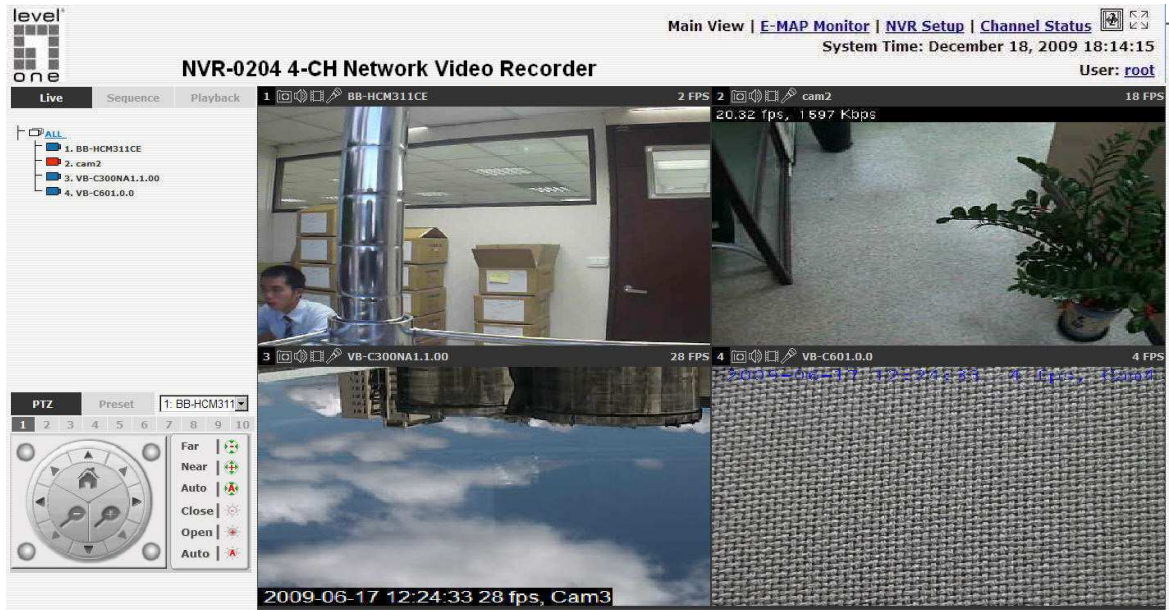

The “Live View” page provides the following functions:

- . Retrieve camera's video stream
- . Retrieve camera's status
- . Perform Live Sequence Viewing
- . PTZ Control
- . Perform PTZ Preset Sequence viewing
- . Perform manual recording
- . Take snapshot
- . Receive audio of a video stream
- . Send audio
- . Control “Buzzer”
- . Change web UI display language

1.1 Retrieve camera's video stream

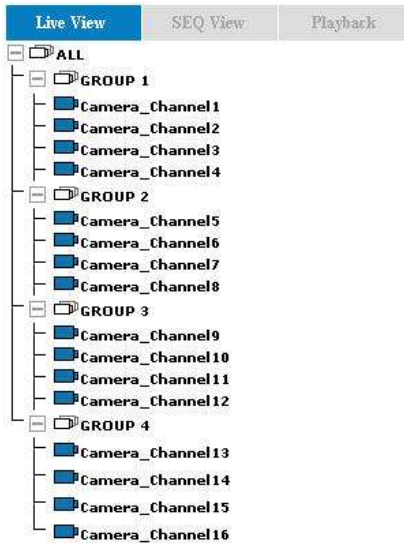

The camera list is expanded and displayed on the Live View page.

- Click “All” to display videos in the 8-video mode (NVR-0208) or 16-video mode (NVR-0216)
- Click on a “Group” (ex. Group 1) to display videos from cameras under that group in quad view
- Click on any camera to display video in single-view mode

1.2 Retrieve camera's status

The camera list can show each camera's current status. Each status is represented with different colors and their meanings are explained on the left

 Camera is connected

 Camera is NOT connected

 Camera is current performing recording

1.3 Perform Sequence Viewing

Sequence view is a function that allows you to view multiple video streams from certain cameras in sequence automatically without having to select them one by one.

To perform sequence view, select “SEQ View” from the upper-left hand corner



Next, select one or more camera(s) or camera group(s) for sequence viewing



Then select dwell interval from the drop-down menu

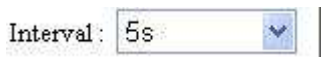

Finally click “Start” to start sequence viewing

** Click “All Channels” to quickly select all available channels and start sequence view in single-view mode.*

Click “All Groups” to quick select all available groups and start sequence view in quad-view mode

Or simply select the desired channels and press “Start” to start sequence view

The “All Group” button is not available in 4Ch NVR as it only has one group

1.4 PTZ Control

PTZ control provides functions to pan, tilt, zoom a PTZ camera as well as the ability to adjust camera focus and iris



Camera(s) that are currently being selected for live viewing will be listed in the PTZ drop-down menu. Simply select a camera then use the PTZ control panel to control the camera



The bar shown below allows you to control the pan/tilt speed



1.5 Perform PTZ Preset Viewing

There are three functions provided in the "Preset" section:

- Perform preset point viewing of a particular camera
- Auto pan a particular camera
- Perform preset point sequence viewing

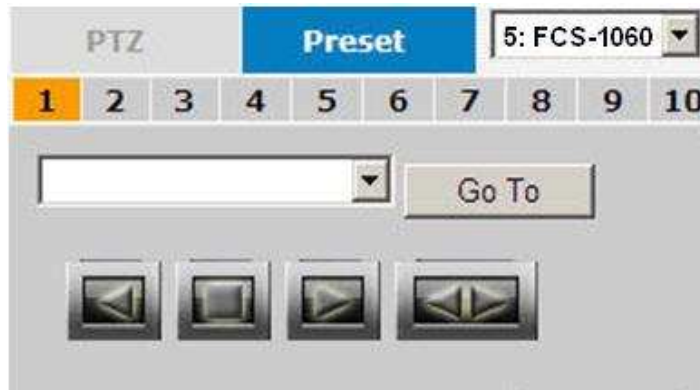

Preset Point Viewing

Start by selecting a PTZ camera from the drop-down list:



Its available PTZ preset points will be listed in the drop-down list shown below:



Select a preset position from the drop-down list and click "Go to" to move the live view to that position

Auto Pan Viewing

Start by selecting a PTZ camera from the drop-down list:



Use the Auto Pan Control buttons to pan right, left and stop auto pan

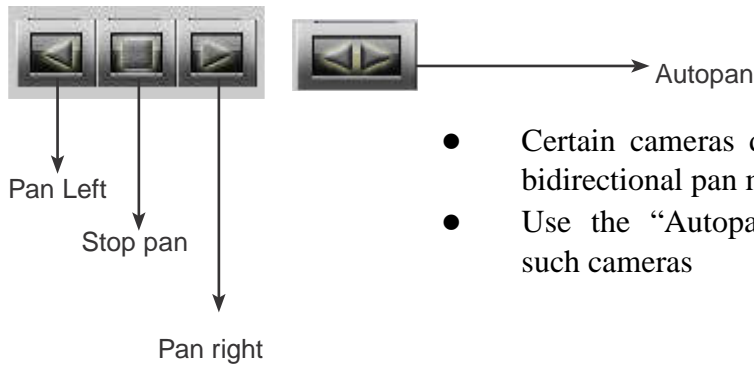

- Certain cameras do not support bidirectional pan movements.
- Use the “Autopan” button for such cameras





Preset Point Sequence Viewing

This function allows you to view multiple preset points' videos of a camera without having to select them one by one. Once you have defined the preferred preset points in “**Camera Configuration**” >> “**PTZ Preset Sequence**” under the “**Setup**” menu, click “Start” here and the recorder will begin to display videos from those preset points in sequence automatically until you click “Stop”

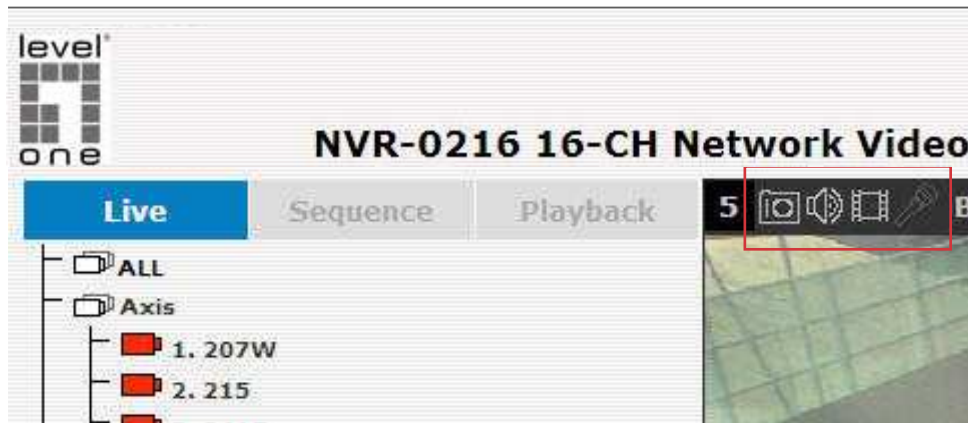
1.6 Live Video Control Buttons



Each live video window comes with control buttons with functions described below:



-  Take a snapshot of a live video
-  Turn on/off audio of a live video
-  Start/stop recording of a live video (manual recording) 

Audio post function



-  Full screen view of a live video
-  Display video in its original ratio

Take a snapshot of a live video

To take a snapshot of a live video, click the  button and the snapshot of the video will be displayed in a pop up window shown like below

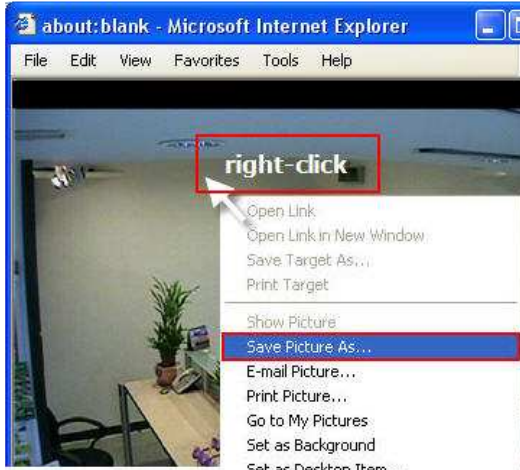

Right-click anywhere on the image and select “Save Image as” from the pull-down menu

In the pop up dialog, name the image file and choose which directory the image will be saved to and click “Save”

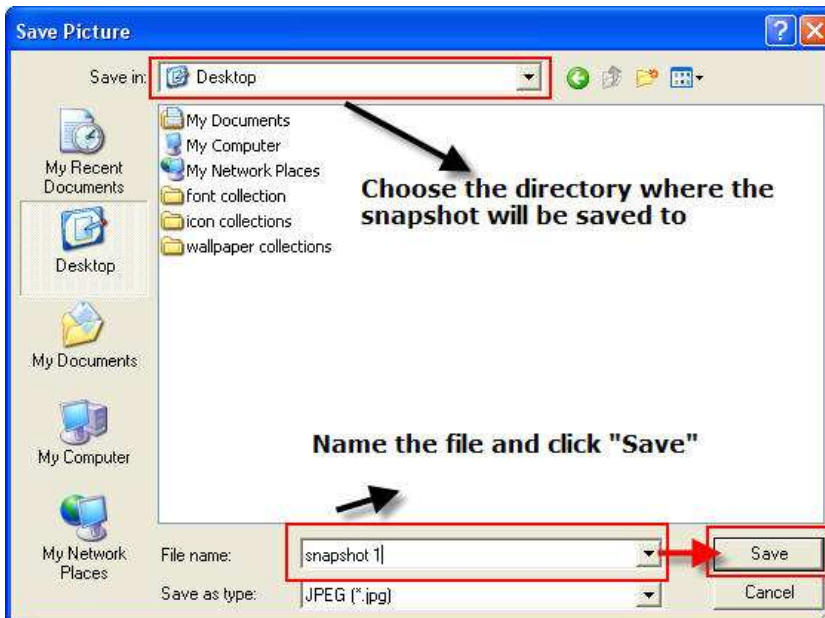

Full Screen View of a Live Video

To view a video in full screen, click the  button. To exit full screen video, double-click anywhere on the video.

Turn On/Off Audio of a Live Video

You can retrieve audio from a particular camera. Simply click the  button to do so.

The button will show in different color once the audio is turned on.  Click on it again to turn off audio.



You may only turn on audio once channel at a time

Start/Stop Recording of a Live Video

You can manually start or stop recording of a live video by using the  button.

The button will show in different color once the recording is started manually.  Click on it again to stop recording.

Audio post

This function allows user to speak from a PC through a microphone and the audio can be played at the camera side if it has a speaker connected to it.

1.7 Change Web UI Display Language

You can change the web UI display language from the current login username link located at the upper-right hand corner. Click on the link opens up a new window which displays detail information about the user as well as a drop-down menu which lets you change the display language.

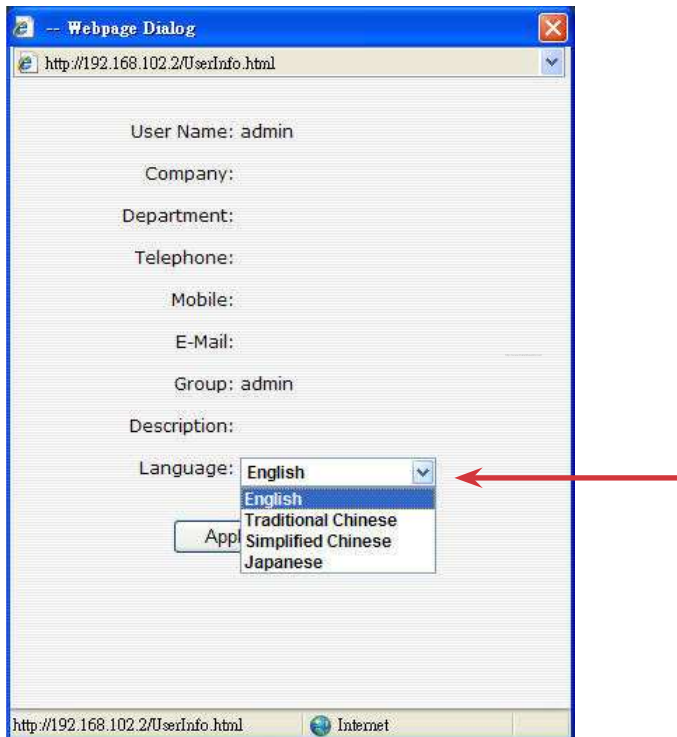

2. Playback

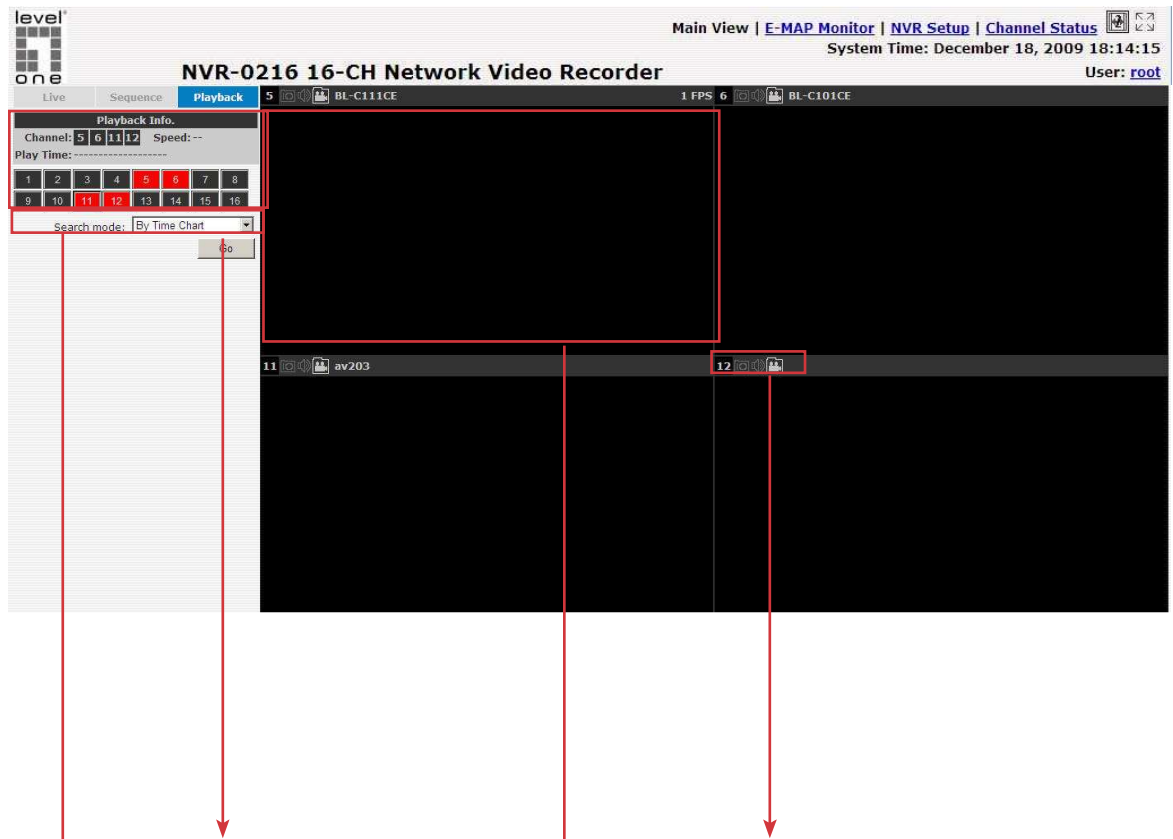

Methods to search playback

Playback video control buttons

Channels to be played back

Playback video

Playback is a function that allows you to play one or more videos that were previously recorded by a chosen recording method or due to an event trigger. The NVR offers synchronized playback from up to 4 channels and various types of search methods are provided to help you find the footage you need quickly.

You can turn on or off the audio of a recorded video at your choice if audio was also recorded during the recording of the video.

Playback video can be viewed in full screen and snapshots can be taken and saved during a video playback.

2.1 Methods to Search Playback Videos

The NVR offers three methods to quickly help users find videos that were previously recorded:

- Search by time: *Specify a time range and search videos recorded within that range*
- Search by event: *Find videos that were recorded due to event triggers*
- Play by start time: *Enter a specific time a video was recorded to start playing back the video*

Search by time chart

- Start by selecting which channel(s) you would like to perform a search on:

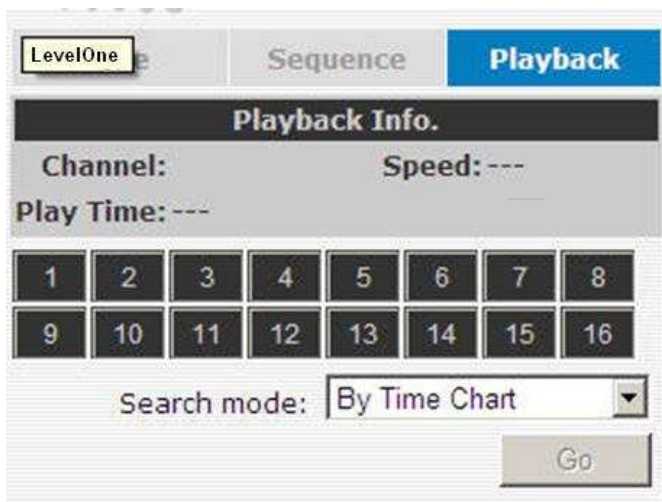

* Selected channels will be marked in red



- Select “Search by time chart” from the “Search Method” drop-down list and click “Go” to start the search:



- Click on the cell box again will start playing back the videos if you have reached the end of search results:



- Videos found from other cameras that were recorded at the same time will also be played.

Search by event

- Start by selecting which channel(s) you would like to perform a search on:

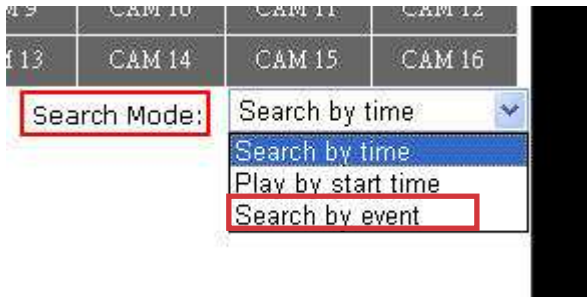

* Selected channels will be marked in red

LIVE VIEW	SEQ VIEW	Playback	
1. 21	2. 21-MPEG	3. 20	4. 20-MPEG
5. 23	6. 23-MPEG	7. 24	8. 24-MPEG
9. Camera_	10. Camera	11. 27	12. 27-H26
13. Camera	14. 26-MPE	15. 28 Axi	16. 28 Axi

- Select "Search by event" from the "Search Method" drop-down list and click "Go" to start the search:
- Results will then be listed like what is shown below (displays the oldest record top down). Click on a particular result to start the playback:



* You can click "Next Search" to display the next 15 results.

- You may also specify a new start time to search and display results from then on. You can restrict the number of results to be displayed at once (max. 30) and perform the search again



Play by specific time

If you know when a recording was taken place, you may choose the "Play by start time" from the "Search Method" drop-down list



Then you will be prompted to enter a specific time and date for the recorded video.

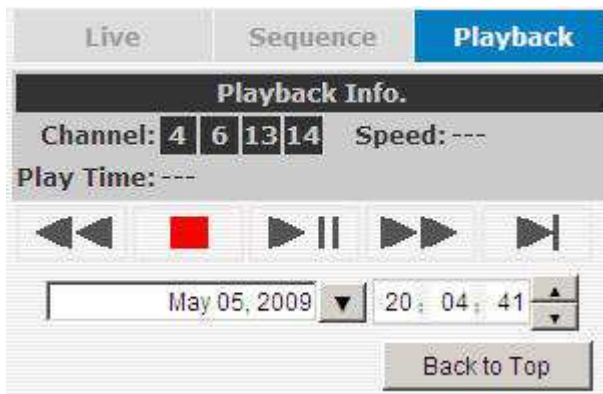

Use the  button to select month, date, and year

Search by event (Most Recent)

This function quickly displays the most recent event recordings from the selected channels, displaying the most recent result top down. You may click "Update" to update the list to display the most recent result

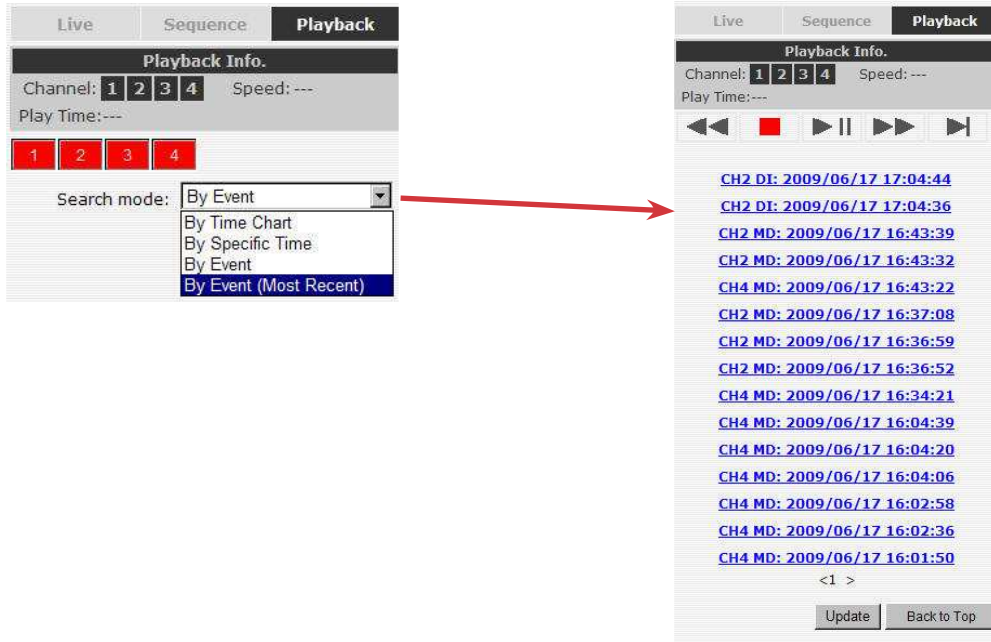

2.2 Export Playback Videos to AVI Files

User can export the recorded playback videos stored on NVR-0216 to a local computer and save them in AVI file format. The files can then be played on the PC by a 3rd party media player such as VLC player or Windows Media player.

Once you locate the recorded videos with steps described in the previous section, hit the “Export AVI” button on a video window of the video you wish to export.

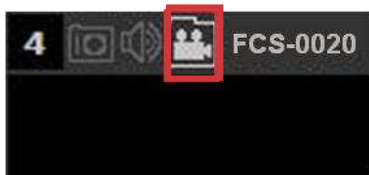

A new dialog will pop up and allows you to specify the time frame (or length) of the video you wish to export

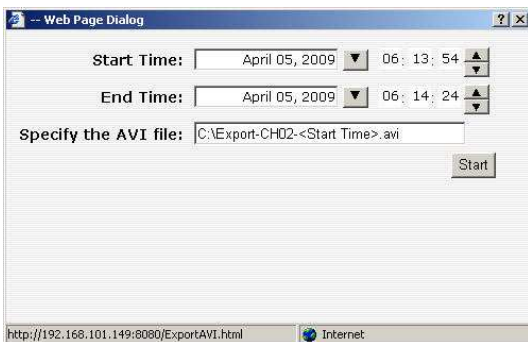

Click the  button to pull down the calendar to help you specify the month, date and the year



Specify the starting and ending hours of the video by entering numbers in the text boxes

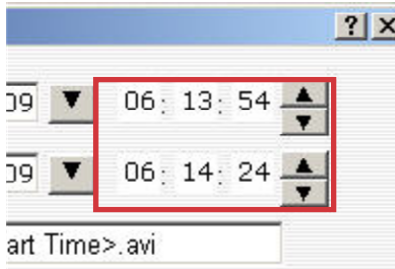

Hit the “Start” button to start exporting. The file will be automatically named and saved under the C:\ partition

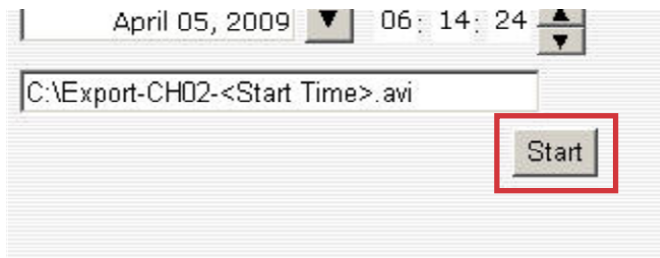

You will be notified once the process is completed successfully

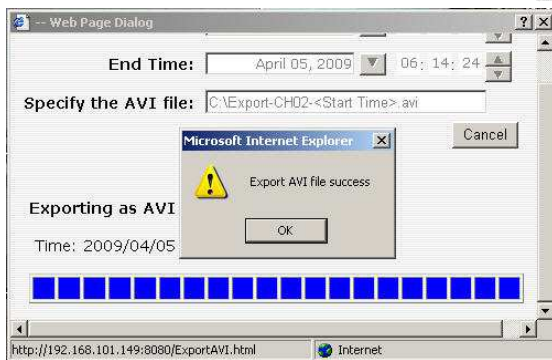

The exported AVI file will be saved under the C partition

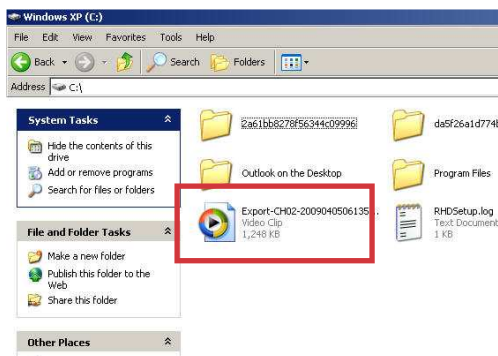

** ffdshow is required in order to play the exported AVI file with Windows Media Player. You can get it at “<http://sourceforge.net/projects/ffdshow-tryout/>” to download the “ffdshow_beta6_rev2527_20081219.exe”*

3. System Setup

3.1 System Configurations

The “System Configurations” page provides users options to setup the device quickly and properly. After properly configuring all settings in all the sub-pages, users should expect a fully working network video recorder that is ready to manage cameras on the network. We will start by configuring its network settings to make sure it works correctly in your network. Next, we will help you adjust the system time so videos will be recorder with correct timestamp. To better secure the system for unwanted disturbance, we will guide you on setting up user’s account and privileges to prevent settings gets altered by users other than the system administrator. Lastly, we will tell you what you should expect after installing a hard disk and how to prepare the hard disk for the video recording.

3.1.1 Network Settings

The screenshot shows the web interface for a LevelOne NVR-0216 16-CH Network Video Recorder. The page title is "NVR-0216 16-CH Network Video Recorder". The system time is "December 18, 2009 18:14:15" and the user is "root". The interface is divided into a left sidebar and a main content area. The sidebar has a "Setup" menu with the following items: System Configuration (expanded), Network Setup, Time and Date, Users Account, Group Privilege, and Disk Setup. Under "System Configuration", there are sub-items for Channel Configuration, Event Configuration, Recording Configuration, and System Options. The main content area is titled "Network Setting" and contains the following fields and controls: Connection Type (DHCP), IP Address (192.168.102.2), Subnet Mask (255.255.252.0), Gateway (192.168.101.1), DNS1 (192.168.11.11), DNS2 (192.168.11.13), HTTP Port (80), Streaming Port (9877), and UPnP Port Forwarding (unchecked) with an External Port of 6000. There are "Test" and "Force Change" buttons next to the External Port field. Below the "Network Setting" section is an "Optional Setting" section with a "Device Name" field containing "tst" and an "Apply" button.

You need to adjust settings in this page for the device to work properly in your network. It is critical that settings here are configured correctly based on your network configurations so that the recorder can be administered through the local area network and cameras can be connected from it.

By default, the recorder is set to obtain IP address from DHCP server, it should be sufficient in most network environments, and most likely you should not need to alter anything in this page. To locate the recorder, simply use the LevelOne IP Utility with steps described in page 12.

If you wish to set the recorder to use a static IP address in your local area network,

1. Choose "Static IP" from the "Connection Type" drop-down menu
2. Enter the IP address, subnet mask, default gateway address and DNS server address for the recorder
3. Enable "DHCP Server" under "DHCP Server" if you wish to use the recorder as a DHCP server, or leave it disabled if there is already a DHCP server in the network 
4. Click Apply for the settings to take effect

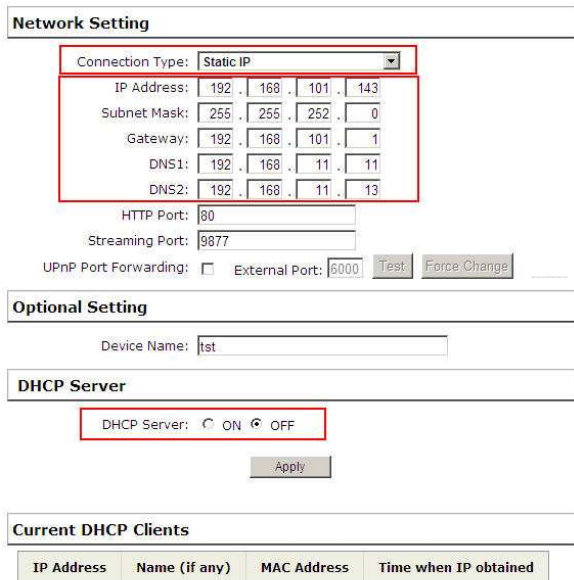

Network Setting

Connection Type: **Static IP**

IP Address: 192 . 168 . 101 . 143
Subnet Mask: 255 . 255 . 252 . 0
Gateway: 192 . 168 . 101 . 1
DNS1: 192 . 168 . 11 . 11
DNS2: 192 . 168 . 11 . 13

HTTP Port: 80
Streaming Port: 9877
UPnP Port Forwarding: External Port: 6000

Optional Setting

Device Name: tst

DHCP Server

DHCP Server: ON OFF

Current DHCP Clients

IP Address	Name (if any)	MAC Address	Time when IP obtained
------------	---------------	-------------	-----------------------



The recorder can detect the presence of a DHCP server upon startup. It sets itself to use static IP address if there is no DHCP server currently presented in the network.

Its DHCP server function is also turned on at the same time to assign IP addresses to cameras that are later connected to the network. You can manually turn off the DHCP server function if you wish to use a separate DHCP server.



Change the recorder's IP address would require the recorder to restart. Restart the device under "system Options" >> "Maintenance" for the settings to take effect.

3.1.2 Time and Date

Setup

- System Configuration
 - Network Setup
 - Time and Date**
 - Users Account
 - Group Privilege
 - Disk Setup
- Channel Configuration
- Event Configuration
- Recording Configuration
- System Options

Time and Date Setting

Time Zone: GMT+08 (Beijing, Hong Kong, Shanghai, Taipei) Summer time

Manual

Year: 2009 Month: 05 date: 06
Hour: 10 Minute: 24 Second: 29

Sync with NTP Server

NTP Server: ntp.ucsd.edu
Update Interval: 24 hr

Sync with PC May 06, 2009 10:24:29

Apply

Set the time and date by selecting the time zone according to your location. It is imperative that you set the recorder's time correctly to avoid the following errors:

- Incorrect display time for playback videos
- Inconsistent display time of event logs and when they actually occur

After selecting the time zone, choose an option below to set the recorder time

- **Manual** – Use the drop-down list and configure the time manually
- **Sync with NTP server** – enter the hostname or IP address of a valid NTP server and set how often the recorder should synchronize the time with the recorder by using the “Update interval” drop-down menu
- **Sync with PC** – Check this option to synchronize the recorder time with the PC that you are currently using to access the recorder

3.1.3 User Account

The recorder can be accessed by multiple users simultaneously. You can add, remove, and edit users by using options provided in this page to keep user information organized. Each recorder comes with a built-in “admin” account with password “password”. It’s highly recommended to change the password upon your initial login.

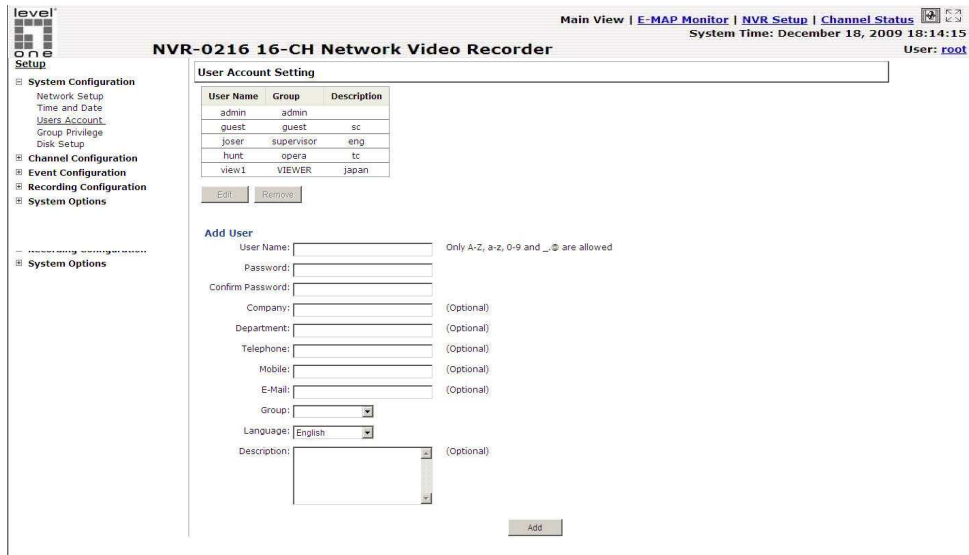

To change the password of the “admin” account:

1. Click and highlight the “admin” account in the account list and click “Edit”
2. Its information should be displayed in “User Account Information”
3. Enter a new password in the “Password” field and enter it again “Confirm Password”

To add a new user:

- Enter a username and password in “User Account Information”. All other fields are optional for your own reference.
- Select a group from the “Group” drop-down menu to assign the new user to a particular group
- Enter a short description for the account if you wish
- Click “Apply” to finish configuration

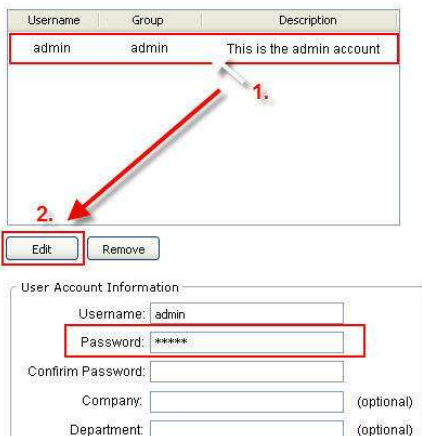

3.1.4 Group Privilege

Group Privilege is where you can create multiple customized access policies for situations if you need the recorder to be accessed by users other than the administrator. You can do so by creating a group, and then remove access privileges for certain configuration pages or cameras. Users that are created and assigned to this group will have limited access instead of full administration rights.

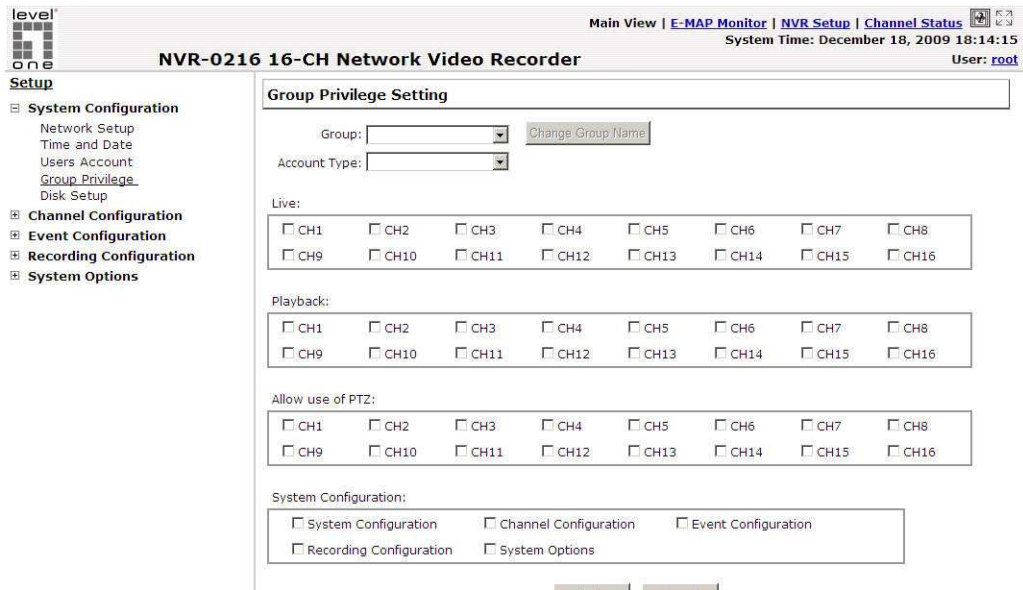

The recorder comes with seven built-in groups and five built-in privilege profiles, except the “admin” and the “guest” accounts; the other five groups are fully customizable or you can simply assign a group with one of the default privilege profiles. You can, however, assign more than one users to the “admin” account if you wish to do so. The guest account comes with a “view-only” privilege in the “Live View” page, and users in this group do not have the power to make any changes in the “Live View” page or have access to pages other than the “Live View” page.

To create a group, select a group from the “Group” drop-down



You can change the group name by clicking the “Change Group Name” button. A text box will be displayed for you to enter the new group

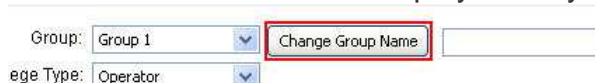

Choose what type of privilege you would like this group to have from the "Privilege Type" drop-down menu

Group:
Privilege Type:

Its access privilege will then be displayed. You can alter its settings by allowing or denying access to other cameras using the checkboxes instead of accepting the defaults

Group Privilege Setting

Group:
Account Type:

Live:

<input type="checkbox"/> CH1	<input checked="" type="checkbox"/> CH2	<input checked="" type="checkbox"/> CH3	<input checked="" type="checkbox"/> CH4	<input checked="" type="checkbox"/> CH5	<input checked="" type="checkbox"/> CH6	<input checked="" type="checkbox"/> CH7	<input checked="" type="checkbox"/> CH8
<input checked="" type="checkbox"/> CH9	<input checked="" type="checkbox"/> CH10	<input checked="" type="checkbox"/> CH11	<input checked="" type="checkbox"/> CH12	<input checked="" type="checkbox"/> CH13	<input checked="" type="checkbox"/> CH14	<input checked="" type="checkbox"/> CH15	<input type="checkbox"/> CH16

Playback:

<input type="checkbox"/> CH1	<input checked="" type="checkbox"/> CH2	<input checked="" type="checkbox"/> CH3	<input checked="" type="checkbox"/> CH4	<input checked="" type="checkbox"/> CH5	<input checked="" type="checkbox"/> CH6	<input checked="" type="checkbox"/> CH7	<input checked="" type="checkbox"/> CH8
<input checked="" type="checkbox"/> CH9	<input checked="" type="checkbox"/> CH10	<input checked="" type="checkbox"/> CH11	<input checked="" type="checkbox"/> CH12	<input checked="" type="checkbox"/> CH13	<input checked="" type="checkbox"/> CH14	<input checked="" type="checkbox"/> CH15	<input type="checkbox"/> CH16

Allow use of PTZ:

<input type="checkbox"/> CH1	<input checked="" type="checkbox"/> CH2	<input checked="" type="checkbox"/> CH3	<input checked="" type="checkbox"/> CH4	<input checked="" type="checkbox"/> CH5	<input checked="" type="checkbox"/> CH6	<input checked="" type="checkbox"/> CH7	<input checked="" type="checkbox"/> CH8
<input checked="" type="checkbox"/> CH9	<input checked="" type="checkbox"/> CH10	<input checked="" type="checkbox"/> CH11	<input checked="" type="checkbox"/> CH12	<input checked="" type="checkbox"/> CH13	<input checked="" type="checkbox"/> CH14	<input checked="" type="checkbox"/> CH15	<input type="checkbox"/> CH16

System Configuration:

<input checked="" type="checkbox"/> System Configuration	<input checked="" type="checkbox"/> Channel Configuration	<input type="checkbox"/> Event Configuration
<input type="checkbox"/> ...	<input type="checkbox"/> ...	

3.1.5 Disk Setup

Once you install a hard disk to the recorder, you would need to initialize it so that it can be ready for recording. You can obtain basic information about the disk you installed in this page

To initialize it, simply click the “Format” button

- Setup**
- [-] **System Configuration**
 - Network Setup
 - Time and Date
 - Users Account
 - Group Privilege
 - Disk Setup
- [+] **Channel Configuration**
- [+] **Event Configuration**
- [+] **Recording Configuration**
- [+] **System Options**

Hard Disk Setting				
Disk ID	Disk Type	Capacity	Disk Status	Format
1	Internal	445GB	Online	Format
2	Internal	142GB	Online	Format

You can also connect external USB thumb drive to the recorder for firmware upgrade.

 For instructions to install a hard disk to the recorder, refer to page 9

 To obtain detail information about the disk, go to “System Options” >> “Disk Status”

3.2 Channel Configurations

3.2.1 Add a Camera

The NVR provides two options for adding a new camera. Users have the option to let the recorder automatically find the cameras or it is possible to enter camera's information and add it manually.

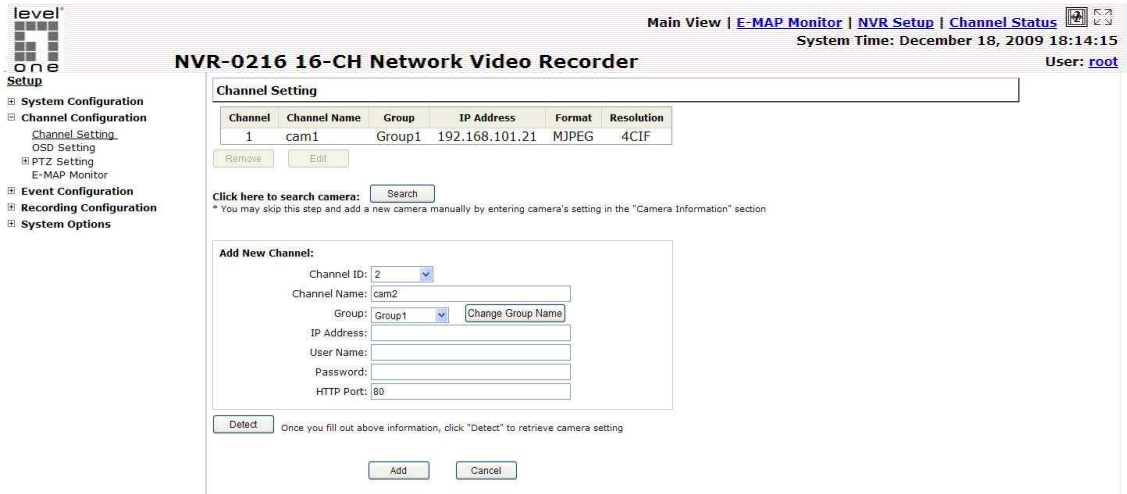

Automatic Search:

1. Click the “Search” button to perform the camera search. You should be prompted to install Active Control component in order for the search to function properly. Go ahead and click “Install”



2. After that, the search should begin and its status should be displayed:



3. Found cameras should be listed and simply select a camera from the list and press "Configure"

Click here to search camera:
* You may skip this step and add a new camera manually by entering camera's setting in the "Camera Information"

Brand	Model	IP Address	HTTP Port	Installed
LevelOne	FCS-0020	192.168.11.26	80	

select a camera from search result and click "Configure" to configure setting below.

4. Its corresponding information should be displayed in the "Camera Information" section. Enter its username and password and select the channel ID and name the camera.

Add New Channel:

Channel ID:

Channel Name:

Group:

IP Address:

User Name:

Password:

HTTP Port:

5. Click on "Detect" to establish connection between the recorder and the camera. If connection establishes successfully, camera's detailed information should be polled and displayed as below

Once you fill out above information, click "Detect" to retrieve camera setting.

Additional Camera Information

Video Port:

Format:

Resolution:

Quality:

Record: Continuous

6. Adjust its video format, frame rate, resolution or bitrate...etc if you wish. You can also click on the "Preview" to preview the live video of the camera.

Click "Add" to finish adding the camera

 If cameras are marked with "*" in the search result, it means those cameras are already configured and connected to NVR-0216.

and add a new camera by manually entering camera's setting in the "Camera Information" page.

	IP Address	HTTP Port	Installed
	192.168.101.40	80	
	192.168.101.42	80	
	192.168.101.41	80	
	192.168.101.47	80	
	192.168.101.43	80	
	192.168.101.23	80	*
	192.168.101.46	80	

Add a camera manually

Simply follow the instruction described above but instead of using the "Search" function, enter the camera's IP address and credential in the "Camera Information" manually, then follow step 5 ~ 6 described above.

Add New Channel:

2. Channel ID:

Channel Name:

Group:

IP Address: 1.

User Name:

Password:

HTTP Port:

Once you fill out above information, click "Detect" to retrieve camera setting.

Enter manually

3.2.2 OSD Settings

The OSD (On Screen Display) allows users to add informational text message and embed it onto the video. By default, this function is turned off. To add texts to one or more videos,

1. Select a camera you would like to add text to and choose “Display OSD”

OSD Settings

Camera: Camera 1

Do Not Display OSD

Display OSD

2. Choose one or more display options if you would also like the recorder to automatically embed the system time or the frame rate for you. Or simply choose to display a custom message of your own

Text Display Options

Show Time

Show FPS

Show Text: (Max. 32 char.)

3. Next, define where the text will be displayed by either entering an X/Y coordinate or use the system pre-defined position from the drop-down menu

OSD Position

Display OSD at the coordinates X: Y:

Display OSD at: Upper-left

4. Click on the “Preview” button to see the preview of your setting and click “Apply” to save the configuration



The texts can be further adjusted with changes to different size, color or font so they can be more visible on the video

Customize OSD Text and Background

Text Size: Auto Self-defined 9

Text Color: Customize

Font: Arial

Text Background Color: Auto Self-defined Customize

3.2.3 PTZ Preset Settings

The recorder supports PTZ cameras and can set multiple preset points or retrieve and manage preset points that are set in the camera. This is helpful if you need to monitor multiple spots in one area from a particular camera.

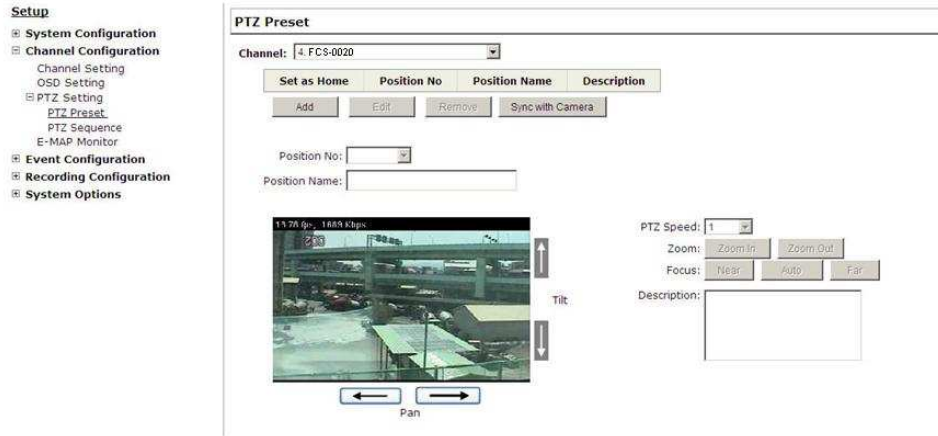

1. To set up PTZ preset points, select a camera from the “Camera” drop-down menu and click “Add”



2. Select a position number for the preset point from the “Position Number” drop-down menu and fill in a name in the “Position Name” field for easier identification

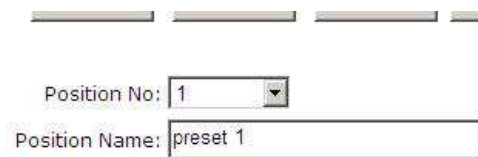

3. Use the PTZ control provided in the configuration page to set the preset point and set the position as the “HOME” position if you wish.

4. Click “Apply” to save the configuration.

3.2.4 PTZ Preset Sequence

Once you have multiple preset points defined for a camera, it is convenient for monitoring to set up the sequencing viewing among those preset point and let the recorder automatically switch between them for you.

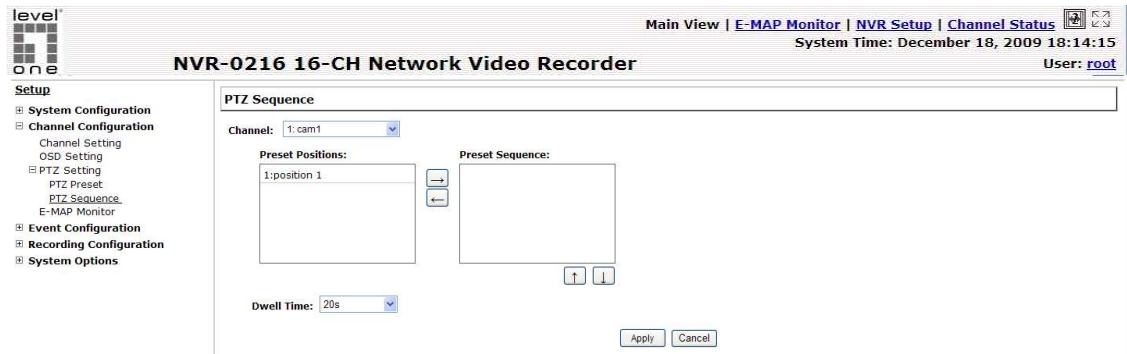

To configure preset sequence for a camera,” select a camera from the “Camera” drop-down menu

The available preset points should be listed in “Camera Presets” section

Pick the ones you like for sequence viewing and press the “->” button to move them to the “Adjust Position” section, then use the up and down buttons to adjust their sequences

Finally, select a dwell time from the drop-down menu and click “apply” to save the configuration

- To start preset sequence viewing, check page 20 for instructions

3.2.5 E-Map Monitor

E-Map monitor is a function that alerts users whenever there is an event triggered (e.g. motion detected) from a camera with a geographical perspective. With this function, users can quickly identify which camera has detected an unusual event and where this event is happening. This function works by incorporating the event detection function as well as the recording function, which, as a result, helps users take all the necessary actions when an unusual event occurs.

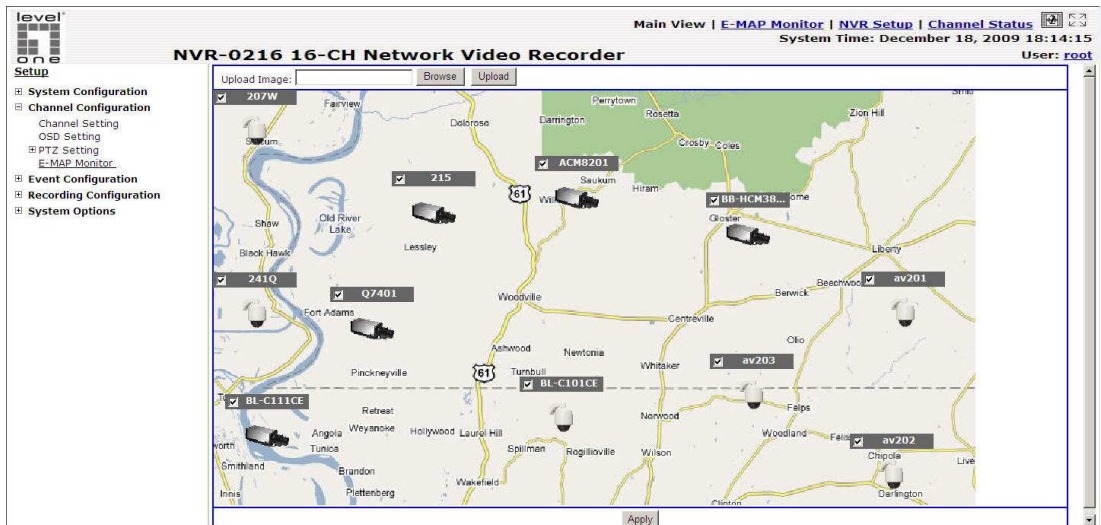

To replace the map, click “Browse” button to locate the new map image file from the local PC and then click “Upload”

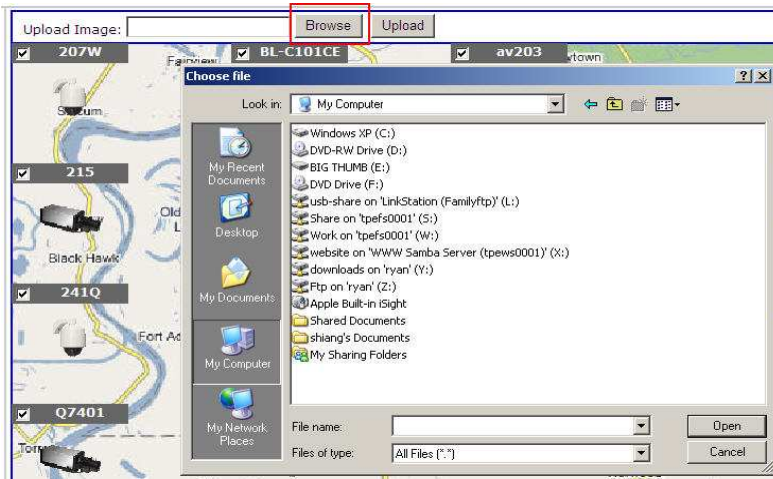

Then click and drag the camera icon to move the camera to define its location.



Access the E-Map Monitor page from the upper-right hand corner menu

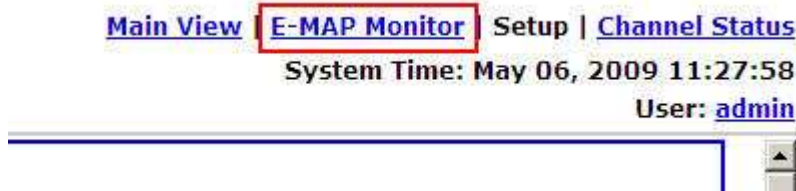

When the NVR receives an event triggered from any of the cameras, their videos will be displayed on the E-Map and you can double-click on the video to enlarge it



3.3 Event Configurations

The “Event Configurations” section allows users to define conditions that constitute an event, its corresponding trigger action and when it will be triggered. Such setting can reduce the management overhead and notify the administrator only when it’s necessary.

3.3.1 General Settings

The general settings section can help you quickly configure when an event is triggered, how often events are triggered and the corresponding actions when events are triggered.

The screenshot shows the web interface for the NVR-0216 16-CH Network Video Recorder. The top navigation bar includes links for Main View, E-MAP Monitor, NVR Setup, and Channel Status. The system time is December 18, 2009 18:14:15, and the user is root. The left sidebar shows a menu with categories like System Configurations, Camera Configurations, Event Configurations (selected), Recording Configurations, and System Options. The main content area is titled 'General Settings' and contains three sections: 'Event Trigger Duration' with radio buttons for 'Always' and 'Only During' (with checkboxes for days Mon-Sun and time fields for Start and End times), 'Event Trigger Interval' with a text input for 'Interval' (set to 5) and a note '(5~ 86400)', and 'Trigger Action' with checkboxes for 'Send Image' (set to 1 frame) and 'Send Message' (with a preview window showing a sample message: 'The message was sent from SVR-116 This system has detected an unusual event'). There are also optional fields for Subject and File Name, and 'Apply' and 'Cancel' buttons at the bottom.

Start the event configuration by defining the general settings:

Define when an event will be triggered

- Choose “Always” or “Only during...” under “Event Trigger Duration”
- For the “Only during...” option, choose the days by using the check-box and then define the time range in those days in the “Start Time” and “End Time” fields that you would like the event trigger function to be enabled.

How often an event is triggered

- Set a time interval under “Event Trigger Interval” to define how often events are triggered

Trigger action

Now that you have the event trigger duration and interval defined, choose what action to be taken during an event trigger:

- You can choose to have the recorder send out the first few frames of the video recorder upon an event is triggered
- You can also choose to have the recorder send out a warning message in e-mail or in txt file format and upload it to a destined FTP server

3.3.2 I/O Settings



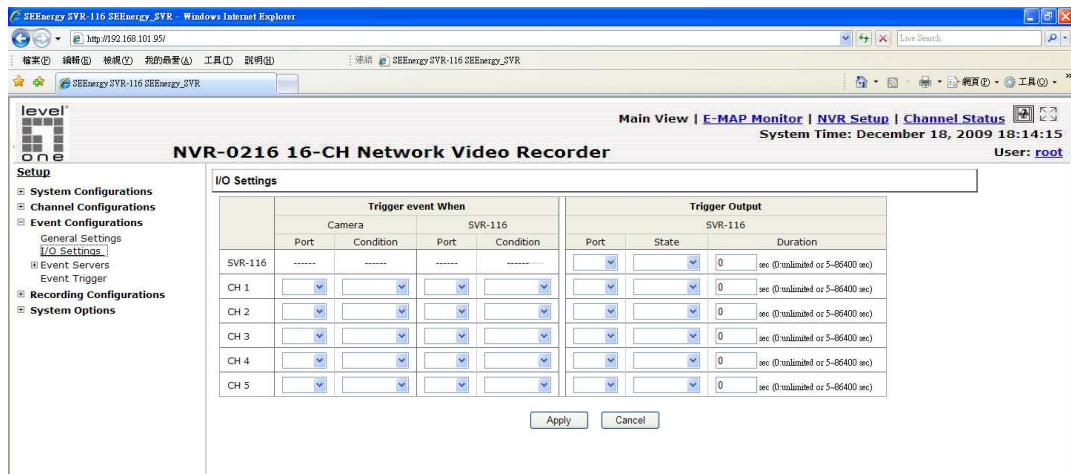

This function allows users to manage camera's digital input and output ports right from the recorder. You can setup the recorder to receive triggers from a particular camera's input port and trigger a device, such as an alarm that is connected to the recorder or camera's output port. Cameras that do not have built-in digital input/output port can also be configured to pair with the recorder's DI/DO ports.



1. For cameras that come with physical digital input ports, their ports will be listed in the far left drop-down menu.
2. Pick the desired channel for I/O mapping, and then select the camera's input port from the drop-down menu.
3. Select the trigger condition from the "Condition" drop-down menu.
4. Select the recorder's input port if you would also like to use the recorder's input port for event trigger. And then select the trigger condition as well.
5. Next, select the recorder's output port and the trigger action
5. Finally, define the trigger duration.

LevelOne NVR Series

Network Video Recorder

-  *The recorder does not control camera's input or output ports in a way to let you pair recorder itself with a camera's input or output port for event receiving or triggering.*
-  *The recorder only acts as a medium for pairing up input/output ports between cameras and the recorder.*
-  *Only connected cameras will be displayed in the list.*
-  *Some cameras only allow one trigger source be configured at a time, e.g.: if the camera has the motion detection function turned on, its digital input will be disabled and vice versa. Under such circumstance, if you set to use camera's digital input port as the event trigger source, you will not be able to select motion detection as the trigger source for this camera under "Event Configurations" >> "Event Trigger" setup page.*

3.3.3 Event Servers

Event servers are to be used with event trigger actions. In case of unusual motion detected by the camera or a disk failure, the recorder can send notification with the acceptable format (image/txt) to a destined event server according to the configuration.

Configuring an FTP server

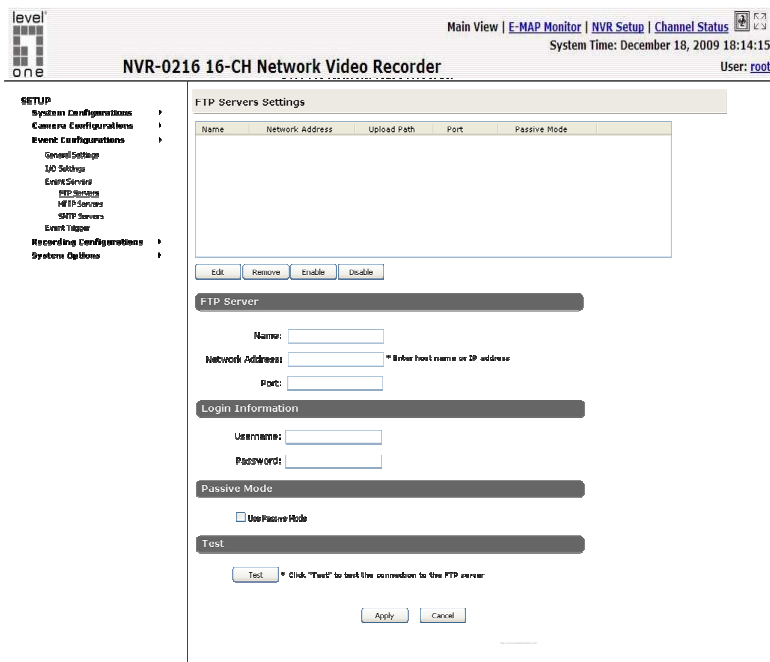

To add an FTP server,

1. Start by giving a name to the server that you are adding to the recorder
2. Enter the hostname or the IP address of the FTP server
3. Enter the communication port of the FTP server (usually port 21)

FTP Server

Name:

Network Address: * Enter host name or IP address

Port:

4. Enter the username and password of the FTP server if it's required
5. Check "Use Passive Mode" if it's required or leave it unchecked to use active mode

Login Information

Username:

Password:

Passive Mode

Use Passive Mode

6. Click "Test" to verify if all information is entered correctly and the connection to the FTP server can be established successfully
7. Click "Apply" for the settings to take effect

Test

* Click "Test" to test the connection to the FTP server

 If you wish to edit/remove/enable/disable an FTP server, click to highlight one from the profile list and choose the corresponding action button

Name	Network Address	Upload Path	Port	Passive Mode
FTP 1	192.168.101.100	event	21	No

Configuring an HTTP server

The screenshot shows the web interface for the LevelOne NVR-0216 16-CH Network Video Recorder. The top navigation bar includes links for 'Main View', 'E-MAP Monitor', 'NVR Setup', and 'Channel Status'. The system time is 'December 18, 2009 18:14:15' and the user is 'root'. The left sidebar contains a 'SETUP' menu with categories: System Configurations, Camera Configurations, Event Configurations, Recording Configurations, and System Options. The 'Event Configurations' category is expanded to show 'HTTP Servers'. The main content area is titled 'HTTP Servers Settings' and features a table with columns for 'Name', 'Network Address', and 'Port'. Below the table are buttons for 'Edit', 'Remove', 'Enable', and 'Disable'. A section titled 'HTTP Server' contains input fields for 'Name', 'Network Address', 'Port', 'Username', and 'Password'. A 'Test' section includes a 'Test' button and a tooltip that reads 'Click "Test" to test the connection to the HTTP server'. At the bottom are 'Apply' and 'Cancel' buttons.

1. Start by giving it a name as well
2. Enter the hostname or the IP address of the HTTP server
3. Enter the port that's used to communicate with the server
4. Enter the username and password if it's required
5. Click "Test" to verify if the information is entered correctly
6. Click "Apply" for the settings to take effect

Configuring an SMTP server

The screenshot shows the web interface for configuring SMTP servers. The header includes the LevelOne logo, navigation links (Main View, E-MAP Monitor, NVR Setup, Channel Status), system time (December 18, 2009 18:14:15), and user information (User: root). The left sidebar lists various configuration categories under 'SETUP'. The main content area is titled 'SMTP Servers Settings' and contains two identical configuration blocks for 'SMTP Server 1' and 'SMTP Server 2'. Each block includes input fields for 'Network Address', 'Port', 'Sender's Name', and 'Sender's E-Mail'. There is a checkbox for 'Enable Authentication' and, if checked, fields for 'Username' and 'Password'. A 'Test' section below each server configuration includes a 'Send test email to:' field and a 'Send' button.

1. Enter the hostname or the IP address of the SMTP server
2. Enter the port of the SMTP server
3. Specify the sender's name in the "Sender's name" field
4. Enter the sender's e-mail address
5. Check "Enable Authentication" and enter the username and password of the SMTP server and it requires authentication
6. Click "Apply" to save the configuration

3.3.3 Event Triggers

We have finished defining how an event will be triggered and which servers will be receiving notifications in the previous two sections, now we can finish up the event configuration by setting:

- . Which channels will have event trigger function enabled
- . What is considered to be an event
- . Where the warnings will be sent to and how they will be sent

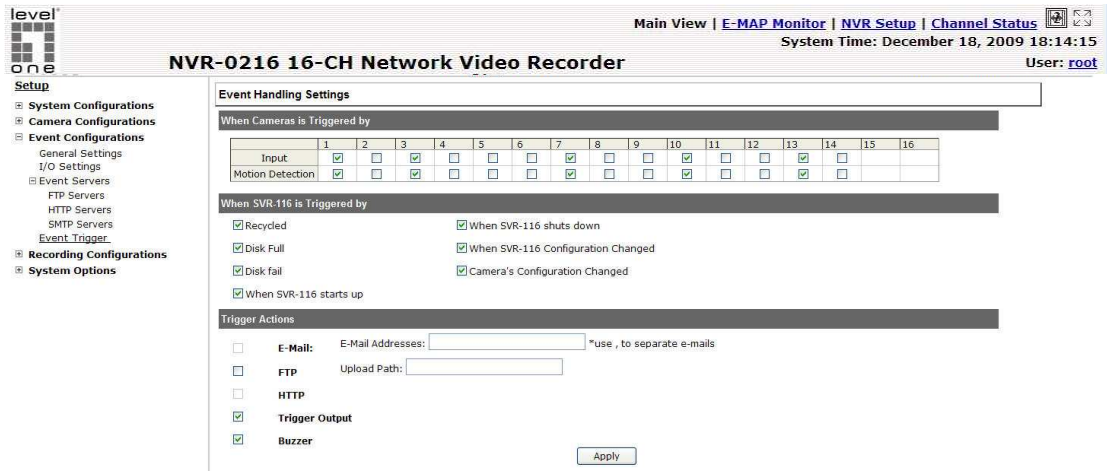

Select Channels to Enable Event Trigger and which type of event should be triggered

- . Use the checkbox to enable event trigger on the desired channels

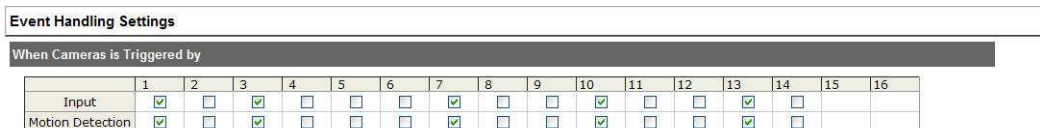

- Define which system events should trigger the recorder to send out notifications

When NVR-0216 is Triggered by

- Recycle
- When NVR-0216 Shuts down
- Disk Full
- When NVR-0216 Configuration Changed
- Disk Fail
- Camera Configuration Changed
- When NVR-0216 Starts up

- Define how the notifications will be sent and where they will be sent to

Trigger Actions

- E-Mail:** E-Mail Addresses: *use "," to separate e-mails
- FTP** Upload Path:
- HTTP**
- Trigger Output**
- Buzzer**

** Event trigger may not work for cameras that are placed outside of your local network or on the Internet until the UPnP Port Forwarding is enabled in both the NVR and the router.*

3.4 Recording Configurations

The “recording configurations” gives users the overall control of how and when a recording is performed and the quality of different types of recordings performed on each channels. It can help the recorder to operate with sufficient system resource by performing recording only when it's necessary with adjustable recording frame rate.

3.4.1 General Settings

You can define the following in “General Settings”:

- . Pre-Alarm/Post-Alarm recording length
- . Recording frame rate
- . Enable/disable different recording types on different cameras

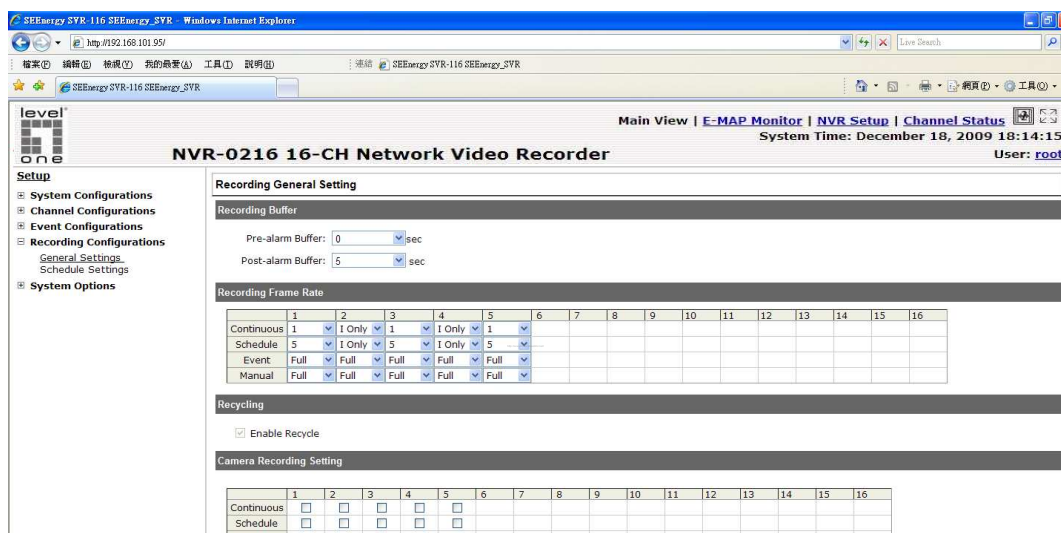

The “recording configurations” gives users the overall control of how and when a recording is performed and the quality of different types of recordings performed on each channels. It can help the recorder to operate with sufficient system resource by performing recording only when it’s necessary with adjustable recording frame rate.

Recording Buffer

Pre-alarm Buffer: sec

Post-alarm Buffer: sec

Recording frame rate allows you to set different frame rate for different types of recording instead of recording at one frame rate only. Use the drop-down menu and select one of the pre-defined frame rates for a particular recording type

Recording Frame Rate																
	1	2	3	4	5	6	7	8	9	10	11	12	13	14	15	16
Continuous	1	I Only	1	I Only	1											
Schedule	5	I Only	5	I Only	5											
Event	Full	Full	Full	Full	Full											
Manual	Full	Full	Full	Full	Full											

The section at the bottom allows you to turn on or off a particular recording type on any channels.

Camera Recording Setting

	1	2	3	4	5	6	7	8	9	10	11	12	13	14	15	16
Continuous	<input type="checkbox"/>	<input type="checkbox"/>	<input type="checkbox"/>	<input type="checkbox"/>	<input type="checkbox"/>											
Schedule	<input type="checkbox"/>	<input type="checkbox"/>	<input type="checkbox"/>	<input type="checkbox"/>	<input type="checkbox"/>											
Event	<input type="checkbox"/>	<input type="checkbox"/>	<input type="checkbox"/>	<input type="checkbox"/>	<input type="checkbox"/>											

3.4.2 Schedule Recording

Here you can define the time range of the schedule recording for all channels.

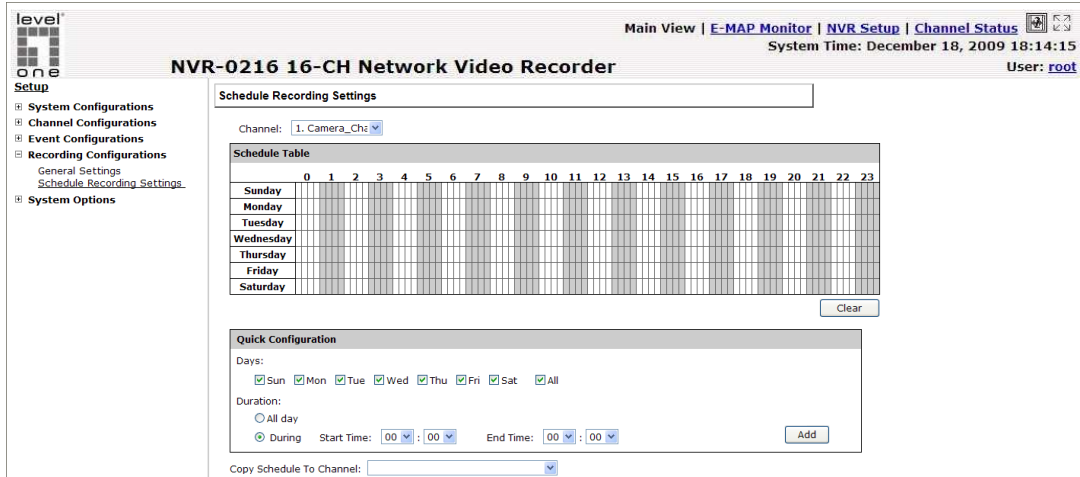

To configure a schedule recording:

1. Use the “Camera” drop-down menu and select a camera first

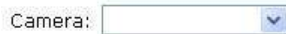

2. You can use the schedule table to set the time range. Click the cell boxes then move the cursor horizontally lets you set what hours to perform recording during a day. Click and move vertically lets you set what days to perform recording at a specific time.

Schedule Table		0	1	2	3	4	5	6	7	8	9	10	11	12	13	14	15	16	17	18	19	20	21	22	23
Sunday																									
Monday																									
Tuesday																									
Wednesday																									
Thursday																									
Friday																									
Saturday																									

* Each cell box represents 15 minutes of time. Click one or more boxes to omit consecutive recording

3. You can also use the “Quick Configuration” to define recording time range instead of clicking cell boxes one by one on the time table. Simply check what days you would like to perform recording and specify the recording duration by either choosing “All Day” or enter a start and end time for specific recording duration.

Quick Configuration

Days

Mon. Tue. Wed. Thur. Fri. Sat. Sun.

Duration

All day

During Start Time: End Time:

4. Select the “Copy to” option if you would like to set the same recording schedule to another camera.

During Start Time: : End Time: :

Copy Schedule To Channel:

3.5 System Options

System Options gives users a glance of the overall system status and allows users to perform maintenance tasks such as upgrading firmware, restore/backup device settings or reboot deviceetc.

3.5.1 Device Information

The “Device Information” provides the general information of the device such as firmware version and system time. It also provides information of the current network settings and status.

Setup

- System Configuration
- Channel Configuration
- Event Configuration
- Recording Configuration
- System Options
- Device Information
- System Logs
- Maintenance
- DO Status
- Disk Status
- UPS Configuration

General Information

Device Name: tst
Model Name: NVR-0216
Firmware Version: 1.0
Device Time: Up 0 days 16:56:55, since May 05 2009 18:56:23

Network Information

Network Type: DHCP
Device IP: 192.168.102.2
HTTP Port: 80
Streaming Port: 9877
MAC Address: 00:28:68:78:31:03
DHCP Server: Disabled
UPnP Port Forwarding: Disabled

Current DHCP Clients

3.5.2 Logs and Reports

“Logs and Reports” keeps a record of what’s been happening to the device and provides basic information for troubleshooting

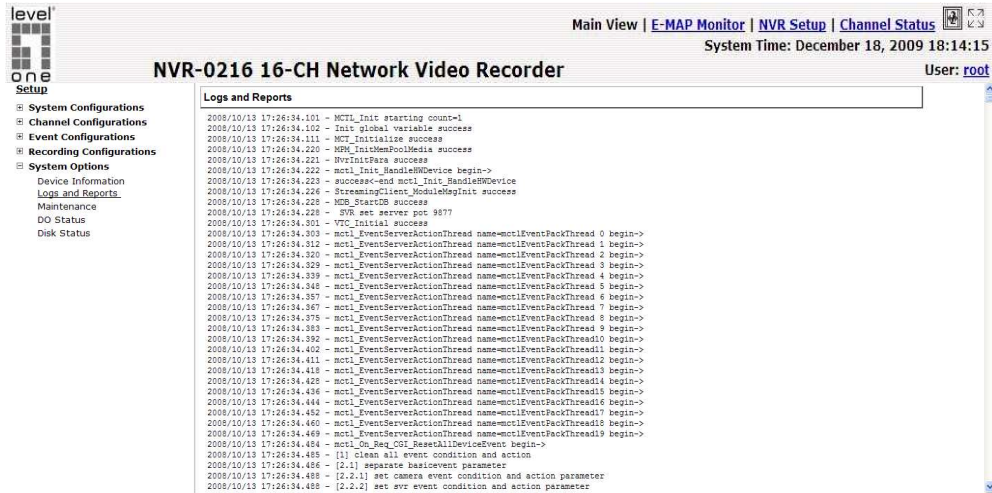

3.5.3 Maintenance

“Maintenance” provides functions for users to:

- Reboot the NVR when necessary
- Reboot cameras directly from the NVR
- Perform Firmware Upgrade
- Backup the NVR’s settings to a local hard drive
- Restore the NVR’s settings from a previously saved configuration file
- Reset the NVR’s settings to their factory default values

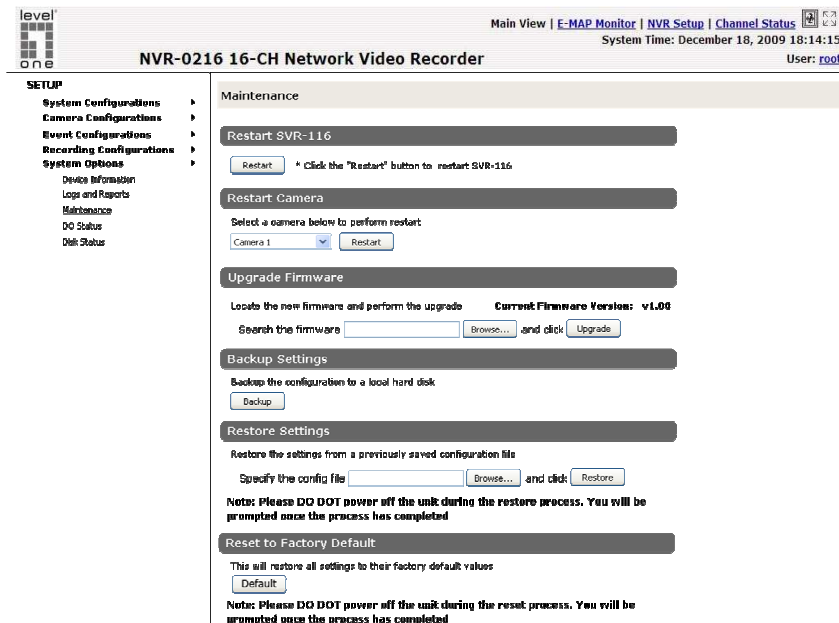

LevelOne NVR Series

Network Video Recorder

Reboot the NVR

Reboot NVR-0216 after you upload a new firmware. You would need to manually reboot the system for the new firmware to take effect. Such process would prevent a recording from getting interrupted because the system would not automatically reboot itself after the new firmware is loaded onto the recorder.

Simply click “Restart” to begin the reboot process and confirm the action:

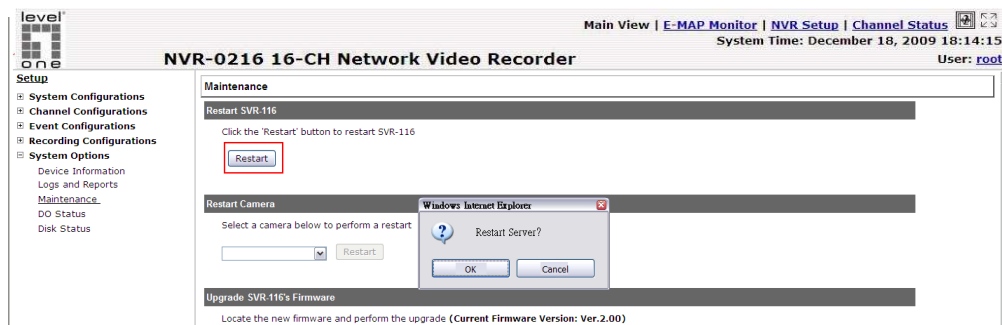

The restart process should be displayed and you should be prompted back to the “Maintenance” page after it is complete:

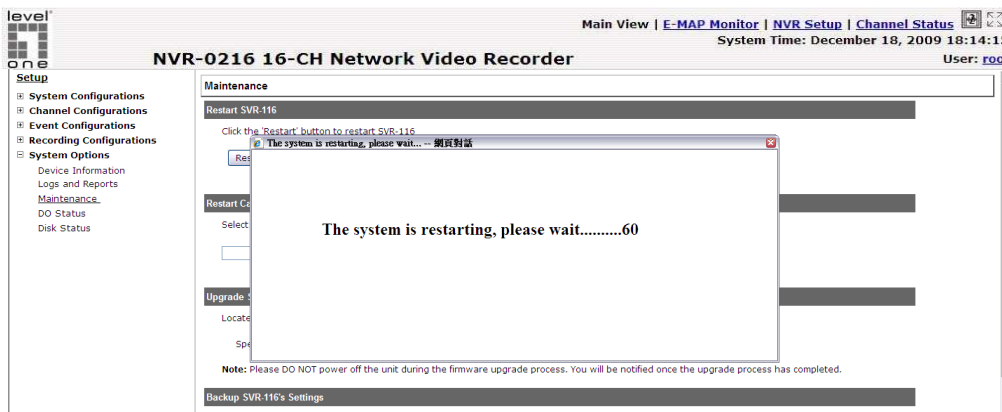

LevelOne NVR Series

Network Video Recorder

Reset the NVR to Factory Default

To reset the recorder back to its factory default, click “Default” button and begin the process:

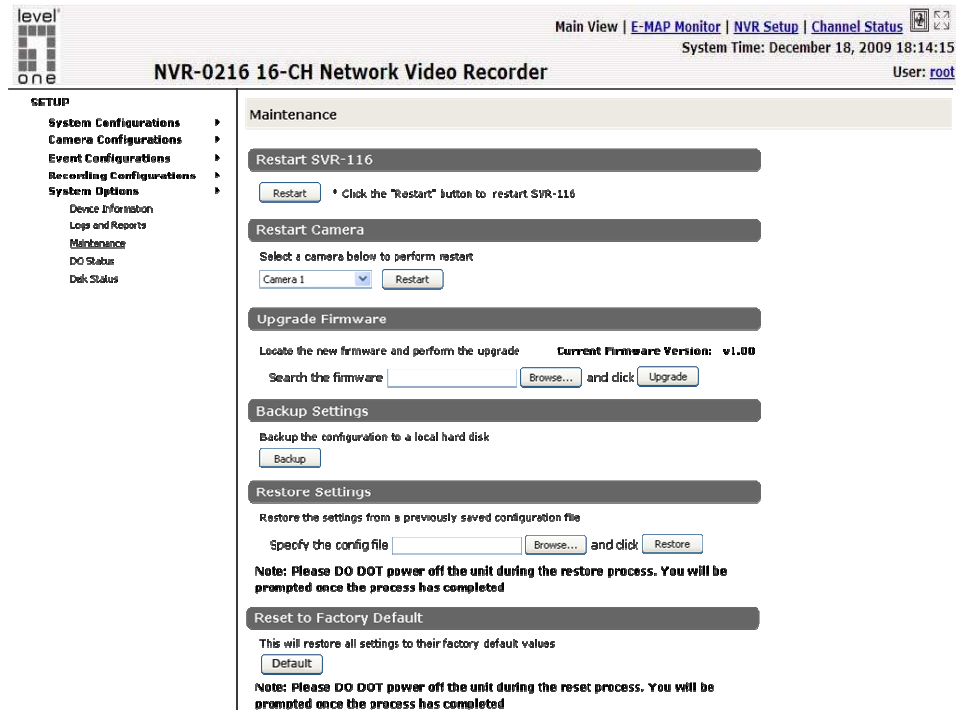

The process should be displayed and you should be prompted back to the “Maintenance” page after it is complete:



Hardware reset procedure:

- 1) Find the reset button at the front panel of the NVR unit
- 2) Use a pin to press the reset button for 45 seconds. You would see power LED start flashing as you press it. When you press for 45 seconds, all LED will become solid Red and release the pin.
- 3) Wait for 1 minute for the unit to reboot. When reboot successfully, the LEDs of power, status, network and HD should return to green.

3.5.4 DO Status

This is where you can get the current status of the NVR-0216 digital output ports. You can also change their status from this page.

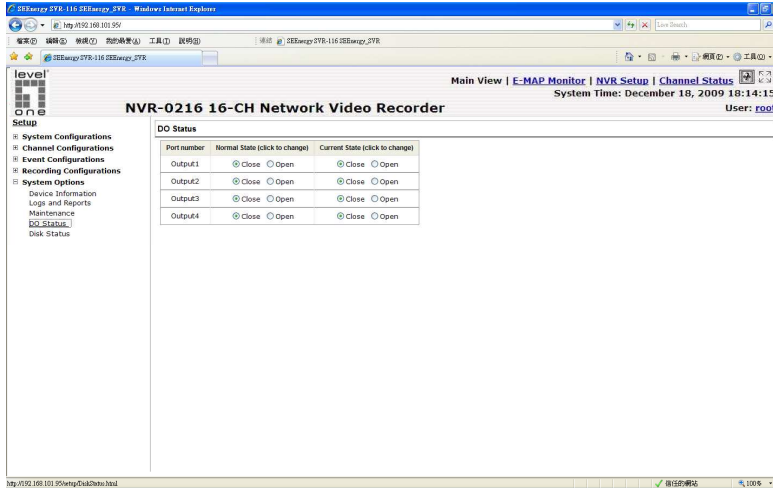

3.5.5 Disk Status

“Disk Status” gives you more detailed information of the hard drive that is currently installed in the NVR.

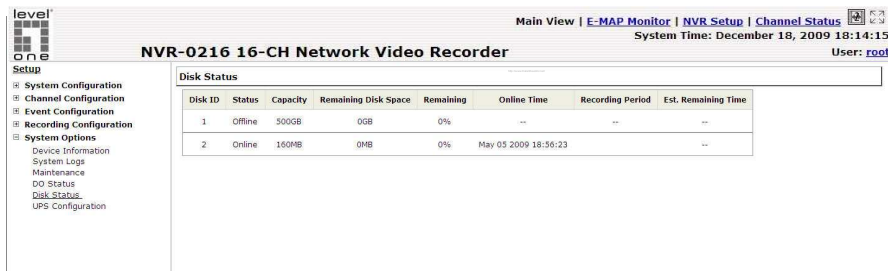

3.5.6 Ups Configuration

Connect the UPS to the NVR's DI/DO port for sending and receiving signals between the UPS and the NVR. Refer to the diagram below to connect the UPS with its RS-232 interface to the NVR's DI/DO port.

The NVR can receive signal from the UPS when there is a power failure and shut down itself automatically within a period of time.

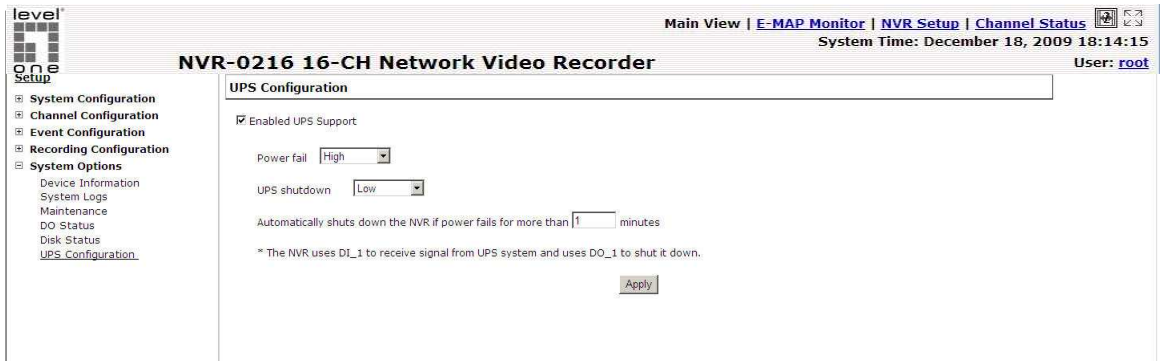

Connect UPS with its RS-232 interface to the NVR's 10 port:

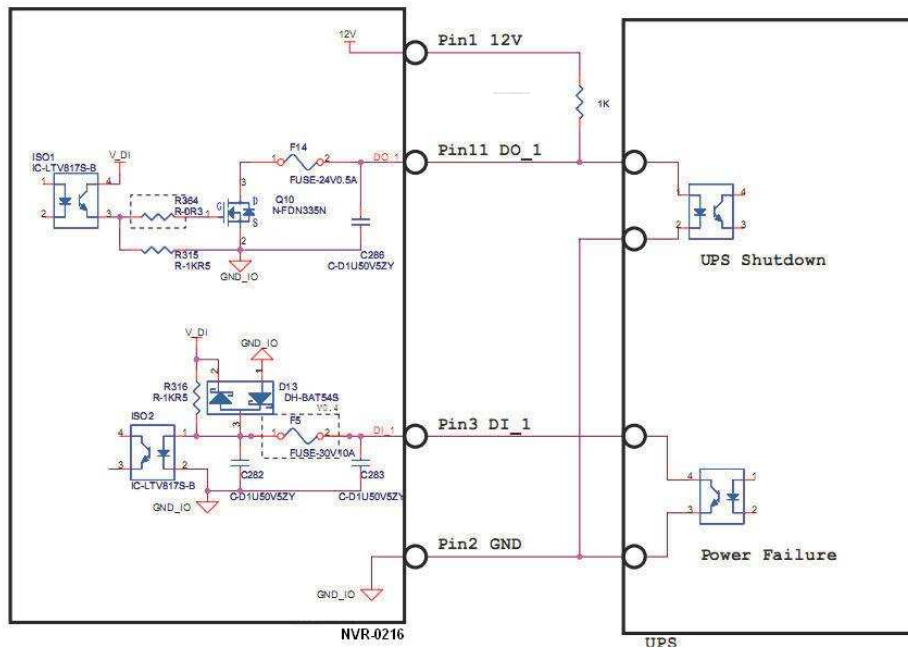

* The NVR uses DI_1 to receive signal from UPS system and uses DO_1 to shut it down.

LevelOne NVR Series

Network Video Recorder

NVR recording time table for reference (it maybe different test result with each environment)

Compression			MPEG4								MJPEG			
			long		standard		fine		super fine		320 x 240	448 x 336	640 x 480	1280 x 1024
Model	HDD	Camera (pcs)	bit rate (K)								fps			
			100K	200K	300K	400K	600K	800K	1000K	2000K	1	1	1	1
NVR2016	250GB	1	220 days	110 days	73 days	55 days	36 days	27 days	22 days	11 days	220 days	110 days	55 days	12 days
		4	55 days	27 days	18 days	13 days	9 days	6 days	5 days	2 days	55 days	27 days	13 days	3 days
		8	27 days	13 days	9 days	6 days	4 days	3 days	2 days	1 days	27 days	13 days	6 days	1 days
		12	18 days	9 days	6 days	4 days	3 days	2 days	1 days	0 days	18 days	9 days	4 days	1 days
		16	13 days	6 days	4 days	3 days	2 days	1 days	1 days	0 days	13 days	6 days	3 days	0 days
	500GB	1	441 days	220 days	147 days	110 days	73 days	55 days	44 days	22 days	441 days	220 days	110 days	25 days
		4	110 days	55 days	36 days	27 days	18 days	13 days	11 days	5 days	110 days	55 days	27 days	6 days
		8	55 days	27 days	18 days	13 days	9 days	6 days	5 days	2 days	55 days	27 days	13 days	3 days
		12	36 days	18 days	12 days	9 days	6 days	4 days	3 days	1 days	36 days	18 days	9 days	2 days
		16	27 days	13 days	9 days	6 days	4 days	3 days	2 days	1 days	27 days	13 days	6 days	1 days
	1000GB	1	882 days	441 days	294 days	220 days	147 days	110 days	88 days	44 days	882 days	441 days	220 days	51 days
		4	220 days	110 days	73 days	55 days	36 days	27 days	22 days	11 days	220 days	110 days	55 days	12 days
		8	110 days	55 days	36 days	27 days	18 days	13 days	11 days	5 days	110 days	55 days	27 days	6 days
		12	73 days	36 days	24 days	18 days	12 days	9 days	7 days	3 days	73 days	36 days	18 days	4 days
		16	55 days	27 days	18 days	13 days	9 days	6 days	5 days	2 days	55 days	27 days	13 days	3 days
	2000GB	1	1765 days	882 days	588 days	441 days	294 days	220 days	176 days	88 days	1765 days	882 days	441 days	103 days
		4	441 days	220 days	147 days	110 days	73 days	55 days	44 days	22 days	441 days	220 days	110 days	25 days
		8	220 days	110 days	73 days	55 days	36 days	27 days	22 days	11 days	220 days	110 days	55 days	12 days
		12	147 days	73 days	49 days	36 days	24 days	18 days	14 days	7 days	147 days	73 days	36 days	8 days
		16	110 days	55 days	36 days	27 days	18 days	13 days	11 days	5 days	110 days	55 days	27 days	6 days
4000GB	1	7061 days	3530 days	2353 days	1765 days	1176 days	882 days	706 days	353 days	7061 days	3530 days	1765 days	413 days	
	4	1765 days	882 days	588 days	441 days	294 days	220 days	176 days	88 days	1765 days	882 days	441 days	103 days	
	8	882 days	441 days	294 days	220 days	147 days	110 days	88 days	44 days	882 days	441 days	220 days	51 days	
	12	588 days	294 days	196 days	147 days	98 days	73 days	58 days	29 days	588 days	294 days	147 days	34 days	
	16	441 days	220 days	147 days	110 days	73 days	55 days	44 days	22 days	441 days	220 days	110 days	25 days	