

NICHIA CORPORATION

SPECIFICATIONS FOR UV LED

NVSU333A(T)

- Pb-free Reflow Soldering Application
- Built-in ESD Protection Device
- RoHS Compliant

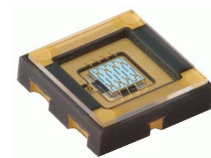

SPECIFICATIONS

(1) Absolute Maximum Ratings

Item	Symbol	Absolute Maximum Rating	Unit
Forward Current	I_F	4500	mA
Pulse Forward Current	I_{FP}	6000	mA
Allowable Reverse Current	I_R	85	mA
Power Dissipation	P_D	18.9	W
Operating Temperature	T_{opr}	-10~85	°C
Storage Temperature	T_{stg}	-40~100	°C
Junction Temperature	T_J	100	°C

* Absolute Maximum Ratings at $T_S=25^\circ\text{C}$.

* I_{FP} conditions with pulse width $\leq 10\text{ms}$ and duty cycle $\leq 10\%$.

(2) Initial Electrical/Optical Characteristics

Item		Symbol	Condition	Typ	Max	Unit
U365	Forward Voltage	V_F	$I_F=3500\text{mA}$	3.85	-	V
	Radiant Flux	Φ_e	$I_F=3500\text{mA}$	3640	-	mW
	Peak Wavelength	λ_p	$I_F=3500\text{mA}$	365	-	nm
	Spectrum Half Width	$\Delta \lambda$	$I_F=3500\text{mA}$	9.0	-	nm
U385	Forward Voltage	V_F	$I_F=3500\text{mA}$	3.75	-	V
	Radiant Flux	Φ_e	$I_F=3500\text{mA}$	4640	-	mW
	Peak Wavelength	λ_p	$I_F=3500\text{mA}$	385	-	nm
	Spectrum Half Width	$\Delta \lambda$	$I_F=3500\text{mA}$	11	-	nm
U405	Forward Voltage	V_F	$I_F=3500\text{mA}$	3.55	-	V
	Radiant Flux	Φ_e	$I_F=3500\text{mA}$	4640	-	mW
	Peak Wavelength	λ_p	$I_F=3500\text{mA}$	405	-	nm
	Spectrum Half Width	$\Delta \lambda$	$I_F=3500\text{mA}$	12	-	nm
Thermal Resistance		$R_{\theta JS}$	-	1.68	2.08	°C/W

* Characteristics at $T_S=25^\circ\text{C}$.

* Radiant Flux value as per CIE 127:2007 standard.

* $R_{\theta JS}$ is the thermal resistance from the junction to the T_S measurement point.

* It is recommended to operate the LEDs at a current greater than 10% of the sorting current to stabilize the LED characteristics.

RANKS

Item	Rank	Min	Max	Unit
Forward Voltage	H1	4.0	4.2	V
	M	3.6	4.0	
	L	3.2	3.6	
	K2	3.0	3.2	
Radiant Flux	P17d22	5790	6310	mW
	P17d21	5310	5790	
	P16d22	4870	5310	
	P16d21	4470	4870	
	P15d22	4100	4470	
	P15d21	3760	4100	
	P14d22	3450	3760	
	P14d21	3160	3450	
Peak Wavelength	U405	400	410	nm
	U385	380	390	
	U365	360	370	

* Ranking at T_s=25°C.

* Forward Voltage Tolerance: ±0.05V

* Radiant Flux Tolerance: ±6%

* Peak Wavelength Tolerance: ±3nm

* LEDs from the above ranks will be shipped. The rank combination ratio per shipment will be decided by Nichia.

Forward Voltage Ranks by Peak Wavelength

Ranking by Peak Wavelength \ Ranking by Forward Voltage	K2	L	M	H1
U365,U385				
U405				

Radiant Flux Ranks by Peak Wavelength

Ranking by Peak Wavelength \ Ranking by Radiant Flux	P14d21	P14d22	P15d21	P15d22	P16d21	P16d22	P17d21	P17d22
U365								
U385,U405								

OUTLINE DIMENSIONS

* 本製品はRoHS指令に適合しております。
This product complies with RoHS Directive.

NVSU333A
管理番号 No. STS-DA7-5905B

* 括弧で囲まれた寸法は参考値です。
The dimension(s) in parentheses are for reference purposes.

(単位 Unit: mm, 公差 Tolerance: ±0.2)

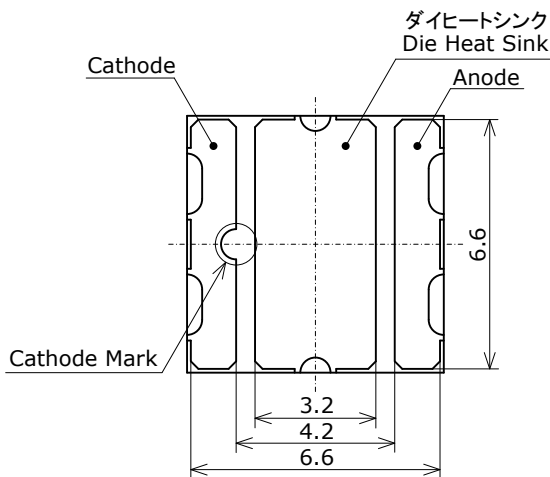
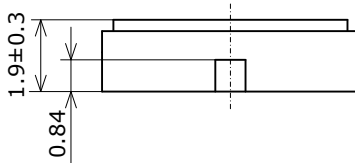
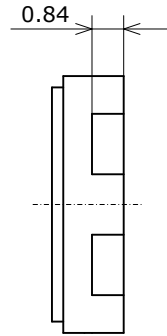
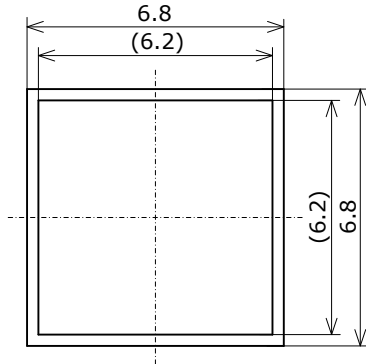

項目 Item	内容 Description
パッケージ材質 Package Materials	セラミックス Ceramics
ガラス窓材質 Glass Materials	硬質ガラス Hard Glass
接着剤材質 Adhesive Materials	シリコーン Silicone Adhesive
電極材質 Electrodes Materials	金メッキ Au-plated
ダイヒートシンク材質 Die Heat Sink Materials	金メッキ Au-plated
質量 Weight	0.26g(TYP)

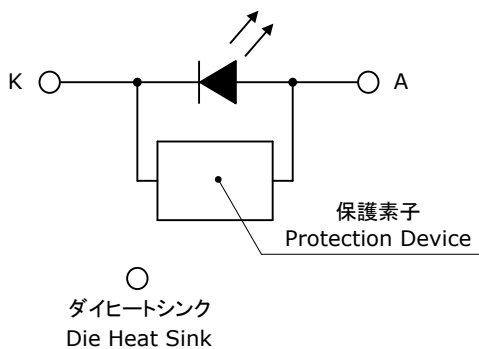

SOLDERING

- Recommended Reflow Soldering Condition(Lead-free Solder)

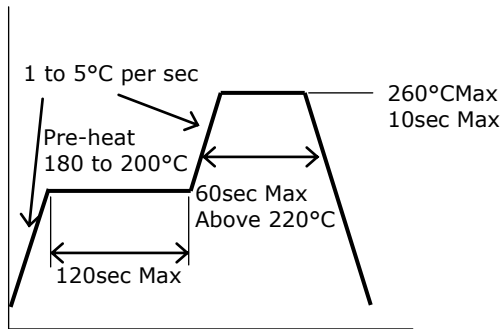

- Recommended Soldering Pad Pattern

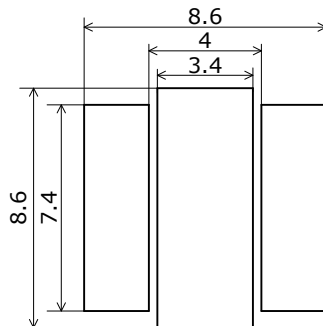

(単位 Unit: mm)

- * This LED is designed to be reflow soldered to a PCB. If dip soldered or hand soldered, Nichia will not guarantee its reliability.
- * Reflow soldering must not be performed more than twice.
- * When the LEDs are cooled from the peak reflow temperature, ensure that the cooling is performed very gradually to avoid excessive stress on the LED (e.g. causing cracks in the solder joints). Ensure that sufficient preliminary verification is performed to ensure that there are no issues with the chosen reflow soldering conditions/process.
- * During reflow soldering, the heat and atmosphere in the reflow oven may cause the optical characteristics to degrade. In particular, reflow soldering performed with an air atmosphere may have a greater negative effect on the optical characteristics than if a nitrogen atmosphere is used; Nichia recommends using a nitrogen reflow atmosphere.
- * Repairing should not be done after the LEDs have been soldered. It should be confirmed beforehand whether the characteristics of the LEDs will or will not be damaged by repairing.
- * The Die Heat Sink should be soldered to customer PCB. If it is difficult or impossible, use high heat-dissipating adhesive.
- * When soldering, do not apply stress to the LED while the LED is hot.
- * When using a pick and place machine, choose an appropriate nozzle for this product.
- * The soldering pad pattern above is a general recommendation for LEDs to be mounted without issues; if a high degree of precision is required for the chosen application (i.e. high-density mounting), ensure that the soldering pad pattern is optimized.
- * When flux is used, it should be a halogen free flux. Ensure that the manufacturing process is not designed in a manner where the flux will come in contact with the LEDs.
- * Ensure that there are no issues with the type and amount of solder that is being used.

PACKAGING - BULK

シリカゲルとともにICパックをアルミ防湿袋に入れ、熱シールにより封をします。
Anti-static IC packs are shipped with desiccants in heat-sealed moisture-proof bags.

Nxxxxxxx
管理番号 No. STS-DA7-11842A

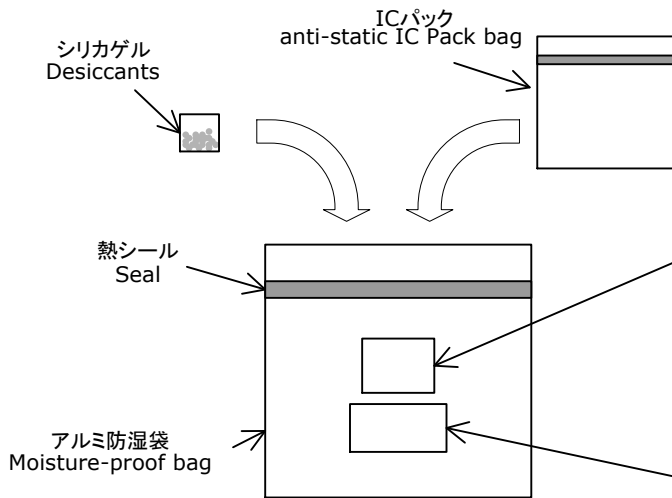

ラベル Label

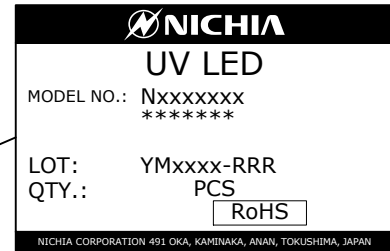

警告ラベル Warning and Explanatory Labels

UV LED

- ・「UV LEDは紫外領域の光(UV光)を発生します。」
- ・「UV光は人間の目には見えませんが、光が見えていなくてもUV光により目を傷める可能性があります。」
- ・「UV光を直接目にあてないでください。必ず適切な防具を着用してください。」
- ・「UV LEDを組み込んだ製品には、適切な警告表示をしてください。」

- ・ UV LEDs emit light in the ultraviolet region (UV light).
- ・ UV light is invisible and may be harmful to the human eye.
- ・ Do not expose the eyes directly to the UV light. Wear appropriate protective gear when handling.
- ・ Use appropriate warning signs/labels on devices using the UV LEDs.

アルミ防湿袋を並べて入れ、間隔にはクッション材を詰めます。
Moisture-proof bags are packed in cardboard boxes with shock absorbing materials to fill empty spaces.

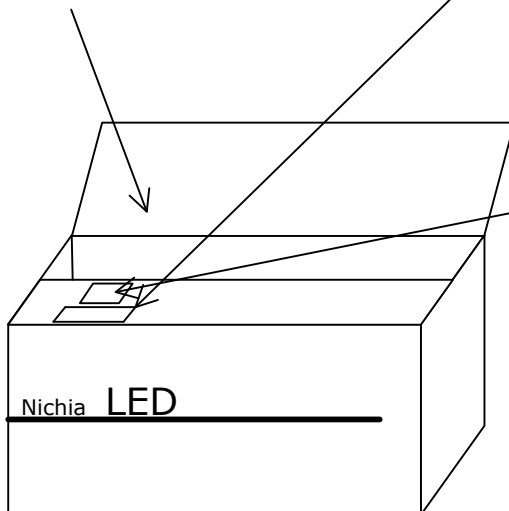

ラベル Label

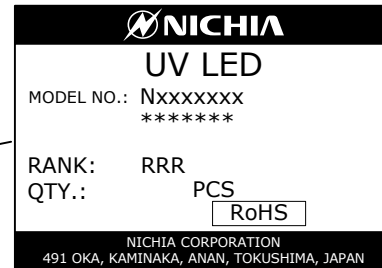

- * 客先型名を*****で示します。
客先型名が設定されていない場合は空白です。
***** is the customer part number.
If not provided, it will not be indicated on the label.
- * ロット表記方法についてはロット番号の項を参照して下さい。
For details, see "LOT NUMBERING CODE" in this document.

- * 本製品はICパックに入れたのち、輸送の衝撃から保護するためダンボールで梱包します。
Products shipped in anti-static IC packs are packed in a moisture-proof bag.
They are shipped in cardboard boxes to protect them from external forces during transportation.
- * 取り扱いに際して、落下させたり、強い衝撃を与えたりしますと、製品を損傷させる原因になりますので注意して下さい。
Do not drop or expose the box to external forces as it may damage the products.
- * ダンボールには防水加工がされておりませんので、梱包箱が水に濡れないよう注意して下さい。
Do not expose to water. The box is not water-resistant.
- * 輸送、運搬に際して弊社よりの梱包状態あるいは同等の梱包を行って下さい。
Using the original package material or equivalent in transit is recommended.

TAPE AND REEL DIMENSIONS

テーピング部 Tape

Nxxx333x
管理番号 No. STS-DA7-6280

(単位 Unit: mm)

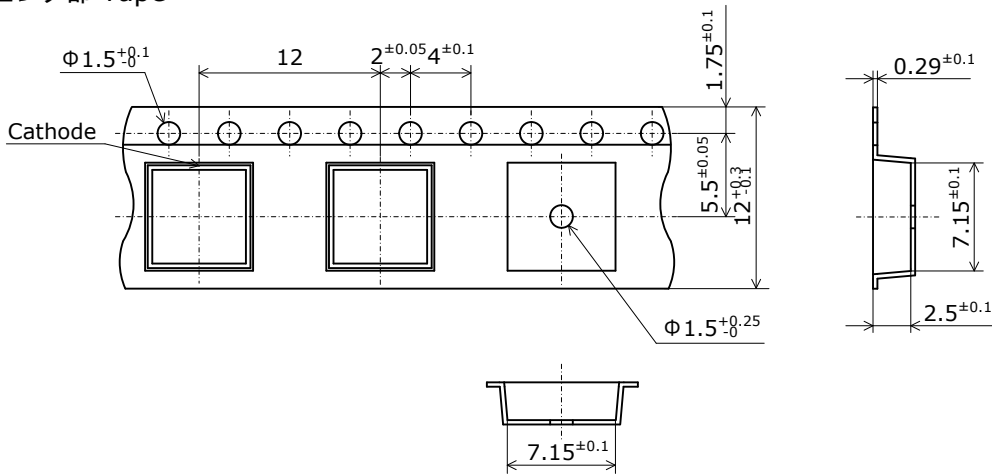

トレーラ部/リーダ部 Trailer and Leader

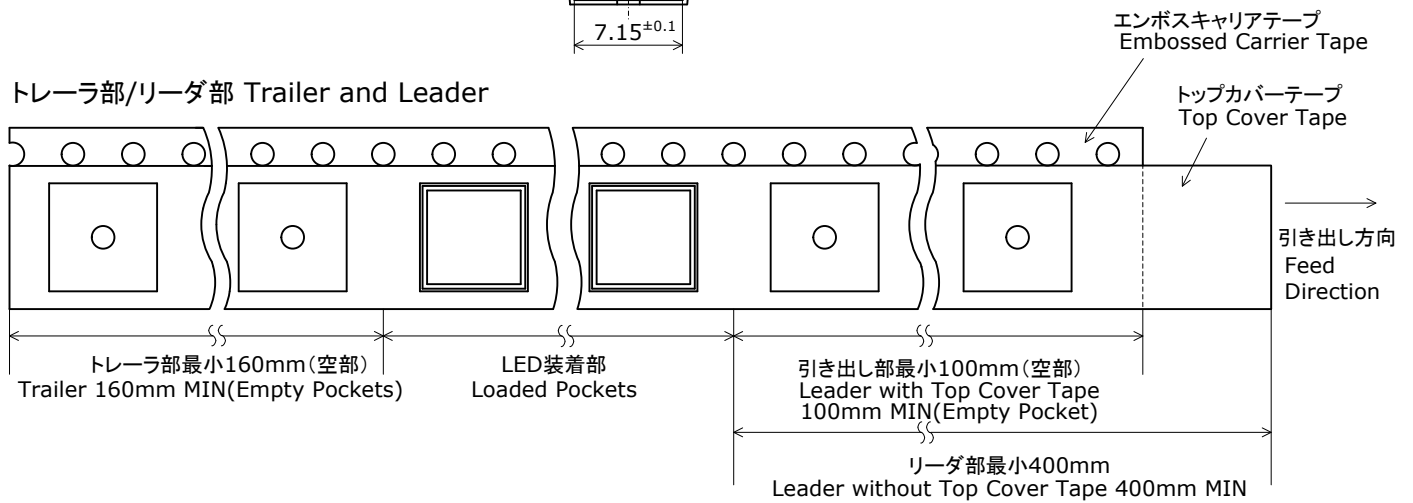

リール部 Reel

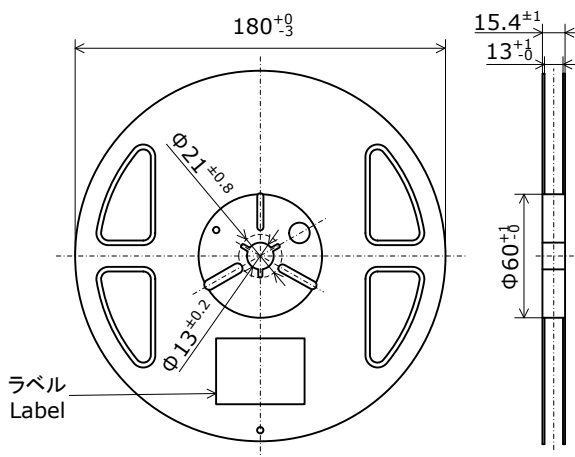

- * 数量は1リールにつき 500個入りです。
Reel Size: 500pcs
- * JIS C 0806電子部品テーピングに準拠しています。
The tape packing method complies with JIS C 0806
(Packaging of Electronic Components on Continuous Tapes).
- * 実装作業の中断などでエンボスキャリアテープをリールに巻き取る場合、エンボスキャリアテープを強く(10N以上)締めないで下さい。LEDがカバーテープに貼り付く可能性があります。
When the tape is rewound due to work interruptions, no more than 10N should be applied to the embossed carrier tape.
The LEDs may stick to the top cover tape.

PACKAGING - TAPE & REEL

シリカゲルとともにリールをアルミ防湿袋に入れ、熱シールにより封をします。
Reels are shipped with desiccants in heat-sealed moisture-proof bags.

Nxxxxxxx
管理番号 No. STS-DA7-11776A

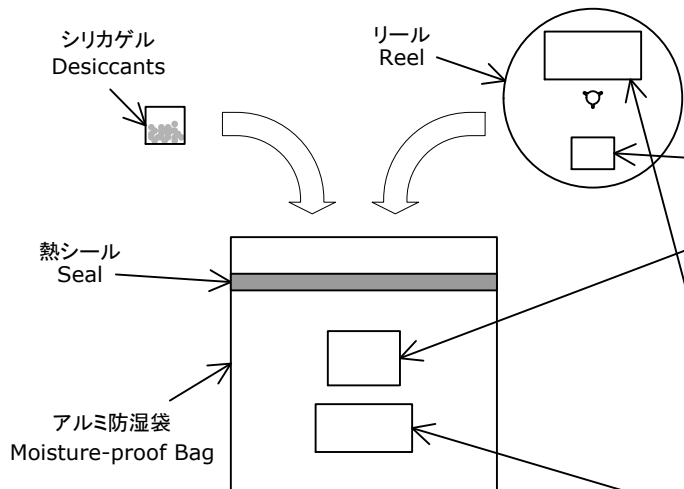

ラベル Label

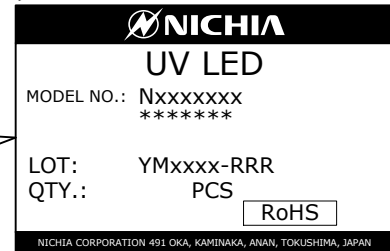

警告ラベル Warning and Explanatory Labels

UV LED

- ・「UV LEDは紫外領域の光(UV光)を発生します。」
- ・「UV光は人間の目には見えませんが、光が見えていなくてもUV光により目を傷める可能性があります。」
- ・「UV光を直接目にあてないでください。必ず適切な防具を着用してください。」
- ・「UV LEDを組み込んだ製品には、適切な警告表示をしてください。」

- ・ UV LEDs emit light in the ultraviolet region (UV light).
- ・ UV light is invisible and may be harmful to the human eye.
- ・ Do not expose the eyes directly to the UV light. Wear appropriate protective gear when handling.
- ・ Use appropriate warning signs/labels on devices using the UV LEDs.

アルミ防湿袋を並べて入れ、ダンボールで仕切ります。
Moisture-proof bags are packed in cardboard boxes with corrugated partitions.

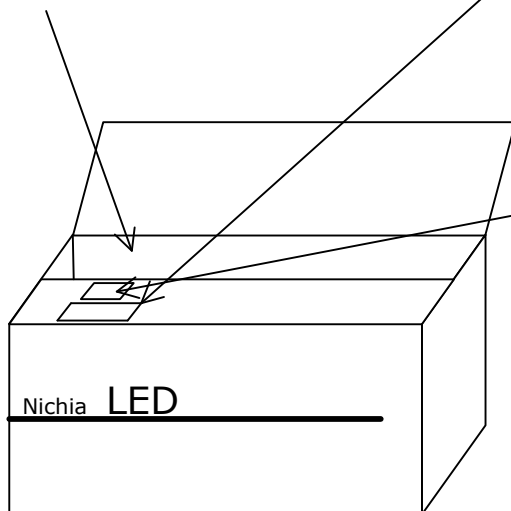

ラベル Label

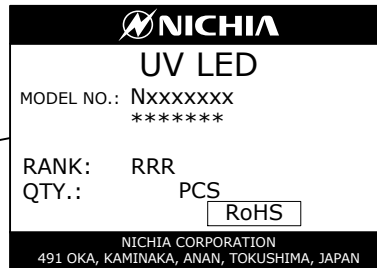

- * 客先型名を*****で示します。客先型名が設定されていない場合は空白です。***** is the customer part number. If not provided, it will not be indicated on the label.
- * ロット表記方法についてはロット番号の項を参照して下さい。For details, see "LOT NUMBERING CODE" in this document.

- * 本製品はテーピングしたのち、輸送の衝撃から保護するためダンボールで梱包します。Products shipped on tape and reel are packed in a moisture-proof bag. They are shipped in cardboard boxes to protect them from external forces during transportation.
- * 取り扱いに際して、落下させたり、強い衝撃を与えたりしますと、製品を損傷させる原因になりますので注意して下さい。Do not drop or expose the box to external forces as it may damage the products.
- * ダンボールには防水加工がされておきませんので、梱包箱が水に濡れないよう注意して下さい。Do not expose to water. The box is not water-resistant.
- * 輸送、運搬に際して弊社よりの梱包状態あるいは同等の梱包を行って下さい。Using the original package material or equivalent in transit is recommended.

LOT NUMBERING CODE

Lot Number is presented by using the following alphanumeric code.

YMxxxx - RRR

Y - Year

Year	Y
2018	I
2019	J
2020	K
2021	L
2022	M
2023	N

M - Month

Month	M	Month	M
1	1	7	7
2	2	8	8
3	3	9	9
4	4	10	A
5	5	11	B
6	6	12	C

xxxx-Nichia's Product Number

RRR-Ranking by Wavelength, Ranking by Radiant Flux, Ranking by Forward Voltage

DERATING CHARACTERISTICS

NVSU333A
管理番号 No. STS-DA7-5906A

周囲温度-許容順電流特性
Ambient Temperature vs
Allowable Forward Current

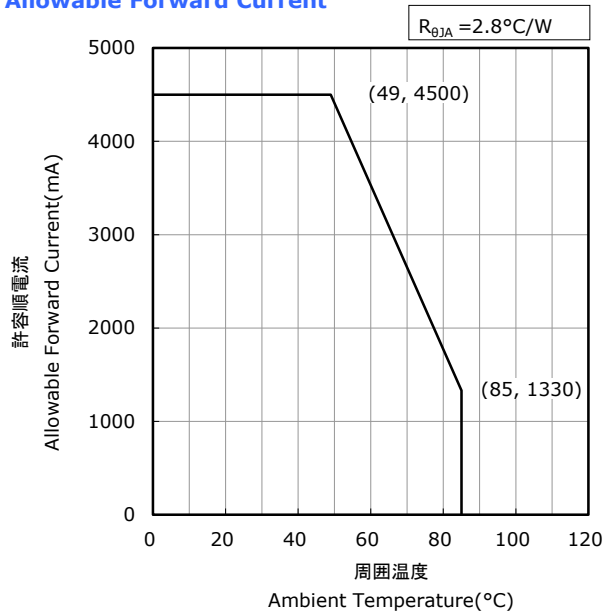

はんだ接合部温度(ダイヒートシンク部)-許容順電流特性
Solder Temperature(Die Heat Sink) vs
Allowable Forward Current

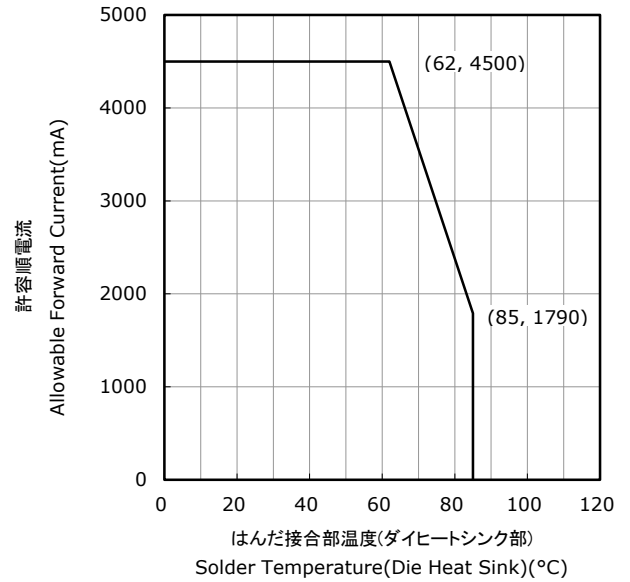

デューティー比-許容順電流特性
Duty Ratio vs
Allowable Forward Current

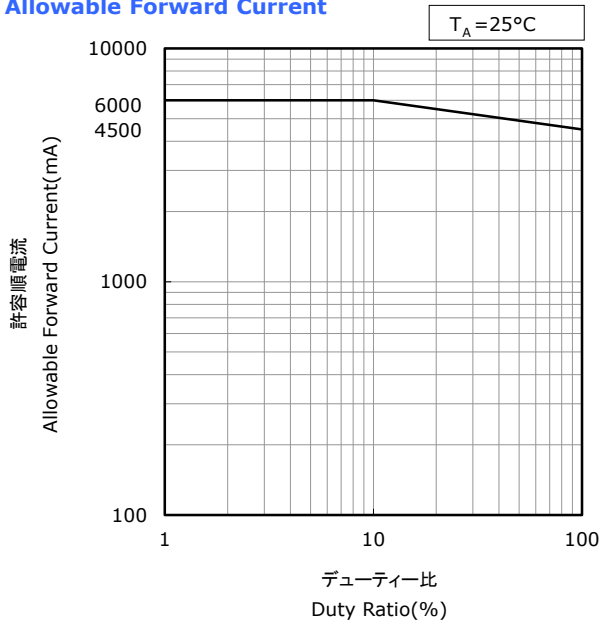

OPTICAL CHARACTERISTICS

* 本特性は参考です。
All characteristics shown are for reference only and are not guaranteed.

NVSU333A
管理番号 No. STS-DA7-6232A

発光スペクトル Spectrum

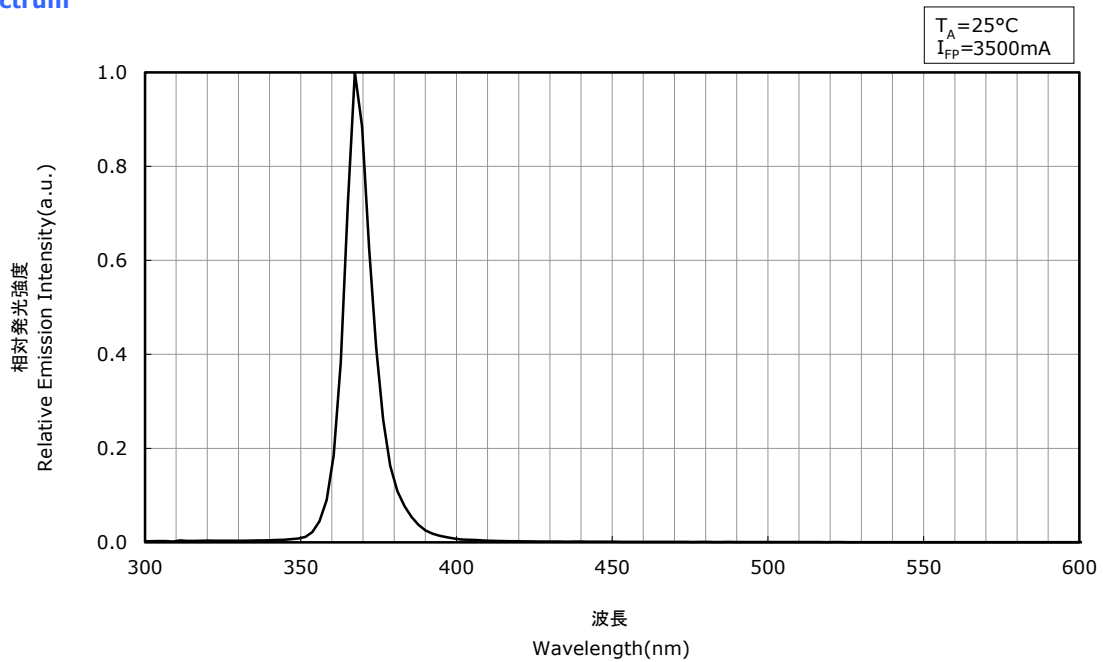

指向特性 Directivity

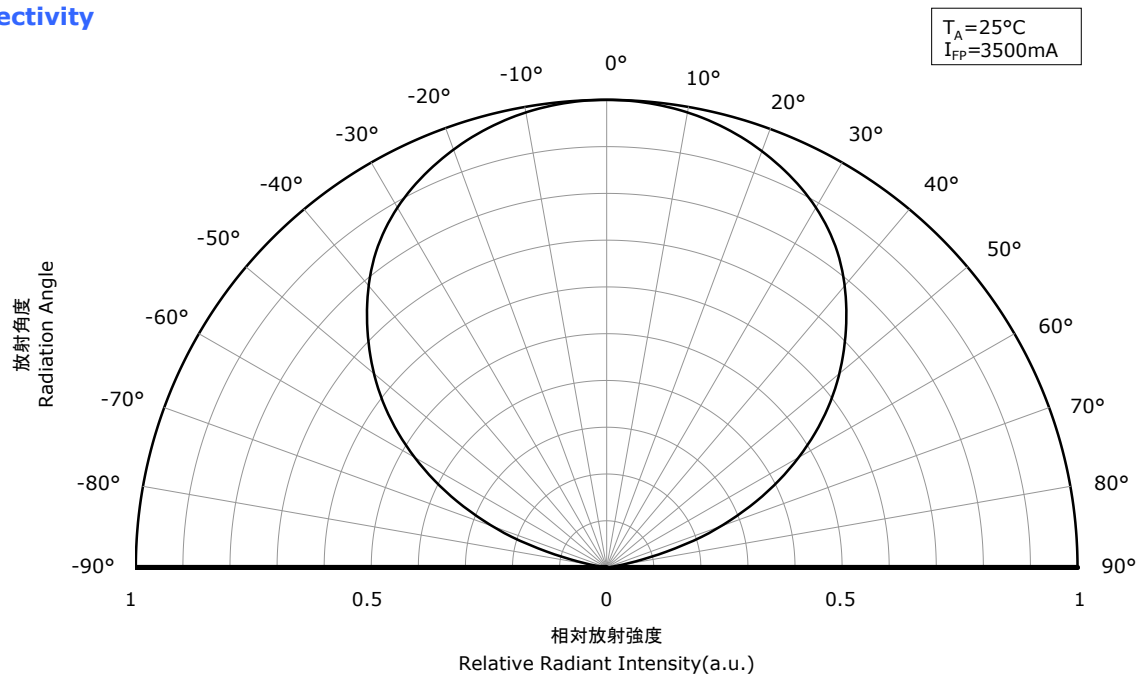

* 本特性はピーク波長ランクU365xに対応しています。
The graphs above show the characteristics for U365x LEDs of this product.

OPTICAL CHARACTERISTICS

* 本特性は参考です。
All characteristics shown are for reference only and are not guaranteed.

NVSU333A
管理番号 No. STS-DA7-6233A

発光スペクトル
Spectrum

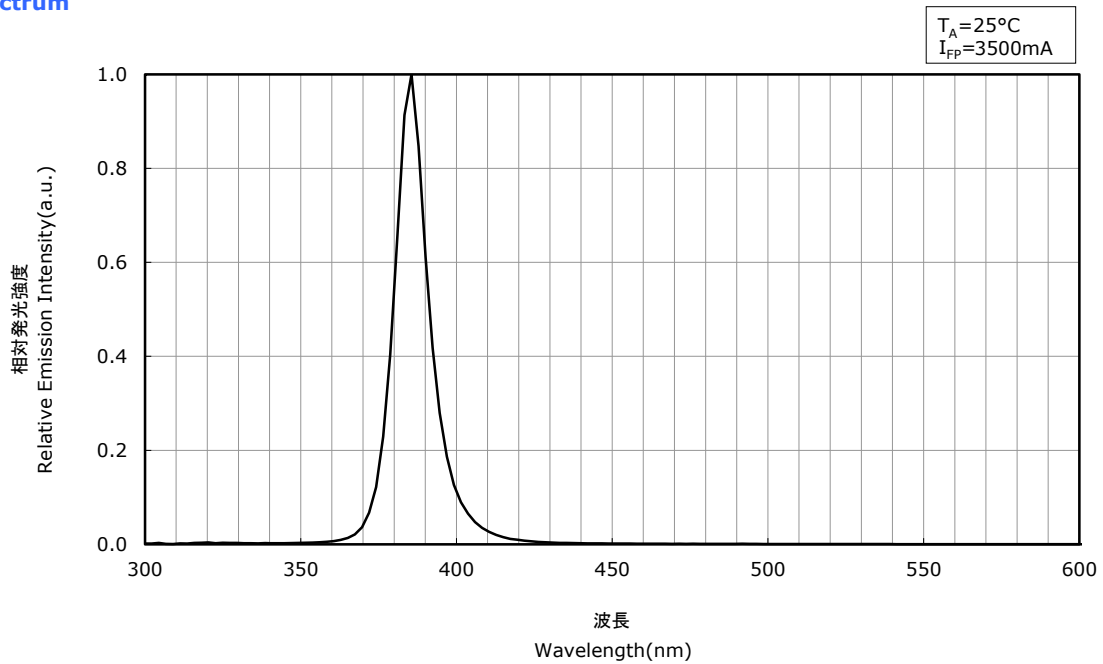

指向特性
Directivity

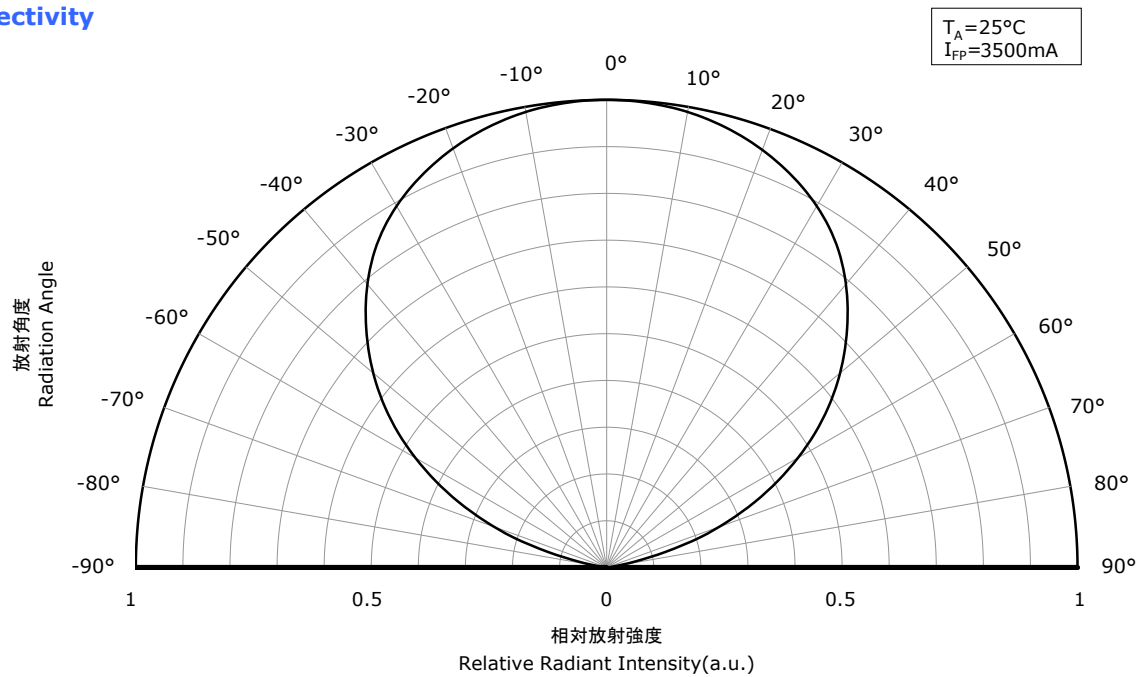

* 本特性はピーク波長ランクU385xに対応しています。
The graphs above show the characteristics for U385x LEDs of this product.

OPTICAL CHARACTERISTICS

* 本特性は参考です。
All characteristics shown are for reference only and are not guaranteed.

NVSU333A
管理番号 No. STS-DA7-6234A

発光スペクトル
Spectrum

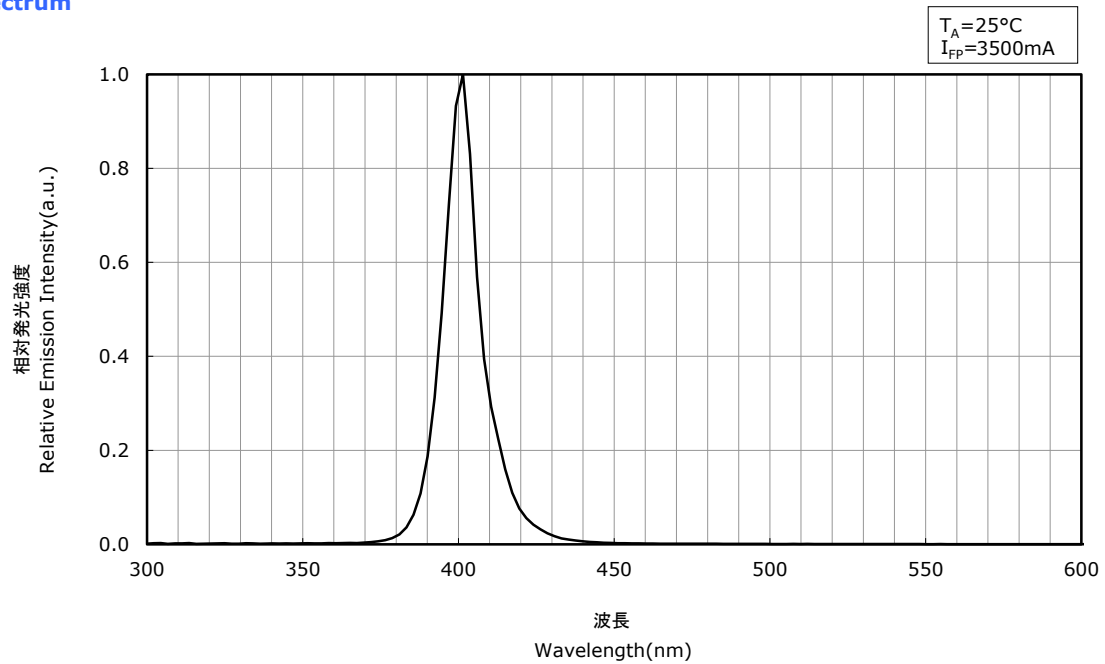

指向特性
Directivity

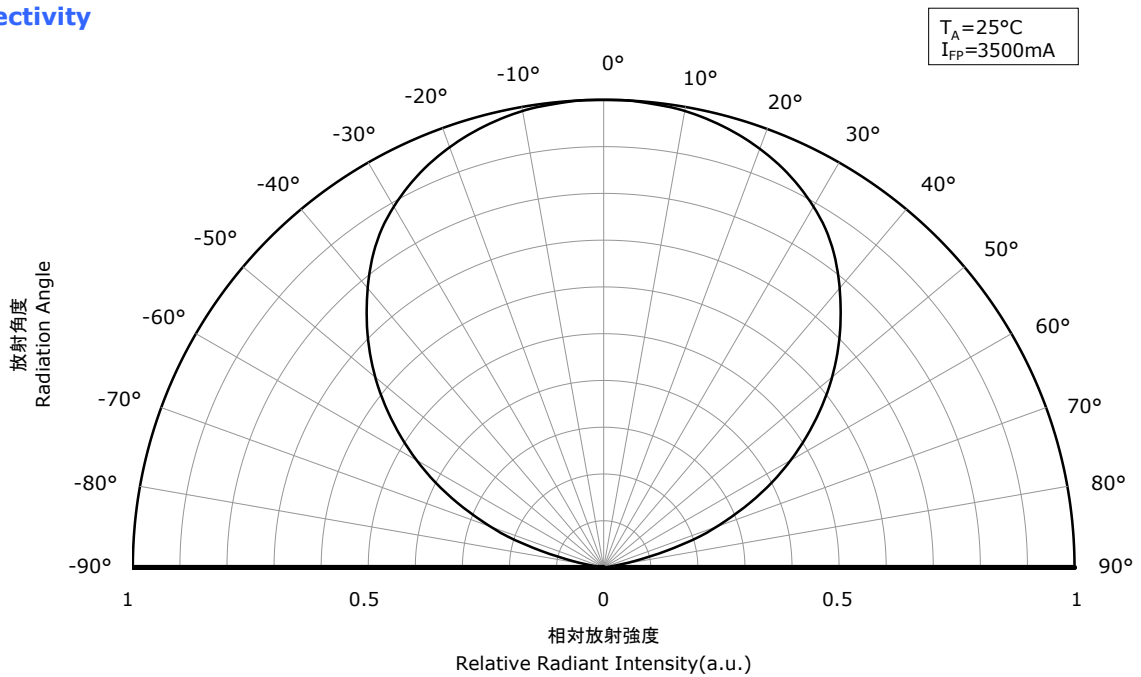

* 本特性はピーク波長ランクU405xに対応しています。
The graphs above show the characteristics for U405x LEDs of this product.

FORWARD CURRENT CHARACTERISTICS / TEMPERATURE CHARACTERISTICS

* 本特性は参考です。
All characteristics shown are for reference only and are not guaranteed.

NVSU333A
管理番号 No. STS-DA7-6235B

順電圧-順電流特性
Forward Voltage vs Forward Current

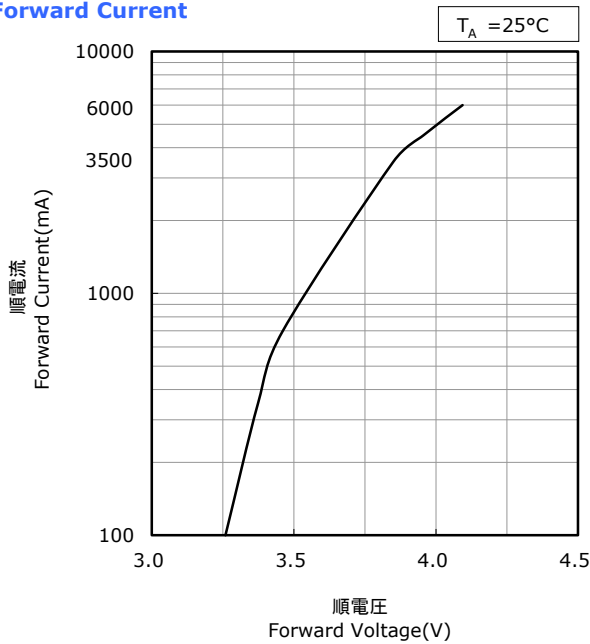

周囲温度-順電圧特性
Ambient Temperature vs Forward Voltage

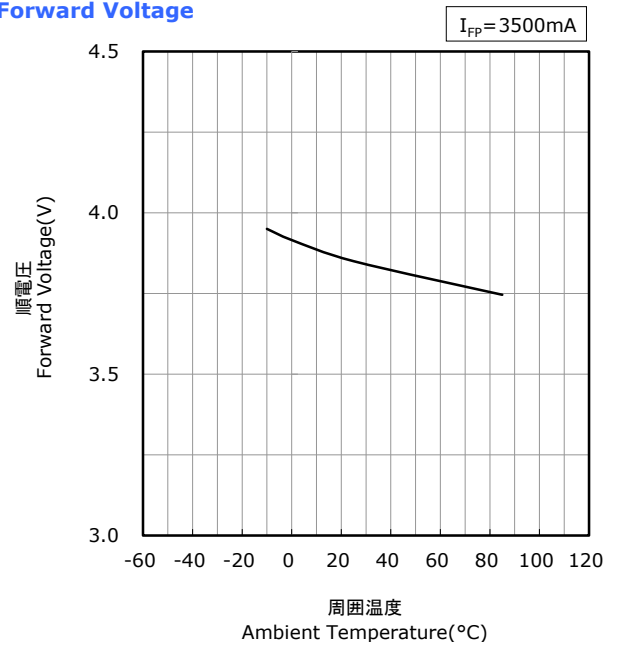

順電流-相対放射束特性
Forward Current vs Relative Radiant Flux

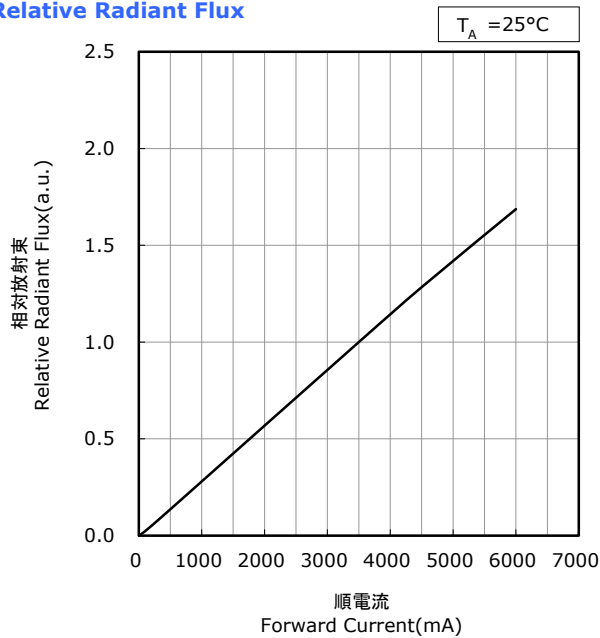

周囲温度-相対放射束特性
Ambient Temperature vs Relative Radiant Flux

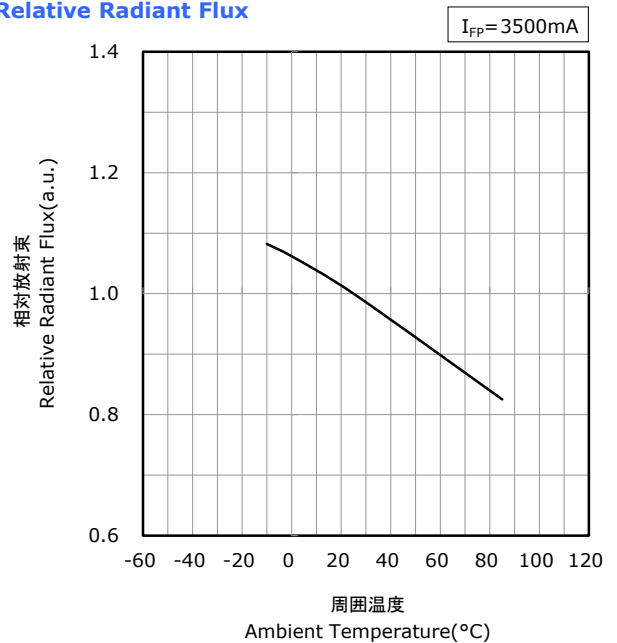

* 本特性はピーク波長ランクU365xに対応しています。
The graphs above show the characteristics for U365x LEDs of this product.

FORWARD CURRENT CHARACTERISTICS / TEMPERATURE CHARACTERISTICS

* 本特性は参考です。
All characteristics shown are for reference only and are not guaranteed.

NVSU333A
管理番号 No. STS-DA7-6236B

順電圧-順電流特性
Forward Voltage vs
Forward Current

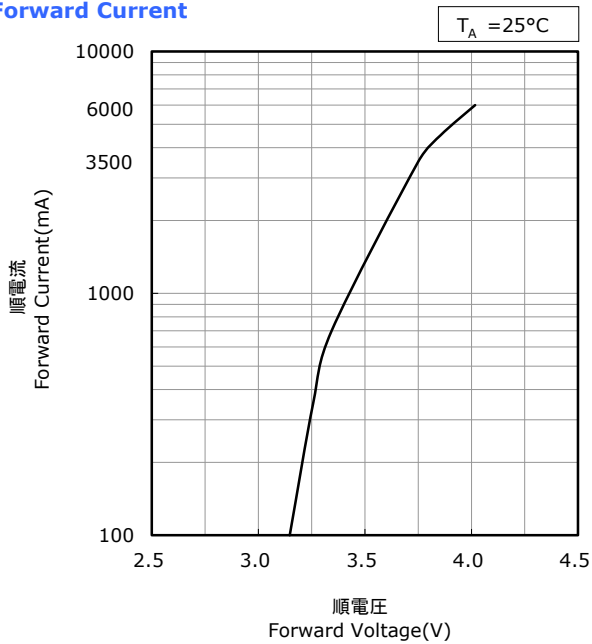

周囲温度-順電圧特性
Ambient Temperature vs
Forward Voltage

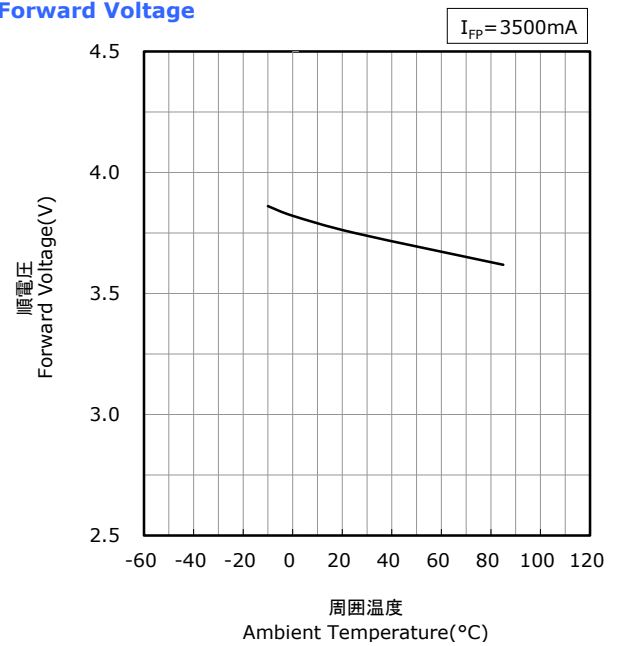

順電流-相対放射束特性
Forward Current vs
Relative Radiant Flux

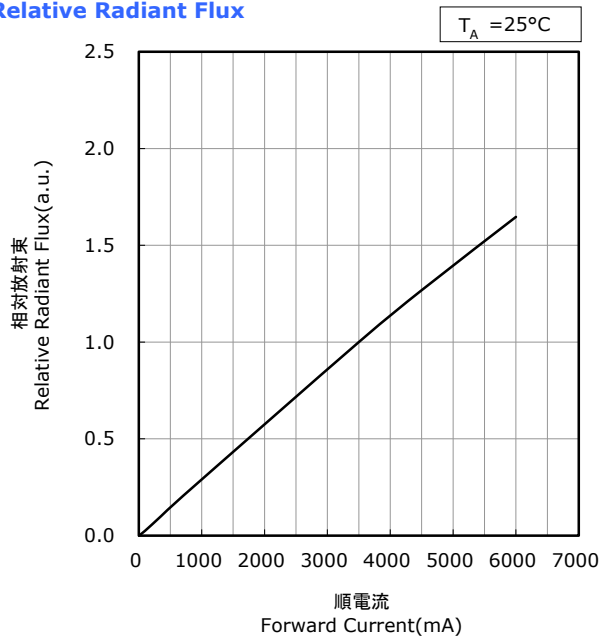

周囲温度-相対放射束特性
Ambient Temperature vs
Relative Radiant Flux

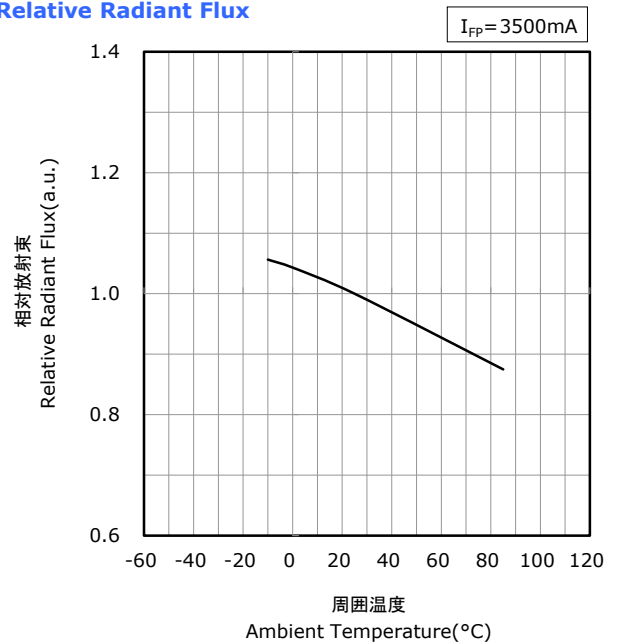

* 本特性はピーク波長ランクU385xに対応しています。
The graphs above show the characteristics for U385x LEDs of this product.

FORWARD CURRENT CHARACTERISTICS / TEMPERATURE CHARACTERISTICS

* 本特性は参考です。
All characteristics shown are for reference only and are not guaranteed.

NVSU333A
管理番号 No. STS-DA7-6237B

順電圧-順電流特性
Forward Voltage vs Forward Current

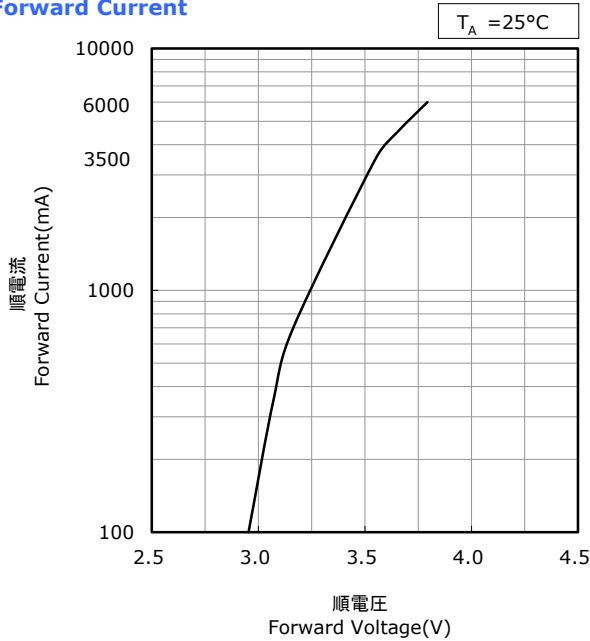

周囲温度-順電圧特性
Ambient Temperature vs Forward Voltage

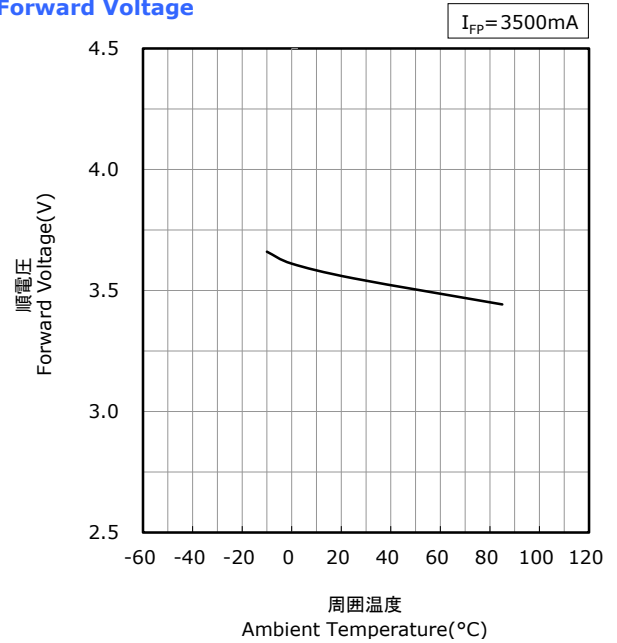

順電流-相対放射束特性
Forward Current vs Relative Radiant Flux

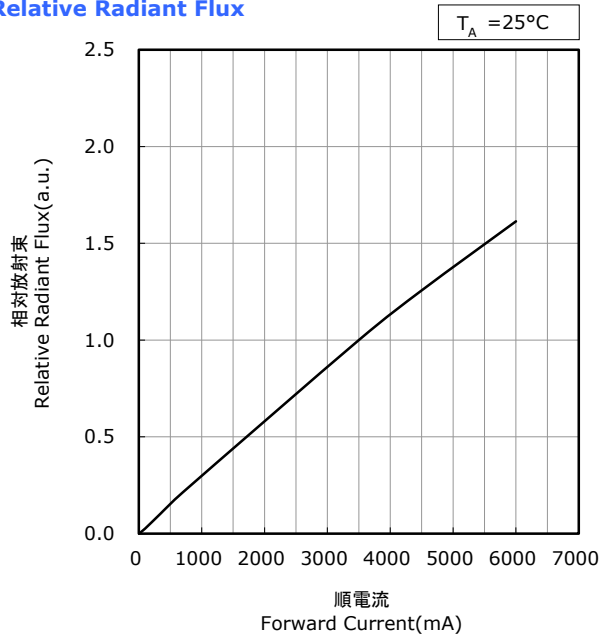

周囲温度-相対放射束特性
Ambient Temperature vs Relative Radiant Flux

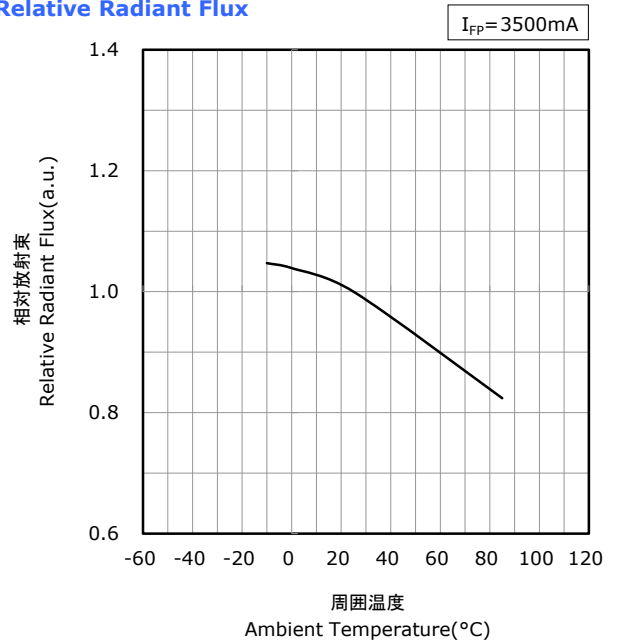

* 本特性はピーク波長ランクU405xに対応しています。
The graphs above show the characteristics for U405x LEDs of this product.

FORWARD CURRENT CHARACTERISTICS / TEMPERATURE CHARACTERISTICS

* 本特性は参考です。
All characteristics shown are for reference only and are not guaranteed.

NVSU333A
管理番号 No. STS-DA7-6238A

順電流-ピーク波長特性
Forward Current vs
Peak Wavelength

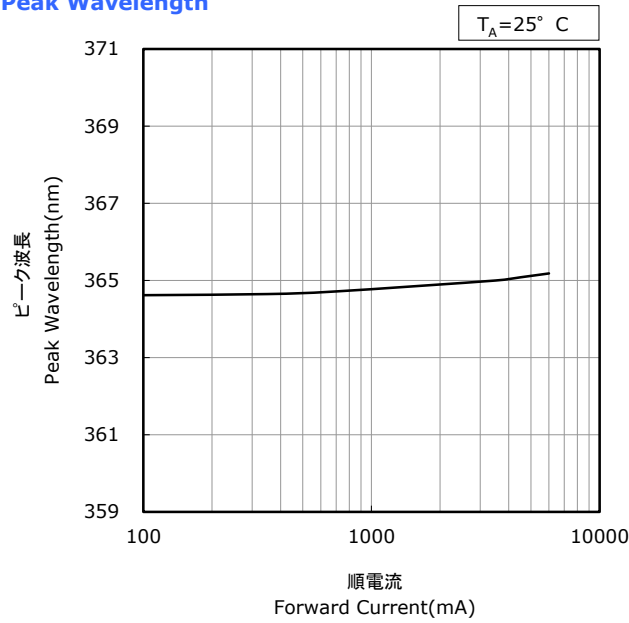

周囲温度-ピーク波長特性
Ambient Temperature vs
Peak Wavelength

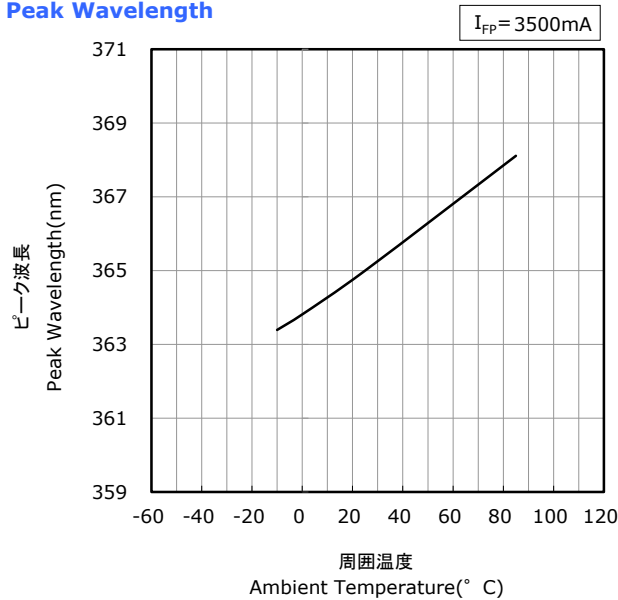

* 本特性はピーク波長ランクU365xに対応しています。
The graphs above show the characteristics for U365x LEDs of this product.

FORWARD CURRENT CHARACTERISTICS / TEMPERATURE CHARACTERISTICS

* 本特性は参考です。
All characteristics shown are for reference only and are not guaranteed.

NVSU333A
管理番号 No. STS-DA7-6239A

順電流-ピーク波長特性
Forward Current vs
Peak Wavelength

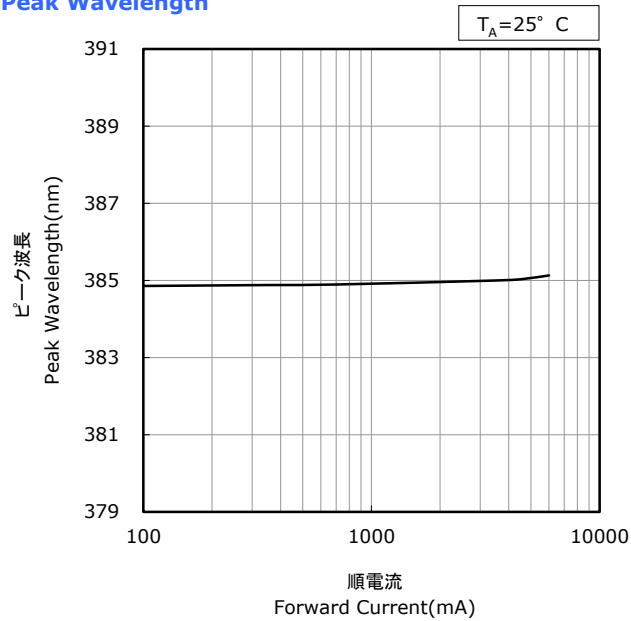

周囲温度-ピーク波長特性
Ambient Temperature vs
Peak Wavelength

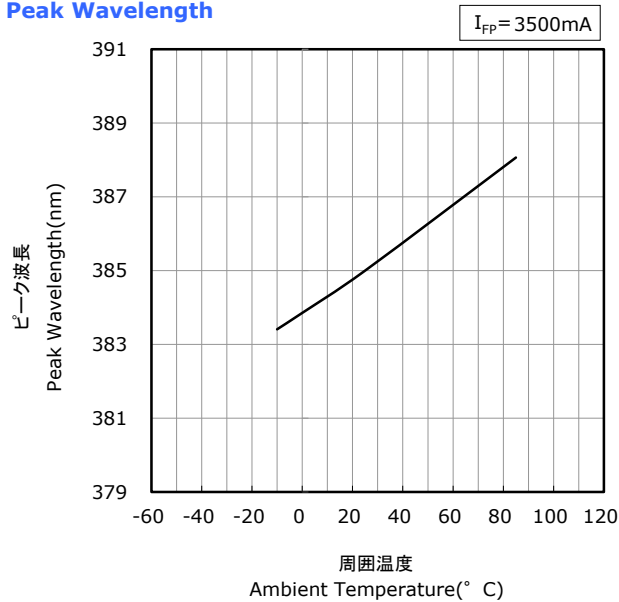

* 本特性はピーク波長ランクU385xに対応しています。
The graphs above show the characteristics for U385x LEDs of this product.

FORWARD CURRENT CHARACTERISTICS / TEMPERATURE CHARACTERISTICS

* 本特性は参考です。
All characteristics shown are for reference only and are not guaranteed.

NVSU333A
管理番号 No. STS-DA7-6240A

順電流-ピーク波長特性
Forward Current vs
Peak Wavelength

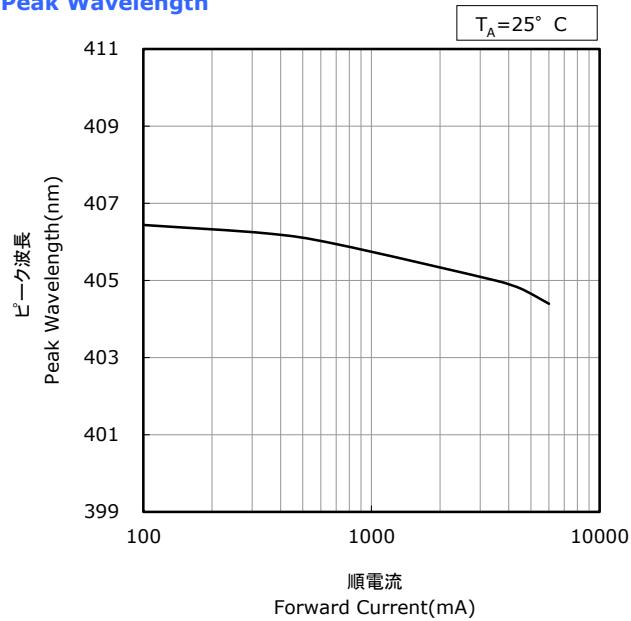

周囲温度-ピーク波長特性
Ambient Temperature vs
Peak Wavelength

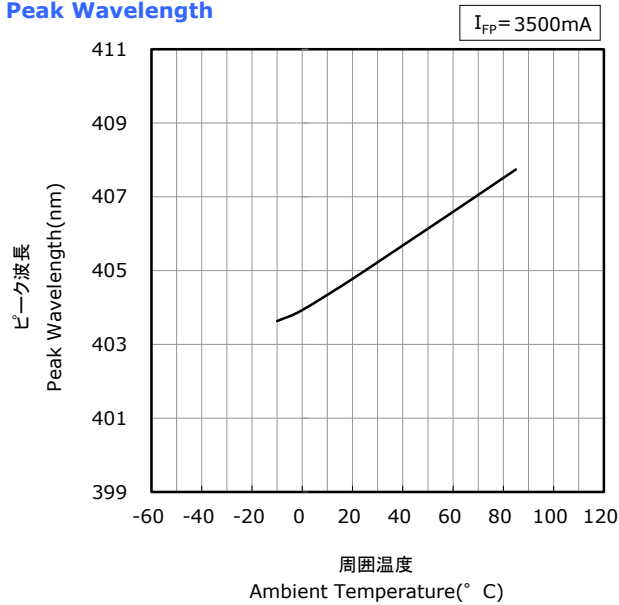

* 本特性はピーク波長ランクU405xに対応しています。
The graphs above show the characteristics for U405x LEDs of this product.

RELIABILITY

(1) Tests and Results

Test	Reference Standard	Test Conditions	Test Duration	Failure Criteria #	Units Failed/Tested
Resistance to Soldering Heat (Reflow Soldering)	JEITA ED-4701 300 301	$T_{\text{slid}}=260^{\circ}\text{C}$, 10sec, 2reflows, Precondition: 30°C , 70%RH, 168hr		#1	0/10
Temperature Cycle	JEITA ED-4701 100 105	$-40^{\circ}\text{C}(30\text{min})\sim 25^{\circ}\text{C}(5\text{min})\sim 100^{\circ}\text{C}(30\text{min})\sim 25^{\circ}\text{C}(5\text{min})$	100cycles	#1	0/10
High Temperature Storage	JEITA ED-4701 200 201	$T_A=100^{\circ}\text{C}$	1000hours	#1	0/10
Low Temperature Storage	JEITA ED-4701 200 202	$T_A=-40^{\circ}\text{C}$	1000hours	#1	0/10
Room Temperature Operating Life		$T_A=25^{\circ}\text{C}$, $T_S=50^{\circ}\text{C}$, $I_F=4500\text{mA}$	1000hours	#1	0/10
Temperature Humidity Operating Life		60°C , RH=90%, $I_F=3500\text{mA}$	500hours	#1	0/10
Vibration	JEITA ED-4701 400 403	200m/s^2 , 100~2000~100Hz, 4cycles, 4min, each X, Y, Z	48minutes	#1	0/10
Electrostatic Discharges	JEITA ED-4701 300 304	HBM, 2kV, 1.5k Ω , 100pF, 3pulses, alternately positive or negative		#1	0/10

NOTES:

- 1) $R_{\theta JA} \approx 2.8^{\circ}\text{C/W}$
- 2) Measurements are performed after allowing the LEDs to return to room temperature.

(2) Failure Criteria

Criteria #	Items	Conditions	Failure Criteria
#1	Forward Voltage(V_F)	$I_F=3500\text{mA}$	>Initial value $\times 1.1$
	Radiant Flux(Φ_E)	$I_F=3500\text{mA}$	<Initial value $\times 0.7$

CAUTIONS

(1) Storage

Conditions		Temperature	Humidity	Time
Storage	Before Opening Aluminum Bag	≤30°C	≤90%RH	Within 1 Year from Delivery Date
	After Opening Aluminum Bag	≤30°C	≤70%RH	≤168hours
Baking		65±5°C	-	≥24hours

- The storage/packaging requirements for this LED are comparable to JEDEC Moisture Sensitivity Level (MSL) 3 or equivalent. Nichia used IPC/JEDEC STD-020 as a reference to rate the MSL of this LED.
- This LED uses a package that could absorb moisture; if the package absorbs moisture and is exposed to heat during soldering, it may cause the moisture to vaporize and the package to expand and the resulting pressure may cause internal delamination. This may cause the optical characteristics to degrade. To minimize moisture absorption in storage/transit, moisture-proof aluminum bags are used for the LEDs with a silica gel packet to absorb any air moisture in the bag. The silica gel beads turn blue to red as they absorb moisture.
- Once the moisture-proof aluminum bag is open, ensure that the LED is soldered to a PCB within the range of the conditions above. To store any remaining unused LEDs, use a hermetically sealed container with silica gel desiccants. Nichia recommends placing them back to the original moisture-proof bag and reseal it.
- If the "After Opening" storage time has been exceeded or any pink silica gel beads are found, ensure that the LED are baked before use. Baking should only be done once.
- This LED has gold-plated electrodes. If the LEDs are exposed to a corrosive environment, it may cause the plated surface to tarnish causing issues (i.e. solderability). Ensure that when storing LEDs, a hermetically sealed container is used. Nichia recommends placing them back to the original moisture-proof bag and reseal it.
- To prevent substances/gases from affecting the plated surface, ensure that the parts/materials used with the LEDs in the same assembly/system do not contain sulfur (e.g. gasket/seal, adhesive, etc.). If the plating is contaminated, it may cause issues (e.g. electric connection failures). If a gasket/seal is used, silicone rubber gaskets/seals are recommended; ensure that this use of silicone does not result in issues (e.g. electrical connection failures) caused by low molecular weight volatile siloxane.
- To avoid condensation, the LEDs must not be stored in areas where temperature and humidity fluctuate greatly.
- Do not store the LEDs in a dusty environment.
- Do not expose the LEDs to direct sunlight and/or an environment over a long period of time where the temperature is higher than normal room temperature.

(2) Directions for Use

- The circuit must be designed to ensure that the Absolute Maximum Ratings are not exceeded for each LED. The LEDs should be operated at a constant current per LED. In the case of operating at a constant voltage, Circuit B is recommended. If Circuit A is used, it may cause the currents flowing through the LEDs to vary due to the variation in the forward voltage characteristics of the LEDs on the circuit.

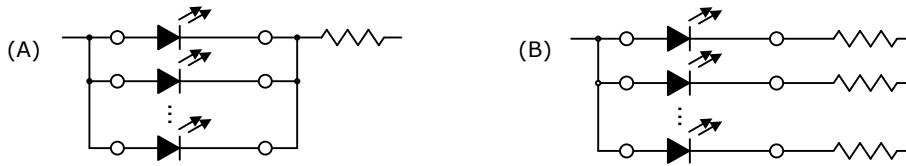

- This LED is designed to be operated at a forward current. Ensure that no voltage is applied to the LED in the forward/reverse direction while the LED is off. If the LEDs are used in an environment where reverse voltages are applied to the LED continuously, it may cause electrochemical migration to occur causing the LED to be damaged. When not in use for a long period of time, the system's power should be turned off to ensure that there are no issues/damage.
- To stabilize the LED characteristics while in use, Nichia recommends that the LEDs are operated at currents $\geq 10\%$ of the sorting current.
- Ensure that transient excessive voltages (e.g. lighting surge) are not applied to the LEDs.
- If the LEDs are used for outdoor applications, ensure that necessary measures are taken (e.g. protecting the LEDs from water/salt damage and high humidity).
- Although this LED is specifically designed to emit invisible light, a small amount of light in the visible region exists in the emission spectrum. Ensure that when using the LEDs for sensors, verification is performed to ensure that the emission spectrum is fit for the intended use.
- If this LED is stored and/or used constantly under high temperature and high humidity conditions, it may accelerate the deterioration of the die; this may cause the radiant flux to decrease. If the LEDs are stored and/or used under these conditions, sufficient verification must be done prior to use to ensure that there are no issues for the chosen application.

(3) Handling Precautions

- Do not handle the LEDs with bare hands:
 - this may contaminate the LED surface and have an effect on the optical characteristics,
 - this may cause the LED to deform and/or the wire to break causing a catastrophic failure (i.e. the LED not to illuminate).
- When handling the product with tweezers, be careful not to apply excessive force to the glass. Otherwise, The glass can be cut, chipped, delaminate or deformed, causing wire-bond breaks and catastrophic failures.
- Dropping may cause damage to the LED (e.g. deformation).
- Do not stack assembled PCBs together. Otherwise, it may cause damage to the glass cover (e.g. cut, scratch, chip, crack, delamination and deformation) and the wire to break causing a catastrophic failure (i.e. the LED not to illuminate).

(4) Design Consideration

- To operate the LEDs, using a copper-core PCB is recommended; this may cause issues (e.g. cracks in the glass cover/solder joints due to thermal stress) depending on the reflow soldering conditions. Ensure that sufficient verification is performed prior to use to ensure that there are no issues with the PCB/soldering conditions for the chosen application.
- If the LEDs are soldered to a PCB and the PCB assembly is bent (e.g. PCB depaneling process), it may cause the LED package to break. The PCB layout should be designed to minimize the mechanical stress on the LEDs when the PCB assembly is bent/warped.
- The amount of mechanical stress exerted on the LED from depaneling may vary depending on the LED position/orientation on the PCB assembly (e.g. especially in areas near V-groove scores). The PCB layout should be designed to minimize the mechanical stress on the LEDs when the PCB is separated into individual PCB assemblies.
- To separate a PCB populated with the LEDs, use a specially designed tool. Do not break the PCB by hand.
- If an aluminum-core PCB is used to operate the LEDs, it may cause thermal stress during operation causing damage to the solder joints (e.g. crack). Ensure that sufficient verification is performed prior to use.
- Volatile organic compounds that have been released from materials present around the LEDs (e.g. housing, gasket/seal, adhesive, secondary lens, lens cover, thermal grease, etc.) may adhere to the LED glass cover and other areas (e.g. package). If the LEDs are being used in a hermetically sealed environment, these volatile compounds can discolor after being exposed to heat and/or photon energy and it may greatly reduce the LED light output. In this case, ventilating the environment may improve the reduction in light output. Perform a light-up test of the chosen application for optical evaluation to ensure that there are no issues.

(5) Electrostatic Discharge (ESD)

- This LED is sensitive to transient excessive voltages (e.g. ESD, lightning surge). If this excessive voltage occurs in the circuit, it may cause the LED to be damaged causing issues (e.g. the LED to have a reduction in the radiant flux or not to illuminate [i.e. catastrophic failure]).
Ensure that when handling the LEDs, necessary measures are taken to protect them from an ESD discharge. The following examples are recommended measures to eliminate the charge:
 - Grounded wrist strap, ESD footwear, clothes, and floors
 - Grounded workstation equipment and tools
 - ESD table/shelf mat made of conductive materials
- Ensure that all necessary measures are taken to prevent the LEDs from being exposed to transient excessive voltages (e.g. ESD, lightning surge):
 - tools, jigs, and machines that are used are properly grounded
 - appropriate ESD materials/equipment are used in the work area
 - the system/assembly is designed to provide ESD protection for the LEDs
- If the tool/equipment used is an insulator (e.g. glass cover, plastic, etc.), ensure that necessary measures have been taken to protect the LED from transient excessive voltages (e.g. ESD). The following examples are recommended measures to eliminate the charge:
 - Dissipating static charge with conductive materials
 - Preventing charge generation with moisture
 - Neutralizing the charge with ionizers
- To detect if an LED was damaged by transient excess voltages (i.e. an ESD event during the system's assembly process), perform a characteristics inspection (e.g. forward voltage measurement) at low current ($\leq 1\text{mA}$).
- Failure Criteria: $V_F < 2.0\text{V}$ at $I_F = 0.5\text{mA}$
If the LED is damaged by transient excess voltages (e.g. ESD), it will cause the Forward Voltage (V_F) to decrease.

(6) Thermal Management

- The Absolute Maximum Junction Temperature (T_J) must not be exceeded under any circumstances. The increase in the temperature of an LED while in operation may vary depending on the PCB thermal resistance and the density of LEDs on the PCB assembly. Ensure that when using the LEDs for the chosen application, heat is not concentrated in an area and properly managed in the system/assembly.
- The operating current should be determined by considering the temperature conditions surrounding the LED (i.e. T_A). Ensure that when operating the LED, proper measures are taken to dissipate the heat.
- The following two equations can be used to calculate the LED junction temperature:

$$1) T_J = T_A + R_{\theta JA} \cdot W \quad 2) T_J = T_S + R_{\theta JS} \cdot W$$

* T_J = LED Junction Temperature: °C

T_A = Ambient Temperature: °C

T_S = Soldering Temperature (Die Heat Sink): °C

$R_{\theta JA}$ = Thermal Resistance from Junction to Ambient: °C/W

$R_{\theta JS}$ = Thermal Resistance from Junction to T_S Measurement Point: °C/W

W = Input Power ($I_F \times V_F$): W

T_S Measurement Point

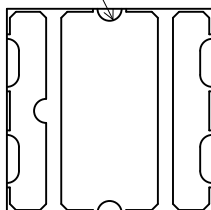

(7) Cleaning

- Do not clean the LEDs. If the LED is cleaned, it may cause damage to the package/glass cover causing issues; ensure that if the LEDs are cleaned, sufficient verification is performed prior to use. Additionally, ensure that the solvent being used does not cause any other issues (e.g. CFC-based solvents are heavily regulated).
- Do not clean the LEDs with an ultrasonic cleaner. If cleaning must be done, ensure that sufficient verification is performed by using a finished assembly with LEDs to determine cleaning conditions (e.g. ultrasonic power, LED position on the PCB assembly) that do not cause an issue.

(8) Eye Safety

- There may be two important international specifications that should be noted for safe use of the LEDs: IEC 62471:2006 Photobiological safety of lamps and lamp systems and IEC 60825-1:2001 (i.e. Edition 1.2) Safety of Laser Products - Part 1: Equipment Classification and Requirements. Ensure that when using the LEDs, there are no issues with the following points:
 - LEDs have been removed from the scope of IEC 60825-1 since IEC 60825-1:2007 (i.e. Edition 2.0) was published. However, depending on the country/region, there are cases where the requirements of the IEC 60825-1:2001 specifications or equivalent must be adhered to.
 - LEDs have been included in the scope of IEC 62471:2006 since the release of the specification in 2006.
 - Most Nichia LEDs will be classified as the Exempt Group or Risk Group 1 according to IEC 62471:2006. However, in the case of high-power LEDs containing blue wavelengths in the emission spectrum, there are LEDs that will be classified as Risk Group 2 depending on the characteristics (e.g. radiation flux, emission spectrum, directivity, etc.)
 - If the LED is used in a manner that produces an increased output or with an optic to collimate the light from the LED, it may cause damage to the human eye.
- If an LED is operated in a manner that emits a flashing light, it may cause health issues (e.g. visual stimuli causing eye discomfort). The system should be designed to ensure that there are no harmful effects on the human body.
- This LED emits light in the ultraviolet (UV) region. The UV light from an LED while in operation is intense and harmful; if human eyes are exposed to this light, it may cause damage to them. Do not look directly or indirectly (e.g. through an optic) at the UV light. Ensure that if there is a possibility that the UV light reflects off objects and enters the eyes, appropriate protection gear (e.g. goggles) is used to prevent the eyes from being exposed to the light.
- Ensure that appropriate warning signs/labels are provided both on each of the systems/applications using the UV LEDs, in all necessary documents (e.g. specification, manual, catalogs, etc.), and on the packaging materials.

(9) Miscellaneous

- Nichia warrants that the discrete LEDs will meet the requirements/criteria as detailed in the Reliability section within this specification. If the LEDs are used under conditions/environments deviating from or inconsistent with those described in this specification, the resulting damage and/or injuries will not be covered by this warranty.
- Nichia warrants that the discrete LEDs manufactured and/or supplied by Nichia will meet the requirements/criteria as detailed in the Reliability section within this specification; it is the customer's responsibility to perform sufficient verification prior to use to ensure that the lifetime and other quality characteristics required for the intended use are met.
- The applicable warranty period is one year from the date that the LED is delivered. In the case of any incident that appears to be in breach of this warranty, the local Nichia sales representative should be notified to discuss instructions on how to proceed while ensuring that the LED in question is not disassembled or removed from the PCB if it has been attached to the PCB. If a breach of this warranty is proved, Nichia will provide the replacement for the non-conforming LED or an equivalent item at Nichia's discretion. FOREGOING ARE THE EXCLUSIVE REMEDIES AVAILABLE TO THE CUSTOMER IN RESPECT OF THE BREACH OF THE WARRANTY CONTAINED HEREIN, AND IN NO EVENT SHALL NICHIA BE RESPONSIBLE FOR ANY INDIRECT, INCIDENTAL OR CONSEQUENTIAL LOSSES AND/OR EXPENSES (INCLUDING LOSS OF PROFIT) THAT MAY BE SUFFERED BY THE CUSTOMER ARISING OUT OF A BREACH OF THE WARRANTY.
- NICHIA DISCLAIMS ALL OTHER WARRANTIES, EXPRESS OR IMPLIED, INCLUDING THE IMPLIED WARRANTIES OF MERCHANTABILITY AND FITNESS FOR A PARTICULAR PURPOSE.
- This LED is intended to be used for general lighting, household appliances, electronic devices (e.g. mobile communication devices); it is not designed or manufactured for use in applications that require safety critical functions (e.g. aircraft, automobiles, combustion equipment, life support systems, nuclear reactor control system, safety devices, spacecraft, submarine repeaters, traffic control equipment, trains, vessels, etc.). If the LEDs are planned to be used for these applications, unless otherwise detailed in the specification, Nichia will neither guarantee that the LED is fit for that purpose nor be responsible for any resulting property damage, injuries and/or loss of life/health. This LED does not comply with IATF 16949 and is not intended for automotive applications.
- The customer will not reverse engineer, disassemble or otherwise attempt to extract knowledge/design information from the LED.
- All copyrights and other intellectual property rights in this specification in any form are reserved by Nichia or the right holders who have granted Nichia permission to use the content. Without prior written permission from Nichia, no part of this specification may be reproduced in any form or by any means.
- Both the customer and Nichia will agree on the official specifications for the supplied LEDs before any programs are officially launched. Without this agreement in writing (i.e. Customer Specific Specification), changes to the content of this specification may occur without notice (e.g. changes to the foregoing specifications and appearance, discontinuation of the LEDs, etc.).

Handling Precautions for the UV LEDs

Assembly Precautions

Please use the pick-and-place nozzle not to apply stress to the glass.
When the stress is directly applied to the glass, it can get damaged, chipped, and detached from the package, resulting in the defect. Please verify the nozzle before use.

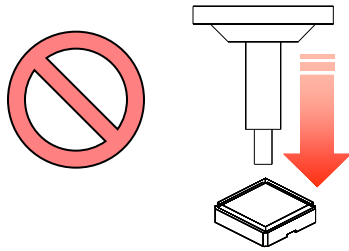

Do NOT apply stress to the glass.

Handling Precautions

Please do not handle the LEDs with bare hands, otherwise, the emitting surface will get contaminated, affecting the optical characteristics.
Also, the glass is sharp-edged, possibly causing injury.
When dropped, the glass/ceramics/wire can get damaged.

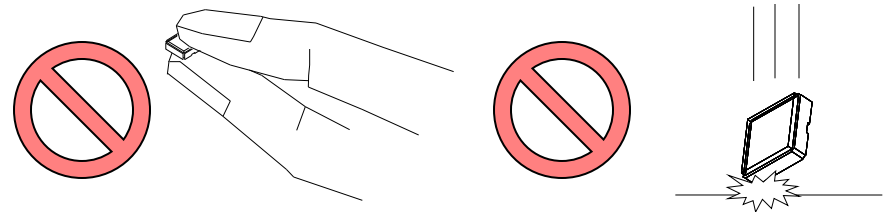

Do NOT handle the LEDs with bare hands. Do NOT drop the LEDs.

Handling Precautions with Tweezers

Nichia recommends that vacuum tweezers should be used.
Please pick up the upper part of the glass with the tweezers.
Please do not touch the glass except when you pick up the LEDs.
Also, please refrain from applying excessive stress to the LEDs, otherwise, the glass and the ceramics will get chipped and detached from the package, resulting in the defect.

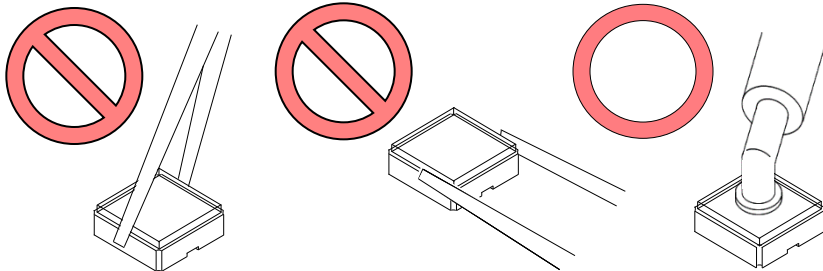

Precautions for Assembled Products

Do not pile up the boards with LEDs mounted on.
When the boards are piled up, the glass will get damaged, resulting in the scratch, chip, and detachment of the glass, leading to the defect.

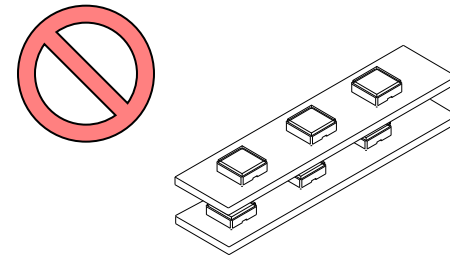

Do NOT pile up the boards.