

DATA SHEET



NEC's 1310 nm InGaAsP MQW-FP LASER DIODE IN CAN PACKAGE FOR 155 Mb/s, 622 Mb/s AND 1.25 Gb/s APPLICATIONS

NX5304 Series

FEATURES

- **OPTICAL OUTPUT POWER**
P_o = 5.0 mW
- **LOW THRESHOLD CURRENT**
I_{th} = 10 mA
- **HIGH SPEED**
t_r = 0.3 ns MAX
t_f = 0.3 ns MAX
- **WIDE OPERATING TEMPERATURE RANGE**
T_c = -40 to +85°C
- **InGaAs MONITOR PIN-PD**
- **CAN PACKAGE**
ø5.6 mm
- **FIBER COUPLING POINT**
5.8 mm
- **BASED ON TELCORDIA RELIABILITY**



DESCRIPTION

NEC's NX5304 Series is a 1310 nm Multiple Quantum Well (MQW) structured Fabry-Perot (FP) laser diodes with InGaAs monitor PIN-PD. These devices are designed for 155 Mb/s: STM-1 (I-1, S-1.1, L-1.1), 622 Mb/s: STM-4 (I-4, S-4.1) application and ideal for Synchronous Digital Hierarchy (SDH) system.

ELECTRO-OPTICAL CHARACTERISTICS (T_c = 25°C, unless otherwise specified)

SYMBOL	PARAMETER AND CONDITIONS	UNIT	NX5304 SERIES		
			MIN.	TYP.	MAX.
V _{op}	Operating Voltage, P _o = 5.0 mW, T _c = -40 to +85°C	V		1.1	1.5
I _{th}	Threshold Current T _c = 85°C	mA		10	15
				25	30
P _{th}	Threshold Output Power, T _c = -40 to +85°C, I _F = I _{th}	μW		100	200
η _d	Differential Efficiency	W/A	0.32	0.4	
Δη _d	Temperature Dependence of Differential Efficiency η _d = 10 log $\frac{\eta_d (@ 85^\circ\text{C})}{\eta_d (@ 25^\circ\text{C})}$	dB	-3.0	-1.2	
λ _c	Center Wavelength, P _o = 5.0 mW, RMS (-20 dB), T _c = -40 to +85°C	nm	1 263		1 360
Δλ/ΔT	Temperature Dependence of Center Wavelength, T _c = -40 to +85°C	nm/°C		0.4	0.5
σ	Spectral Width, P _o = 5.0 mW, RMS (-20 dB), T _c = -40 to +85°C	nm		1.0	2.5
t _r	Rise Time, 10-90%	ns		0.15	0.3
t _f	Fall Time, 90-10%	ns		0.15	0.3
I _m	Monitor Current, V _R = 5 V, P _o = 5.0 mW	μA	200	500	800
I _d	Monitor Dark Current, V _R = 5 V	nA		0.1	10
	V _R = 5 V, T _c = -40 to +85°				500
C _t	Monitor PD Terminal Capacitance, V _R = 5 V, f = 1 MHz	pF		6	20
γ	Tracking Error [†] , I _m = const. (@ P _o = 5.0 mW, T _c = 25°C), T _c = -40 to +85°C	dB	-1.0		1.0

Notes continued on next page

*1 Tracking Error: γ

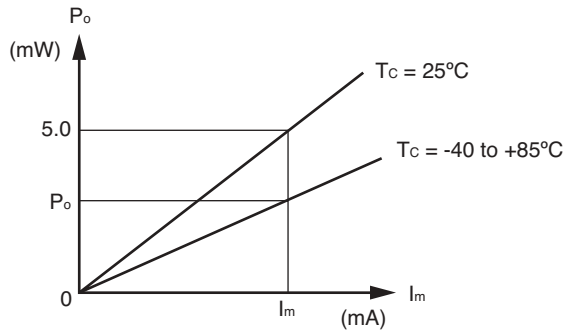

$$\gamma = \left| 10 \log \frac{P_o}{5.0} \right| \text{ [dB]}$$

ABSOLUTE MAXIMUM RATINGS

SYMBOL	PARAMETER	UNIT	RATINGS
P _o	Optical Output Power from Fiber	mW	10
I _F	Forward Current of LD	mA	150
V _R	Reverse Voltage of LD	V	2.0
I _F	Forward Current of PD	mA	10
V _R	Reverse Voltage of PD	V	20
T _c	Operating Case Temperature	°C	-40 to +85
T _{stg}	Storage Temperature	°C	-40 to +85
T _{asb}	Assembly Temperature	°C	150 (15 Hr.)
T _{slid}	Lead Soldering Temperature	°C	350 (3 sec.)
RH	Relative Humidity (noncondensing)	%	85

TYPICAL CHARACTERISTICS ($T_c = -40$ to $+85^\circ\text{C}$, unless otherwise specified)

OPTICAL OUTPUT POWER vs. FORWARD CURRENT

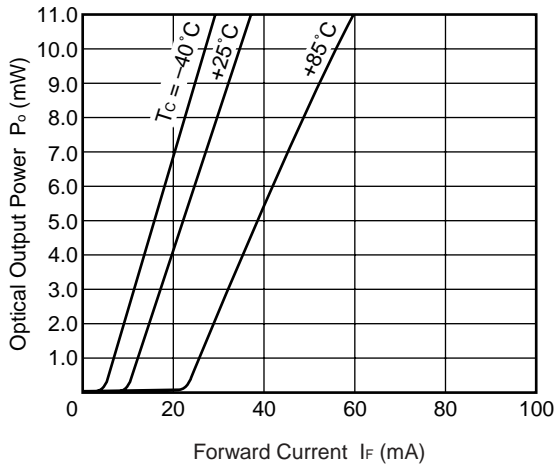

OPERATING CURRENT AND THRESHOLD CURRENT vs. CASE TEMPERATURE

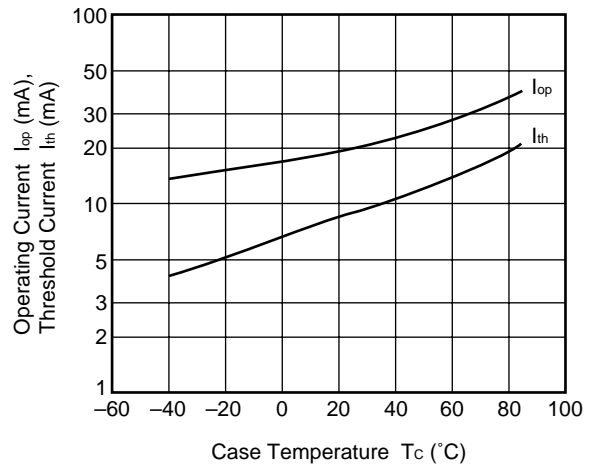

TEMPERATURE DEPENDENCE OF CENTER WAVELENGTH

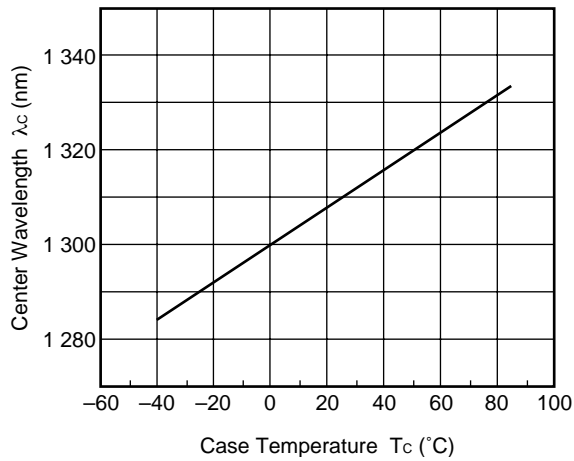

Remark The graphs indicate nominal characteristics.

TYPICAL CHARACTERISTICS ($T_c = 25^\circ\text{C}$, unless otherwise specified)

FORWARD CURRENT vs. FORWARD VOLTAGE

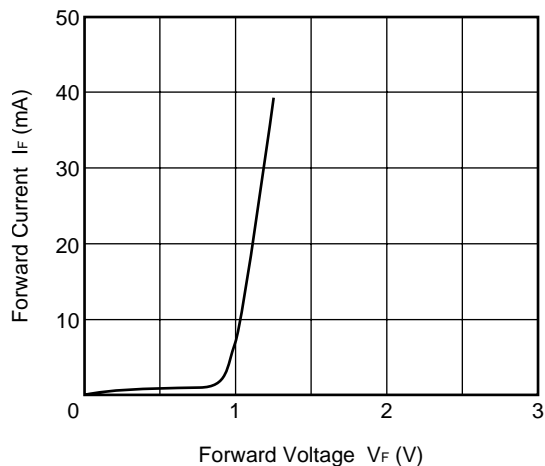

OPTICAL OUTPUT POWER vs. MONITOR CURRENT

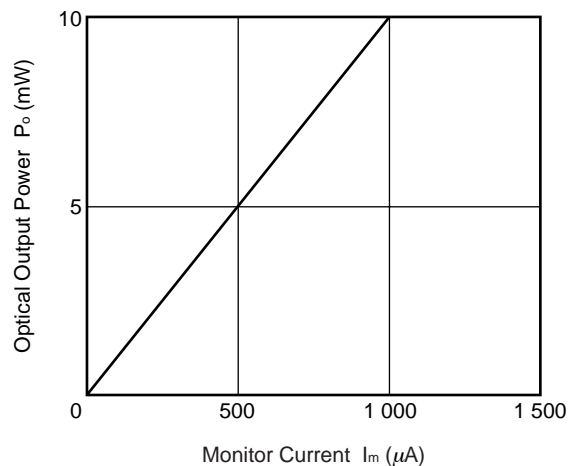

SPECTRUM

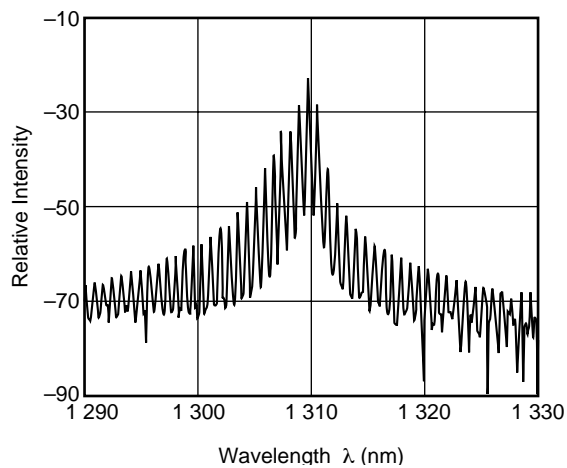

TOLERANCE OF FIBER COUPLING DISTANCE (Z)

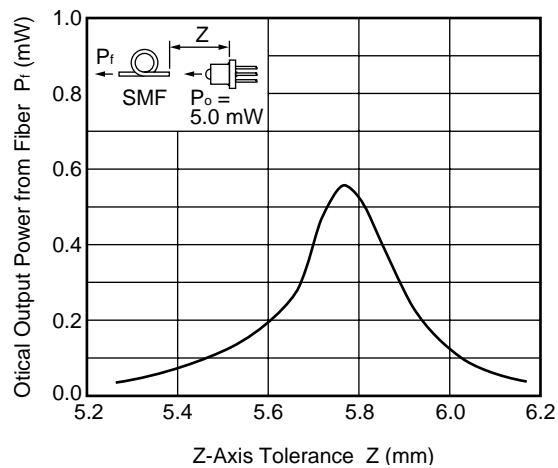

Remark The graphs indicate nominal characteristics.

PACKAGE DIMENSIONS (Units in mm)

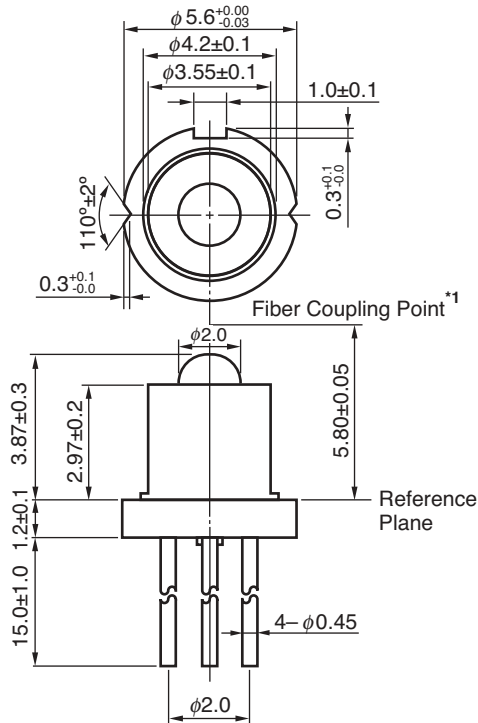

BOTTOM VIEW

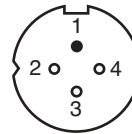

PIN CONNECTIONS

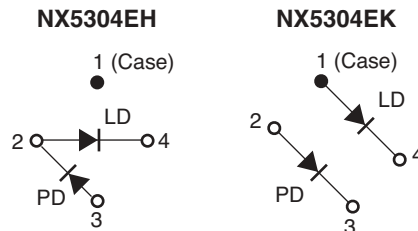

- *1 Recommendation of Fiber Coupling Conditions**
 Fiber : SMF with 8 degree angle-polished ferrule
 Fiber coupling distance : 5.80±0.05 mm from reference plane.
 Fiber coupling alignment : optimixed x, y, θ ($\Delta x, \Delta y \leq \pm 300 \mu\text{m}$).

ORDERING INFORMATION

Part Number	Package	Pin Connections
NX5304EH	4-pin CAN with ball lens cap	
NX5304EK		

- Remarks 1.** The color of ball lens cap might be observed differently from our can package products.
2. The hermetic test will be performed as AQL 1.0%.

Life Support Applications

These NEC products are not intended for use in life support devices, appliances, or systems where the malfunction of these products can reasonably be expected to result in personal injury. The customers of CEL using or selling these products for use in such applications do so at their own risk and agree to fully indemnify CEL for all damages resulting from such improper use or sale.

CEL California Eastern Laboratories, Your source for NEC RF, Microwave, Optoelectronic, and Fiber Optic Semiconductor Devices.
 4590 Patrick Henry Drive • Santa Clara, CA 95054-1817 • (408) 988-3500 • FAX (408) 988-0279 • www.cel.com

DATA SUBJECT TO CHANGE WITHOUT NOTICE

02/12/2004