



NEC's 1310 nm InGaAsP MQW FP TOSA FOR GIGABIT ETHERNET APPLICATION

NX7313UA

FEATURES

- **OPTICAL OUTPUT POWER:**
P_f = 0.6 mW
- **LOW THRESHOLD CURRENT**
I_{th} = 8 mA TYP @ T_c = 25°C
- **WIDE OPERATING TEMPERATURE RANGE:**
-40 to +85°C
- **InGaAs MONITOR PIN-PD**
- **SMALL PACKAGE**
ø3.8 mm (total length 12.0 mm MAX)
- **BASED ON TELCORDIA RELIABILITY GR-468-CORE**

DESCRIPTION

NEC's NX7313UA is a 1310 nm Multiple Quantum Well (MQW) structured Fabry-Perot (FP) laser diode transmitter optical subassembly (TOSA) with InGaAs monitor PIN-PD in a receptacle type package designed for LC type SFF/SFP transceiver modules. These devices are ideal for Gigabit Ethernet.

ELECTRO-OPTICAL CHARACTERISTICS (T_c = -40 to +85°C, unless otherwise specified)

PART NUMBER			NX7313UA		
SYMBOLS	PARAMETERS AND CONDITIONS	UNITS	MIN	TYP	MAX
V _{OP}	Operating Voltage, CW, P _f = 0.6 mW	V	–	1.2	1.5
I _{TH}	Threshold Current	CW, T _c = 25°C	mA	4	20
		CW	mA	2	50
η _d	Differential Efficiency	CW, T _c = 25°C	W/A	0.014	0.063
		CW	W/A	0.010	0.100
P _f	Optical Output Power, CW	mW	–	0.6	–
I _{MOD}	Modulation Current	CW, P _f = 0.6 mW, T _c = 25°C	mA	8	45
		CW, P _f = 0.6 mW	mA	5	60
λ _c	Center Wavelength, CW, P _f = 0.6 mW, RMS (-20 dB)	nm	1270	–	1355
σ	Spectral Width, CW, P _f = 0.6 mW, RMS (-20 dB)	nm	–	–	4.0
t _r	Rise Time, I _B = I _{TH} , 10 to 90%	ns	–	–	0.3
t _f	Fall Time, I _B = I _{TH} , 90 to 10%	ns	–	–	0.3
I _m	Monitor Current, CW, P _f = 0.3 mW, V _R = 1.5 V	μA	200	–	1200
I _D	Monitor Dark Current	V _R = 1.5 V, T _c = 25 °C	nA	–	50
		V _R = 1.5 V	nA	–	500
γ	Tracking Error, CW, I _m = const. (P _f = 0.6 mW)	dB	-1.5	–	1.5
	Connector Repeatability, master pigtail	dB	-1.0	–	1.0

Note:

1. Tracking Error : γ

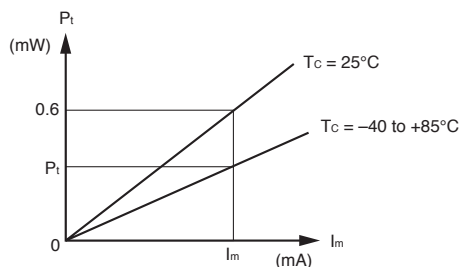

$$\gamma = \left| 10 \log \frac{P_t}{0.6} \right| \text{ [dB]}$$

ABSOLUTE MAXIMUM RATINGS¹

(T_C = 25°C, unless otherwise specified)

SYMBOLS	PARAMETERS	UNITS	RATINGS
P _F	Optical Output Power	mW	2.0
I _F	Forward Current of LD	mA	150
V _R	Reverse Voltage of LD	V	2.0
I _F	Forward Current of PD	mA	10
V _R	Reverse Voltage of PD	V	20
T _C	Operating Case Temperature	°C	-40 to +85
T _{STG}	Storage Temperature	°C	-40 to +85
T _{SLD}	Lead Soldering Temperature (10 s)	°C	350 (3 sec.)
RH	Relative Humidity (noncondensing)	%	85

Note:

1. Operation in excess of any one of these parameters may result in permanent damage.

TYPICAL PERFORMANCE CURVES (T_C = 25°C)

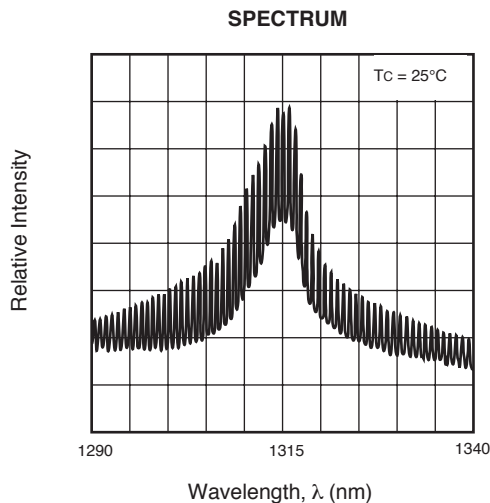
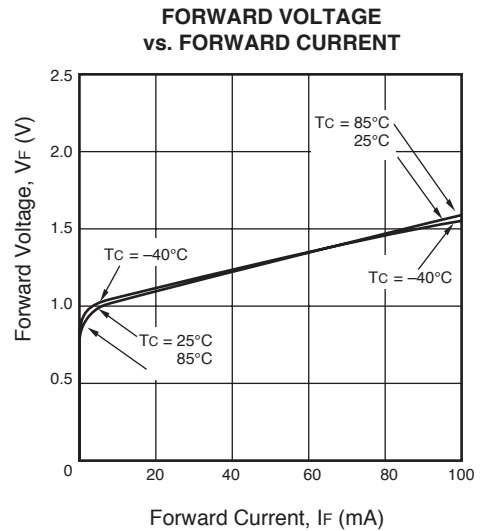
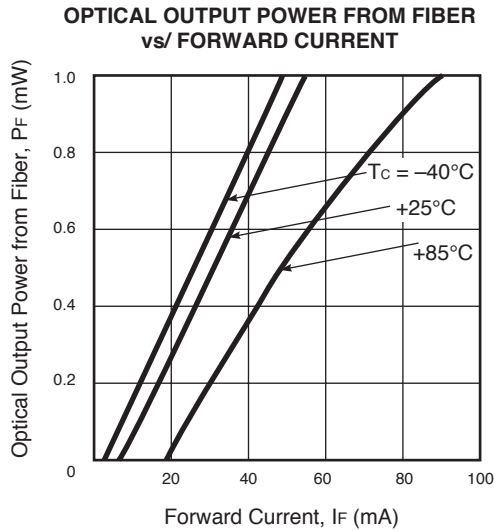

Remark: The graphs indicate nominal characteristics.

OUTLINE DIMENSIONS (Units in mm)

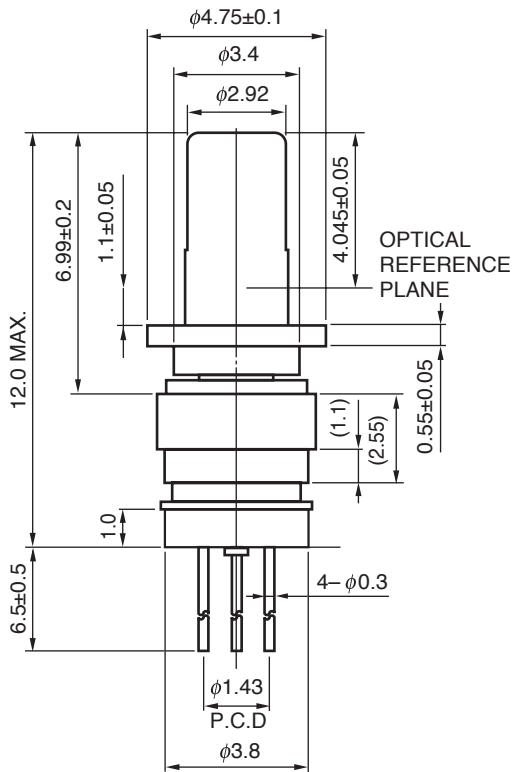

BOTTOM VIEW

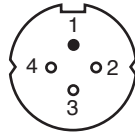

PIN CONNECTIONS

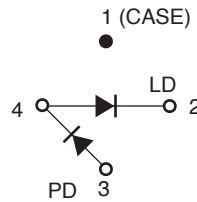

ORDERING INFORMATION

PART NUMBER	PACKAGE	PIN CONNECTION
NX7313UA-AZ*	Ø3.8 mm TOSA	

***NOTE:**

Please refer to the last page of this data sheet, "Compliance with EU Directives" for Pb-Free RoHS Compliance Information.

Life Support Applications

These NEC products are not intended for use in life support devices, appliances, or systems where the malfunction of these products can reasonably be expected to result in personal injury. The customers of CEL using or selling these products for use in such applications do so at their own risk and agree to fully indemnify CEL for all damages resulting from such improper use or sale.

CEL California Eastern Laboratories, Your source for NEC RF, Microwave, Optoelectronic, and Fiber Optic Semiconductor Devices.
 4590 Patrick Henry Drive • Santa Clara, CA 95054-1817 • (408) 988-3500 • FAX (408) 988-0279 • www.cel.com

DATA SUBJECT TO CHANGE WITHOUT NOTICE

02/27/2003

Subject: Compliance with EU Directives

CEL certifies, to its knowledge, that semiconductor and laser products detailed below are compliant with the requirements of European Union (EU) Directive 2002/95/EC Restriction on Use of Hazardous Substances in electrical and electronic equipment (RoHS) and the requirements of EU Directive 2003/11/EC Restriction on Penta and Octa BDE.

CEL Pb-free products have the same base part number with a suffix added. The suffix –A indicates that the device is Pb-free. The –AZ suffix is used to designate devices containing Pb which are exempted from the requirement of RoHS directive (*). In all cases the devices have Pb-free terminals. All devices with these suffixes meet the requirements of the RoHS directive.

This status is based on CEL’s understanding of the EU Directives and knowledge of the materials that go into its products as of the date of disclosure of this information.

Restricted Substance per RoHS	Concentration Limit per RoHS (values are not yet fixed)	Concentration contained in CEL devices	
		-A	-AZ
Lead (Pb)	< 1000 PPM	Not Detected	(*)
Mercury	< 1000 PPM	Not Detected	
Cadmium	< 100 PPM	Not Detected	
Hexavalent Chromium	< 1000 PPM	Not Detected	
PBB	< 1000 PPM	Not Detected	
PBDE	< 1000 PPM	Not Detected	

If you should have any additional questions regarding our devices and compliance to environmental standards, please do not hesitate to contact your local representative.

Important Information and Disclaimer: Information provided by CEL on its website or in other communications concerning the substance content of its products represents knowledge and belief as of the date that it is provided. CEL bases its knowledge and belief on information provided by third parties and makes no representation or warranty as to the accuracy of such information. Efforts are underway to better integrate information from third parties. CEL has taken and continues to take reasonable steps to provide representative and accurate information but may not have conducted destructive testing or chemical analysis on incoming materials and chemicals. CEL and CEL suppliers consider certain information to be proprietary, and thus CAS numbers and other limited information may not be available for release.

In no event shall CEL’s liability arising out of such information exceed the total purchase price of the CEL part(s) at issue sold by CEL to customer on an annual basis.

See CEL Terms and Conditions for additional clarification of warranties and liability.