

CEL

NEC's 1310 nm InGaAsP MQW DFB LASER DIODE IN COAXIAL PACKAGE FOR 2.5 Gb/s APPLICATION

NX8300BE-CC
NX8300CE-CC

FEATURES

- **INTERNAL OPTICAL ISOLATOR**
- **HIGH-SPEED RESPONSE:**
 $t_r = 40$ ps, $t_f = 100$ ps
- **PEAK EMISSION WAVELENGTH:**
 $\lambda_p = 1310$ nm
- **OPTICAL OUTPUT POWER:**
 $P_f = 2.0$ mW
- **WIDE OPERATING TEMPERATURE RANGE:**
 $T_c = 0$ to $+75^\circ\text{C}$
- **InGaAs MONITOR PIN-PD**
- **WITH SC-UPC CONNECTOR**
- **BASED ON TELCORDIA RELIABILITY**

DESCRIPTION

NEC's NX8300BE-CC and NX8300CE-CC are 1310 nm Distributed Feed-Back (DFB) laser diode coaxial modules with an internal optical isolator. These modules are ideal as a light source for Synchronous Digital Hierarchy (SDH) systems, STM-16, short-haul S-16.1 and long-haul L-16.1 ITU-T recommendations.

ELECTRO-OPTICAL CHARACTERISTICS ($T_c = 0$ to $+75^\circ\text{C}$, unless otherwise specified)

PART NUMBER			NX8300BE-CC, NX8300CE-CC		
SYMBOLS	PARAMETERS AND CONDITIONS	UNITS	MIN	TYP	MAX
P_f	Optical Output Power from Fiber, CW	mW		2.0	
V_{OP}	Operating Voltage, $P_f = 2.0$ mW	V		1.2	1.6
I_{TH}	Threshold Current	$T_c = +25^\circ\text{C}$		15	25
					45
P_{TH}	Threshold Output Power, $I_f = I_{TH}$	μW			50
I_{MOD}	Modulation Current	$P_f = 2.0$ mW, $T_c = 25^\circ\text{C}$	11	20	35
		$P_f = 2.0$ mW	10		40
η_d	Differential Efficiency	$P_f = 2.0$ mW, $T_c = 25^\circ\text{C}$	0.060	0.100	0.150
		$P_f = 2.0$ mW	0.050		0.200
$\Delta\eta_d$	Temperature Dependence of Differential Efficiency, $\Delta\eta_d = 10 \log \frac{\eta_d (@ T_c \text{ } ^\circ\text{C})}{\eta_d (@ 25 \text{ } ^\circ\text{C})}$	dB	-3	-1.6	
Kink	Kink, $P_f = \text{Up to } 2.4$ mW (Refer to definitions)	%			± 20
λ_p	Peak Emission Wavelength, $P_f = 2.0$ mW	nm	1285	1310	1330
$\Delta\lambda/\Delta T$	Temperature Dependence of Peak Emission Wavelength	nm/ $^\circ\text{C}$		0.09	0.1
$\Delta\lambda$	Spectral Width, $P_f = 2.0$ mW, -20 dB down width	nm		0.1	1.0
SMSR	Side Mode Suppression Ratio, $P_f = 2.0$ mW	dB	30	40	
f_r	Relaxation Oscillation Frequency, $P_f = 2.0$ mW	GHz		8.0	
t_r	Rise Time, 10 to 90%, $P_{pk} = 2.0$ mW, $I_f = I_{TH}$	ps		40	125
t_f	Fall Time, 90 to 10%, $P_{pk} = 2.0$ mW, $I_f = I_{TH}$	ps		100	200
I_m	Monitor Current, $V_R = 5$ V, $P_f = 2.0$ mW	μA	100	500	1000
I_D	Monitor Dark Current	$V_R = 5$ V, $T_c = 25^\circ\text{C}$		0.1	50
		$V_R = 5$ V		10	500
C_t	Monitor PD Terminal Capacitance, $V_R = 5$ V, $f = 1$ MHz	pF		1.0	20
LIN_m	Linearity, $V_R = 5$ V, $P_f = 0.2$ to 2.0 mW (Refer to definitions)	%			10
γ^1	Tracking Error, $I_m = \text{const.}$ (Refer to definitions)	dB		0.5	1.0

ABSOLUTE MAXIMUM RATINGS¹

(T_c = 25°C, unless otherwise specified)

SYMBOLS	PARAMETERS	UNITS	RATINGS
P _f	Optical Output Power from Fiber	mW	5
I _F	Forward Current of LD	mA	150
V _R	Reverse Voltage of LD	V	2.0
I _F	Forward Current of PD	mA	2.0
V _R	Reverse Voltage of PD	V	15
T _c	Operating Case Temperature	°C	0 to +75
T _{STG}	Storage Temperature	°C	-40 to +85
T _{SLD}	Lead Soldering Temperature (10 s)	°C	260
RH	Relative Humidity (noncondensing)	%	85

Note:

1. Operation in excess of any one of these parameters may result in permanent damage.

PARAMETER DEFINITIONS

Kink : kink

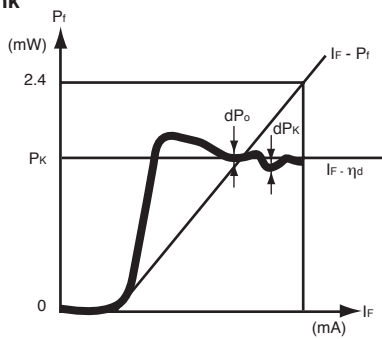

$$\text{kink} = \frac{|dPk|}{P_K} \times 100 \text{ [%]}$$

dPk = dPo MAX
 P_K ≤ 2.4 (mW)

Linearity : LINm

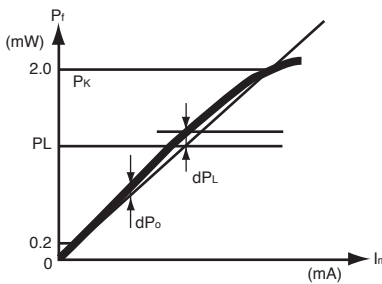

$$\text{LINm} = \frac{|dPL|}{P_L} \times 100 \text{ [%]}$$

dPL = dPo MAX
 0.2 < P_L < 2.0 (mW)

Tracking Error : γ

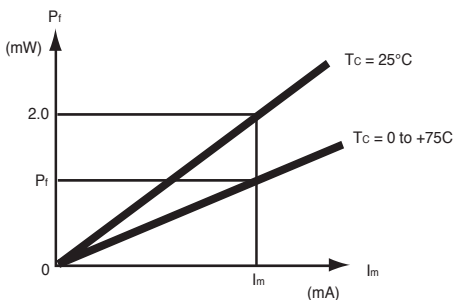

$$\gamma = 10 \log \frac{P_f}{2.0} \text{ [dB]}$$

TYPICAL PERFORMANCE CURVES ($T_c = 25^\circ\text{C}$ unless otherwise specified)

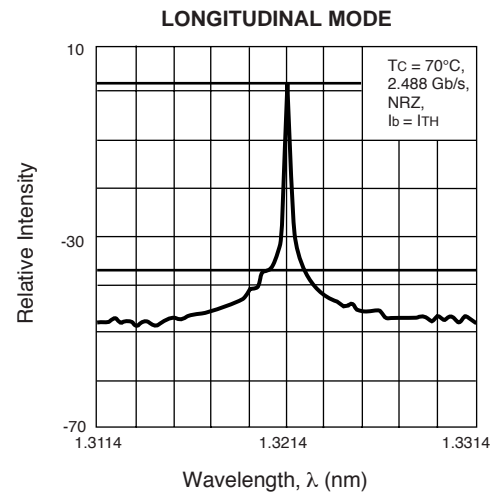
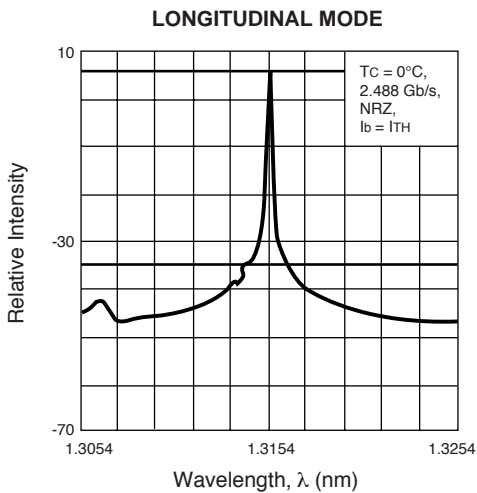
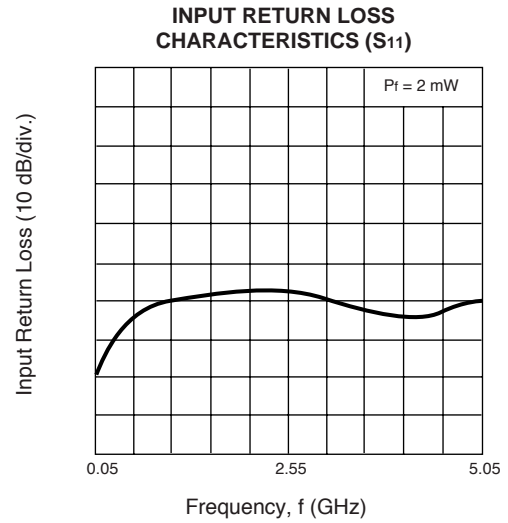
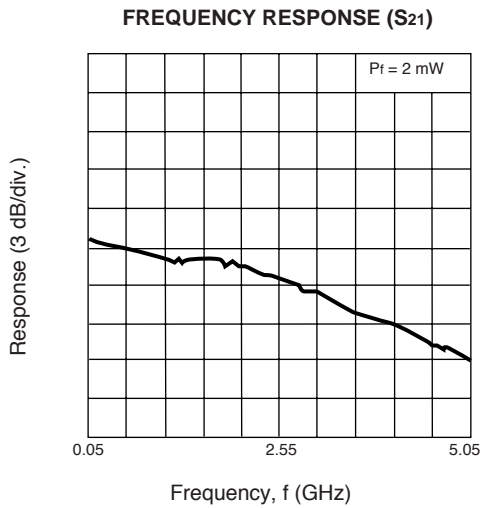
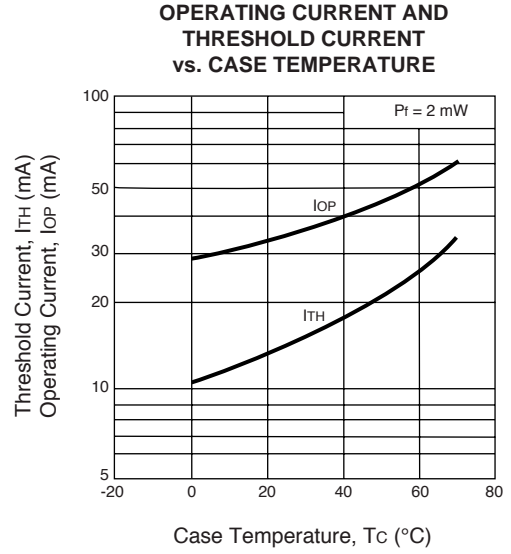
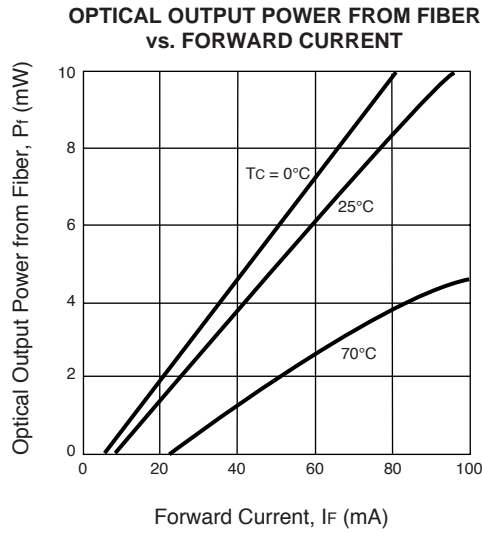

TYPICAL PERFORMANCE CURVES ($T_c = 25^\circ\text{C}$ unless otherwise specified)

EYE DIAGRAM

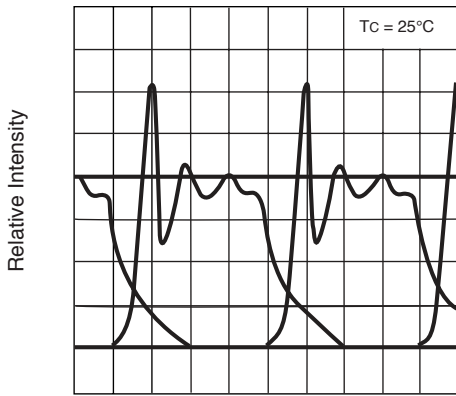

Time Base (100 ps/div.)

EYE DIAGRAM

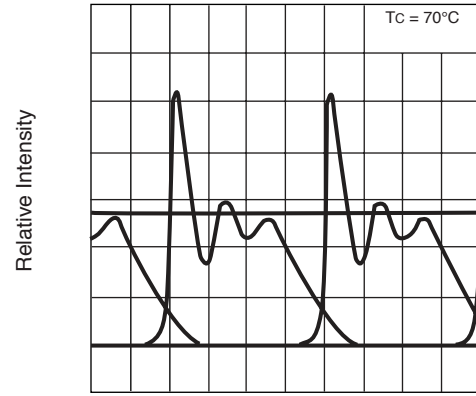

Time Base (100 ps/div.)

ERROR RATE CHARACTERISTICS

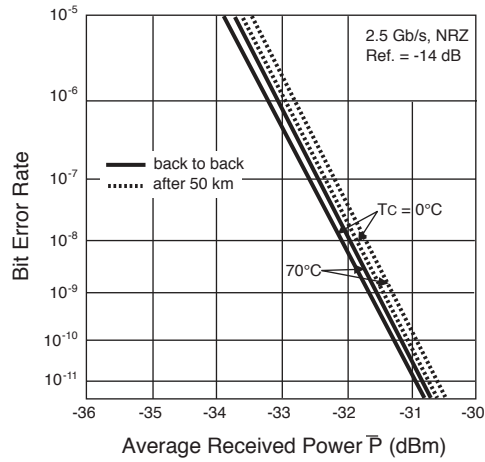

Remark: The graphs indicate nominal characteristics.

OUTLINE DIMENSIONS (Units in mm)

NX8300BE-CC

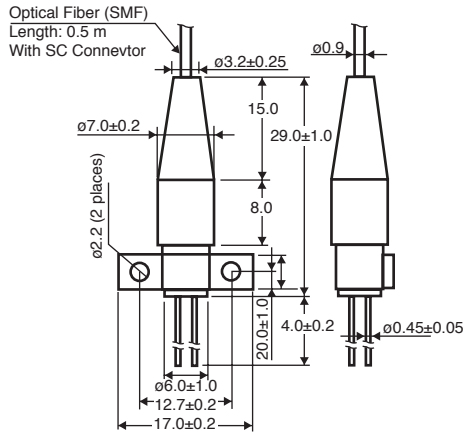

NX8300CE-CC

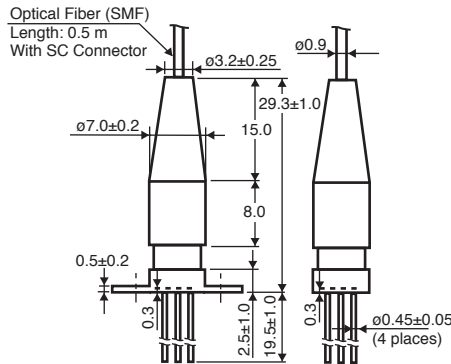

PIN CONNECTIONS

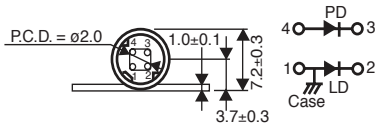

PIN CONNECTIONS

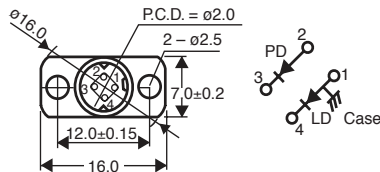

OPTICAL FIBER CHARACTERISTICS

PARAMETER	UNITS	SPECIFICATION
Mode Field Diameter	μm	9.5±1
Cladding Diameter	μm	125±2
Maximum Cladding Noncircularity	%	2
Maximum Core/Cladding Concentricity	%	1.6
Outer Diameter	mm	0.9±0.1
Cut-off Wavelength	nm	1100 to 1270
Minimum Fiber Bending Radius	mm	30
Fiber Length	mm	500±50
Flammability		UL 1581 VW-1

ORDERING INFORMATION

PART NUMBER	AVAILABLE CONNECTOR	FLANGE TYPE
NX8300BE-CC	With SC-UPC Connector	Flat Mount Flange
NX8300CE-CC		Vertical Mount Flange

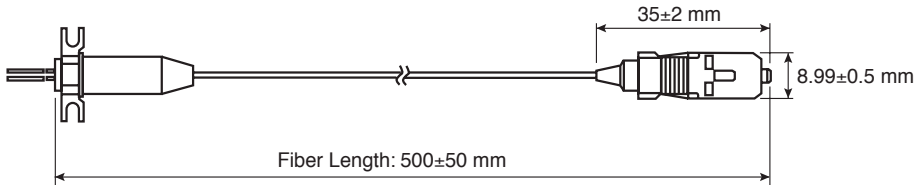

Life Support Applications

These NEC products are not intended for use in life support devices, appliances, or systems where the malfunction of these products can reasonably be expected to result in personal injury. The customers of CEL using or selling these products for use in such applications do so at their own risk and agree to fully indemnify CEL for all damages resulting from such improper use or sale.

CEL California Eastern Laboratories, Your source for NEC RF, Microwave, Optoelectronic, and Fiber Optic Semiconductor Devices.

4590 Patrick Henry Drive • Santa Clara, CA 95054-1817 • (408) 988-3500 • FAX (408) 988-0279 • www.cel.com

DATA SUBJECT TO CHANGE WITHOUT NOTICE

03/03/2003