



NEC's 1310 nm InGaAsP MQW DFB LASER DIODE IN COAXIAL PACKAGE FOR 622 Mb/s APPLICATION

NX8303BG-CC
NX8303CG-CC

FEATURES

- **PEAK EMISSION WAVELENGTH:**
 $\lambda_p = 1310 \text{ nm}$
- **OPTICAL OUTPUT POWER:**
 $P_f = 2.0 \text{ mW}$
- **WIDE OPERATING TEMPERATURE RANGE:**
 $T_c = -10 \text{ to } +85^\circ\text{C}$
- **SIDE MODE SUPPRESSION RATIO**
 $\text{SMSR} = 40 \text{ dB}$
- **InGaAs MONITOR PIN-PD**
- **WITH SC-UPC CONNECTOR**
- **BASED ON TELCORDIA RELIABILITY**

DESCRIPTION

NEC's NX8303BG-CC and NX8303CG-CC are 1310 nm Distributed Feed-Back (DFB) laser diode coaxial modules with an internal optical isolator. These modules are ideal as light sources for Synchronous Digital Hierarchy (SDH) systems, STM-4, long-haul L-4.1 ITU-T recommendations.

ELECTRO-OPTICAL CHARACTERISTICS ($T_c = -10 \text{ to } +85^\circ\text{C}$, unless otherwise specified)

PART NUMBER			NX8303BG-CC, NX8303CG-CC		
SYMBOLS	PARAMETERS AND CONDITIONS	UNITS	MIN	TYP	MAX
P_f	Optical Output Power from Fiber, CW	mW		2.0	
VOP	Operating Voltage, $P_f = 2.0 \text{ mW}$	V		1.2	1.6
I_{TH}	Threshold Current	$T_c = +25^\circ\text{C}$		15	25
					55
P_{TH}	Threshold Output Power, $I_f = I_{TH}$	μW			100
I_{MOD}	Modulation Current	$P_f = 2.0 \text{ mW}$, $T_c = 25^\circ\text{C}$	8	20	30
		$P_f = 2.0 \text{ mW}$	6		50
η_d	Differential Efficiency	$P_f = 2.0 \text{ mW}$, $T_c = 25^\circ\text{C}$	0.070	0.100	0.200
		$P_f = 2.0 \text{ mW}$	0.040		0.300
$\Delta\eta_d$	Temperature Dependence of Differential Efficiency, $\Delta\eta_d = 10 \log \frac{\eta_d (@ T_c \text{ } ^\circ\text{C})}{\eta_d (@ 25 \text{ } ^\circ\text{C})}$	dB	-3.5	-2.2	
Kink	Kink, $P_f = \text{Up to } 2.4 \text{ mW}$ (Refer to definitions)	%			± 20
λ_p	Peak Emission Wavelength, $P_f = 2.0 \text{ mW}$	nm	1280	1310	1335
$\Delta\lambda/\Delta T$	Temperature Dependence of Peak Emission Wavelength	nm/ $^\circ\text{C}$		0.09	0.1
$\Delta\lambda$	Spectral Width, $P_f = 2.0 \text{ mW}$, -20 dB down width	nm		0.1	1.0
SMSR	Side Mode Suppression Ratio, $P_f = 2.0 \text{ mW}$	dB	30	40	
f_c	Cut-off Frequency, -3 dB, $V_R = 5 \text{ V}$, $P_f = 2.0 \text{ mW}$	GHz		2.0	
t_r	Rise Time, 10 to 90%, $P_{pk} = 2.0 \text{ mW}$, $I_f = I_{TH}$	ns		0.15	0.5
t_f	Fall Time, 90 to 10%, $P_{pk} = 2.0 \text{ mW}$, $I_f = I_{TH}$	ns		0.15	0.5
I_m	Monitor Current, $V_R = 5 \text{ V}$, $P_f = 2.0 \text{ mW}$	μA	200	700	1500
I_D	Monitor Dark Current	$V_R = 5 \text{ V}$, $T_c = 25^\circ\text{C}$		0.1	50
		$V_R = 5 \text{ V}$		10	500
C_t	Monitor PD Terminal Capacitance, $V_R = 5 \text{ V}$, $f = 1 \text{ MHz}$	pF		1.0	20
LIN _m	Linearity, $V_R = 5 \text{ V}$, $P_f = 0.2 \text{ to } 2.0 \text{ mW}$ (Refer to definitions)	%			10
γ^1	Tracking Error, $I_m = \text{const.}$ (Refer to definitions)	dB		0.5	1.0
RIN	Relative Intensity Noise, Ref = -14 dB	dB/Hz		-135	

ABSOLUTE MAXIMUM RATINGS¹

(T_c = 25°C, unless otherwise specified)

SYMBOLS	PARAMETERS	UNITS	RATINGS
P _f	Optical Output Power from Fiber	mW	5
I _F	Forward Current of LD	mA	150
V _R	Reverse Voltage of LD	V	2.0
I _F	Forward Current of PD	mA	2.0
V _R	Reverse Voltage of PD	V	15
T _c	Operating Case Temperature	°C	-10 to +85
T _{STG}	Storage Temperature	°C	-40 to +85
T _{SLD}	Lead Soldering Temperature (10 s)	°C	260
RH	Relative Humidity (noncondensing)	%	85

Note:

1. Operation in excess of any one of these parameters may result in permanent damage.

PARAMETER DEFINITIONS

Kink : kink

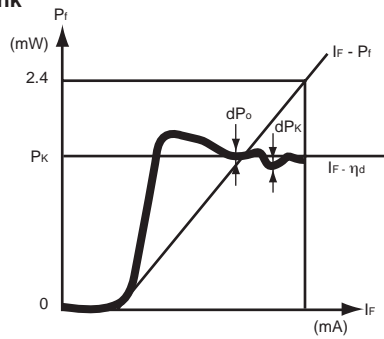

$$\text{kink} = \frac{|dP_k|}{P_k} \times 100 \text{ [%]}$$

dP_k = dP_o MAX
 P_k ≤ 2.4 (mW)

Linearity : LINm

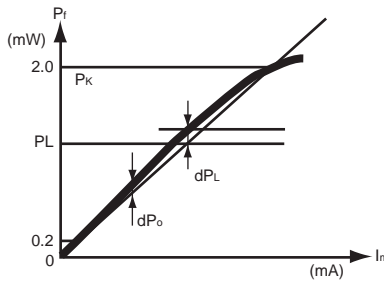

$$\text{LINm} = \frac{|dP_L|}{P_L} \times 100 \text{ [%]}$$

dP_L = dP_o MAX
 0.2 < P_L < 2.0 (mW)

Tracking Error : γ

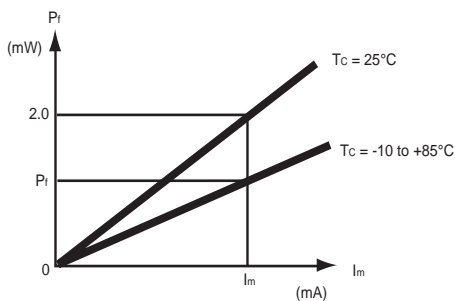

$$\gamma = \left| 10 \log \frac{P_f}{2.0} \right| \text{ [dB]}$$

TYPICAL PERFORMANCE CURVES ($T_c = 25^\circ\text{C}$ unless otherwise specified)

OPERATING CURRENT AND THRESHOLD CURRENT vs. CASE TEMPERATURE

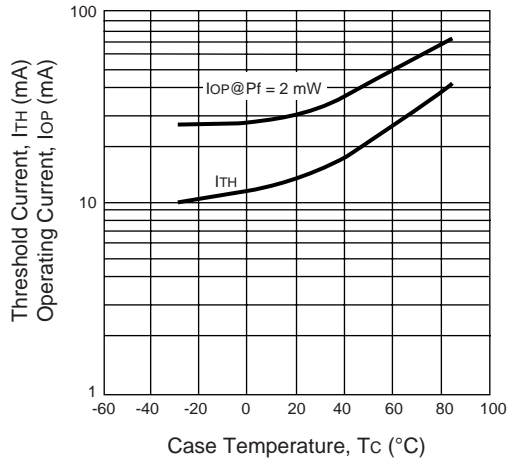

TEMPERATURE DEPENDENCE OF PEAK EMISSION WAVELENGTH

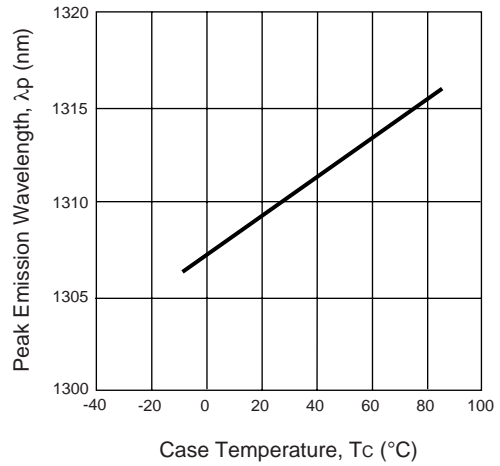

TEMPERATURE DEPENDENCE OF DIFFERENTIAL EFFICIENCY FROM FIBER

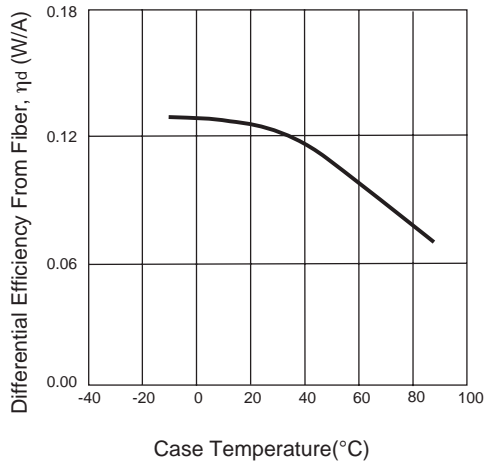

FORWARD CURRENT vs. FORWARD VOLTAGE

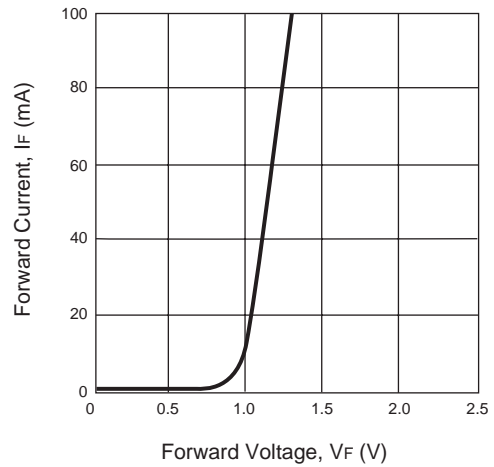

SPECTRUM

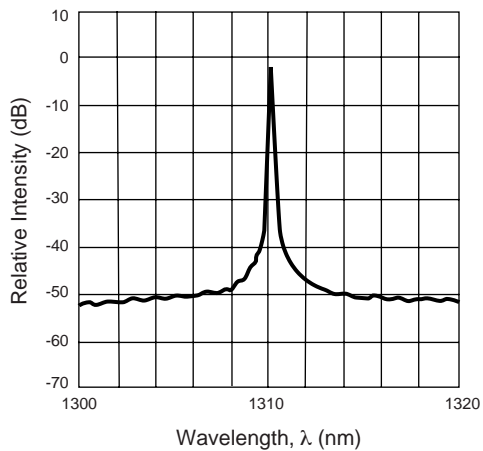

Remark: The graphs indicate nominal characteristics.

OUTLINE DIMENSIONS (Units in mm)

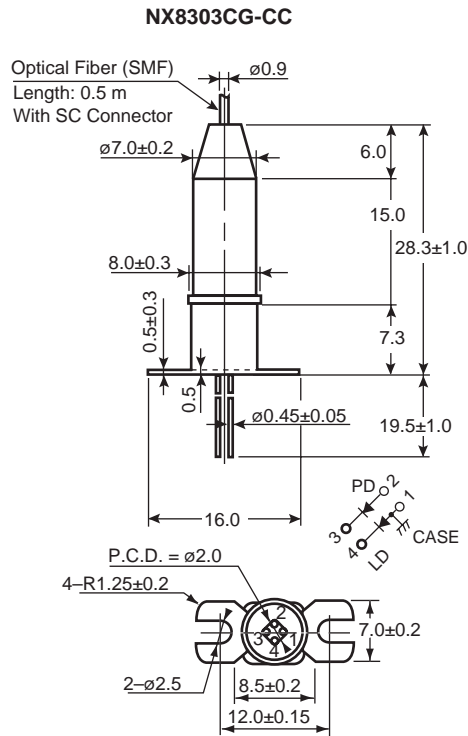
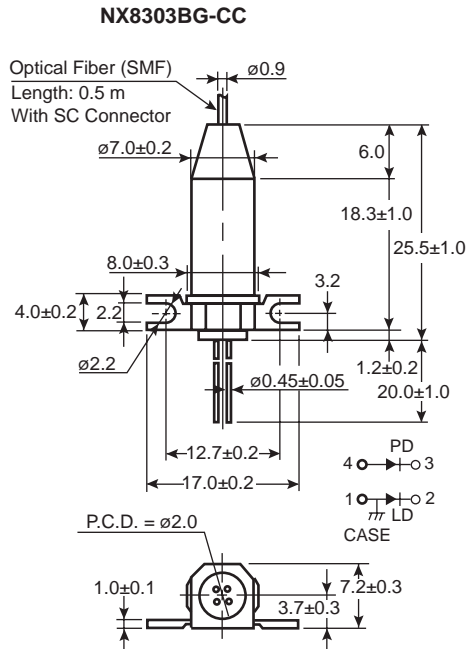

ORDERING INFORMATION

PART NUMBER	AVAILABLE CONNECTOR	FLANGE TYPE
NX8303BG-CC	With SC-UPC Connector	Flat Mount Flange
NX8303CG-CC		Vertical Mount Flange

OPTICAL FIBER CHARACTERISTICS

PARAMETER	UNITS	SPECIFICATION
Mode Field Diameter	μm	9.5±1
Cladding Diameter	μm	125±2
Maximum Cladding Noncircularity	%	2
Maximum Core/Cladding Concentricity	%	1.6
Outer Diameter	mm	0.9±0.1
Cut-off Wavelength	nm	1100 to 1270
Minimum Fiber Bending Radius	mm	30
Fiber Length	mm	500±50
Flammability		UL 1581 VW-1

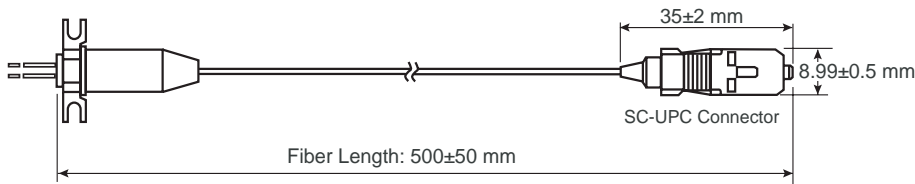

Life Support Applications

These NEC products are not intended for use in life support devices, appliances, or systems where the malfunction of these products can reasonably be expected to result in personal injury. The customers of CEL using or selling these products for use in such applications do so at their own risk and agree to fully indemnify CEL for all damages resulting from such improper use or sale.

CEL California Eastern Laboratories, Your source for NEC RF, Microwave, Optoelectronic, and Fiber Optic Semiconductor Devices.
 4590 Patrick Henry Drive • Santa Clara, CA 95054-1817 • (408) 988-3500 • FAX (408) 988-0279 • www.cel.com

DATA SUBJECT TO CHANGE WITHOUT NOTICE

03/03/2003