

Silicon Carbide (SiC) Module – 8 mohm SiC M3S MOSFET, 1200 V, 2-PACK Half Bridge Topology, F1 Package

Product Preview

NXH008P120M3F1PTG, NXH008P120M3F1PG

The NXH008P120M3F1 is a power module containing 8 mΩ / 1200 V SiC MOSFET half-bridge and a thermistor in an F1 package.

Features

- 8 mΩ / 1200 V M3S SiC MOSFET Half-Bridge
- Thermistor
- Options with Pre-Applied Thermal Interface Material (TIM) and without Pre-Applied TIM
- Press-Fit Pins
- These Devices are Pb-Free, Halide Free and are RoHS Compliant

Typical Applications

- Solar Inverter
- Uninterruptible Power Supplies
- Electric Vehicle Charging Stations
- Industrial Power

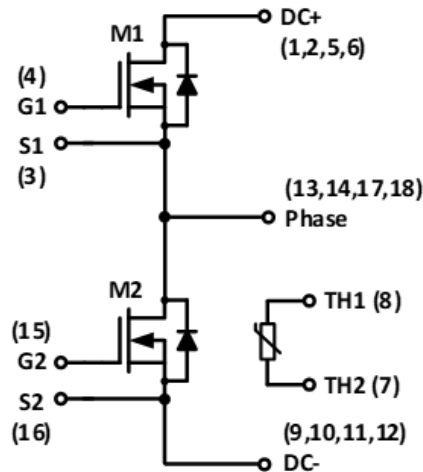
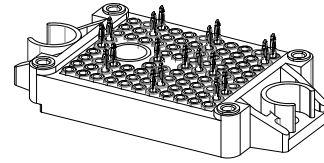

Figure 1. NXH008P120M3F1 Schematic Diagram

This document contains information on a product under development. onsemi reserves the right to change or discontinue this product without notice.

PACKAGE PICTURE



PIM18 33.8x42.5 (PRESS FIT)
CASE 180BW

MARKING DIAGRAM

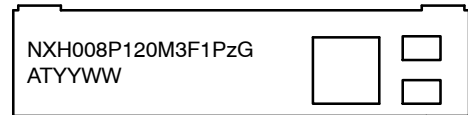

NXH008P120M3F1PzG = Specific Device Code
z = T (with TIM), blank (without TIM)
AT = Assembly & Test Site Code
YYWW = Year and Work Week Code

PIN CONNECTIONS

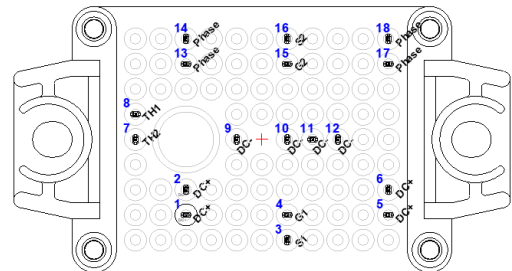

See Pin Function Description for pin names

ORDERING INFORMATION

See detailed ordering and shipping information on page 4 of this data sheet.

NXH008P120M3F1PTG, NXH008P120M3F1PG

PIN FUNCTION DESCRIPTION

| Pin | Name | Description |
|-----|-------|-------------------------------------|
| 1 | DC+ | DC Positive Bus connection |
| 2 | DC+ | DC Positive Bus connection |
| 3 | S1 | M1 Kelvin Source (High side switch) |
| 4 | G1 | M1 Gate (High side switch) |
| 5 | DC+ | DC Positive Bus connection |
| 6 | DC+ | DC Positive Bus connection |
| 7 | TH2 | Thermistor Connection 2 |
| 8 | TH1 | Thermistor Connection 1 |
| 9 | DC- | DC Negative Bus connection |
| 10 | DC- | DC Negative Bus connection |
| 11 | DC- | DC Negative Bus connection |
| 12 | DC- | DC Negative Bus connection |
| 13 | PHASE | Center point of half bridge |
| 14 | PHASE | Center point of half bridge |
| 15 | G2 | M2 Gate (Low side switch) |
| 16 | S2 | M2 Kelvin Source (Low side switch) |
| 17 | PHASE | Center point of half bridge |
| 18 | PHASE | Center point of half bridge |

NXH008P120M3F1PTG, NXH008P120M3F1PG

MAXIMUM RATINGS

| Rating | Symbol | Value | Unit |
|---|--------------|---------|------------------|
| SiC MOSFET | | | |
| Drain–Source Voltage | V_{DSS} | 1200 | V |
| Gate–Source Voltage | V_{GS} | +22/-10 | V |
| Continuous Drain Current @ $T_C = 80^\circ\text{C}$ ($T_J = 175^\circ\text{C}$) | I_D | 145 | A |
| Pulsed Drain Current ($T_J = 150^\circ\text{C}$) | I_{Dpulse} | 436 | A |
| Maximum Power Dissipation ($T_J = 175^\circ\text{C}$) | P_{tot} | 382 | W |
| Minimum Operating Junction Temperature | T_{JMIN} | -40 | $^\circ\text{C}$ |
| Maximum Operating Junction Temperature | T_{JMAX} | 175 | $^\circ\text{C}$ |

THERMAL PROPERTIES

| | | | |
|---------------------------|-----------|------------|------------------|
| Storage Temperature Range | T_{stg} | -40 to 150 | $^\circ\text{C}$ |
|---------------------------|-----------|------------|------------------|

INSULATION PROPERTIES

| | | | |
|--|----------|-------------------------|-----------|
| Isolation Test Voltage, $t = 1$ s, 60 Hz | V_{is} | 4800 | V_{RMS} |
| Creepage Distance | | 12.7 | mm |
| CTI | | 600 | |
| Substrate Ceramic Material | | Al_2O_3 | |
| Substrate Ceramic Material Thickness | | 0.32 | mm |

Stresses exceeding those listed in the Maximum Ratings table may damage the device. If any of these limits are exceeded, device functionality should not be assumed, damage may occur and reliability may be affected.

1. Refer to ELECTRICAL CHARACTERISTICS, RECOMMENDED OPERATING RANGES and/or APPLICATION INFORMATION for Safe Operating parameters.

RECOMMENDED OPERATING RANGES

| Rating | Symbol | Min | Max | Unit |
|---------------------------------------|--------|-----|-----|------------------|
| Module Operating Junction Temperature | T_J | -40 | 150 | $^\circ\text{C}$ |

Functional operation above the stresses listed in the Recommended Operating Ranges is not implied. Extended exposure to stresses beyond the Recommended Operating Ranges limits may affect device reliability.

ELECTRICAL CHARACTERISTICS ($T_J = 25^\circ\text{C}$ unless otherwise noted)

| Parameter | Test Conditions | Symbol | Min | Typ | Max | Unit |
|-----------------------------------|---|----------------|------|------|------|---------------|
| SiC MOSFET CHARACTERISTICS | | | | | | |
| Zero Gate Voltage Drain Current | $V_{GS} = 0$ V, $V_{DS} = 1200$ V, $T_J = 25^\circ\text{C}$ | I_{DSS} | – | – | 400 | μA |
| Drain–Source On Resistance | $V_{GS} = 18$ V, $I_D = 120$ A, $T_J = 25^\circ\text{C}$ | $R_{DS(ON)}$ | – | 7.7 | 10.9 | m Ω |
| | $V_{GS} = 18$ V, $I_D = 120$ A, $T_J = 125^\circ\text{C}$ | | – | 12.6 | – | |
| | $V_{GS} = 18$ V, $I_D = 120$ A, $T_J = 150^\circ\text{C}$ | | – | 14.4 | – | |
| | $V_{GS} = 18$ V, $I_D = 120$ A, $T_J = 175^\circ\text{C}$ | | – | 18.1 | – | |
| Gate–Source Threshold Voltage | $V_{GS} = V_{DS}$, $I_D = 60$ mA | $V_{GS(TH)}$ | 2.04 | 2.4 | 4.4 | V |
| Internal Gate Resistance | | R_{GINT} | – | 0.8 | – | Ω |
| Gate Leakage Current | $V_{GS} = -10$ V / 22 V, $V_{DS} = 0$ V | I_{GSS} | -4 | – | 4 | μA |
| Input Capacitance | $V_{DS} = 800$ V, $V_{GS} = 0$ V, $f = 1$ MHz | C_{ISS} | – | 8334 | – | pF |
| Reverse Transfer Capacitance | | C_{RSS} | – | 37 | – | |
| Output Capacitance | | C_{OSS} | – | 472 | – | |
| Total Gate Charge | $V_{DS} = 800$ V, $V_{GS} = -3/18$ V, $I_D = 120$ A | $Q_{G(TOTAL)}$ | – | 419 | – | nC |
| Gate–Source Charge | | Q_{GS} | – | 61 | – | |
| Gate–Drain Charge | | Q_{GD} | – | 96 | – | |

NXH008P120M3F1PTG, NXH008P120M3F1PG

ELECTRICAL CHARACTERISTICS (T_J = 25°C unless otherwise noted) (continued)

| Parameter | Test Conditions | Symbol | Min | Typ | Max | Unit |
|---------------------------------------|--|---------------------|-----|-------|-----|------|
| SiC MOSFET CHARACTERISTICS | | | | | | |
| Turn-on Delay Time | T _J = 25°C V _{DS} = 800 V, I _D = 120 A V _{GS} = -3 V / 18 V, R _G = 2 Ω | t _{d(on)} | – | 17 | – | ns |
| Rise Time | | t _r | – | 17 | – | |
| Turn-off Delay Time | | t _{d(off)} | – | 97 | – | |
| Fall Time | | t _f | – | 12 | – | |
| Turn-on Switching Loss per Pulse | | E _{ON} | – | 1760 | – | μJ |
| Turn-off Switching Loss per Pulse | | E _{OFF} | – | 588 | – | |
| Turn-on Delay Time | T _J = 150°C V _{DS} = 800 V, I _D = 120 A V _{GS} = -3 V / 18 V, R _G = 2 Ω | t _{d(on)} | – | 15 | – | ns |
| Rise Time | | t _r | – | 15 | – | |
| Turn-off Delay Time | | t _{d(off)} | – | 110 | – | |
| Fall Time | | t _f | – | 13 | – | |
| Turn-on Switching Loss per Pulse | | E _{ON} | – | 2155 | – | μJ |
| Turn-off Switching Loss per Pulse | | E _{OFF} | – | 745 | – | |
| Diode Forward Voltage | V _{GS} = -3 V, I _{SD} = 120 A, T _J = 25°C | V _{SD} | – | 4.67 | 6.2 | V |
| | V _{GS} = -3 V, I _{SD} = 120 A, T _J = 125°C | | – | 4.45 | – | |
| | V _{GS} = -3 V, I _{SD} = 120 A, T _J = 150°C | | – | 4.4 | – | |
| Thermal Resistance – Chip-to-Case | M1, M2 | R _{thJC} | – | 0.249 | – | °C/W |
| Thermal Resistance – Chip-to-Heatsink | Thermal grease, Thickness = 2 Mil +2%, A = 2.8 W/mK | R _{thJH} | – | 0.466 | – | °C/W |

THERMISTOR CHARACTERISTICS

| | | | | | | |
|---------------------------------------|----------------------------------|------------------|----|-------|---|------|
| Nominal Resistance | T = 25°C | R ₂₅ | – | 5 | – | kΩ |
| | T = 100°C | R ₁₀₀ | – | 493 | – | Ω |
| | T = 150°C | R ₁₅₀ | – | 159.5 | – | Ω |
| Deviation of R ₁₀₀ | T = 100°C | ΔR/R | -5 | – | 5 | % |
| Power Dissipation – Recommended Limit | 0.15 mA, Non-self-heating Effect | P _D | – | 0.1 | – | mW |
| Power Dissipation – Absolute Maximum | 5 mA | P _D | – | 34.2 | – | mW |
| Power Dissipation Constant | | | – | 1.4 | – | mW/K |
| B-value | B (25/50), tolerance ±2% | | – | 3375 | – | K |
| B-value | B (25/100), tolerance ±2% | | – | 3436 | – | K |

Product parametric performance is indicated in the Electrical Characteristics for the listed test conditions, unless otherwise noted. Product performance may not be indicated by the Electrical Characteristics if operated under different conditions.

ORDERING INFORMATION

| Orderable Part Number | Marking | Package | Shipping |
|-----------------------|-------------------|--|-------------------------|
| NXH008P120M3F1PTG | NXH008P120M3F1PTG | F1HALFBR: Case 180BW Press-fit Pins with pre-applied thermal interface material (TIM) (Pb-Free / Halide Free) | 28 Units / Blister Tray |
| NXH008P120M3F1PG | NXH008P120M3F1PG | F1HALFBR: Case 180BW Press-fit Pins (Pb-Free / Halide Free) | 28 Units / Blister Tray |

TYPICAL CHARACTERISTIC
(M1/M2 SiC MOSFET CHARACTERISTIC)

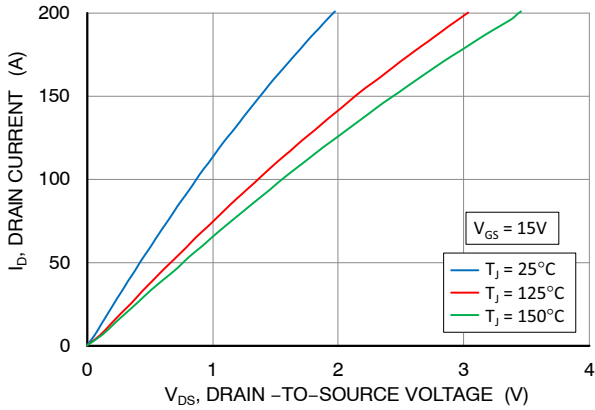

Figure 2. MOSFET Typical Output Characteristic $V_{GS} = 15\text{ V}$

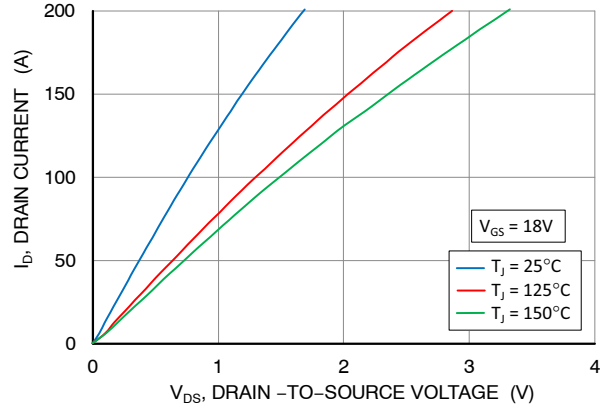

Figure 3. MOSFET Typical Output Characteristic $V_{GS} = 18\text{ V}$

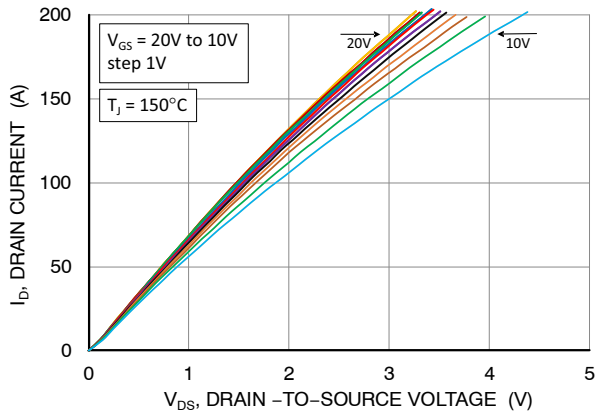

Figure 4. MOSFET Typical Output Characteristic $V_{GS} = \text{Var.}$

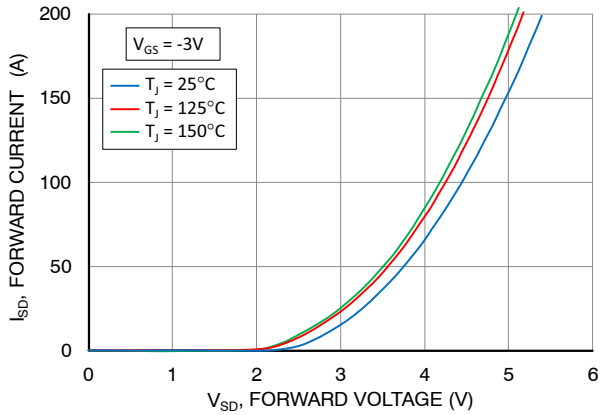

Figure 5. Body Diode Forward Characteristic

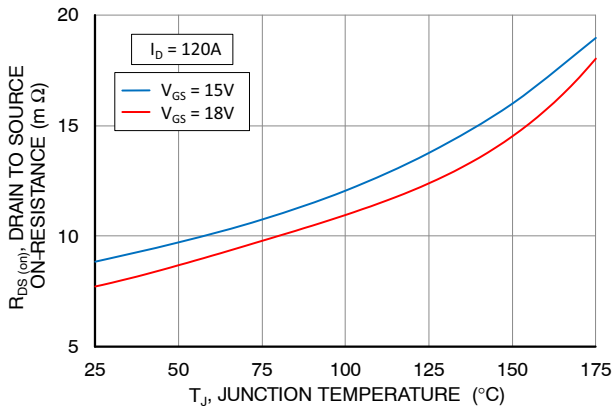

Figure 6. $R_{DS(on)}$ Drain-to-Source ON Resistance vs. Junction Temperature

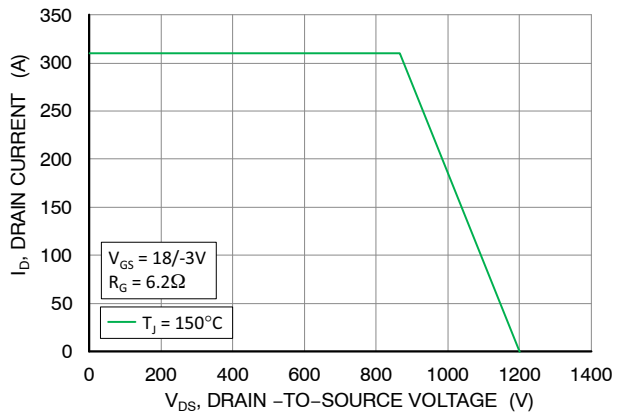

Figure 7. Reverse Bias Safe Operating Area (RBSOA)

TYPICAL CHARACTERISTICS
M1/M2 SIC MOSFET CHARACTERISTIC

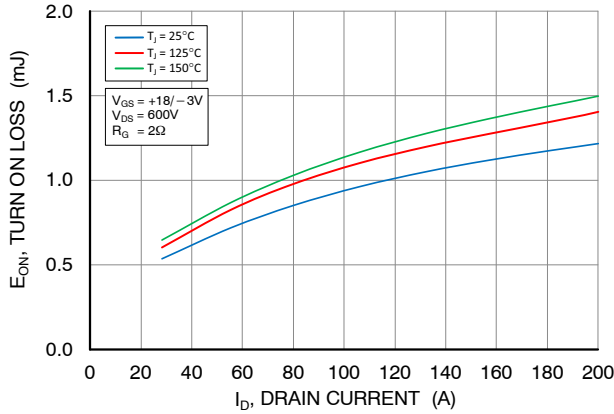

Figure 8. Switching on Loss vs. Drain Current $V_{DS} = 600\text{ V}$

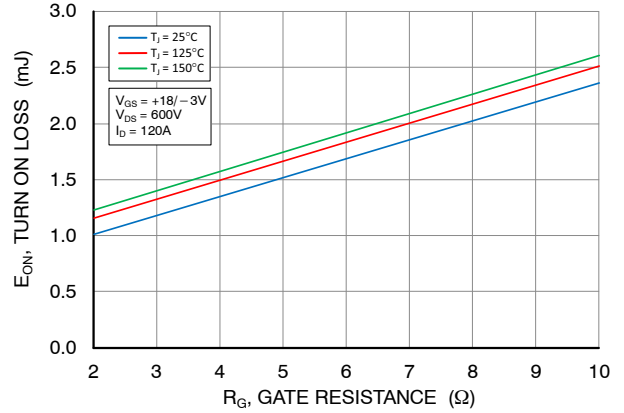

Figure 9. Switching on Loss vs. Gate Resistance $V_{DS} = 600\text{ V}$

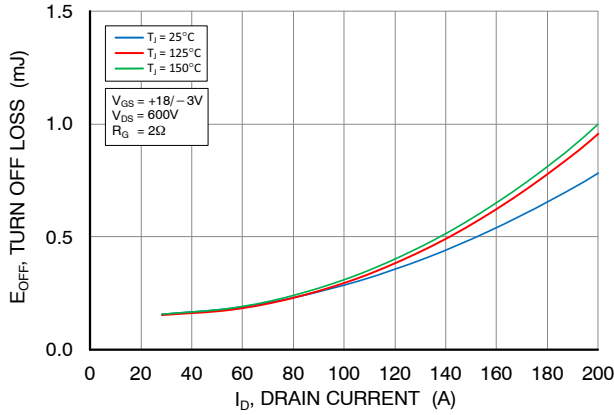

Figure 10. Switching off Loss vs. Drain Current $V_{DS} = 600\text{ V}$

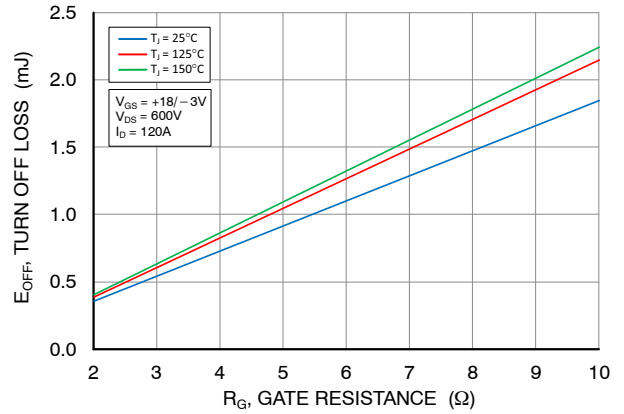

Figure 11. Switching off Loss vs. Gate Resistance $V_{DS} = 600\text{ V}$

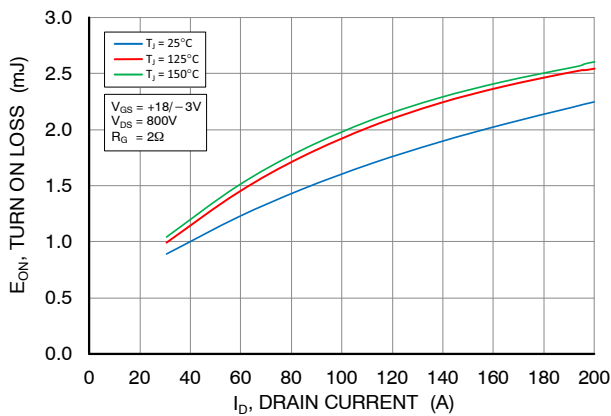

Figure 12. Switching on Loss vs. Drain Current $V_{DS} = 800\text{ V}$

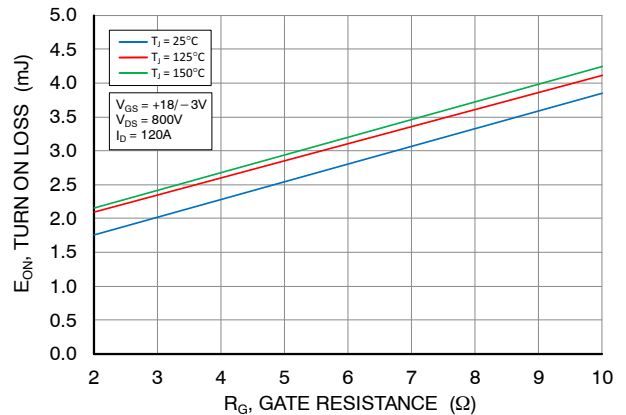

Figure 13. Switching on Loss vs. Gate Resistance $V_{DS} = 800\text{ V}$

TYPICAL CHARACTERISTICS
M1/M2 SIC MOSFET CHARACTERISTIC

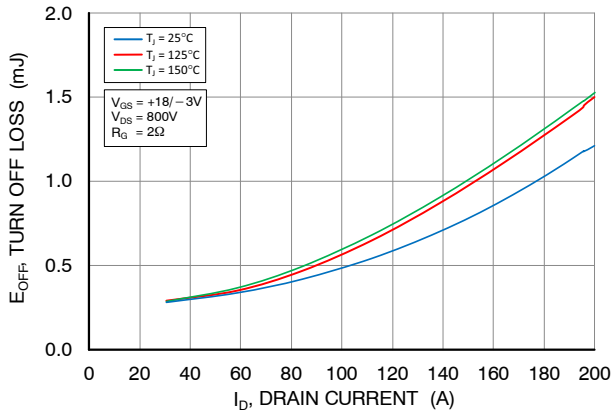

Figure 14. Switching off Loss vs. Drain Current $V_{DS} = 800\text{ V}$

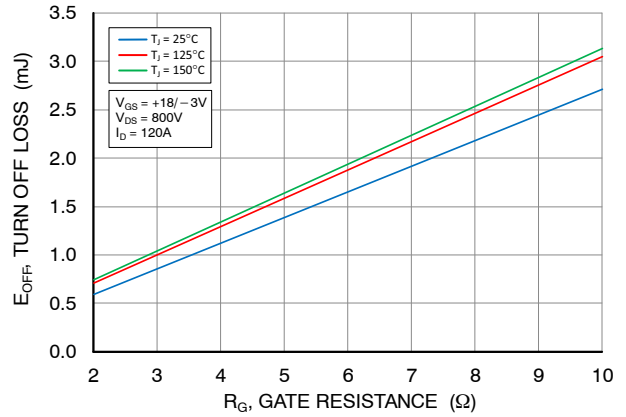

Figure 15. Switching off Loss vs. Gate Resistance $V_{DS} = 800\text{ V}$

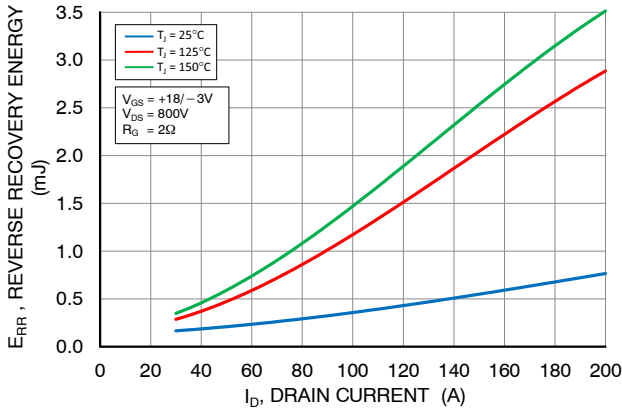

Figure 16. Reverse Recovery Energy vs. Drain Current $V_{DS} = 800\text{ V}$

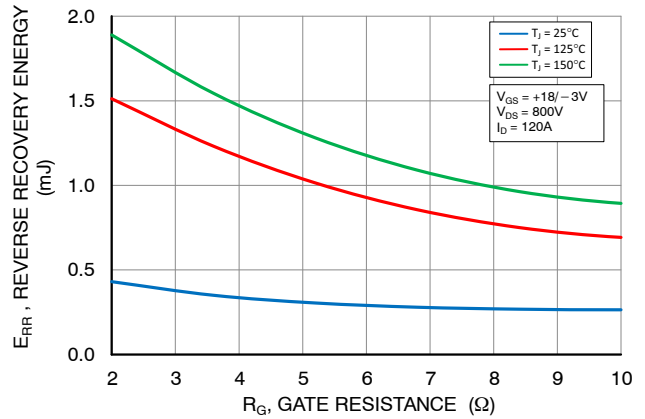

Figure 17. Reverse Recovery Energy vs. Gate Resistance $V_{DS} = 800\text{ V}$

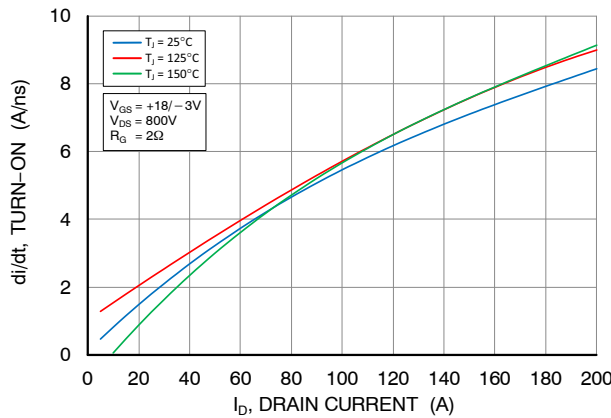

Figure 18. di/dt Turn ON vs. Drain Current $V_{DS} = 800\text{ V}$

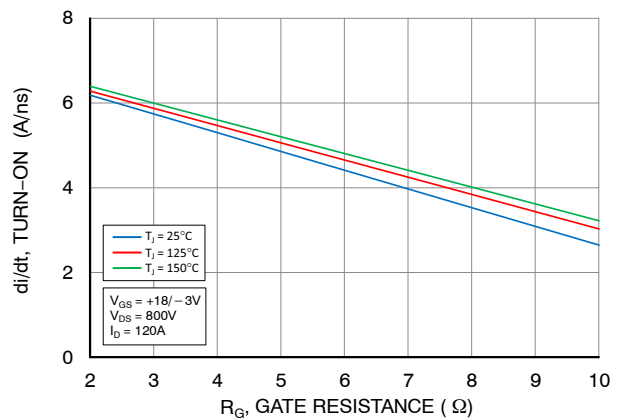

Figure 19. di/dt Turn ON vs. Gate Resistance $V_{DS} = 800\text{ V}$

TYPICAL CHARACTERISTICS
M1/M2 SIC MOSFET CHARACTERISTIC

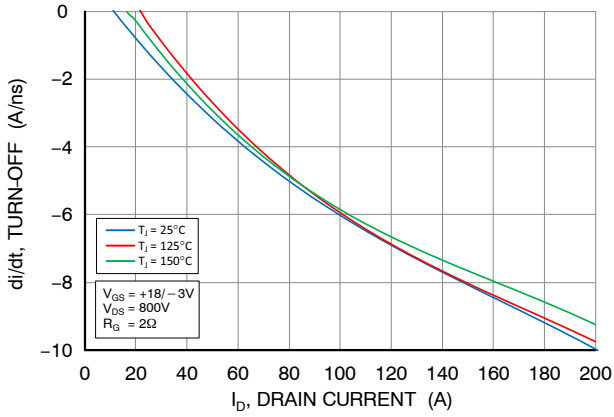

Figure 20. di/dt Turn OFF vs. Drain Current
 $V_{DS} = 800\text{ V}$

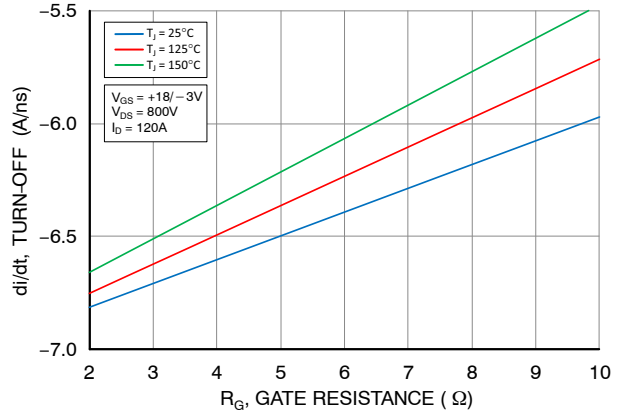

Figure 21. di/dt Turn OFF vs. Gate Resistance
 $V_{DS} = 800\text{ V}$

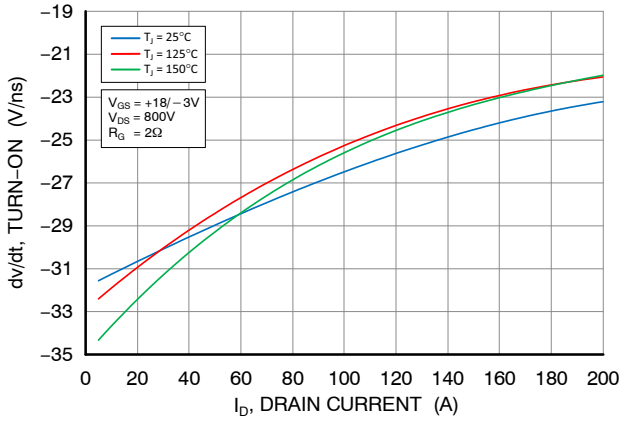

Figure 22. dv/dt Turn ON vs. Drain Current
 $V_{DS} = 800\text{ V}$

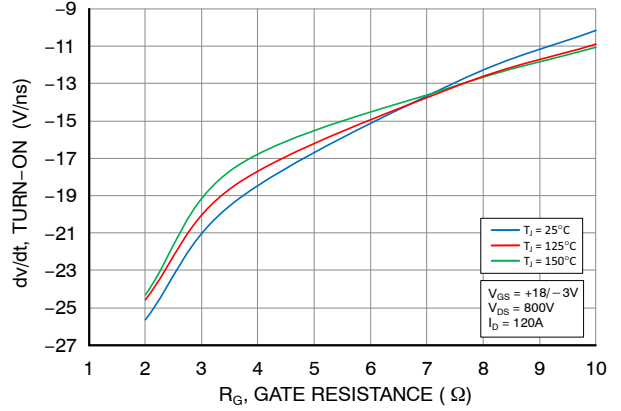

Figure 23. dv/dt Turn ON vs. Gate Resistance
 $V_{DS} = 800\text{ V}$

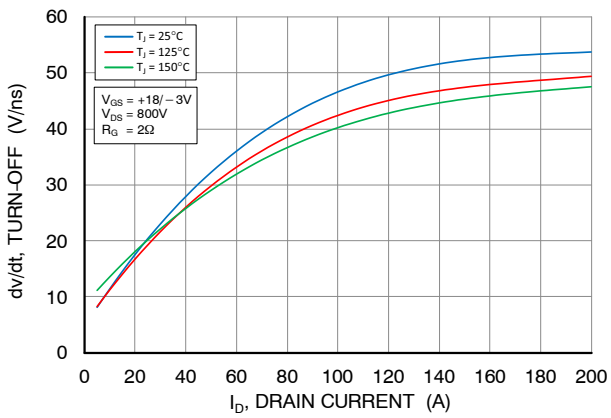

Figure 24. dv/dt Turn OFF vs. Drain Current
 $V_{DS} = 800\text{ V}$

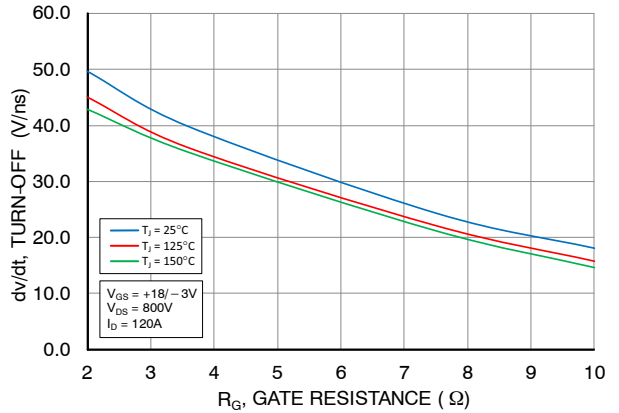

Figure 25. dv/dt Turn OFF vs. Gate Resistance
 $V_{DS} = 800\text{ V}$

NXH008P120M3F1PTG, NXH008P120M3F1PG

TYPICAL CHARACTERISTICS M1/M2 SIC MOSFET CHARACTERISTIC

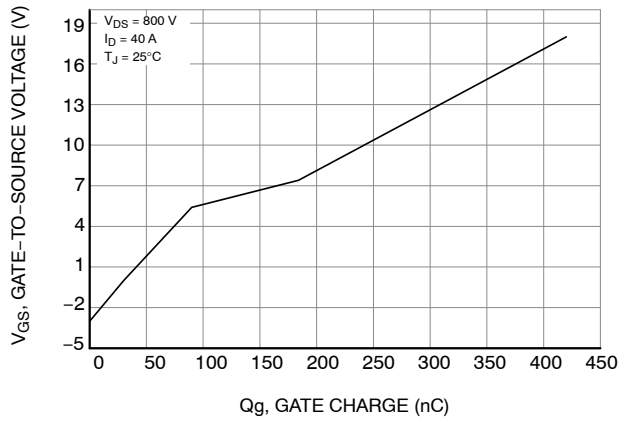

Figure 26. Gate-to-Source Voltage vs. Total Charge

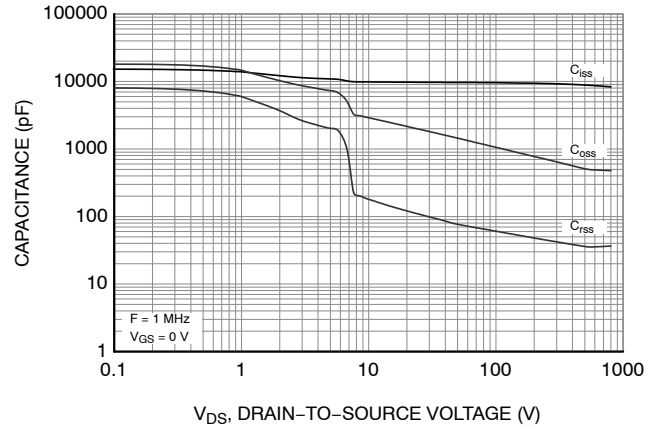

Figure 27. Capacitance vs. Drain-to-Source Voltage

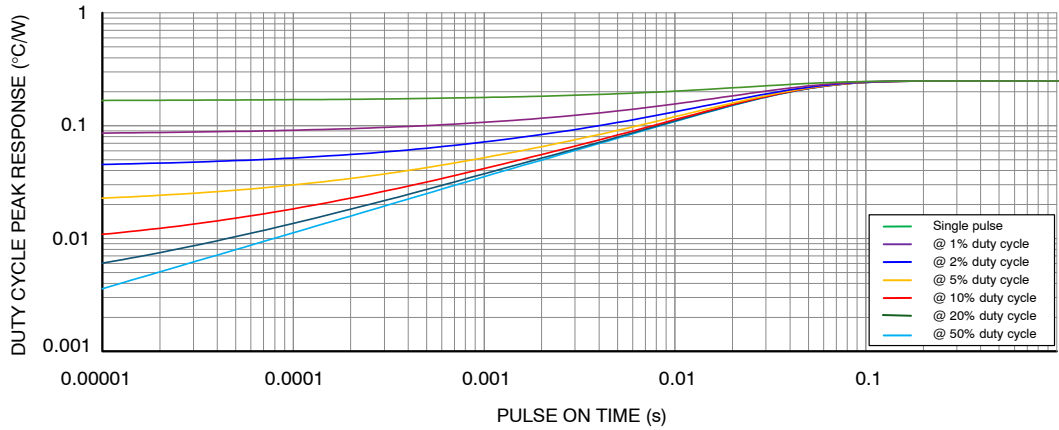

Figure 28. Duty Cycle Response vs. Pulse On Time

Table 1. CAUER NETWORKS

| Cauer Element # | Rth (K/W) | Cth (Ws/K) |
|-----------------|-----------|------------|
| 1 | 0.0015405 | 0.0032582 |
| 2 | 0.0034038 | 0.0011216 |
| 3 | 0.0167500 | 0.0053859 |
| 4 | 0.0498300 | 0.0154460 |
| 5 | 0.0925960 | 0.0870830 |
| 6 | 0.0540320 | 1.7250000 |

PIN POSITION INFORMATION

scale = 2.5 : 1

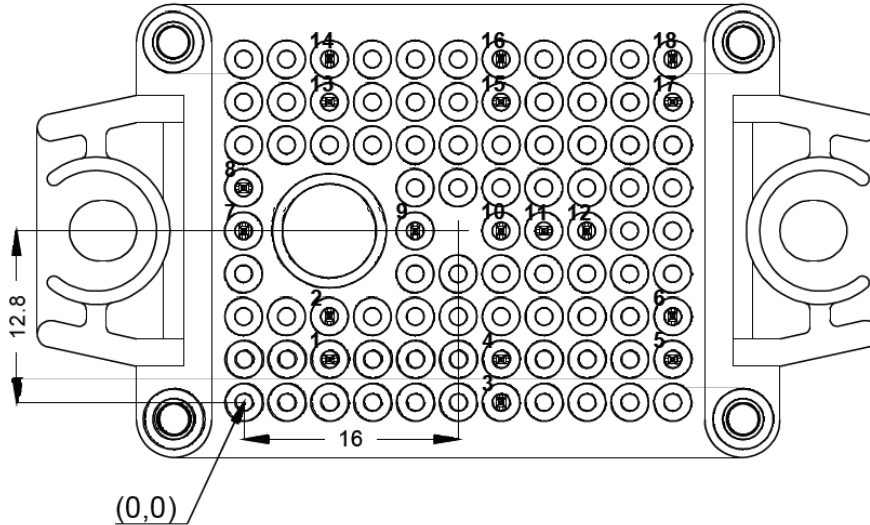

S Pin position

| Pin # | X | Y | Function | Pin # | X | Y | Function |
|-------|------|------|----------|-------|------|------|----------|
| 1 | 6.4 | 3.2 | DC+ | 10 | 19.2 | 12.8 | DC- |
| 2 | 6.4 | 6.4 | DC+ | 11 | 22.4 | 12.8 | DC- |
| 3 | 19.2 | 0.0 | S1 | 12 | 25.6 | 12.8 | DC- |
| 4 | 19.2 | 3.2 | G1 | 13 | 6.4 | 22.4 | Phase |
| 5 | 32.0 | 3.2 | DC+ | 14 | 6.4 | 25.6 | Phase |
| 6 | 32.0 | 6.4 | DC+ | 15 | 19.2 | 22.4 | G2 |
| 7 | 0.0 | 12.8 | TH2 | 16 | 19.2 | 25.6 | S2 |
| 8 | 0.0 | 16.0 | TH1 | 17 | 32.0 | 22.4 | Phase |
| 9 | 12.8 | 12.8 | DC- | 18 | 32.0 | 25.6 | Phase |

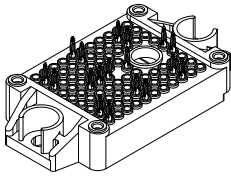

PIM18 33.8x42.5 (PRESS FIT)
CASE 180BW
ISSUE B

DATE 30 APR 2021

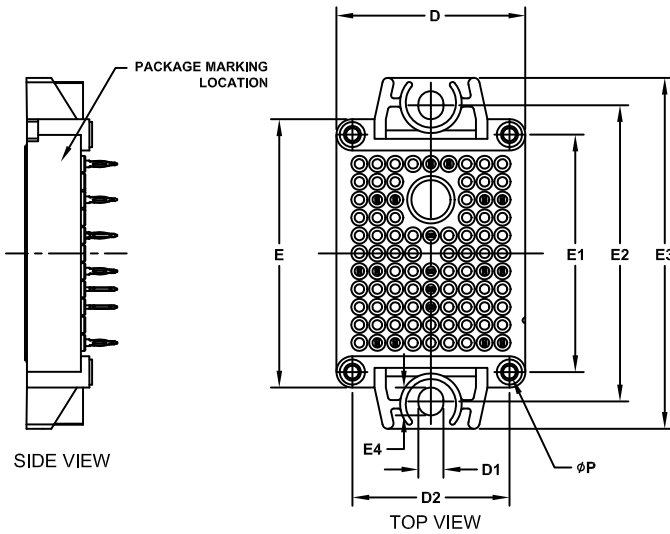

NOTES:

1. CONTROLLING DIMENSION: MILLIMETERS
2. PIN POSITION TOLERANCE IS $\pm 0.4\text{mm}$

| DIM | MILLIMETERS | | |
|-----|-------------|-------|-------|
| | MIN. | NOM. | MAX. |
| A | 11.65 | 12.00 | 12.35 |
| A1 | 16.00 | 16.50 | 17.00 |
| A2 | 0.00 | 0.35 | 0.60 |
| A3 | 12.85 | 13.35 | 13.85 |
| b | 1.15 | 1.20 | 1.25 |
| b1 | 0.59 | 0.64 | 0.69 |
| D | 33.50 | 33.80 | 34.10 |
| D1 | 4.40 | 4.50 | 4.60 |
| D2 | 27.95 | 28.10 | 28.25 |
| E | 47.70 | 48.00 | 48.30 |
| E1 | 42.35 | 42.50 | 42.65 |
| E2 | 52.90 | 53.00 | 53.10 |
| E3 | 62.30 | 62.80 | 63.30 |
| E4 | 4.90 | 5.00 | 5.10 |
| P | 2.20 | 2.30 | 2.40 |

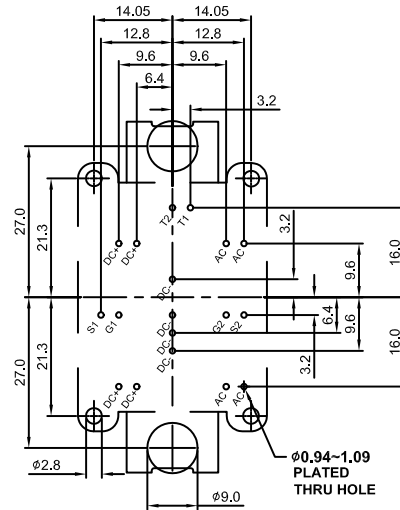
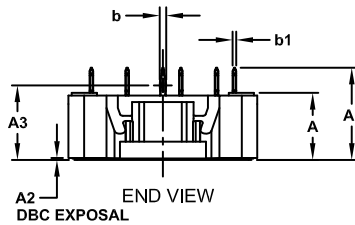

GENERIC
MARKING DIAGRAM*

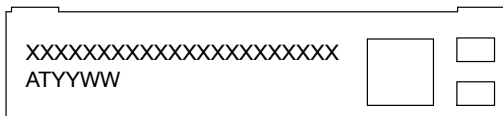

XXXXX = Specific Device Code
AT = Assembly & Test Site Code
YYWW = Year and Work Week Code

This information is generic. Please refer to device data sheet for actual part marking. Pb-Free indicator, "G" or microdot "", may or may not be present. Some products may not follow the Generic Marking.

| | | |
|-------------------------|------------------------------------|--|
| DOCUMENT NUMBER: | 98AON19723H | Electronic versions are uncontrolled except when accessed directly from the Document Repository. Printed versions are uncontrolled except when stamped "CONTROLLED COPY" in red. |
| DESCRIPTION: | PIM18 33.8x42.5 (PRESS FIT) | PAGE 1 OF 1 |

onsemi and ONSEMI are trademarks of Semiconductor Components Industries, LLC dba onsemi or its subsidiaries in the United States and/or other countries. onsemi reserves the right to make changes without further notice to any products herein. onsemi makes no warranty, representation or guarantee regarding the suitability of its products for any particular purpose, nor does onsemi assume any liability arising out of the application or use of any product or circuit, and specifically disclaims any and all liability, including without limitation special, consequential or incidental damages. onsemi does not convey any license under its patent rights nor the rights of others.

onsemi, **Onsemi**, and other names, marks, and brands are registered and/or common law trademarks of Semiconductor Components Industries, LLC dba "**onsemi**" or its affiliates and/or subsidiaries in the United States and/or other countries. **onsemi** owns the rights to a number of patents, trademarks, copyrights, trade secrets, and other intellectual property. A listing of **onsemi**'s product/patent coverage may be accessed at www.onsemi.com/site/pdf/Patent-Marking.pdf. **onsemi** reserves the right to make changes at any time to any products or information herein, without notice. The information herein is provided "as-is" and **onsemi** makes no warranty, representation or guarantee regarding the accuracy of the information, product features, availability, functionality, or suitability of its products for any particular purpose, nor does **onsemi** assume any liability arising out of the application or use of any product or circuit, and specifically disclaims any and all liability, including without limitation special, consequential or incidental damages. Buyer is responsible for its products and applications using **onsemi** products, including compliance with all laws, regulations and safety requirements or standards, regardless of any support or applications information provided by **onsemi**. "Typical" parameters which may be provided in **onsemi** data sheets and/or specifications can and do vary in different applications and actual performance may vary over time. All operating parameters, including "Typicals" must be validated for each customer application by customer's technical experts. **onsemi** does not convey any license under any of its intellectual property rights nor the rights of others. **onsemi** products are not designed, intended, or authorized for use as a critical component in life support systems or any FDA Class 3 medical devices or medical devices with a same or similar classification in a foreign jurisdiction or any devices intended for implantation in the human body. Should Buyer purchase or use **onsemi** products for any such unintended or unauthorized application, Buyer shall indemnify and hold **onsemi** and its officers, employees, subsidiaries, affiliates, and distributors harmless against all claims, costs, damages, and expenses, and reasonable attorney fees arising out of, directly or indirectly, any claim of personal injury or death associated with such unintended or unauthorized use, even if such claim alleges that **onsemi** was negligent regarding the design or manufacture of the part. **onsemi** is an Equal Opportunity/Affirmative Action Employer. This literature is subject to all applicable copyright laws and is not for resale in any manner.

ADDITIONAL INFORMATION

TECHNICAL PUBLICATIONS:

Technical Library: www.onsemi.com/design/resources/technical-documentation
onsemi Website: www.onsemi.com

ONLINE SUPPORT: www.onsemi.com/support

For additional information, please contact your local Sales Representative at www.onsemi.com/support/sales