

Half-Bridge IGBT Module, Qdual3

1200 V, 800 A

NXH800H120L7QDSG

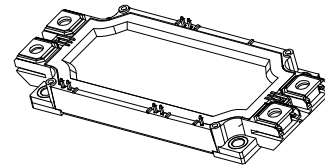

PIM11, 152.00 x 62.15 x 20.80
CASE 180HT

General Description

The NXH800H120L7QDSG is a 1200 V 800 A rated half bridge IGBT power module. The integrated Field Stop Trench 7 IGBTs and Gen. 7 diodes provide lower conduction losses and switching losses, enabling designers to achieve high efficiency and superior reliability.

Features

- 1200 V, 800 A 2 in 1 Half Bridge Configuration IGBT Power Module
- Field Stop Trench 7 IGBTs & Gen.7 Diodes
- NTC Thermistor
- Isolated Base Plate
- Solderable Pins
- Low Inductive Layout
- This is a Pb-Free Device

Typical Applications

- Motor Drives
- Servo Drives
- Solar Drives
- Uninterruptible Power Supply Systems (UPS)

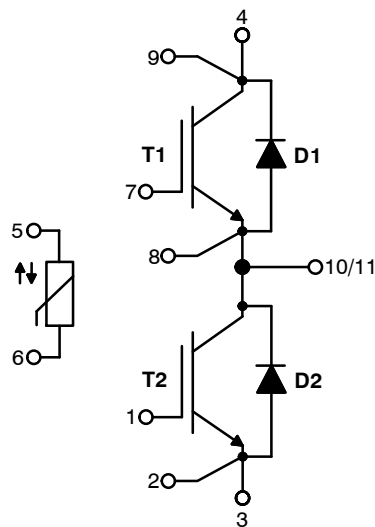

Figure 1. Schematic

MARKING DIAGRAM



NXH800H120L7QDSG = Device Code
AT = Assembly & Test Site Code
YYWW = Year and Work Week Code

PIN ASSIGNMENTS

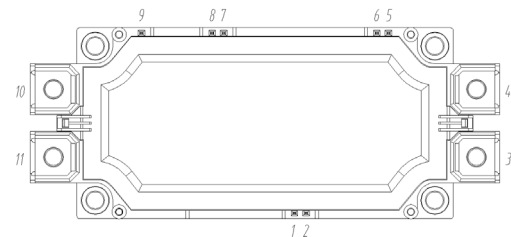

ORDERING INFORMATION

Device	Package	Shipping
NXH800H120L7QDSG	PIM11 (Pb-Free)	8 Units / Blister Tray

PIN DESCRIPTION

Pin	Name	Description
1	G2	T2 Gate
2	E2	T2 Emitter
3	DC-	DC Negative Bus Connection
4	DC+	DC Positive Bus Connection
5	TH2	Thermistor Connection 2
6	TH1	Thermistor Connection 1
7	G1	T1 Gate
8	E1	T1 Emitter
9	CS1	T1 Collector Sensing
10	OUT	Center Point of Half Bridge
11	OUT	Center Point of Half Bridge

NXH800H120L7QDSG

Table 1. ABSOLUTE MAXIMUM RATINGS ($T_{vj} = 25^{\circ}\text{C}$ unless otherwise specified)

Symbol	Parameter	Conditions	Value	Unit
IGBT // Diode				
V_{CES}	Collector-Emitter Voltage	Gate-emitter = 0 V	1200	V
V_{GES}	Gate-Emitter Voltage	Collector-emitter = 0 V	± 20	V
I_C	Continuous Collector Current	$T_C = 90^{\circ}\text{C}$	± 800	A
I_{PULSE}	Repetitive Pulsed Collector Current	$T_C = 25^{\circ}\text{C}$, $t_p = 1$ ms	± 1600	A
T_{vjop}	Operating Junction Temperature		-40~175	$^{\circ}\text{C}$
T_{SCWT}	Short Circuit Withstand Time, Non Repetitive	$V_{GE} \leq 15$ V, $V_{DC+} \leq 800$ V	8	μs

MODULE

V_{ISO}	Isolation Voltage	RMS, $f = 60$ HZ, pins to base plate	3.4	kV
T_{STG}	Storage Temperature		-40~125	$^{\circ}\text{C}$
M_T	Mounting torque to main terminals (Note 1)	M6 screw	6.0	N·m
M_H	Mounting torque to heat sink (Note 1)	M5 screw		

Stresses exceeding those listed in the Maximum Ratings table may damage the device. If any of these limits are exceeded, device functionality should not be assumed, damage may occur and reliability may be affected.

1. Recommendable value: 3.0 ~ 6.0 N·m

Table 2. THERMAL RESISTANCE CHARACTERISTICS

Symbol	Parameter	Condition	Min	Typ	Max	Unit
R_{thJCQ}	Junction to Case Thermal Resistance (Note 2)	Per IGBT	-	-	0.0498	$^{\circ}\text{C}/\text{W}$
R_{thJCD}		Per diode	-	-	0.0889	
R_{thCHQ}	Case to Heat-Sink Thermal Resistance (Note 2)	Per IGBT, 1 W/(m·K) thermal grease	-	0.0282	-	
R_{thCHD}		Per diode, 1 W/(m·K) thermal grease	-	0.0342	-	

2. Data from characterization.

Table 3. THERMISTOR CHARACTERISTICS

Symbol	Parameter	Condition	Min	Typ	Max	Unit
R_{25}	Nominal Resistance	$T_{NTC} = 25^{\circ}\text{C}$	-	5	-	$\text{k}\Omega$
R_{100}		$T_{NTC} = 100^{\circ}\text{C}$	-	493.3	-	Ω
$\Delta R/R$	Deviation on R_{100}	$T_{NTC} = 100^{\circ}\text{C}$	-5	-	5	%
P_D	Power Dissipation – Recommended Limit	0.15 mA, non-self-heating effect	-	0.1	-	mW
	Power Dissipation – Absolute Maximum	5 mA	-	-	34.2	mW
	Power Dissipation Constant		-	1.4	-	$\text{mW}/^{\circ}\text{C}$
$B_{25/50}$	B-Value	B(25/50), tolerance ± 2 %	-	3375	-	K
$B_{25/100}$	B-Value	B(25/100), tolerance ± 2 %	-	3436	-	K

NXH800H120L7QDSG

Table 4. ELECTRICAL CHARACTERISTICS ($T_{vj} = 25^{\circ}\text{C}$ unless otherwise specified)

Symbol	Parameter	Test Conditions	Min	Typ	Max	Unit	
IGBT							
$V_{CE(SAT)}$ (Pin 8-9)	Collector-Emitter Saturation Voltage	$V_{GE} = 15\text{ V}, I_C = 800\text{ A}$	$T_{vj} = 25^{\circ}\text{C}$	-	1.65	2.05	V
$V_{CE(SAT)}$ (Chip) (Note 3)			$T_{vj} = 25^{\circ}\text{C}$	-	1.44	1.85	
			$T_{vj} = 125^{\circ}\text{C}$	-	1.63	-	
			$T_{vj} = 175^{\circ}\text{C}$	-	1.75	-	
$V_{GE(TH)}$	Gate-Emitter Threshold Voltage	$V_{CE} = V_{GE}, I_C = 80\text{ mA}$	4.5	5.5	6.5	V	
Q_g	Gate Charge	$V_{CE} = 600\text{ V}, V_{GE} = \pm 15\text{ V}, I_C = 800\text{ A}$	-	5.6	-	μC	
R_{gint}	Internal Gate Resistor		-	1.5	-	Ω	
C_{ies}	Input Capacitance	$V_{CE} = 25\text{ V}, V_{GE} = 0\text{ V}, f = 100\text{ kHz}, T_{vj} = 25^{\circ}\text{C}$	-	94.3	-	nF	
C_{oes}	Output Capacitance		-	3.9	-		
C_{res}	Reverse Transfer Capacitance		-	0.58	-		
I_{CES}	Collector-Emitter Cut Off Current	$V_{CE} = 1200\text{ V}, V_{GE} = 0\text{ V}$	-	-	100	μA	
I_{GES}	Gate-Emitter Leakage Current	$V_{CE} = 0\text{ V}, V_{GE} = 20\text{ V}$	-	-	80	nA	
t_{don}	Turn-on Delay Time	$V_{CE} = 600\text{ V}, V_{GE} = \pm 15\text{ V}, R_g = 0.5\ \Omega, I_C = 800\text{ A},$ Inductive load	$T_{vj} = 25^{\circ}\text{C}$	-	0.37	-	μs
			$T_{vj} = 125^{\circ}\text{C}$	-	0.41	-	
			$T_{vj} = 175^{\circ}\text{C}$	-	0.42	-	
t_r	Rise Time		$T_{vj} = 25^{\circ}\text{C}$	-	0.14	-	μs
			$T_{vj} = 125^{\circ}\text{C}$	-	0.15	-	
			$T_{vj} = 175^{\circ}\text{C}$	-	0.15	-	
t_{doff}	Turn-off Delay Time		$T_{vj} = 25^{\circ}\text{C}$	-	0.4	-	μs
			$T_{vj} = 125^{\circ}\text{C}$	-	0.42	-	
			$T_{vj} = 175^{\circ}\text{C}$	-	0.44	-	
t_f	Fall Time	$T_{vj} = 25^{\circ}\text{C}$	-	0.1	-	μs	
		$T_{vj} = 125^{\circ}\text{C}$	-	0.17	-		
		$T_{vj} = 175^{\circ}\text{C}$	-	0.21	-		
E_{on}	Turn-on Energy Loss per Pulse	$T_{vj} = 25^{\circ}\text{C}$	-	87.4	-	mJ	
		$T_{vj} = 125^{\circ}\text{C}$	-	112	-		
		$T_{vj} = 175^{\circ}\text{C}$	-	132.6	-		
E_{off}	Turn-off Energy Loss per Pulse	$T_{vj} = 25^{\circ}\text{C}$	-	69.8	-	mJ	
		$T_{vj} = 125^{\circ}\text{C}$	-	90.1	-		
		$T_{vj} = 175^{\circ}\text{C}$	-	102.0	-		

NXH800H120L7QDSG

Table 4. ELECTRICAL CHARACTERISTICS ($T_{vj} = 25^{\circ}\text{C}$ unless otherwise specified) (continued)

Symbol	Parameter	Test Conditions	Min	Typ	Max	Unit	
DIODE							
V_F (Pin 8-9)	Diode Forward Voltage	$V_{GE} = 0\text{ V}, I_F = 800\text{ A}$	$T_{vj} = 25^{\circ}\text{C}$	-	1.86	2.25	V
V_F (Chip) (Note 3)			$T_{vj} = 25^{\circ}\text{C}$	-	1.64	2.05	
			$T_{vj} = 125^{\circ}\text{C}$	-	1.62	-	
			$T_{vj} = 175^{\circ}\text{C}$	-	1.57	-	
I_{RRM}	Peak Reverse Recovery Current	$V_{CE} = 600\text{ V}, V_{GE} = \pm 15\text{ V}, R_g = 0.5\ \Omega, I_C = 800\text{ A}$ Inductive load	$T_{vj} = 25^{\circ}\text{C}$	-	229	-	A
			$T_{vj} = 125^{\circ}\text{C}$	-	346	-	
			$T_{vj} = 175^{\circ}\text{C}$	-	399	-	
Q_{rr}	Reverse Recovery Charge		$T_{vj} = 25^{\circ}\text{C}$	-	37.6	-	μC
			$T_{vj} = 125^{\circ}\text{C}$	-	90.5	-	
			$T_{vj} = 175^{\circ}\text{C}$	-	126.6	-	
E_{rec}	Reverse Recovery Energy Loss per Pulse	$T_{vj} = 25^{\circ}\text{C}$	-	14.0	-	mJ	
		$T_{vj} = 125^{\circ}\text{C}$	-	36.4	-		
		$T_{vj} = 175^{\circ}\text{C}$	-	52.6	-		

Product parametric performance is indicated in the Electrical Characteristics for the listed test conditions, unless otherwise noted. Product performance may not be indicated by the Electrical Characteristics if operated under different conditions.
 3. This parameter is only guaranteed by design.

Table 5. MODULE AND MECHANICAL CHARACTERISTICS

Symbol	Parameter	Condition	Min	Typ	Max	Unit
CTI	Comparative Tracking Index		>175	-	-	
D_{CR}	Creepage Distance	Terminal to terminal	-	13.0	-	mm
		Terminal to heatsink	-	15.0	-	mm
D_{CL}	Clearance Distance	Terminal to terminal	-	10.0	-	mm
		Terminal to heatsink	-	12.5	-	mm
M_{LS}	Module Stray Inductance		-	20	-	nH
M_W	Module Weight		-	330	-	g

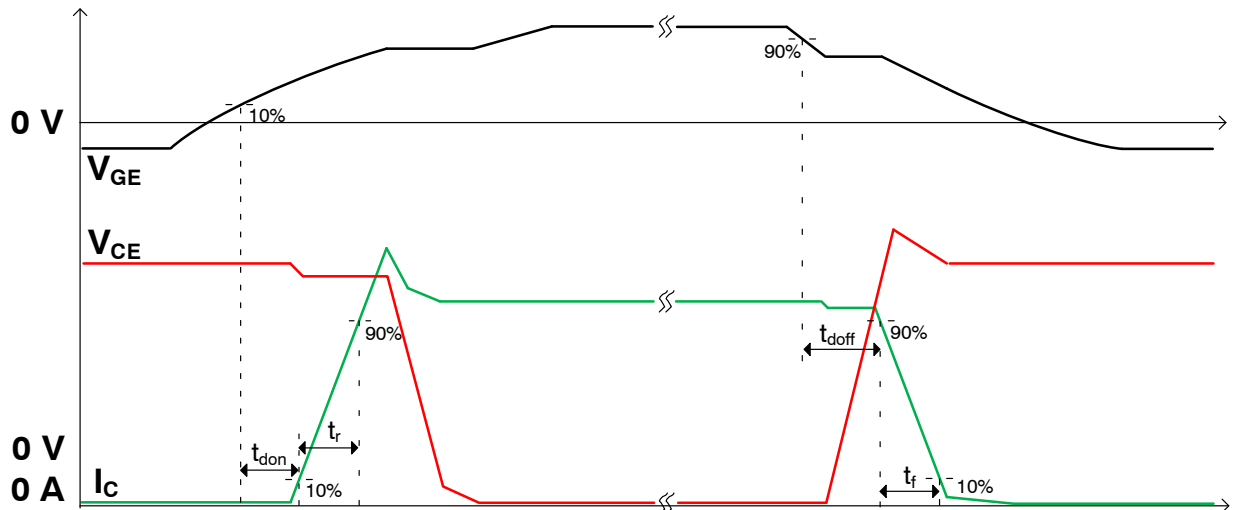

Figure 2. Switching Time Definition

NXH800H120L7QDSG

TYPICAL CHARACTERISTICS

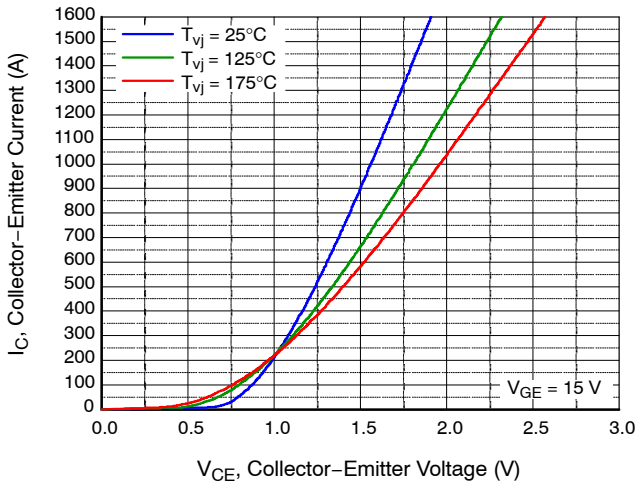

Figure 1. Output Characteristic, IGBT (Typ.)

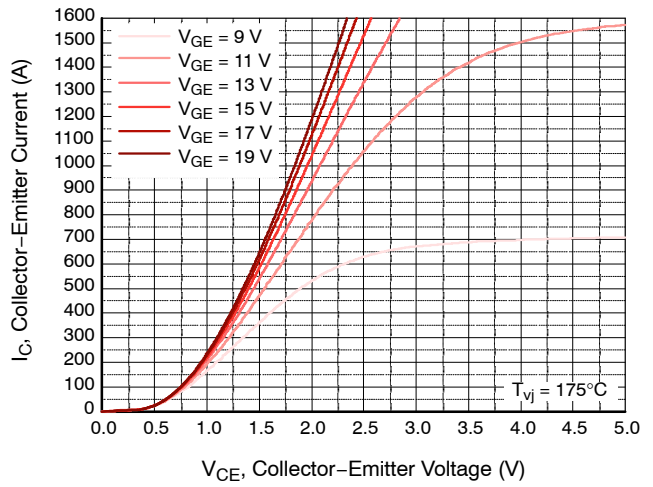

Figure 2. Output Characteristic, IGBT (Typ.)

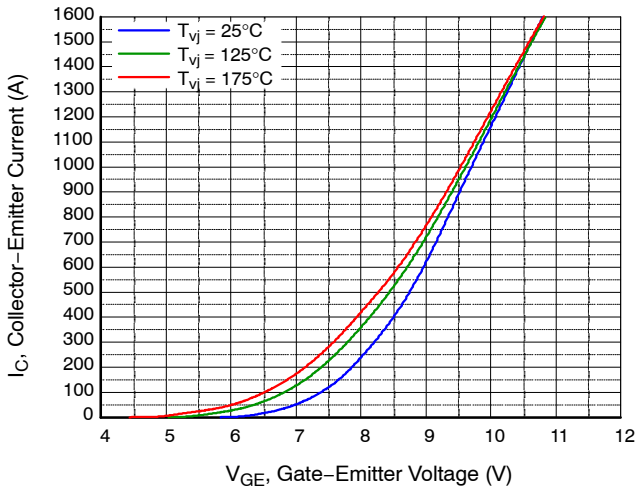

Figure 3. Transfer Characteristic, IGBT (Typ.)

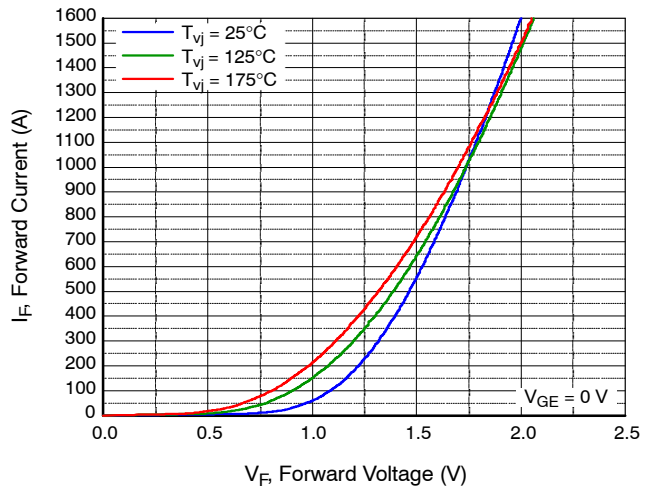

Figure 4. Forward Characteristic, Diode (Typ.)

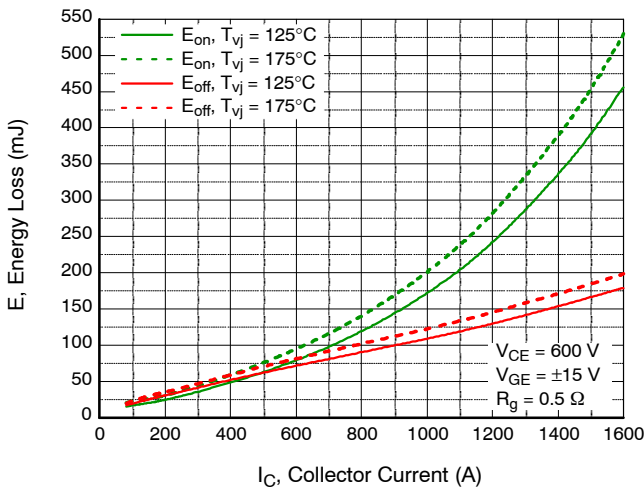

Figure 5. Switching Losses Characteristic, IGBT (Typ.)

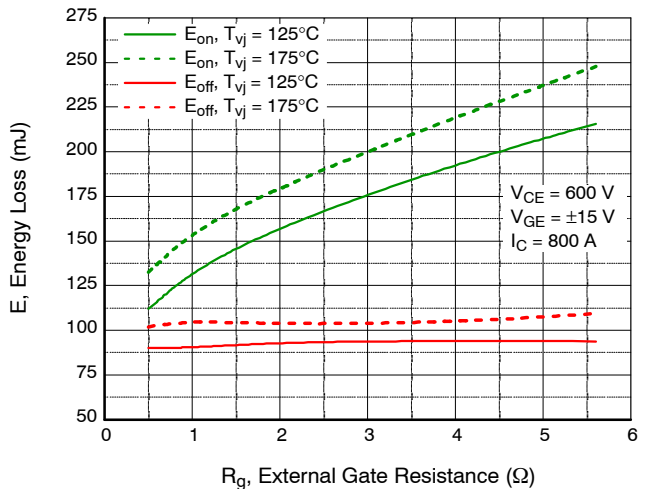

Figure 6. Switching Losses Characteristic, IGBT (Typ.)

NXH800H120L7QDSG

TYPICAL CHARACTERISTICS (continued)

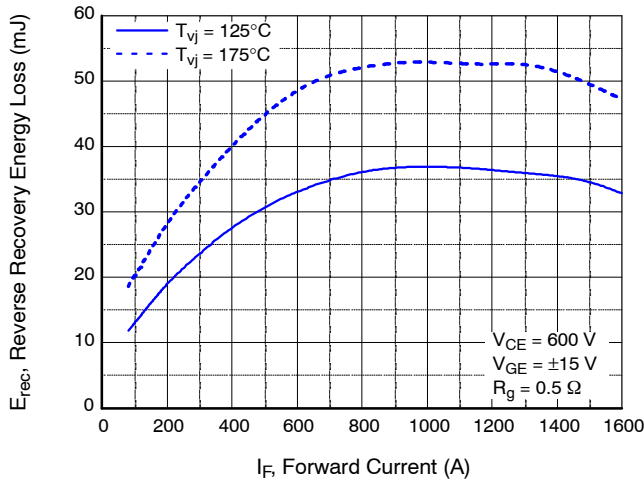

Figure 7. Switching Losses Characteristic, Diode (Typ.)

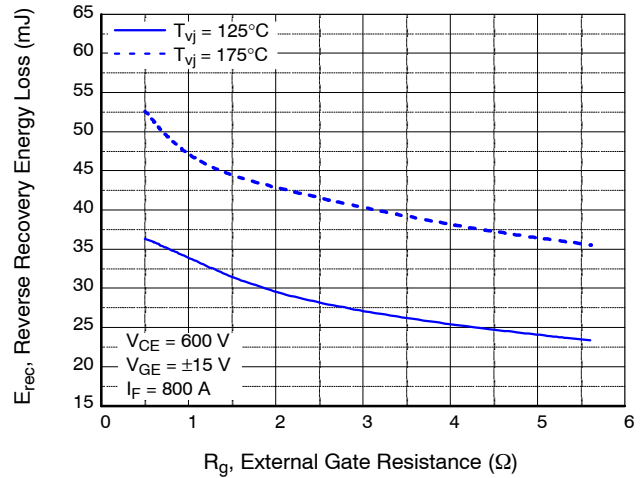

Figure 8. Switching Losses Characteristic, Diode (Typ.)

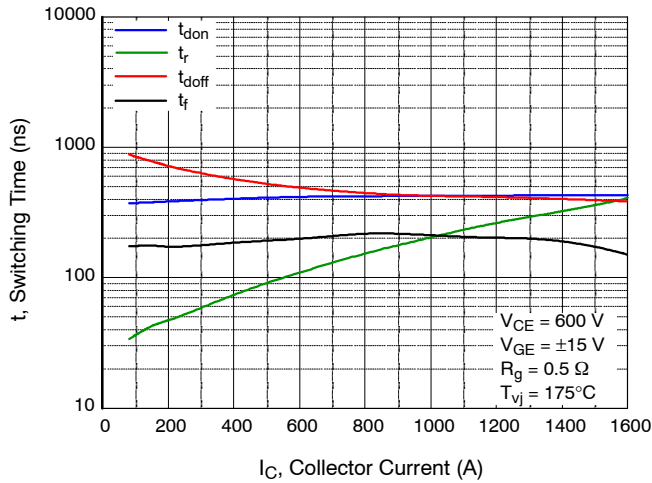

Figure 9. Switching Time Characteristic, IGBT (Typ.)

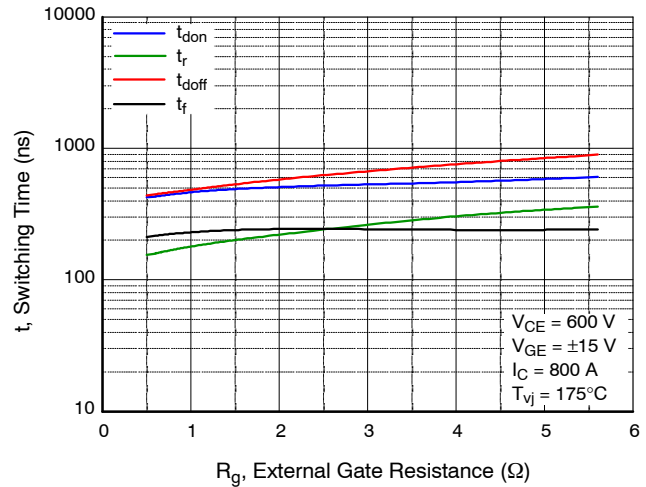

Figure 10. Switching Time Characteristic, IGBT (Typ.)

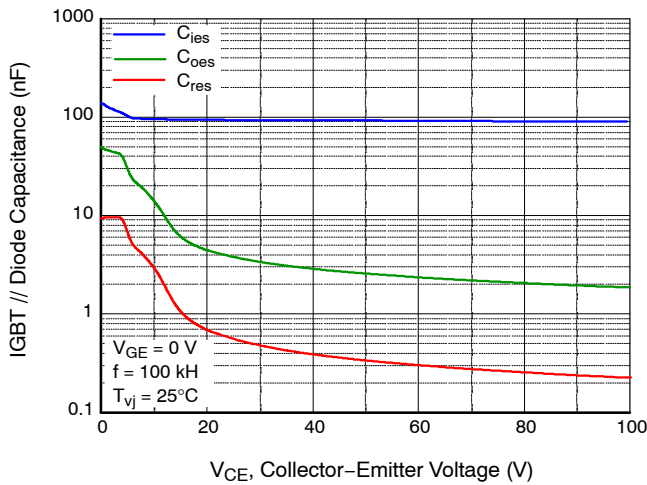

Figure 11. Capacity Characteristic, IGBT // Diode (Typ.)

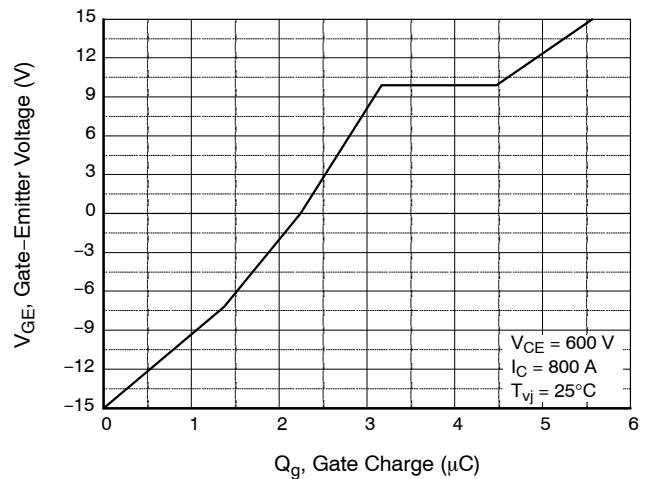

Figure 12. Gate Charge Characteristic, IGBT (Typ.)

NXH800H120L7QDSG

TYPICAL CHARACTERISTICS (continued)

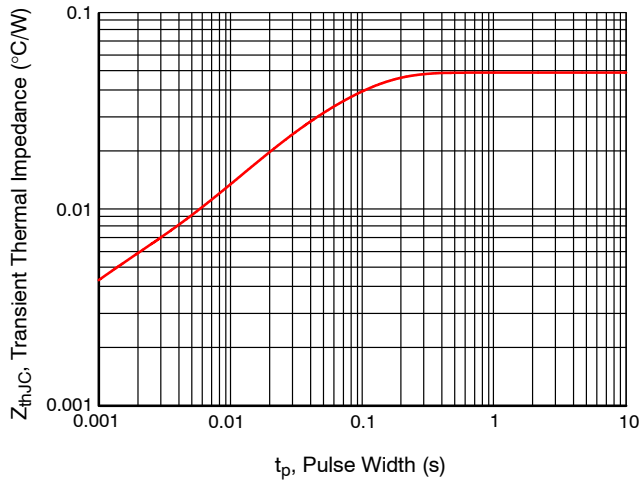

Figure 13. Transient Thermal Impedance, IGBT (Max.)

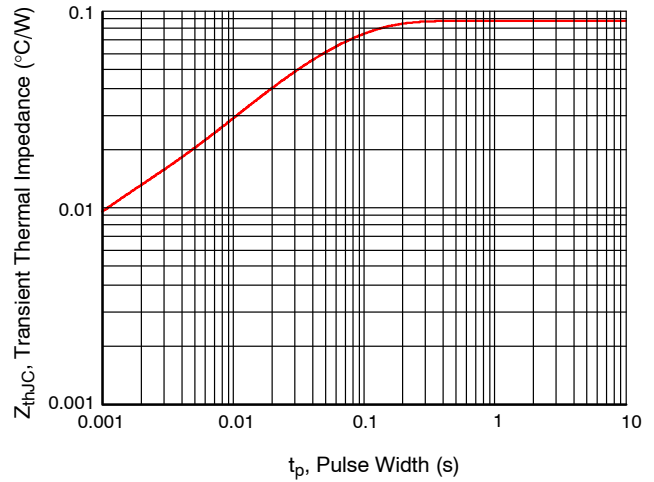

Figure 14. Transient Thermal Impedance, Diode (Max.)

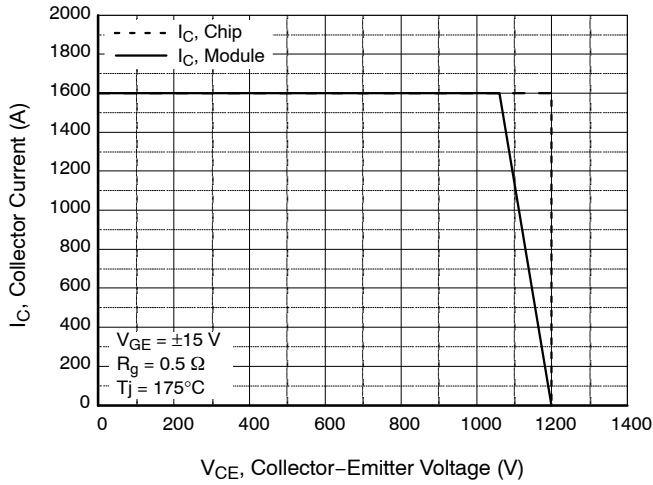

Figure 15. Reverse Bias Safe Operating Area, IGBT // Diode

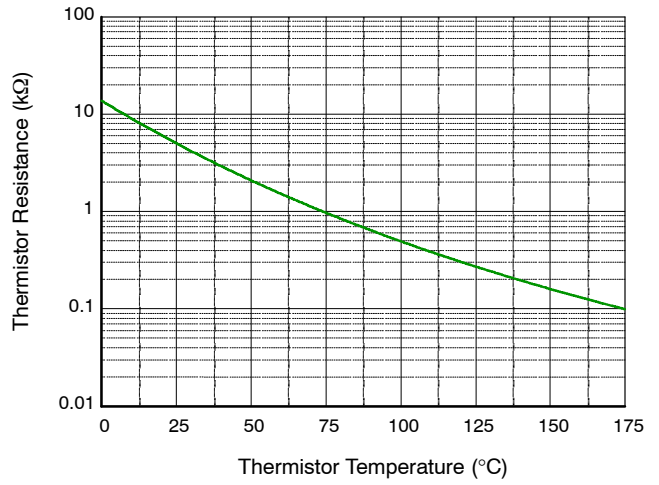
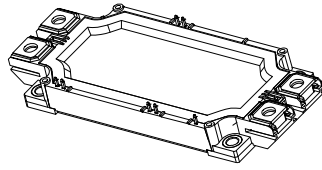

Figure 16. NTC Thermistor R-T Value (Typ.)



PIM11, 152.00x62.15x17.00
CASE 180HT
ISSUE E

DATE 28 MAY 2024

- NOTES:
1. DIMENSIONING AND TOLERANCING PER ASME Y14.5-2018.
 2. CONTROLLING DIMENSION - MILLIMETERS
 3. DIMENSIONS b AND b1 APPLY TO THE PLATED TERMINALS AND ARE MEASURED AT DIMENSION A1
 4. PIN POSITION TOLERANCE IS ± 0.25 mm
 5. PACKAGE MARKING IS LOCATED AS SHOWN ON THE SIDE OPPOSITE THE PACKAGE ORIENTATION FEATURES
 6. SOLDER PIN

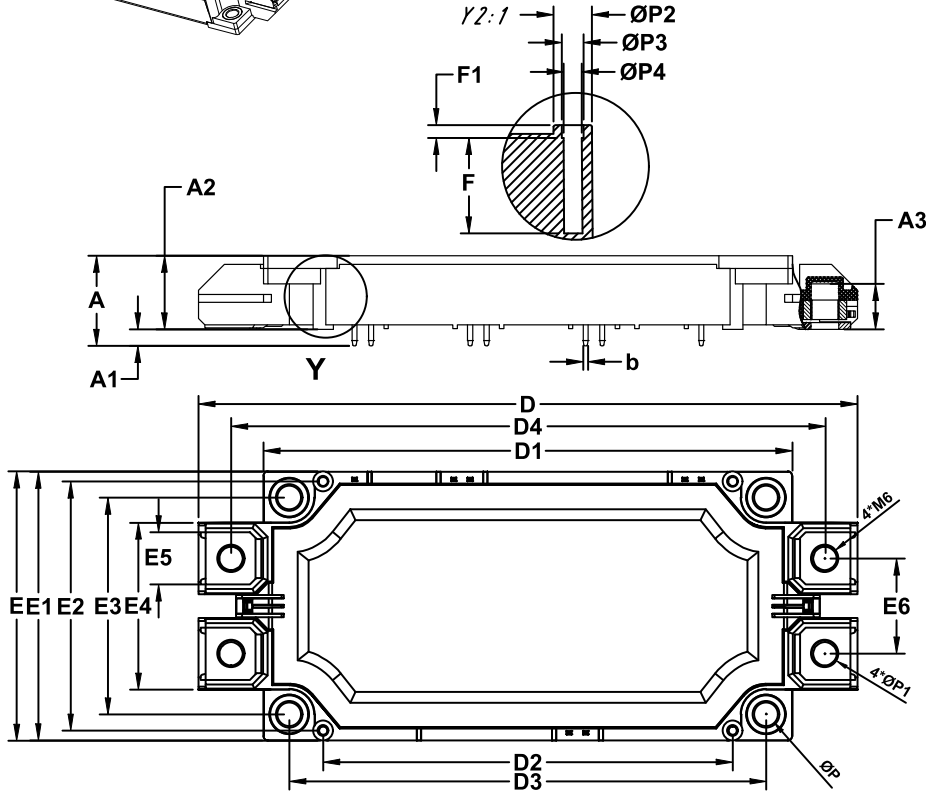

DIM	MILLIMETERS		
	MIN.	NOM.	MAX.
A	20.00	20.80	21.60
A1	3.50	3.80	4.10
A2	16.50	17.00	17.50
A3	10.00	10.5	11.00
A4	6.30	6.50	6.70
b	1.12	1.15	1.18
D	151.5	152.00	152.50
D1	121.50	122.00	122.50
D2	94.30	94.50	94.70
D3	109.80	110.00	110.20
E	61.95	62.15	62.35
E1	61.80	62.00	62.20
E2	57.30	57.50	57.70
E3	49.80	50.00	50.20
E4	38.40	38.60	38.80
E5	11.80	12.00	12.20
F	11.00	11.00	11.20
F1	1.40	1.45	1.50
P	5.20	5.50	5.60
P1	6.40	6.40	6.60
P2	4.45	4.65	4.85
P3	2.40	2.50	2.50
P4	2.05	2.10	2.10
D4	136.40	137.00	137.60
E6	21.60	22.00	22.40

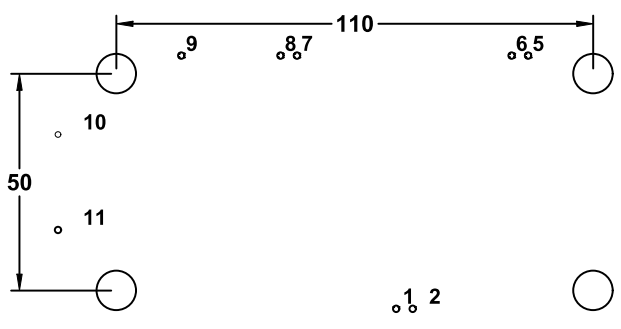
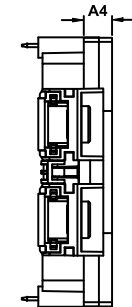

RECOMMENDED MOUNTING PATTERN

* For additional information on our Pb-Free strategy and soldering details, please download the Onsemi Soldering and Mounting Techniques Reference Manual, SOLDERRM/D.

Pin table			
Pin	X	Y	Function
1	9.52	-29.2	T2
2	13.33	-29.2	DC-
3	68.5	-11.0	DC-
4	68.5	11.0	DC+
5	40.0	29.2	TH2
6	36.19	29.2	TH1
7	-13.33	29.2	T1
8	-17.14	29.2	AC
9	-40.0	29.2	DC+
10	-68.5	11.0	AC
11	-68.5	-11.0	AC

GENERIC MARKING DIAGRAM*



XXXXX = Specific Device Code
AT = Assembly & Test Site Code
YYYYWW = Year and Work Week Code

This information is generic. Please refer to device data sheet for actual part marking. Pb-Free indicator, "G" or microdot "", may or may not be present. Some products may not follow the Generic Marking.

DOCUMENT NUMBER:	98AON55209H	Electronic versions are uncontrolled except when accessed directly from the Document Repository. Printed versions are uncontrolled except when stamped "CONTROLLED COPY" in red.
DESCRIPTION:	PIM11, 152.00x62.15x17.00	PAGE 1 OF 1

onsemi and ONSEMI are trademarks of Semiconductor Components Industries, LLC dba onsemi or its subsidiaries in the United States and/or other countries. onsemi reserves the right to make changes without further notice to any products herein. onsemi makes no warranty, representation or guarantee regarding the suitability of its products for any particular purpose, nor does onsemi assume any liability arising out of the application or use of any product or circuit, and specifically disclaims any and all liability, including without limitation special, consequential or incidental damages. onsemi does not convey any license under its patent rights nor the rights of others.

onsemi, **Onsemi**, and other names, marks, and brands are registered and/or common law trademarks of Semiconductor Components Industries, LLC dba "**onsemi**" or its affiliates and/or subsidiaries in the United States and/or other countries. **onsemi** owns the rights to a number of patents, trademarks, copyrights, trade secrets, and other intellectual property. A listing of **onsemi**'s product/patent coverage may be accessed at www.onsemi.com/site/pdf/Patent-Marking.pdf. **onsemi** reserves the right to make changes at any time to any products or information herein, without notice. The information herein is provided "as-is" and **onsemi** makes no warranty, representation or guarantee regarding the accuracy of the information, product features, availability, functionality, or suitability of its products for any particular purpose, nor does **onsemi** assume any liability arising out of the application or use of any product or circuit, and specifically disclaims any and all liability, including without limitation special, consequential or incidental damages. Buyer is responsible for its products and applications using **onsemi** products, including compliance with all laws, regulations and safety requirements or standards, regardless of any support or applications information provided by **onsemi**. "Typical" parameters which may be provided in **onsemi** data sheets and/or specifications can and do vary in different applications and actual performance may vary over time. All operating parameters, including "Typicals" must be validated for each customer application by customer's technical experts. **onsemi** does not convey any license under any of its intellectual property rights nor the rights of others. **onsemi** products are not designed, intended, or authorized for use as a critical component in life support systems or any FDA Class 3 medical devices or medical devices with a same or similar classification in a foreign jurisdiction or any devices intended for implantation in the human body. Should Buyer purchase or use **onsemi** products for any such unintended or unauthorized application, Buyer shall indemnify and hold **onsemi** and its officers, employees, subsidiaries, affiliates, and distributors harmless against all claims, costs, damages, and expenses, and reasonable attorney fees arising out of, directly or indirectly, any claim of personal injury or death associated with such unintended or unauthorized use, even if such claim alleges that **onsemi** was negligent regarding the design or manufacture of the part. **onsemi** is an Equal Opportunity/Affirmative Action Employer. This literature is subject to all applicable copyright laws and is not for resale in any manner.

ADDITIONAL INFORMATION

TECHNICAL PUBLICATIONS:

Technical Library: www.onsemi.com/design/resources/technical-documentation
onsemi Website: www.onsemi.com

ONLINE SUPPORT: www.onsemi.com/support

For additional information, please contact your local Sales Representative at www.onsemi.com/support/sales

