

## 5 AMP LOW DROPOUT POSITIVE ADJUSTABLE REGULATOR APPROVED TO DESC DRAWING 5962-89521

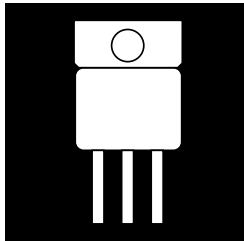

**Three Terminal, Positive Adjustable  
Low Dropout Voltage Regulator In  
Hermetic Packages**

### FEATURES

- Similar To Industry Standard LT1084
- Approved To DESC Standardized Military Drawing Number 5962-89521
- Adjustable Output Voltage
- Built In Thermal Overload Protection
- Short Circuit Current Limiting
- Maximum Output Voltage Tolerance is Guaranteed To  $\pm 1\%$
- Guaranteed Dropout Voltage At Multiple Current Levels
- TO-258 Available in Isolated and Non-Isolated Packages

### DESCRIPTION

This three terminal positive adjustable voltage regulator is designed to provide 5A with higher efficiency than conventional voltage regulators. This device is designed to operate down to 1 Volt input to output differential and the dropout voltage is fully specified as a function of load current. Supplied in easy-to-use hermetic TO-258 and TO-3 packages, this device is ideally suited for Military applications where small size and high reliability is required.

### ABSOLUTE MAXIMUM RATINGS @ 25°C

Power Dissipation ( $P_d$ )	Internally Limited
Input - Output Voltage Differential	35 V
Operating Junction Temperature Range	- 55°C to + 150°C
Storage Temperature Range	- 65°C to + 150°C
Lead Temperature (Soldering 10 seconds)	300°C
Thermal Resistance:	
$\theta_{JC}$ (TO-258 Isolated)	3.0°C/W
$\theta_{JC}$ (TO-258 Non-Isolated)	2.3°C/W
$\theta_{JC}$ (TO-3)	3.0°C/W
Maximum Output Current	5.0 A
Recommended Operating Conditions:	
Output Voltage Range	3.3V to 15 V
Ambient Operating Temperature Range ( $T_A$ )	- 55°C to + 125°C
Input Voltage Range	5V to 25 V

3.3

OM1840SCM OM1840NCM OM1840NKM

**ELECTRICAL CHARACTERISTICS**  $-55^{\circ}\text{C} \leq T_A \leq +125^{\circ}\text{C}$  (unless otherwise specified)

Parameter	Symbol	Test Conditions	Min.	Max.	Unit
Reference Voltage	$V_{REF}$	$ V_{IN} - V_{OUT}  = 3.0\text{ V}$ , $I_{OUT} = 10\text{ mA}$ , $T_A = 25^{\circ}\text{C}$	1.238	1.262	V
		$1.5\text{ V} \leq  V_{IN} - V_{OUT}  \leq 25\text{ V}$ , $I_{OUT} = 10\text{ mA}$ , $I_{FL} = 3.0\text{ A}$	• 1.225	1.270	V
Line Regulation (Note 1)	$\frac{\Delta V_{OUT}}{\Delta V_{IN}}$	$1.5\text{ V} \leq  V_{IN} - V_{OUT}  \leq 15\text{ V}$ , $I_{OUT} = 10\text{ mA}$ , $T_A = 25^{\circ}\text{C}$		0.2	%
		$15\text{ V} \leq  V_{IN} - V_{OUT}  \leq 35\text{ V}$ , $I_{OUT} = 10\text{ mA}$	•	0.5	%
Load Regulation (Note 1)	$\frac{\Delta V_{OUT}}{\Delta I_{OUT}}$	$ V_{IN} - V_{OUT}  = 3.0\text{ V}$ , $T_A = 25^{\circ}\text{C}$ $I_{OUT} = 10\text{ mA}$ , $I_{FL} = 3.0\text{ A}$		0.3	%
			•	0.4	%
Dropout Voltage	$V_{DO}$	$I_{FL} = 3.0\text{ A}$ , $\Delta V_{REF} = 1\%$	•	1.5	V
Thermal Regulation	-	30 ms pulse, $T_A = +25^{\circ}\text{C}$		0.015	%/W
Ripple Rejection	$\frac{\Delta V_{IN}}{\Delta V_{OUT}}$	$f = 120\text{ Hz}$ , $C_{Adj} = 25\text{ }\mu\text{F}$ , $C_{OUT} = 25\text{ }\mu\text{F}$ (tantalum), $I_{FL} = 3.0\text{ A}$ , $ V_{IN} - V_{OUT}  = 3.0\text{ V}$	• 60		dB
Adjust Pin Current	$I_{Adj}$	$1.5\text{ V} \leq  V_{IN} - V_{OUT}  \leq 25\text{ V}$ , $I_{OUT} = 10\text{ mA}$ , $I_{FL} = 3.0\text{ A}$	•	120	$\mu\text{A}$
Adjust Pin Current Change	$\Delta I_{Adj}$	$1.5\text{ V} \leq  V_{IN} - V_{OUT}  \leq 25\text{ V}$ , $10\text{ mA} \leq I_{OUT} \leq 3.0\text{ A}$	•	5.0	$\mu\text{A}$
Minimum Load Current	$I_{Min}$	$ V_{IN} - V_{OUT}  = 25\text{ V}$	•	10	mA
Current Limit	$I_{Lim}$	$ V_{IN} - V_{OUT}  \leq 5.0\text{ V}$	• 5.5		A
		$ V_{IN} - V_{OUT}  = 25\text{ V}$	• 0.3		A
Temperature Stability (Note 2)	$\frac{\Delta V_{OUT}}{\Delta T}$	$-55^{\circ}\text{C} \leq T_J \leq +125^{\circ}\text{C}$	•	1.5	%
Long Term Stability (Note 2)	$\frac{\Delta V_{OUT}}{\Delta T}$	$T_A = +125^{\circ}\text{C}$ , $t = 1000\text{ hrs}$		1.0	%

**Notes:**

- Line and Load Regulation are measured at a constant junction temperature using a low duty cycle pulse technique. Although power dissipation is internally limited, regulation is guaranteed up to the maximum power dissipation of 45 W. Power dissipation is determined by the input/output differential voltage and the output current. Guaranteed maximum power dissipation will not be available over the full input/output voltage range.
- Guaranteed by design, characterization or correlation to other tested parameters.
- The • denotes the specifications which apply over the full operating temperature range.

**3.3**

PART NUMBER DESIGNATOR	
Standard Military Drawing Number	Omnirel Part Number
8952101Y	OM1840SCM
8952101Z	OM1840NCM
8952101X	OM1840NKM
"Y" = Isolated "Z" = Non-Isolated	

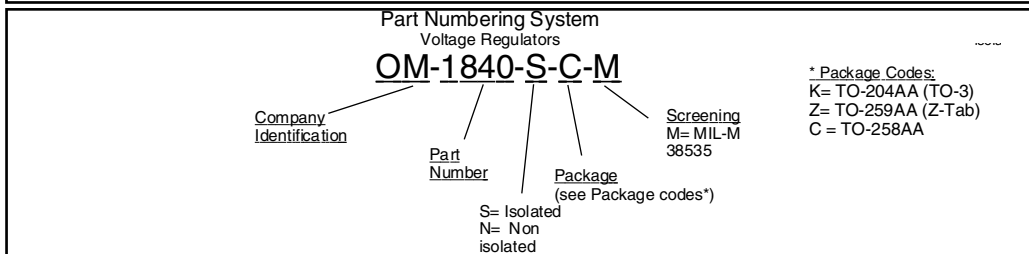

International Rectifier Companies  
The Hi-Rel Components & Subsystems Group

TYPICAL PERFORMANCE CHARACTERISTICS

LOAD REGULATION

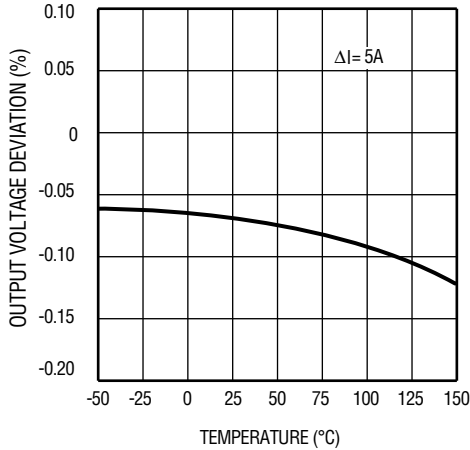

SHORT CIRCUIT CURRENT

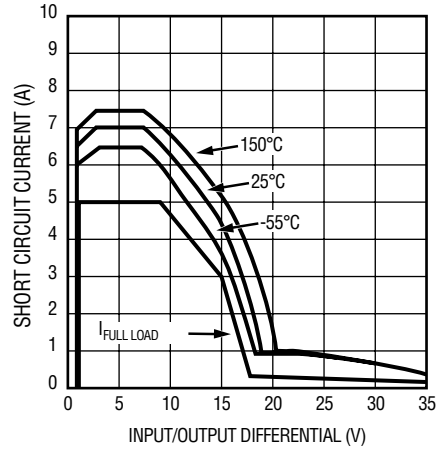

ADJUSTMENT PIN CURRENT

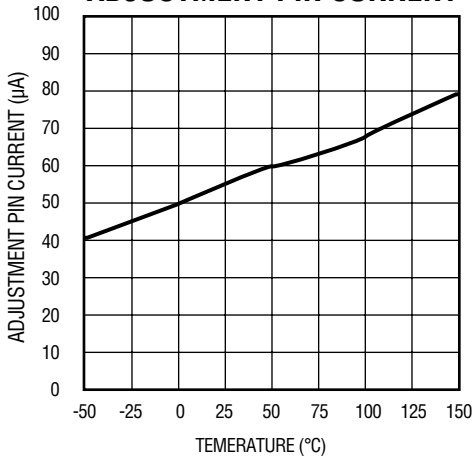

DROPOUT VOLTAGE

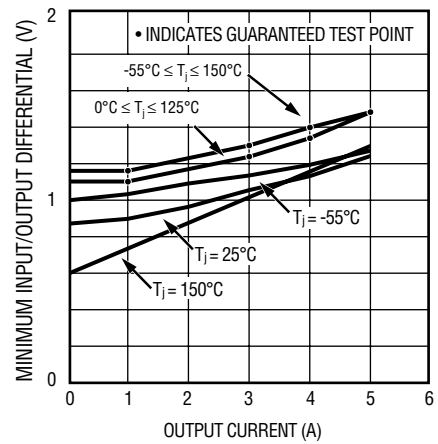

TEMPERATURE STABILITY

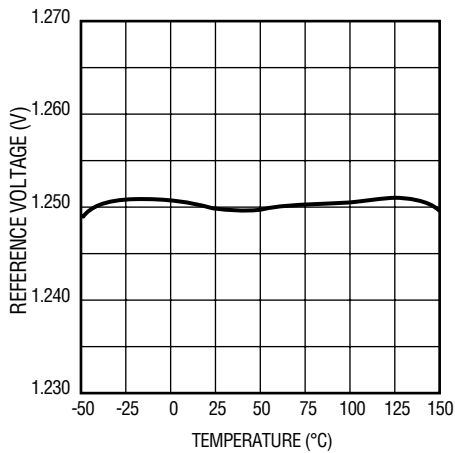

MINIMUM OPERATING CURRENT

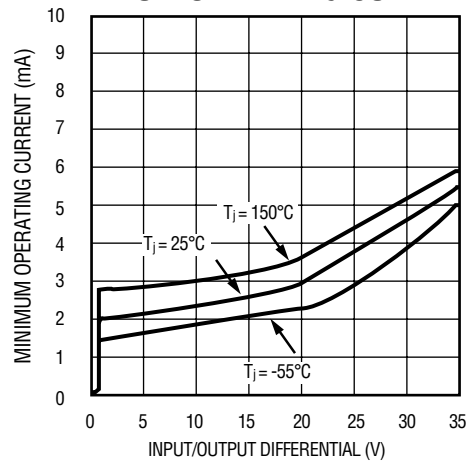

3.3

### TYPICAL APPLICATIONS

#### Parallel Regulators

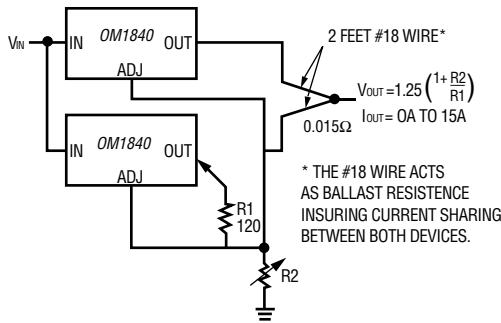

#### Improving Ripple Rejection

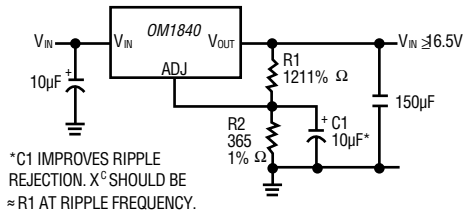

#### 1.2V - 15V Adjustable Regulator

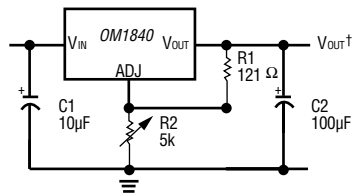

#### 5V Regulator with Shutdown

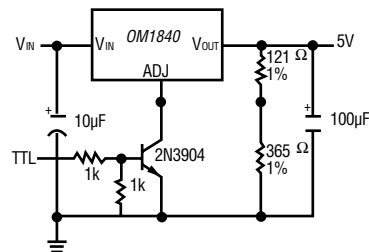

### MECHANICAL OUTLINE

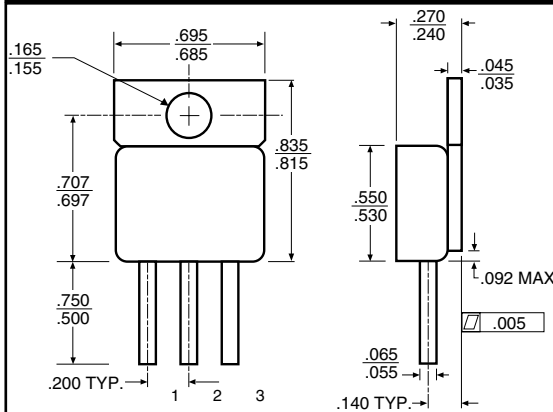

**PIN OUT**

1	Adjust
2	$V_{OUT}$
3	$V_{IN}$

### MECHANICAL OUTLINE TO-3

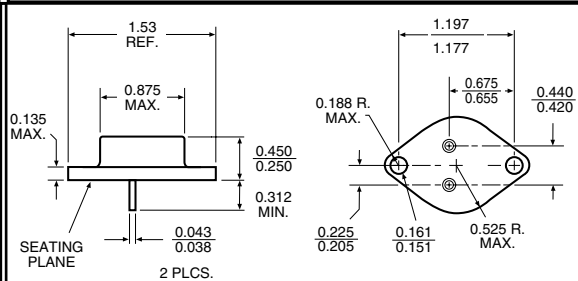

**PIN OUT**

1	Adjust
2	$V_{IN}$
Case	$V_{OUT}$

### NOTES

- Case is metal/hermetically sealed
- Isolated Tab

International Rectifier Companies  
 The Hi-Rel Components & Subsystems Group

